

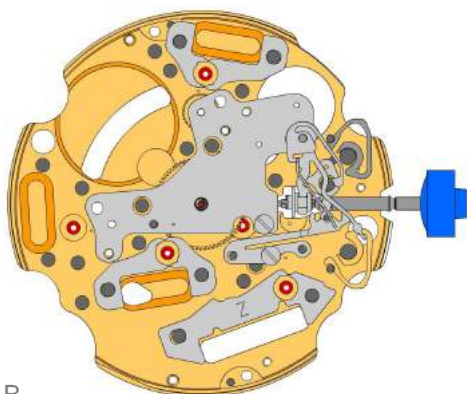



A



B

|                   |   |                                  |
|-------------------|---|----------------------------------|
| 2000.574.G<br>1.  |  | Platine                          |
| 3305.282.CO<br>2. |  | Chaussée avec entraîneur (Aig.2) |
| 3301.244<br>3.    |  | Roue des heures (cpt 24h)        |

|                   |   |   |
|-------------------|---|---|
| 2030.017.CO<br>4. |    | <b>Pont de centre</b><br>Pont de centre tenue par 1 vis 4000.250. Les pièces 2030.017.CO, 3004.223 et 3500.059 doivent être échangées ensemble. |
| 4000.250<br>5.    |    | Vis   |
| 3001.055.FI<br>6. |    | Pignon coulant  |
| 3000.177.CO<br>7. |    | Tige de mise à l'heure  |
| 3017.049<br>8.    |   | Tirette   |
| 3905.049<br>9.    |  | <b>Sautoir de tirette (3 positions)</b><br>Sautoir de tirette tenue par 1 vis 4000.250.   |
| 4000.250<br>10.   |  | Vis   |
| 3015.081<br>11.   |  | <b>Bascule (3 positions)</b><br>Les pièces 3015.081 et 3905.067 doivent être échangées ensemble.  |
| 3905.067<br>12.   |  | <b>Ressort de bascule</b><br>Mise en tension du ressort. Les pièces 3015.081 et 3905.067 doivent être échangées ensemble.                       |
| 3406.030<br>13.   |  | <b>Sautoir de poussoir B</b><br>Fixer le sautoir de poussoir gris entre les deux piliers plus loin.   |
| 3406.038<br>14.   |  | <b>Sautoir de poussoir A</b><br>Fixer le sautoir de poussoir jaune entre les deux piliers plus proche.  |
| 3622.040<br>15.   |  | <b>Stator</b><br>Marquage  Z  sur le stator.  |
| 3622.039<br>16.   |  | <b>Stator (cpt 6h, 9h, chrono)</b>  |
| 3622.039<br>17.   |  | <b>Stator (cpt 6h, 9h, chrono)</b>  |

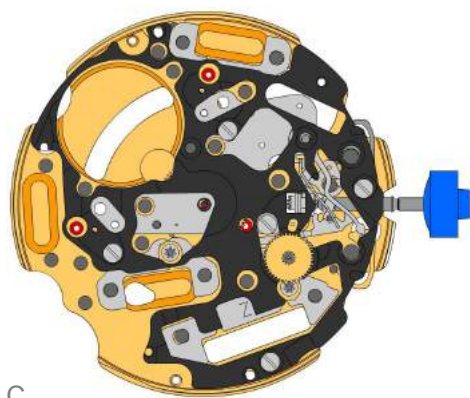
**C**

3603.079  
18.  **Potence plastique**  
Potence plastique tenue par 4 vis 4000.250.

4000.250  
19.  **Vis**

3715.094.RK  
20.  **Rotor**

3715.094.RK  
21.  **Rotor**

3147.046.CO  
22.  **Roue intermédiaire**

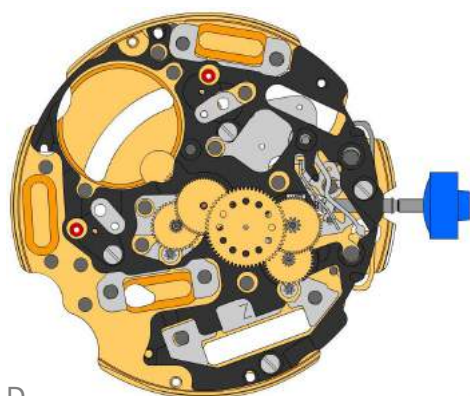

**D**

3136.148.CO  
23.  **Roue de seconde (courte)**

3147.047.CO  
24.  **Roue intermédiaire (chrono)**

3136.144.CO  
25.  **Roue de chronographe (Aig.2)**

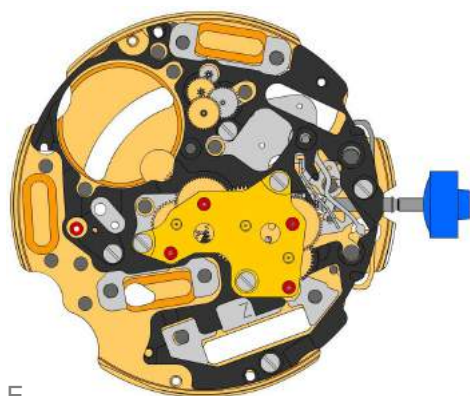
3122.056.CO  
26.  **Roue moyenne**

**E**

2020.148.G  
27.  **Pont de rouage**  
Pont de rouage tenue par 3 vis 4000.250.

4000.250  
28.  **Vis**

3715.095.RK  
29.  **Rotor**

3147.048.CO  
30.  **Roue intermédiaire (cpt)**

3007.056.CO  
31.  **Roue de minuterie (cpt 24h)**

3402.008.CO  
32.  **Roue compteuse de minutes (24h)**

2020.149.G  
33.  **Pont de rouage compteur**  
Pont de rouage compteur tenue par 3 vis 4000.250.

4000.250  
34.  **Vis**

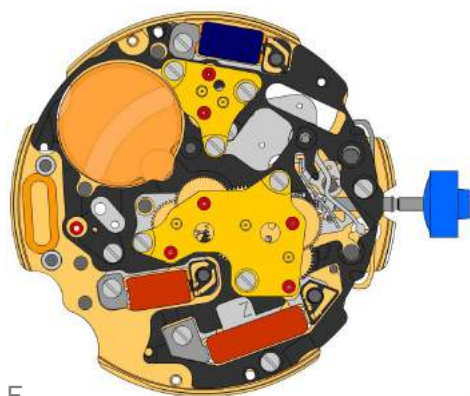
**F**

3621.053.RK  
35.  **Bobine**  
Attention: Prendre la bobine uniquement par le noyau de bobine gris.  
Bobine tenue par 1 vis 4000.250.

3621.079.RK  
36.  **Bobine (centre)**  
Attention: Prendre la bobine uniquement par le noyau de bobine gris.  
Bobine tenue par 1 vis 4000.250.

3621.055.RK  
37.  **Bobine (cpt 6h)**  
Attention: Prendre la bobine uniquement par le noyau de bobine gris.  
Bobine tenue par 1 vis 4000.250.

4000.250  
38.  **Vis**

3603.034  
39.  **Isolateur pile**

3503.071  
40.  **Tube**

3503.054  
41.  **Tube**

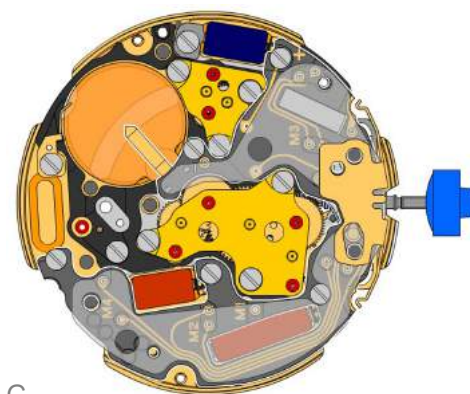
**G**

3601.118  
42.  **Bride contact**  
Bride contact tenue par 1 vis 4000.250.

4000.250  
43.  **Vis**

3612.144.5010  
44.  **Module électronique**  
Module électronique tenue par 5 vis 4000.248. Les mesures électroniques peuvent être réalisées maintenant.

4000.248  
45.  **Vis**

3603.069  
46.  **Isolateur de circuit**

3601.107.G  
47.  **Ressort contact poussoirs**

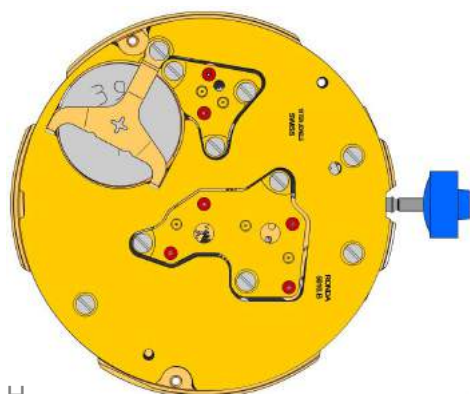
**H**

2130.139.G.M01.5010B  
48.  **Couvre-module électronique**  
Couvre-module électronique tenue par 3 vis 4000.250.

4000.250  
49.  **Vis**

3600.010.HGF  
50.  **Pile 395**





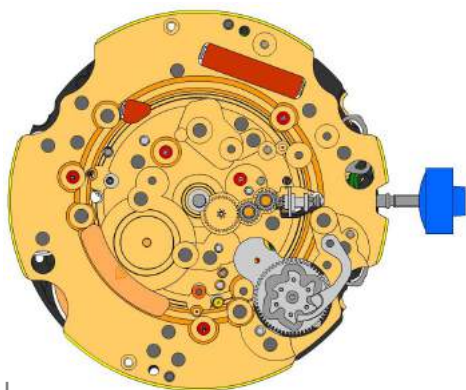

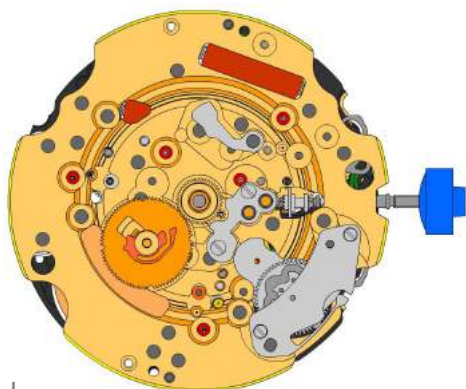

3601.109.G  
51.  **Bride +**  
Bride tenue par 1 vis 4000.250.

4000.250  
52.  **Vis**



|                    |   |  |
|--------------------|---|--|
| 2000.574.G<br>53.  |  | Platine  |
| 3004.164<br>54.    |  | Renvoi   |
| 3004.164<br>55.    |  | Renvoi   |
| 3007.054.CO<br>56. |  | Roue de minuterie  |
| 2130.143<br>57.    |  | Pont du rouage de minuterie<br>Pont du rouage de minuterie tenue par 2 vis 4000.305. |
| 4000.305<br>58.    |  | Vis  |

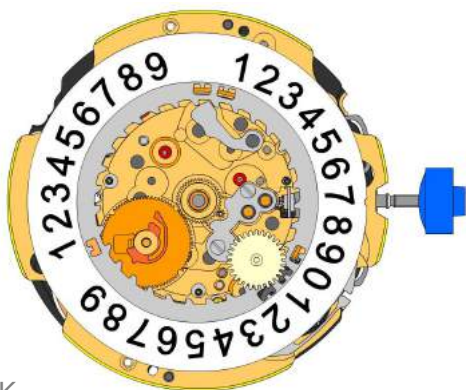

|                    |   |   |
|--------------------|---|---|
| 3004.223<br>59.    |    | <b>Roue entraîneuse des dizaines</b><br>Les pièces 2030.017.CO, 3004.223 et 3500.059 doivent être échangées ensemble. Positionnement de la dent courte de la roue entraîneuse des dizaines en direction le centre du mouvement. |
| 3500.059<br>60.    |   | <b>Sautoir des dizaines</b><br>Les pièces 2030.017.CO, 3004.223 et 3500.059 doivent être échangées ensemble.  |
| 2130.142<br>61.    |  | <b>Plaque de maintien du sautoir des dizaines</b><br>Plaque maintien sautoir des dizaines tenue par 2 vis 4000.306. Mise en tension du ressort.   |
| 4010.306<br>62.    |  | Vis   |
| 3301.242<br>63.    |  | Roue des heures (Aig.2)   |
| 3315.016<br>64.    |  | Clinquant   |
| 3004.224.CO<br>65. |  | Roue entraîneuse de quantième   |
| 3500.049<br>66.    |  | Sautoir de quantième  |

**K**

|                        |   |  |
|------------------------|---|--|
| 3504.214.AF.1.A<br>67. |  | Indicateur des unités (standard)<br>Marquage de l'indicateur à 3 heures.   |
| 3147.054<br>68.        |  | Roue intermédiaire dizaines  |
| 2130.141<br>69.        |  | Plaque de maintien de l'indicateur de quantième<br>Plaque maintien indicateur de quantième held by 1 screw 4000.250. |
| 3905.070<br>70.        |  | Ressort sautoir de quantième<br>Insertion du ressort sautoir de quantième dans l'ouverture.                          |

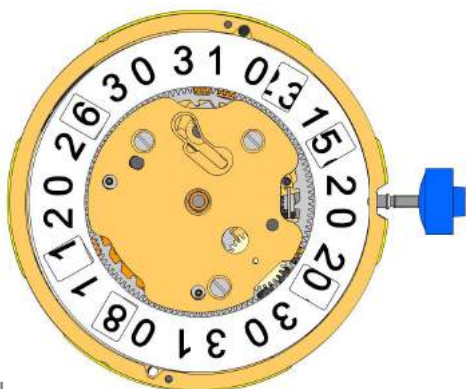
**L**

|                        |   |  |
|------------------------|---|--|
| 3504.216.AF.1.A<br>71. |    | Indicateur des dizaines (standard)<br>Marquage de l'indicateur à 3 heures.                                       |
| 2130.140.G<br>72.      |    | Plaque de maintien du mécanisme de quantième<br>Plaque maintien mécanisme de quantième tenue par 2 vis 4000.250. |
| 4000.250<br>73.        |    | Vis  |
| 3506.072.G<br>74.      |   | Support de cadran  |
| 9010.000<br>75.        |  | Moebius 8200   |
| 9014.000<br>76.        |  | Moebius 9014   |
| 9018.000<br>77.        |  | Jismaa 124   |
| 9020.000<br>78.        |  | Moebius 9020   |

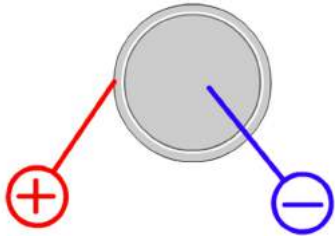

|         |               |
|---------|---------------|
| Pile    | <b>395</b>    |
| Tension | <b>1.55 V</b> |

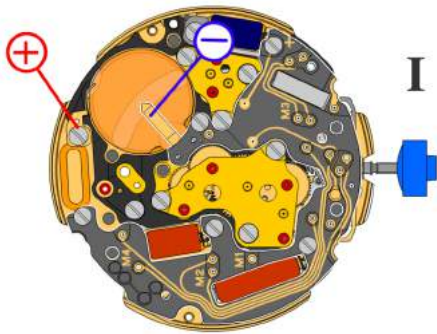

*Tige de mise à l'heure en position I, calendrier hors engrenage, intervalle de mesure 60 s pour la marche et la consommation:*

|   |                               |
|---|-------------------------------|
| Consommation typique                              | <b>1.32 <math>\mu</math>A</b> |
| Consommation maximale                             | <b>1.65 <math>\mu</math>A</b> |
| Marche  | <b>-10s/M. .. +20s/M.</b>     |
| Limite inférieure de la tension de fonctionnement | <b>1.20 V</b>                 |

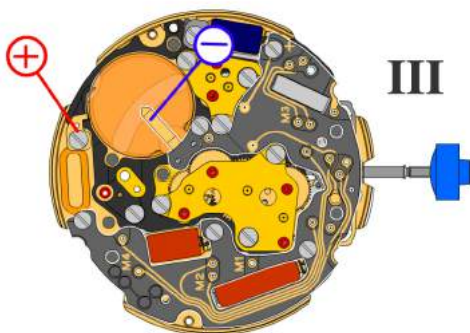

*Tige de mise à l'heure en position III, intervalle de mesure 60 s:*

|                     |                               |
|---------------------|-------------------------------|
| Typical consumption | <b>0.10 <math>\mu</math>A</b> |
| Maximal consumption | <b>0.30 <math>\mu</math>A</b> |

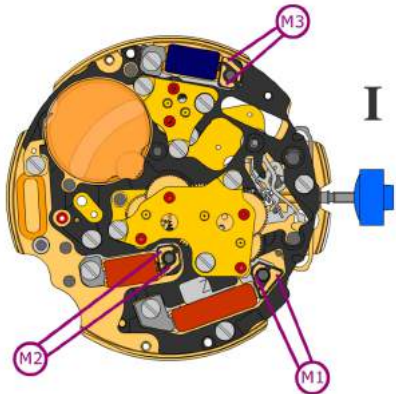

Résistance de la bobine M1      **1.90 k $\Omega$  .. 2.10 k $\Omega$**

Résistance de la bobine M2      **1.68 k $\Omega$  .. 1.88 k $\Omega$**

Résistance de la bobine M3      **1.68 k $\Omega$  .. 1.88 k $\Omega$**

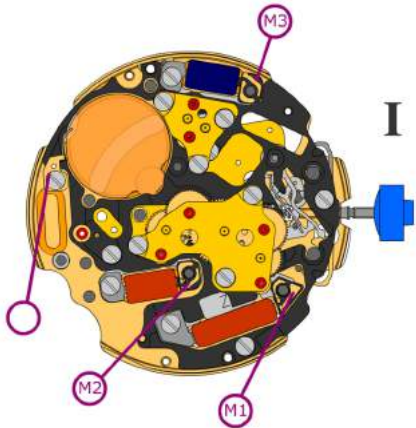

Isolation de la bobine M1/M2/M3       **$\infty$  k $\Omega$**

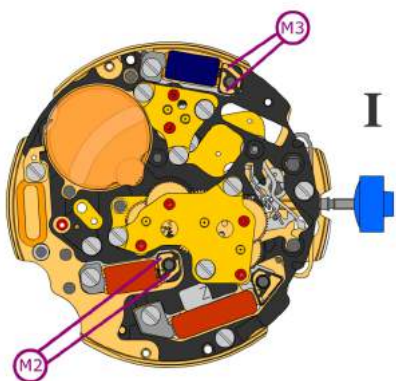

*Générateur d'impulsion*  
(4.9 ms, 8 Hz):



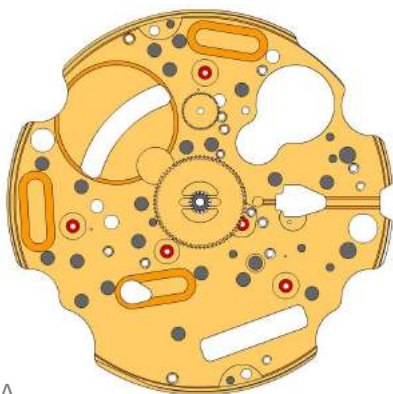



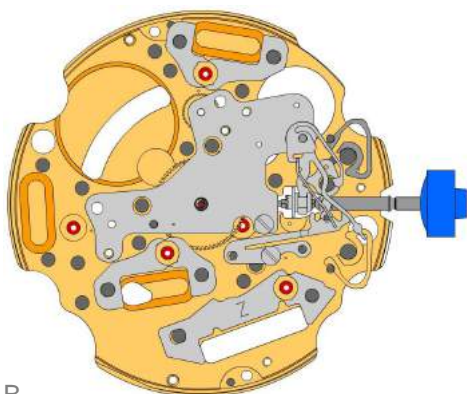





Limite inférieure de la tension de  
fonctionnement M2/M3      **1.20 V**



A







B

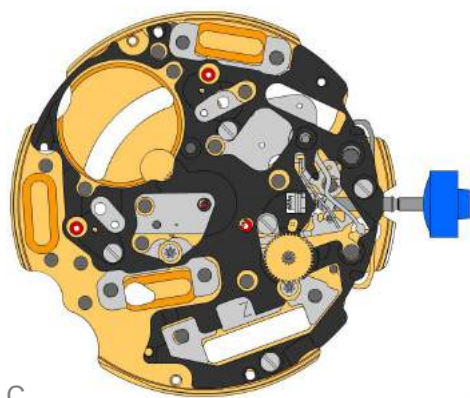



|                   |   |   |
|-------------------|---|---|
| 2000.574.G<br>1.  |    | Main plate  |
| 3305.282.CO<br>2. |    | Cannon pinion with driver (Aig.2)   |
| 3301.244<br>3.    |    | Hour wheel (counter 24h)  |
| 2030.017.CO<br>4. |    | Centre bridge<br>Centre bridge held by 1 screw 4000.250. Parts 2030.017.CO, 3004.223 and 3500.059 must be exchanged together. |
| 4000.250<br>5.    |    | Screw   |
| 3001.055.FI<br>6. |    | Sliding pinion  |
| 3000.177.CO<br>7. |    | Setting stem  |
| 3017.049<br>8.    |   | Setting lever   |
| 3905.049<br>9.    |  | Setting lever jumper (3 positions)<br>Setting lever jumper held by 1 screw 4000.250.  |
| 4000.250<br>10.   |  | Screw   |
| 3015.081<br>11.   |  | Yoke (3 positions)<br>Parts 3015.081 and 3905.067 must be exchanged together.   |
| 3905.067<br>12.   |  | Yoke spring<br>Tensioning the spring arm. Parts 3015.081 and 3905.067 must be exchanged together.                             |
| 3406.030<br>13.   |  | Pusher jumper B<br>Put the grey jumper between the two posts on the further side.   |
| 3406.038<br>14.   |  | Pusher jumper A<br>Put the yellow jumper between the two posts on the closer side.  |
| 3622.040<br>15.   |  | Stator<br>Mark  Z  on stator.   |
| 3622.039<br>16.   |  | Stator (counter 6h, 9h, chrono)   |
| 3622.039<br>17.   |  | Stator (counter 6h, 9h, chrono)   |



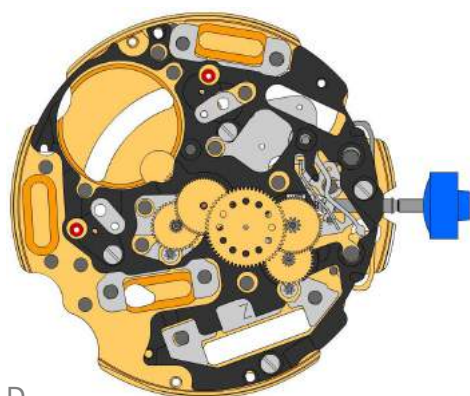







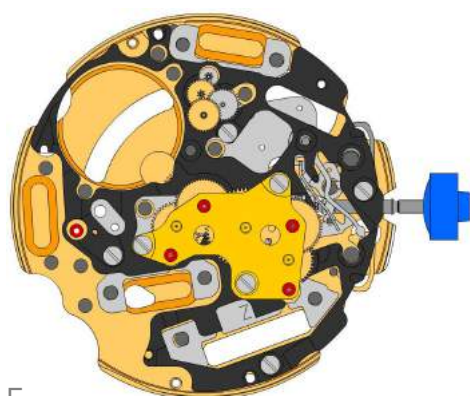

**C**

|                    |   |  |
|--------------------|---|--|
| 3603.079<br>18.    |  | <b>Plastic bracket</b><br>Plastic bracket held by 4 screws 4000.250. |
| 4000.250<br>19.    |  | <b>Screw</b>   |
| 3715.094.RK<br>20. |  | <b>Rotor</b>   |
| 3715.094.RK<br>21. |  | <b>Rotor</b>   |
| 3147.046.CO<br>22. |  | <b>Intermediate wheel</b>  |

**D**

|                    |   |                                    |
|--------------------|---|------------------------------------|
| 3136.148.CO<br>23. |    | <b>Second wheel (short)</b>        |
| 3147.047.CO<br>24. |    | <b>Intermediate wheel (chrono)</b> |
| 3136.144.CO<br>25. |   | <b>Chronograph wheel (Aig.2)</b>   |
| 3122.056.CO<br>26. |  | <b>Third wheel</b>                 |

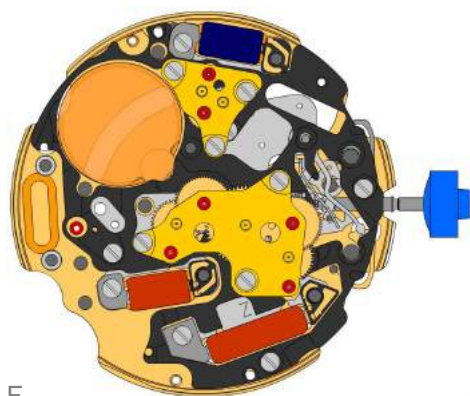

**E**

|                    |   |  |
|--------------------|---|--|
| 2020.148.G<br>27.  |  | <b>Train wheel bridge</b><br>Train wheel bridge held by 3 screws 4000.250.                 |
| 4000.250<br>28.    |  | <b>Screw</b>   |
| 3715.095.RK<br>29. |  | <b>Rotor</b>   |
| 3147.048.CO<br>30. |  | <b>Intermediate wheel (counter)</b>  |
| 3007.056.CO<br>31. |  | <b>Minute wheel (counter 24h)</b>  |
| 3402.008.CO<br>32. |  | <b>Minute counting wheel (24h)</b>   |
| 2020.149.G<br>33.  |  | <b>Counter train wheel bridge</b><br>Counter train wheel bridge held by 3 screws 4000.250. |
| 4000.250<br>34.    |  | <b>Screw</b>   |



F

3621.053.RK  
35.  **Coil**  
Attention: Please hold the coil only on the grey coil core. Coil held by 1 screw 4000.250.

3621.079.RK  
36.  **Coil (centre)**  
Attention: Please hold the coil only on the grey coil core. Coil held by 1 screw 4000.250.

3621.055.RK  
37.  **Coil (counter 6h)**  
Attention: Please hold the coil only on the grey coil core. Coil held by 1 screw 4000.250.

4000.250  
38.  **Screw**

3603.034  
39.  **Battery insulator**

3503.071  
40.  **Tube**

3503.054  
41.  **Tube**

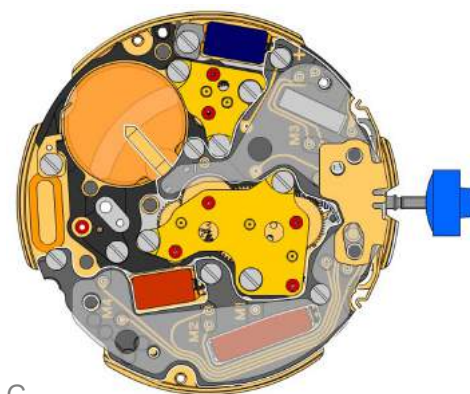

G

3601.118  
42.  **Contact strip**  
Contact strip held by 1 screw 4000.250.

4000.250  
43.  **Screw**

3612.144.5010  
44.  **Electronic module**  
Electronic module held by 5 screws 4000.248. Electronic measurements may be realised now.

4000.248  
45.  **Screw**

3603.069  
46.  **Circuit insulator**

3601.107.G  
47.  **Pusher contact spring**

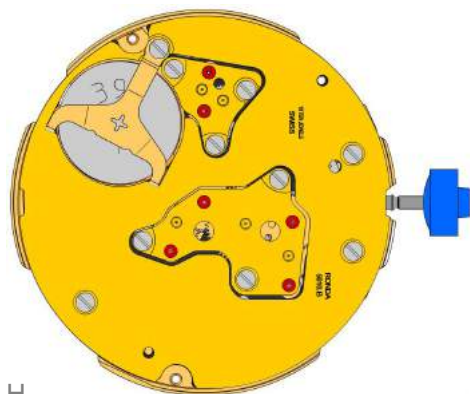



H

2130.139.G.M01.5010B  
48.  **Electronic module cover**  
Electronic module cover held by 3 screws 4000.250.





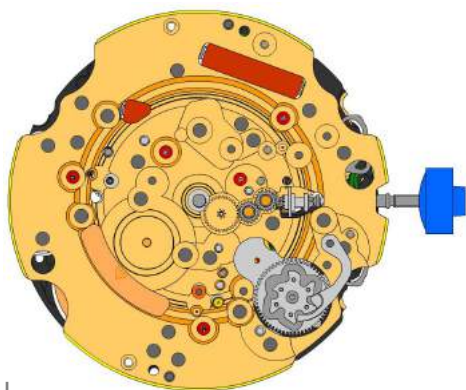

4000.250  
49.  **Screw**

3600.010.HGF  
50.  **Battery 395**







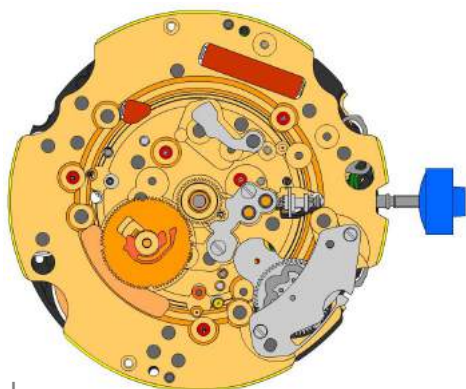

3601.109.G  
51.  **Bridle +**  
Bridle held by 1 screw 4000.250.

4000.250  
52.  **Screw**





**I**



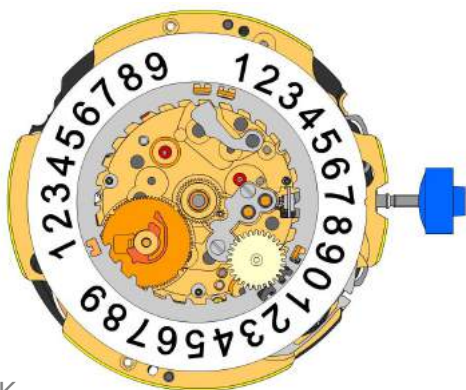
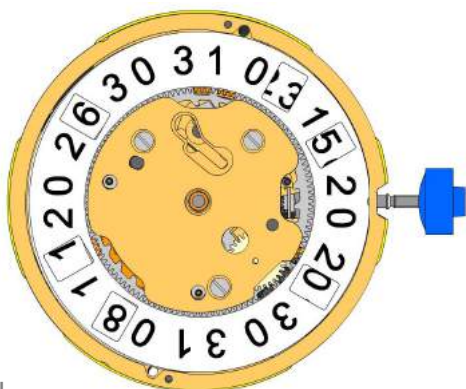

|                    |   |   |
|--------------------|---|---|
| 2000.574.G<br>53.  |  | Main plate  |
| 3004.164<br>54.    |  | Setting wheel   |
| 3004.164<br>55.    |  | Setting wheel   |
| 3007.054.CO<br>56. |  | Minute wheel  |
| 2130.143<br>57.    |  | Minute train bridge<br>Minute train bridge held by 2 screws 4000.305. |
| 4000.305<br>58.    |  | Screw   |





**J**

|                    |   |  |
|--------------------|---|--|
| 3004.223<br>59.    |    | Tens indicator driving wheel<br>Parts 2030.017.CO, 3004.223 and 3500.059 must be exchanged together. The short tooth of the tens indicator driving wheel must point to the center of the movement. |
| 3500.059<br>60.    |   | Tens jumper<br>Parts 2030.017.CO, 3004.223 and 3500.059 must be exchanged together.  |
| 2130.142<br>61.    |  | Tens jumper maintaining plate<br>Tens jumper maintaining plate held by 2 screws 4000.306. Tensioning the spring arm.   |
| 4010.306<br>62.    |  | Screw  |
| 3301.242<br>63.    |  | Hour wheel (Fig.2)   |
| 3315.016<br>64.    |  | Friction spring  |
| 3004.224.CO<br>65. |  | Date indicator driving wheel   |
| 3500.049<br>66.    |  | Date jumper  |

**K**

**L**

|                        |   |   |
|------------------------|---|---|
| 3504.214.AF.1.A<br>67. |  | <b>Units indicator (standard)</b><br>Nick of the indicator at 3 o'clock.                              |
| 3147.054<br>68.        |  | <b>Tens intermediate wheel</b>  |
| 2130.141<br>69.        |  | <b>Date indicator maintaining plate</b><br>Date indicator maintaining plate held by 1 screw 4000.250. |
| 3905.070<br>70.        |  | <b>Date jumper spring</b><br>Insert the date jumper spring in the provided opening.                   |

|                        |  |  |
|------------------------|--|--|
| 3504.216.AF.1.A<br>71. |   | <b>Tens indicator (standard)</b><br>Nick of the indicator at 3 o'clock.                                |
| 2130.140.G<br>72.      |   | <b>Date mechanism maintaining plate</b><br>Date mechanism maintaining plate held by 2 screws 4000.250. |
| 4000.250<br>73.        |   | <b>Screw</b>   |
| 3506.072.G<br>74.      |  | <b>Dial support</b>  |

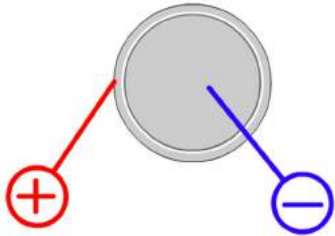
|                 |   |                     |
|-----------------|---|---------------------|
| 9010.000<br>75. |  | <b>Moebius 8200</b> |
| 9014.000<br>76. |  | <b>Moebius 9014</b> |
| 9018.000<br>77. |  | <b>Jismaa 124</b>   |
| 9020.000<br>78. |  | <b>Moebius 9020</b> |



|         |               |
|---------|---------------|
| Battery | <b>395</b>    |
| Voltage | <b>1.55 V</b> |

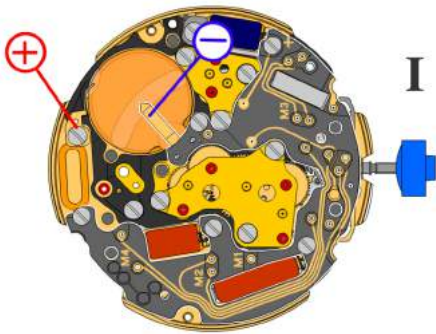

*Setting stem in position I, calendar not in gear,  
60 s measuring interval for rate and consumption:*

|                             |                               |
|-----------------------------|-------------------------------|
| Typical consumption         | <b>1.32 <math>\mu</math>A</b> |
| Maximal consumption         | <b>1.65 <math>\mu</math>A</b> |
| Rate                        | <b>-10s/M. .. +20s/M.</b>     |
| Lower working voltage limit | <b>1.20 V</b>                 |

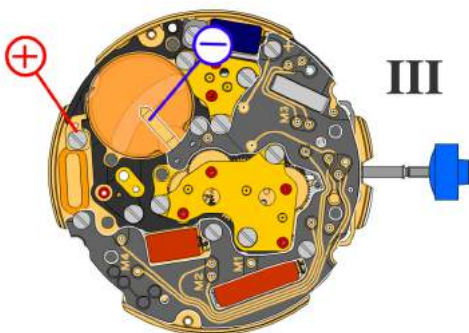

*Setting stem in position III, 60 s measuring interval:*

|                     |                               |
|---------------------|-------------------------------|
| Typical consumption | <b>0.10 <math>\mu</math>A</b> |
| Maximal consumption | <b>0.30 <math>\mu</math>A</b> |

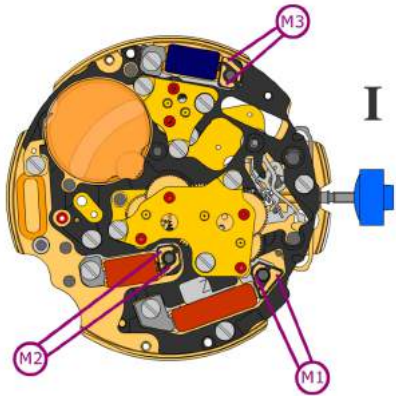

Coil resistance M1 **1.90 k $\Omega$  .. 2.10 k $\Omega$**

Coil resistance M2 **1.68 k $\Omega$  .. 1.88 k $\Omega$**

Coil resistance M3 **1.68 k $\Omega$  .. 1.88 k $\Omega$**

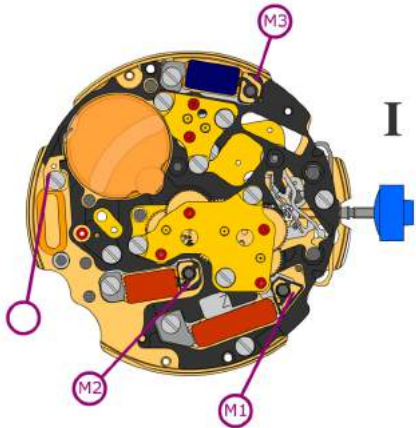

Coil isolation M1/M2/M3  **$\infty$  k $\Omega$**

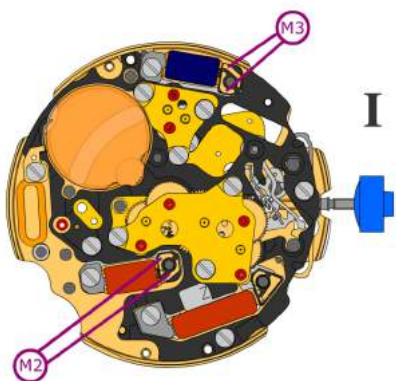

*Signal generator (4.9 ms, 8 Hz):*



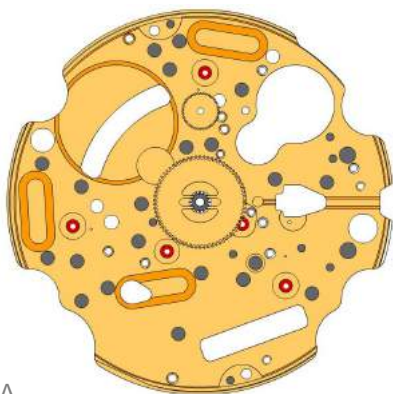



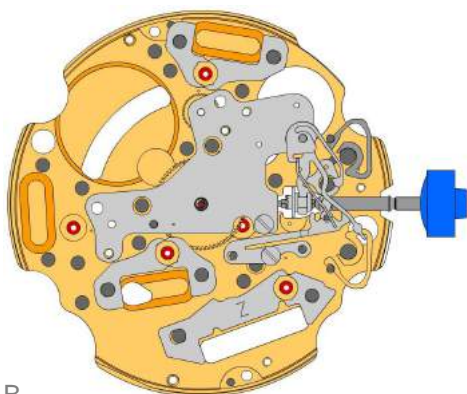

Lower working voltage limit M2/M3 **1.20 V**



A





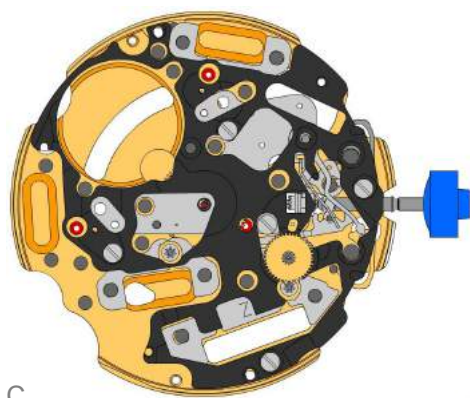

B

|                   |   |   |
|-------------------|---|---|
| 2000.574.G<br>1.  |    | Werkplatte  |
| 3305.282.CO<br>2. |    | Minutenrohr mit Mitnehmer (Aig.2)   |
| 3301.244<br>3.    |    | Stundenrad (Zähler 24h)   |
| 2030.017.CO<br>4. |    | <b>Zentrumbrücke</b><br>Zentrumbrücke gehalten durch 1 Schraube 4000.250. Die Teile 2030.017.CO, 3004.223 und 3500.059 sind zusammen auszutauschen. |
| 4000.250<br>5.    |    | Schraube  |
| 3001.055.FI<br>6. |    | Kupplungstrieb  |
| 3000.177.CO<br>7. |    | Stellwelle  |
| 3017.049<br>8.    |   | Winkelhebel   |
| 3905.049<br>9.    |  | <b>Winkelhebelraste (3 Positionen)</b><br>Winkelhebelraste gehalten durch 1 Schraube 4000.250.  |
| 4000.250<br>10.   |  | Schraube  |
| 3015.081<br>11.   |  | <b>Wippe (3 Positionen)</b><br>Die Teile 3015.081 und 3905.067 sind zusammen auszutauschen.   |
| 3905.067<br>12.   |  | <b>Wippenfeder</b><br>Den Federarm spannen. Die Teile 3015.081 und 3905.067 sind zusammen auszutauschen.  |
| 3406.030<br>13.   |  | <b>Drückerraste B</b><br>Graue Drückerraste zwischen den beiden Säulen auf der entfernteren Seite platzieren.                                       |
| 3406.038<br>14.   |  | <b>Drückerraste A</b><br>Gelbe Drückerraste zwischen den beiden Säulen auf der näheren Seite platzieren.  |
| 3622.040<br>15.   |  | <b>Stator</b><br>Markierung [Z] auf Stator.   |
| 3622.039<br>16.   |  | Stator (Zähler 6h, 9h, Chrono)  |
| 3622.039<br>17.   |  | Stator (Zähler 6h, 9h, Chrono)  |



C

|                    |   |  |
|--------------------|---|--|
| 3603.079<br>18.    |  | <b>Kunststoffhalterung</b><br>Kunststoffhalterung gehalten durch 4 Schrauben 4000.250. |
| 4000.250<br>19.    |  | Schraube   |
| 3715.094.RK<br>20. |  | Rotor  |
| 3715.094.RK<br>21. |  | Rotor  |
| 3147.046.CO<br>22. |  | Zwischenrad  |

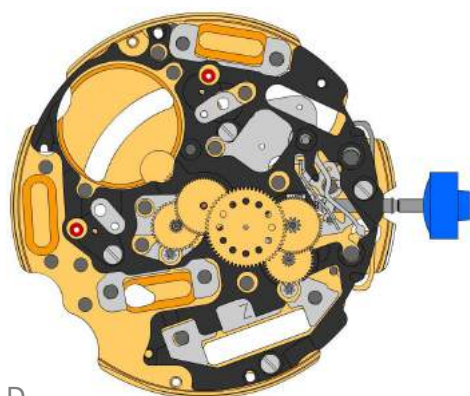

D

|                    |   |                           |
|--------------------|---|---------------------------|
| 3136.148.CO<br>23. |    | Sekundenrad (kurz)        |
| 3147.047.CO<br>24. |    | Zwischenrad (Chrono)      |
| 3136.144.CO<br>25. |   | Chrono-Zentrumrad (Aig.2) |
| 3122.056.CO<br>26. |  | Kleinbodenrad             |

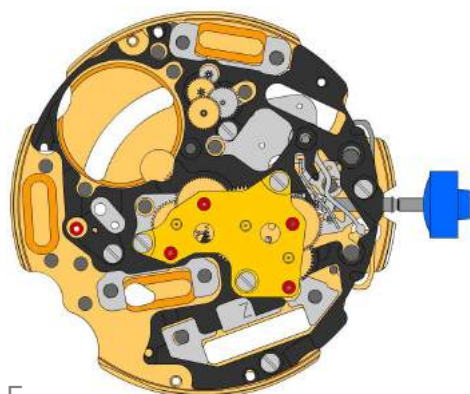

E

|                    |   |  |
|--------------------|---|--|
| 2020.148.G<br>27.  |  | <b>Räderwerkbrücke</b><br>Räderwerkbrücke gehalten durch 3 Schrauben 4000.250.               |
| 4000.250<br>28.    |  | Schraube   |
| 3715.095.RK<br>29. |  | Rotor  |
| 3147.048.CO<br>30. |  | Zwischenrad (Zähler)   |
| 3007.056.CO<br>31. |  | Wechselrad (Zähler 24h)  |
| 3402.008.CO<br>32. |  | Minutenzählrad (24h)   |
| 2020.149.G<br>33.  |  | <b>Zähler-Räderwerkbrücke</b><br>Zähler-Räderwerkbrücke gehalten durch 3 Schrauben 4000.250. |
| 4000.250<br>34.    |  | Schraube   |



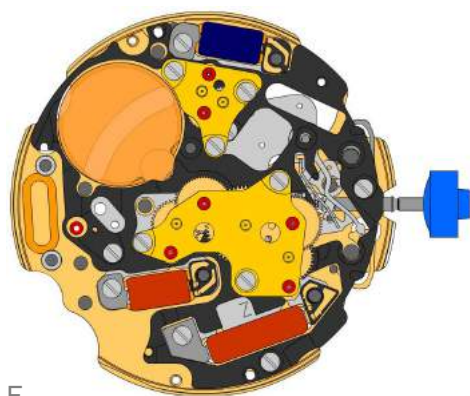



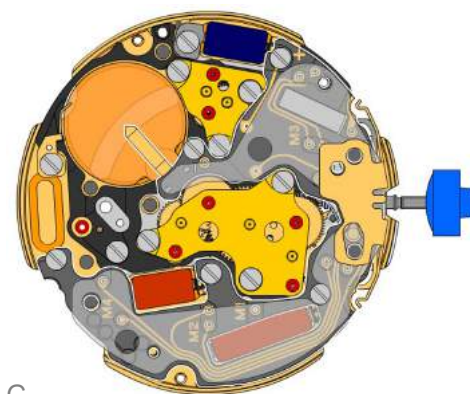



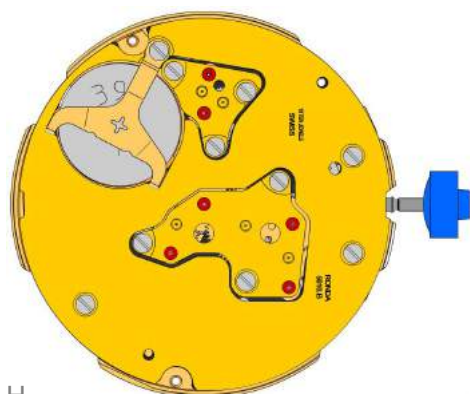











F



G







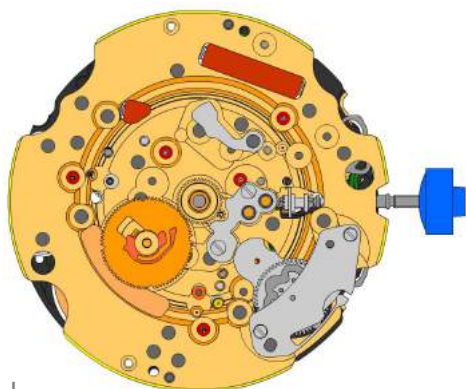
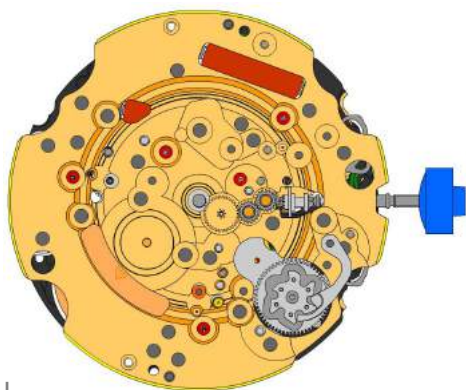



H

|                             |   |   |
|-----------------------------|---|---|
| 3621.053.RK<br>35.          |    | <b>Spule</b><br>Achtung: Spule nur am grauen Spulenkern halten. Spule gehalten durch 1 Schraube 4000.250.                             |
| 3621.079.RK<br>36.          |    | <b>Spule (Zentrum)</b><br>Achtung: Spule nur am grauen Spulenkern halten. Spule gehalten durch 1 Schraube 4000.250.                   |
| 3621.055.RK<br>37.          |    | <b>Spule (Zähler 6h)</b><br>Achtung: Spule nur am grauen Spulenkern halten. Spule gehalten durch 1 Schraube 4000.250.                 |
| 4000.250<br>38.             |    | <b>Schraube</b>   |
| 3603.034<br>39.             |    | <b>Isolation für Batterie</b>   |
| 3503.071<br>40.             |    | <b>Lagerrohr</b>  |
| 3503.054<br>41.             |    | <b>Lagerrohr</b>  |
| 3601.118<br>42.             |  | <b>Kontaktbügel</b><br>Kontaktbügel gehalten durch 1 Schraube 4000.250.   |
| 4000.250<br>43.             |  | <b>Schraube</b>   |
| 3612.144.5010<br>44.        |  | <b>Elektronikmodul</b><br>Elektronikmodul gehalten durch 5 Schrauben 4000.248. Elektronische Messungen können nun vorgenommen werden. |
| 4000.248<br>45.             |  | <b>Schraube</b>   |
| 3603.069<br>46.             |  | <b>Isolation für Schaltung</b>  |
| 3601.107.G<br>47.           |  | <b>Drückerkontaktfeder</b>  |
| 2130.139.G.M01.5010B<br>48. |  | <b>Deckplatte für Elektronikmodul</b><br>Deckplatte für Elektronikmodul gehalten durch 3 Schrauben 4000.250.                          |
| 4000.250<br>49.             |  | <b>Schraube</b>   |
| 3600.010.HGF<br>50.         |  | <b>Batterie 395</b>   |
| 3601.109.G<br>51.           |  | <b>Bügel +</b><br>Bügel gehalten durch 1 Schraube 4000.250.   |
| 4000.250<br>52.             |  | <b>Schraube</b>   |



|                    |   |   |
|--------------------|---|---|
| 2000.574.G<br>53.  |  | Werkplatte  |
| 3004.164<br>54.    |  | Zeigerstellrad  |
| 3004.164<br>55.    |  | Zeigerstellrad  |
| 3007.054.CO<br>56. |  | Wechselrad  |
| 2130.143<br>57.    |  | Wechselradbrücke<br>Wechselradbrücke gehalten durch 2 Schrauben 4000.305. |
| 4000.305<br>58.    |  | Schraube  |

|                    |   |   |
|--------------------|---|---|
| 3004.223<br>59.    |    | <b>Zehnermitnehmerrad</b><br>Die Teile 2030.017.CO, 3004.223 und 3500.059 sind zusammen auszutauschen. Kurzer Zahn des Zehnermitnehmerrades in Richtung Werkszentrum positionieren. |
| 3500.059<br>60.    |   | <b>Zehneraste</b><br>Die Teile 2030.017.CO, 3004.223 und 3500.059 sind zusammen auszutauschen.  |
| 2130.142<br>61.    |  | <b>Halteplatte für Zehneraste</b><br>Halteplatte für Zehneraste gehalten durch 2 Schrauben 4000.306. Den Federarm spannen.  |
| 4010.306<br>62.    |  | Schraube  |
| 3301.242<br>63.    |  | Stundenrad (Aig.2)  |
| 3315.016<br>64.    |  | Frikionsfeder   |
| 3004.224.CO<br>65. |  | Datumanzeiger-Mitnehmerrad  |
| 3500.049<br>66.    |  | Datumraste  |

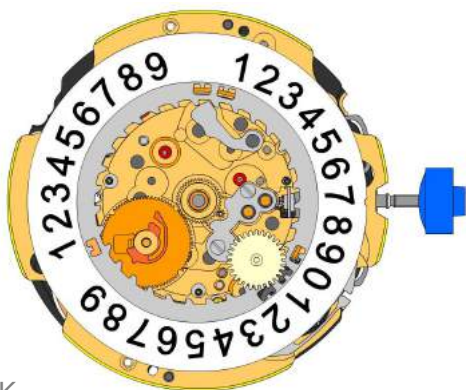





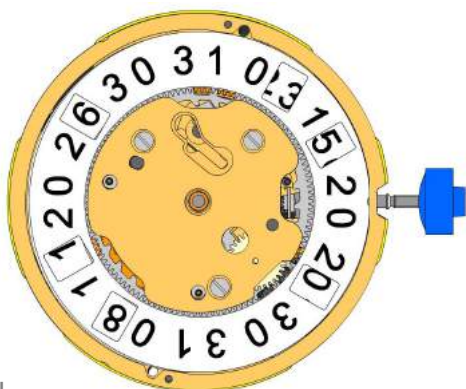



K

|                        |   |  |
|------------------------|---|--|
| 3504.214.AF.1.A<br>67. |  | Einer Anzeiger (Standard)<br>Einbuchtung im Disc bei 3 Uhr.                                      |
| 3147.054<br>68.        |  | Zehnerzwischenrad  |
| 2130.141<br>69.        |  | Halteplatte für Datumanzeige<br>Halteplatte für Datumanzeige gehalten durch 1 Schraube 4000.250. |
| 3905.070<br>70.        |  | Feder für Datumraste<br>Feder für Datumsraste in die Öffnung einfügen.                           |



L

|                        |   |   |
|------------------------|---|---|
| 3504.216.AF.1.A<br>71. |    | Zehner Anzeiger (Standard)<br>Einbuchtung im Disc bei 3 Uhr.  |
| 2130.140.G<br>72.      |    | Halteplatte für Datum-Mechanismus<br>Halteplatte für Datum-Mechanismus gehalten durch 2 Schrauben 4000.250. |
| 4000.250<br>73.        |    | Schraube  |
| 3506.072.G<br>74.      |   | Träger für Zifferblatt  |
| 8200<br>75.            |  | Moebius 8200  |
| 9014<br>76.            |  | Moebius 9014  |
| 124<br>77.             |  | Jismaa 124  |
| 9020<br>78.            |  | Moebius 9020  |

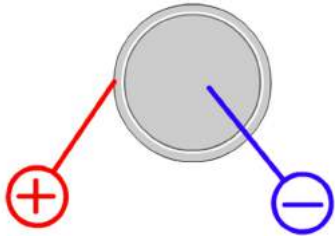

|          |               |
|----------|---------------|
| Batterie | <b>395</b>    |
| Spannung | <b>1.55 V</b> |

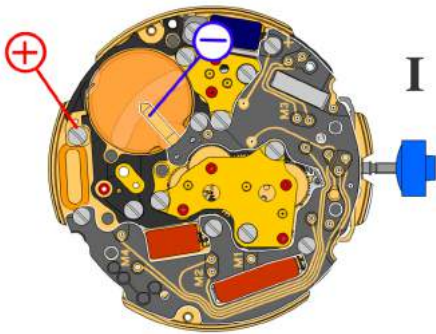

*Stellwelle in Position I, Kalender nicht im Eingriff,  
60 s Messintervall für Gang und Verbrauch:*

|                                 |                               |
|---------------------------------|-------------------------------|
| Typischer Verbrauch             | <b>1.32 <math>\mu</math>A</b> |
| Maximaler Verbrauch             | <b>1.65 <math>\mu</math>A</b> |
| Gang                            | <b>-10s/M. .. +20s/M.</b>     |
| Untere Funktionsspannungsgrenze | <b>1.20 V</b>                 |

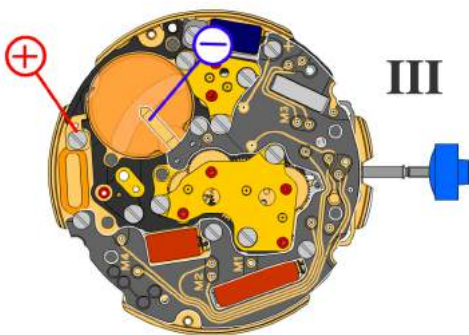

*Stellwelle in Position III, 60 s Messintervall:*

|                     |                               |
|---------------------|-------------------------------|
| Typischer Verbrauch | <b>0.10 <math>\mu</math>A</b> |
| Maximaler Verbrauch | <b>0.30 <math>\mu</math>A</b> |

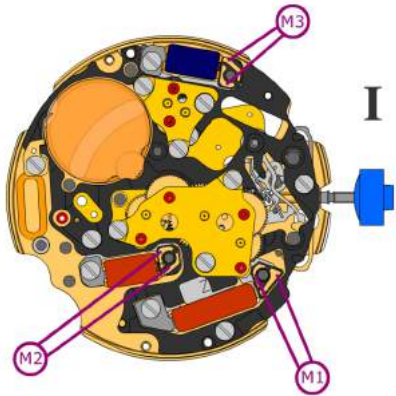

Spulenwiderstand M1 **1.90 k $\Omega$  .. 2.10 k $\Omega$**

Spulenwiderstand M2 **1.68 k $\Omega$  .. 1.88 k $\Omega$**

Spulenwiderstand M3 **1.68 k $\Omega$  .. 1.88 k $\Omega$**

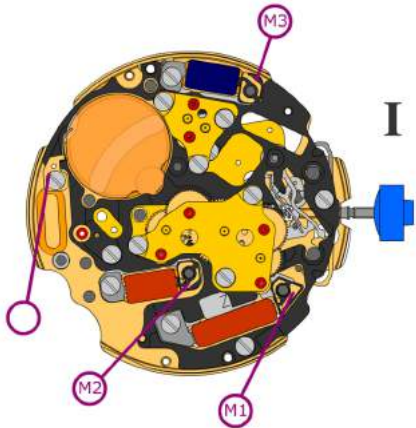

Spulenisolation M1/M2/M3  **$\infty$  k $\Omega$**

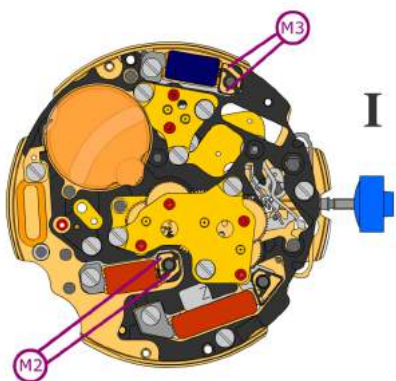

*Pulsgenerator (4.9 ms, 8 Hz):*

Untere Funktionsspannungsgrenze M2/M3 **1.20 V**