

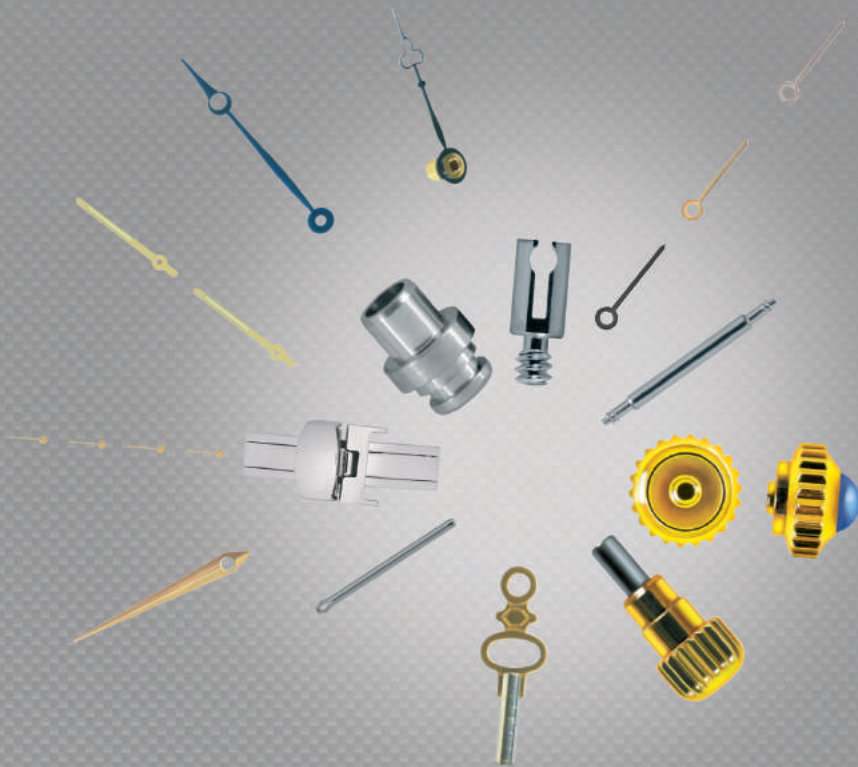















Watch Parts Service



2018

Index alphabétique Alphabetical index Aphabetisches Inhaltsverzeichnis
Índice alfabético Índice alfabético Índice alfabético

	Joints <i>Gaskets</i> Dichtungen <i>Juntas</i> Guarnizioni <i>Juntas</i>	22 pages
	Barrettes <i>Spring bars</i> Federstege <i>Pasadores</i> Anse <i>Pinos</i>	64 pages
	Goupilles <i>Pins</i> Stiften <i>Grupillas</i> Coppiglie <i>Cavilhas</i>	22 pages
	Aiguilles <i>Hands</i> Zeiger <i>Agujas</i> Lancette <i>Ponteiros</i>	18 pages
	Couronnes <i>Crowns</i> Kronen <i>Coronas</i> Corone <i>Coroas</i>	72 pages
	Tubes <i>Tubes</i> Röhre <i>Tubos</i> Tubi <i>Tubos</i>	8 pages
	Poussoirs <i>Pushers</i> Drücker <i>Pulsadores</i> Pulsanti <i>Botões</i>	14 pages
	Rallongeurs/Tiges/Quartz <i>Extenders/Stems/Quartz</i> Verlängerungen/ Wellen/Quarz <i>Alargadores/Tijas/Cuarzo</i> Prolunghe/Alberi/Quarzo <i>Acrescentadores/Tiges/Quartzo</i>	8 pages
	Pieds de cadran/Vis pour fonds <i>Dial feet/Screws for case backs</i> Zifferblatffüße/ Schrauben für Gehäuseböden <i>Pies de esfera/Tornillos para fondos</i> Piedini di quadrante/Viti per fondi <i>Pés de mostrador/Parafusos para fundos</i>	6 pages
	Fermeurs <i>Clasps</i> Schliessen <i>Cierres</i> Chiusure <i>Fechos</i>	10 pages
	Verres <i>Crystals</i> Gläsern <i>Cristales</i> Vetri <i>Vidros</i>	18 pages
	Protections <i>Protections</i> Schutz <i>Protecciones</i> Protezioni <i>Protecções</i>	6 pages
	Kits pour assemblage <i>Watch assembly kits</i> Kits für Uhrenmontage <i>Kits para montaje</i> Kit per l'assemblaggio <i>Kits para montagem</i>	10 pages
	Pendulerie <i>Clock parts</i> Pendeluhr <i>Pendulería</i> Pendoleria <i>Pêndularia</i>	16 pages
	Piles <i>Batteries</i> Batterien <i>Baterías</i> Batterie <i>Pilhas</i>	10 pages

Index numérique Numerical index Numerisches Inhaltsverzeichnis
Índice numérico Índice numerico Índice numérico

Aiguilles	4-1 ... 4-17
- pour montres	4-2
- pour montres anciennes	4-14

Barrettes	2-1 ... 2-64
- à pression	2-46
- à vis	2-55
- de sécurité	2-4
- femelles	2-44
- pour fermoirs	2-35
- simples	2-29
- spéciales	2-41
- universelles	2-26

Couronnes	5-1 ... 5-71
- à vis	5-41
- antipoussière	5-8
- antipoussière demi-boule	5-12
- de marque	5-66
- de travail	5-71
- étanches	5-14
- étanches demi-boule	5-34
- japonaises	5-39
- pour montres de poche	5-47
- simples	5-4

Fermeurs pour bracelets	10-1 ... 10-9
--------------------------------	----------------------

Goupilles	3-1 ... 3-22
- avec encoche	3-20
- coniques	3-22
- fendues	3-2
- moletées	3-12

Joints	1-1 ... 1-21
- divers	1-15
- mini O-Ring	1-13
- plats	1-2
- pour verres	11-15
- ronds	1-6
- rouges	1-20

Kits pour l'assemblage de montres	14-1 ... 14-10
--	-----------------------

Pendulerie	15-1 ... 15-15
- chiffres	15-13
- clés pour pendules et montres de poche	15-2
- goupilles coniques	15-4
- gouttes	15-4

- rondelles	15-5
- suspensions	15-6

Pieds de cadran	9-2
------------------------	------------

Piles	16-1 ... 16-10
- accumulateurs	16-6
- adaptateurs de piles	16-5
- brides de fixation de pile	16-10
- piles	16-2

Poussoirs	7-1 ... 7-13
- à chasser	7-2
- à visser	7-10
- rectangulaires	7-11
- spéciaux	7-12

Protections	13-1 ... 13-6
- étiquettes autocollantes	13-2
- étiquettes électrostatiques	13-4
- films de protection	13-6
- rubans adhésifs en polyimide	13-6

Quartz pour circuits électroniques	8-8
---	------------

Rallongeurs de tiges	8-2 ... 8-4
-----------------------------	--------------------

Tiges de remontoir	8-5 ... 8-7
---------------------------	--------------------

 Tubes	6-1 ... 6-8
- pour boîtes et couronnes	6-2
- pour couronnes à vis et joints	6-5

Verres	11-1 ... 11-17
- divers	11-16
- joints pour verres	11-15
- minéraux	11-3
- plaques minérales	11-10
- plexiglas	11-12
- ronds avec bague de tension	11-14
- saphir	11-9

Vis	9-3 ... 9-6
- pour fonds de boîtes	9-3
- pour lunettes	9-6

→ Voir index numérique pages 17-9 ... 17-15

Batteries	16-1 ... 16-10
- batteries	16-2
- battery adapters	16-5
- battery clamps	16-10
- capacitors	16-6

Clasps for bracelets	10-1 ... 10-9
-----------------------------	----------------------

Clock parts	15-1 ... 15-15
- conical pins	15-4
- hand-collets	15-5
- keys for clocks and pocket watches	15-2
- numerals	15-13
- suspensions	15-6
- washers	15-5

Crowns	5-1 ... 5-71
---------------	---------------------

- brand	5-66
- dustproof	5-8
- dustproof domed	5-12
- japanese	5-39
- pocket watches	5-47
- regular	5-4
- screw-on	5-51
- waterproof	5-14
- waterproof domed	5-34
- working	5-71

Crystals	11-1 ... 11-17
-----------------	-----------------------

- gaskets for crystals	11-15
- mineral	11-3
- mineral sheets	11-10
- miscellaneous	11-16
- plexiglas	11-12
- round with tension ring	11-14
- sapphire	11-9

Dial feet	9-2
------------------	------------

Gaskets	1-1 ... 1-21
----------------	---------------------

- flat	1-2
- for crystals	11-15
- mini O-Ring	1-13
- miscellaneous	1-15
- red	1-20
- round	1-6

Hands	4-1 ... 4-17
--------------	---------------------

- for old watches	4-14
-------------------	------

- for watches	4-2
---------------	-----

Pins	3-1 ... 3-22
-------------	---------------------

- conical	3-22
- knurled	3-12
- open-end	3-2
- with notch	3-20

Protections	13-1 ... 13-6
--------------------	----------------------

- adhesive ribbons in polyimide	13-6
- electrostatic labels	13-4
- protective films	13-6
- self-adhesive labels	13-2

Pushers	7-1 ... 7-13
----------------	---------------------

- press-in	7-2
- rectangular	7-11
- screw-on	7-10
- special	7-12

Quartz for electronic circuits	8-8
---------------------------------------	------------

Screws	9-3 ... 9-6
---------------	--------------------

- for case backs	9-3
- for spectacles	9-6

Spring bars	2-1 ... 2-64
--------------------	---------------------

- female	2-44
- flanged	2-4
- for clasps	2-35
- press-in	2-46
- regular	2-29
- screw-on	2-55
- special	2-41
- universal	2-26

Stem extenders	8-2 ... 8-4
-----------------------	--------------------

Tubes	6-1 ... 6-8
--------------	--------------------

- for cases and crowns	6-2
- for screw-on crowns and gaskets	6-5

Watch assembly kits	14-1 ... 14-10
----------------------------	-----------------------

Winding stems	8-5 ... 8-7
----------------------	--------------------

→ See numerical index pages 17-9 ... 17-15

Aufzugswellen 8-5 ... 8-7

Aufzugswellen-Verlängerungen 8-2 ... 8-4

Batterien 16-1 ... 16-10

- Akkumulatoren	16-6
- Batterieadapter	16-5
- Batteriehaltefedern	16-10
- Batterien	16-2

Dichtungen 1-1 ... 1-21

- flach	1-2
- für Gläsern	11-15
- mini O-Ring	1-13
- rote	1-20
- rund	1-6
- unterschiedliche	1-15

Drücker 7-1 ... 7-13

- rechteckiger	7-11
- spezielle	7-12
- zum einpressen	7-2
- zum schrauben	7-10

Federstege 2-1 ... 2-64

- doppel-Ansatz	2-4
- druck-	2-46
- einfache	2-29
- für Schliessen	2-35
- schraub-	2-55
- spezielle	2-41
- universelle	2-26
- weibliche	2-44

Gläsern 11-1 ... 11-17

- aus Plexiglas	11-12
- Dichtungen für Gläsern	11-15
- Mineral-	11-3
- Mineralplatten	11-10
- runde mit Spannungsring	11-14
- Saphir-	11-9
- unterschiedliche	11-16

Kits für Uhrenmontage 14-1 ... 14-10

Kronen 5-1 ... 5-71

- Arbeits-	5-71
- einfache	5-4
- für Taschenuhren	5-47

- Japanische	5-39
- Marken-	5-66
- Schraub-	5-51
- staubgeschützte	5-8
- staubgeschützte Halbkugel	5-12
- wasserdichte	5-14
- wasserdichte Halbkugel	5-34

Pendeluhr 15-1 ... 15-15

- Federn	15-6
- konische Stifte	15-4
- Scheibchen	15-5
- Schlüssel für Pendel- und Taschenuhren	15-2
- Ziffern	15-13

Quarz für E-Blöcke 8-8

Röhre 6-1 ... 6-8

- für Gehäuse und Kronen	6-2
- für Schraubkronen und Dichtungen	6-5

Schliessen für Armbänder 10-1 ... 10-9

Schrauben 9-3 ... 9-6

- für Brillen	9-3
- für Gehäuseböden	9-6

Schutz 13-1 ... 13-6

- elektrostatische Etiketten	13-4
- Klebebänder aus Polyimid	13-6
- Schutzfilme	13-6
- selbstklebende Etiketten	13-2

Stiften 3-1 ... 3-22

- gerändelten	3-12
- konische	3-22
- mit Kerbe	3-20
- splinte	3-2

Zeiger 4-1 ... 4-17

- für alte Uhren	4-14
- für Uhren	4-2

Zifferblattfüsse 9-2

→ Siehe numerisches Inhaltsverzeichnis 17-9 ... 17-15

Agujas 4-1 ... 4-17

- para relojes	4-2
- para relojes antiguos	4-14

Alargadores de tijas 8-2 ... 8-4

Baterías 16-1 ... 16-10

- acumuladores	16-6
- adaptadores de batería	16-5
- bridas de fijación de batería	16-10
- baterías	16-2

Cierres para pulseras 10-1 ... 10-9

Coronas 5-1 ... 5-71

- antipolvo	5-8
- antipolvo media-bola	5-12
- de marca	5-66
- de rosca	5-51
- de trabajo	5-71
- herméticas	5-14
- herméticas media bola	5-34
- japonesas	5-39
- para relojes de bolsillo	5-47
- sencillas	5-4

Cristales 11-1 ... 11-17

- diversos	11-16
- juntas para cristales	11-15
- minerales	11-3
- placas minerales	11-10
- plexiglás	11-12
- redondas con aro de tensión	11-14
- zafiro	11-9

Cuarzo para circuitos electrónicos 8-8

Grupillas 3-1 ... 3-22

- con muesca	3-20
- cónicas	3-22
- hendidas	3-2
- moleteadas	3-12

Juntas 1-1 ... 1-21

- diversas	1-15
- mini O-Ring	1-13
- para cristales	11-15
- planas	1-2
- redondas	1-6

- rojas	1-20
---------	------

Kits para el montaje de relojes 14-1 ... 14-10

Pasadores 2-1 ... 2-64

- de presión	2-46
- de rosca	2-55
- de seguridad	2-4
- especiales	2-41
- hembra	2-44
- para cierres	2-35
- sencillos	2-29
- universales	2-26

Pendulería 15-1 ... 15-15

- arandelas	15-5
- gotas	15-5
- grupillas cónicas	15-4
- llaves para péndulos y relojes de bolsillo	15-2
- números	15-13
- suspensiones	15-6

Pies de esfera 9-2

Protecciones 13-1 ... 13-6

- cintas adhesivas en poliimida	13-6
- etiquetas autoadhesivas	13-2
- etiquetas electrostáticas	13-4
- films de protección	13-6

Pulsadores 7-1 ... 7-13

- a presión	7-2
- de rosca	7-10
- especiales	7-12
- rectangulares	7-11

Tijas de remontar 8-5 ... 8-7

Tornillos 9-3 ... 9-6

- para fondos de cajas	9-3
- para gafas	9-6

Tubos 6-1 ... 6-8

- para cajas y coronas	6-2
- para coronas de rosca y juntas	6-5

→ Ver índice numérico páginas 17-9 ... 17-15

Alberi di carica 8-5 ... 8-7**Anse** 2-1 ... 2-64

- a pressione	2-46
- a vite	2-55
- di sicurezza	2-4
- femmina	2-44
- per chiusure	2-35
- semplici	2-29
- speciali	2-41
- universali	2-26

Batterie 16-1 ... 16-10

- accumulatori	16-6
- adattatori per batterie	16-5
- batterie	16-2
- bride di fissaggio della batteria	16-10

Chiusure per cinturini 10-1 ... 10-9**Copiglie** 3-1 ... 3-22

- con tacca	3-20
- coniche	3-22
- spaccate	3-2
- ziggrinate	3-12

Corone 5-1 ... 5-71

- a vite	5-51
- antipolvere	5-8
- antipolvere demiboule	5-12
- di lavoro	5-71
- di marca	5-66
- giapponesi	5-39
- impermeabili	5-14
- impermeabili demiboule	5-34
- per orologi da tasca	5-47
- semplici	5-4

Guarnizioni 1-1 ... 1-21

- mini O-Ring	1-13
- per vetri	11-15
- piatte	1-2
- rosse	1-20
- tonde	1-6
- varie	1-15

Kits per l'assemblaggio di orologi 14-1 ... 14-10**Lancette** 4-1 ... 4-17

- per orologi	4-2
- per orologi antichi	4-14

Pendoleria 15-1 ... 15-15

- chiavi per pendole e orologi da tasca	15-2
- copiglie coniche	15-4
- gocce	15-5
- numeri	15-13
- rondelle	15-5
- sospensioni	15-6

Piedini di quadrante 9-2**Prolunghe per alberi di carica** 8-2 ... 8-4**Protezioni** 13-1 ... 13-6

- adesivi elettrostatici	13-4
- etichette autoadesive	13-2
- nastri adesivi in poliimmide	13-6
- pellicola di protezione	13-6

Pulsanti 7-1 ... 7-13

- a pressione	7-2
- a vite	7-10
- rettangolari	7-11
- speciali	7-12

Quarzo per circuiti elettronici 8-8**Tubi** 6-1 ... 6-8

- per casse e corone	6-2
- per corone a vite e guarnizioni	6-5

Vetri 11-1 ... 11-17

- diversi	11-16
- guarnizioni per vetri	11-15
- lastrine minerali	11-10
- minerali	11-3
- plexiglas	11-12
- rotondi con ghiera di tensione	11-14
- zaffiro	11-9

Viti 9-3 ... 9-6

- per fondo cassa	9-3
- per occhiali	9-6

→ Vedere indice numerico pagine 17-9 ... 17-15

Acrescentadores de tiges 8-2 ... 8-4**Botões** 7-1 ... 7-13

- de pressão	7-2
- de rosca	7-10
- especiais	7-12
- rectangulares	7-11

Cavilhas 3-1 ... 3-22

- com entalhe	3-20
- cônicas	3-22
- rachadas	3-2
- serrilhadas	3-12

Coroas 5-1 ... 5-71

- anti-poeira	5-8
- anti-poeira meia bola	5-12
- de marca	5-66
- de rosca	5-51
- de trabalho	5-71
- estanques	5-14
- estanques meia bola	5-34
- japonesas	5-39
- para relógios de bolso	5-47
- simples	5-4

Fechos para braceletes 10-1 ... 10-9**Juntas** 1-1 ... 1-21

- diversas	1-15
- mini O-Ring	1-13
- para vidros	11-15
- planas	1-2
- redondas	1-6
- vermelhas	1-20

Kits para a montagem de relógios 14-1 ... 14-10**Parafusos** 9-3 ... 9-6

- para fundos de caixas	9-3
- para óculos	9-6

Pêndularia 15-1 ... 15-15

- cavilhas cônicas	15-4
- chaves para pêndulos e relógios de bolso	15-2
- gotas	15-5
- números	15-13
- rodela	15-5
- suspensões	15-6

Pés de mostrador 9-2**Pilhas** 16-1 ... 16-10

- acumuladores	16-6
- adaptadores de pilha	16-5
- bridas de fixação de pilha	16-10
- pilhas	16-2

Pinos 2-1 ... 2-64

- de pressão	2-46
- de rosca	2-55
- de segurança	2-4
- especiais	2-41
- fêmeos	2-44
- para fechos	2-35
- simples	2-29
- universais	2-26

Ponteiros 4-1 ... 4-17

- para relógios	4-2
- para relógios antigos	4-14

Protecções 13-1 ... 13-6

- etiquetas autocolantes	13-2
- etiquetas electrostáticas	13-4
- filmes de protecção	13-6
- fitas adesivas em poliimida	13-6

Quartzo para circuitos electrónicos 8-8**Tiges de dar corda** 8-5 ... 8-7**Tubos** 6-1 ... 6-8

- para caixas e coroas	6-2
- para coroas de rosca e juntas	6-5

Vidros 11-1 ... 11-17

- diversos	11-16
- juntas para vidros	11-15
- minerais	11-3
- placas minerais	11-10
- plexiglas	11-12
- redondos com aro de tensão	11-14
- safira	11-9

→ Ver índice numérico páginas 17-9 ... 17-15



Le catalogue HOROTEC® WATCH PARTS SERVICE est édité à La Chaux-de-Fonds, Suisse, Copyright © 2018.
Reproduction, modification et diffusion partielles ou totales sont interdites sans l'autorisation écrite de l'éditeur.
Tous droits réservés.

*The HOROTEC® WATCH PARTS SERVICE catalogue is published in La Chaux-de-Fonds, Switzerland, Copyright © 2018.
Reproduction, modification and distribution in part or whole is forbidden without written permission from the Editor.
All rights reserved.*

Der HOROTEC® WATCH PARTS SERVICE Katalog wird an La Chaux-de-Fonds veröffentlicht, Copyright © 2018.
Nachdruck, auch auszugsweise, ist nur mit schriftlicher Genehmigung gestattet.
Alle Rechte vorbehalten.

*El catálogo HOROTEC® WATCH PARTS SERVICE es publicado en La Chaux-de-Fonds, Suiza, Copyright © 2018.
Reproducción, modificación y difusión parciales o totales son prohibidas sin la autorización escrita del editor.
Todos los derechos reservados.*

Il catalogo HOROTEC® WATCH PARTS SERVICE è pubblicato a La Chaux-de-Fonds, Svizzera, Copyright © 2018.
Riproduzione, modificazione e diffusione parziali o totali sono vietate senza l'autorizzazione scritta dell'editore.
Tutti i diritti riservati.

*O catálogo HOROTEC® WATCH PARTS SERVICE é editado em La Chaux-de-Fonds, Suíça, Copyright © 2018.
Reprodução, modificação e difusão parciais ou totais são proibidas sem autorização escrita do editor.
Todos os direitos reservados.*

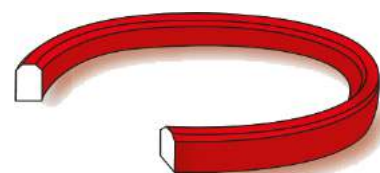

JOINTS PLATS ■ FLAT GASKETS ■ FLACHDICHTUNGEN
JUNTAS PLANAS ■ GUARNIZIONI PIATTE

01 - 2

JOINTS RONDS ■ ROUND GASKETS ■ RUNDDICHTUNGEN
JUNTAS REDONDAS ■ GUARNIZIONI TONDE

01 - 4

JOINTS MINI O-RING ■ MINI O-RING GASKETS ■ MINI O-RING DICHTUNGEN
JUNTAS MINI O-RING ■ GUARNIZIONI MINI O-RING

01 - 8

JOINTS DIVERS ■ MISCELLANEOUS GASKETS ■ UNTERSCHIEDLICHE DICHTUNGEN
JUNTAS DIVERSAS ■ GUARNIZIONI DIVERSE

01 - 9

JOINTS ROUGES ■ RED GASKETS ■ ROTE DICHTUNGEN
JUNTAS ROJAS ■ GUARNIZIONI ROSSE

01 - 10

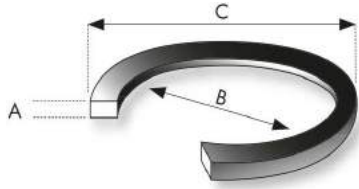

Joint plat ; sachet de 2 pièces.
 Flat gasket ; bag of 2 pieces.
 Flachdichtung ; Beutel von 2 Stück.

Junta plana ; bolsita de 2 piezas.
 Guarnizione piatta ; bustina da 2 pezzi.

2 pièces / pieces / Stück / piezas / pezzi

MSA	A mm	B Ø mm	C Ø mm
43.050-101	0.50	15.40	16.80
43.050-102	0.50	15.70	16.90
43.050-103	0.60	16.00	17.20
43.050-104	0.50	17.00	18.20
43.050-105	0.50	17.80	18.70
43.050-106	0.50	17.80	19.50
43.050-107	0.50	18.20	19.70
43.050-108	0.50	19.20	20.30
43.050-109	0.50	19.50	20.60
43.050-110	0.50	19.80	20.80
43.050-111	0.50	19.80	21.30
43.050-112	0.50	20.00	21.60
43.050-113	0.50	20.70	21.90
43.050-114	0.50	21.00	22.20
43.050-115	0.50	21.00	22.50
43.050-116	0.50	21.90	23.50
43.050-118	0.50	22.00	24.00
43.050-120	0.50	22.10	24.90
43.050-117	0.50	22.30	23.70
43.050-119	0.50	22.80	24.50

MSA	A mm	B Ø mm	C Ø mm
43.050-121	0.50	23.40	25.20
43.050-122	0.50	24.00	25.20
43.050-123	0.50	24.00	25.50
43.050-124	0.50	25.10	26.50
43.050-125	0.50	26.00	27.40
43.050-126	0.50	26.10	27.70
43.050-127	0.50	26.50	28.20
43.050-128	0.50	26.50	28.50
43.050-129	0.50	26.90	28.60
43.050-130	0.50	27.25	28.75
43.050-131	0.50	27.60	29.00
43.050-133	0.50	27.80	30.00
43.050-132	0.50	28.00	29.50
43.050-135	0.50	28.50	30.40
43.050-134	0.50	28.80	30.20
43.050-136	0.50	29.00	30.50
43.050-138	0.50	29.30	31.30
43.050-137	0.50	29.50	31.00
43.050-139	0.50	30.00	31.50
43.050-140	0.50	30.00	32.00

MSA	A mm	B Ø mm	C Ø mm
43.050-142	0.50	30.00	32.50
43.050-148	0.50	30.00	33.70
43.050-141	0.50	30.50	32.30
43.050-143	0.50	31.00	33.00
43.050-145	0.50	31.40	33.20
43.050-146	0.50	31.50	33.30
43.050-149	0.50	31.50	33.80
43.050-144	0.50	31.60	33.00
43.050-153	0.50	31.80	34.20
43.050-150	0.50	32.00	33.80
43.050-156	0.50	32.00	35.00
43.050-151	0.50	32.20	34.00
43.050-152	0.50	32.40	34.00
43.050-155	0.50	32.50	34.30
43.050-154	0.50	32.80	34.20
43.050-157	0.50	33.20	35.20
43.050-158	0.50	33.50	35.50
43.050-159	0.50	34.10	35.80
43.050-160	0.50	35.00	37.00

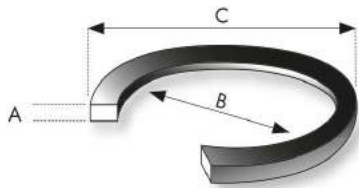

Joint plat ; sachet de 100 pièces.
 Flat gasket ; bag of 100 pieces.
 Flachdichtung ; Beutel von 100 Stück.

Junta plana ; bolsita de 100 piezas.
 Guarnizione piatta ; bustina da 100 pezzi.

100 pièces / pieces / Stück / piezas / pezzi

MSA	A mm	B Ø mm	C Ø mm
43.002-101	0.50	15.40	16.80
43.002-102	0.50	15.70	16.90
43.002-103	0.60	16.00	17.20
43.002-104	0.50	17.00	18.20
43.002-105	0.50	17.80	18.70
43.002-106	0.50	17.80	19.50
43.002-107	0.50	18.20	19.70
43.002-108	0.50	19.20	20.30
43.002-109	0.50	19.50	20.60
43.002-110	0.50	19.80	20.80
43.002-111	0.50	19.80	21.30
43.002-112	0.50	20.00	21.60
43.002-113	0.50	20.70	21.90
43.002-114	0.50	21.00	22.20
43.002-116	0.50	21.90	23.50
43.002-118	0.50	22.00	24.00
43.002-120	0.50	22.10	24.90
43.002-117	0.50	22.30	23.70
43.002-119	0.50	22.80	24.50
43.002-121	0.50	23.40	25.20

MSA	A mm	B Ø mm	C Ø mm
43.002-122	0.50	24.00	25.20
43.002-123	0.50	24.00	25.50
43.002-124	0.50	25.10	26.50
43.002-125	0.50	26.00	27.40
43.002-126	0.50	26.10	27.70
43.002-127	0.50	26.50	28.20
43.002-128	0.50	26.50	28.50
43.002-129	0.50	26.90	28.60
43.002-130	0.50	27.25	28.75
43.002-131	0.50	27.60	29.00
43.002-133	0.50	27.80	30.00
43.002-132	0.50	28.00	29.50
43.002-135	0.50	28.50	30.40
43.002-134	0.50	28.80	30.20
43.002-136	0.50	29.00	30.50
43.002-161	0.50	29.00	30.70
43.002-138	0.50	29.30	31.30
43.002-137	0.50	29.50	31.00
43.002-139	0.50	30.00	31.50
43.002-140	0.50	30.00	32.00

MSA	A mm	B Ø mm	C Ø mm
43.002-142	0.50	30.00	32.50
43.002-148	0.50	30.00	33.70
43.002-141	0.50	30.50	32.30
43.002-143	0.50	31.00	33.00
43.002-145	0.50	31.40	33.20
43.002-146	0.50	31.50	33.30
43.002-147	0.50	31.50	33.50
43.002-149	0.50	31.50	33.80
43.002-144	0.50	31.60	33.00
43.002-153	0.50	31.80	34.20
43.002-150	0.50	32.00	33.80
43.002-156	0.50	32.00	35.00
43.002-151	0.50	32.20	34.00
43.002-152	0.50	32.40	34.00
43.002-155	0.50	32.50	34.30
43.002-154	0.50	32.80	34.20
43.002-157	0.50	33.20	35.20
43.002-158	0.50	33.50	35.50
43.002-159	0.50	34.10	35.80
43.002-160	0.50	35.00	37.00

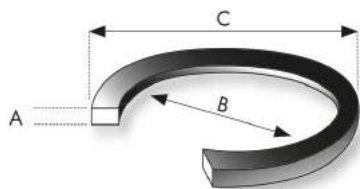

2 pièces / pieces / Stück / piezas / pezzi

MSA	N° / No.	A mm	B Ø mm	C Ø mm
43.050-2920	FH-2920-B01	0.50	29.00	30.70
43.050-2980	FH-2980-B01	0.50	29.70	31.50

Joint plat type Seiko ; sachet de 2 pièces.
Flat gasket Seiko type ; bag of 2 pieces.
Flachdichtung Seiko Typ ; Beutel von 2 Stück.

Junta plana tipo Seiko ; bolsita de 2 piezas.
Guarnizione piatta tipo Seiko ; bustina da 2 pezzi.



50 pièces / pieces / Stück / piezas / pezzi

MSA	Qté. / Qty.	Kg
43.030	50x	0.004

Assortiment de joints plats.
Assortment of flat gaskets.
Sortiment von Flachdichtungen.

Surtido de juntas planas.
Assortimento di guarnizioni piatte.



100 pièces / pieces / Stück / piezas / pezzi

MSA	Qté. / Qty.	Kg
43.031	100x	0.006

Assortiment de joints plats.
Assortment of flat gaskets.
Sortiment von Flachdichtungen.

Surtido de juntas planas.
Assortimento di guarnizioni piatte.



Contenu / Contents / Inhalt / Contenido / Contenuto : 59 modèles - models - Modelle - modelos - modelli
2x MSA43.050-101 -102 -103 -104 -105 -106 -107 -108 -109 -110 -111 -112 -113 -114 -115 -116 -117 -118 -119 -120 -121 -122
-123 -124 -125 -126 -127 -128 -129 -130 -131 -132 -133 -134 -135 -136 -137 -138 -139 -140 -141 -142 -143 -144 -145 -146 -148
-149 -150 -151 -152 -153 -154 -155 -156 -157 -158 -159 -160

MSA	Qté. / Qty.	Kg
43.521	236x	0.252

Assortiment de joints plats ; boîte en bois avec 118 sachets.
Assortment of flat gaskets ; wooden box with 118 bags.
Sortiment von Flachdichtungen ; Holzkasten mit 118 Beutel.

Surtido de juntas planas ; caja de madera con 118 bolsitas.
Assortimento di guarnizioni piatte ; scatola di legno con 118 bustine.

2 joints/sachet / 2 gaskets/bag / 2 Dichtungen/Beutel
2 juntas/bolsita / 2 guarnizioni/bustina

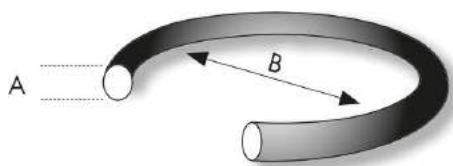

Joint rond; sachet de 2 pièces.
 Round gasket ; bag of 2 pieces.
 Rundsichtung ; Beutel von 2 Stück.

Junta redonda ; bolsita de 2 piezas.
 Guarnizione tonda ; bustina da 2 pezzi.

2 pièces / pieces / Stück / piezas / pezzi

MSA	A Ø mm	B Ø mm	MSA	A Ø mm	B Ø mm	MSA	A Ø mm	B Ø mm
43.041-446	0.30	30.30	43.041-454	0.50	32.40	43.040-049	0.80	32.15
43.041-404	0.35	16.50	43.041-455	0.50	33.00	43.040-051	0.80	32.40
43.041-410	0.35	18.00	43.040-001	0.60	15.90	43.040-078	0.80	33.00
43.041-417	0.35	20.50	43.040-002	0.60	16.50	43.040-079	0.80	33.50
43.041-433	0.35	26.50	43.040-003	0.60	17.00	43.040-080	0.80	34.00
43.041-401	0.40	15.00	43.040-006	0.60	18.30	43.040-081	0.80	34.50
43.041-402	0.40	15.50	43.040-008	0.60	19.40	43.041-458	0.80	35.00
43.041-403	0.40	15.80	43.040-011	0.60	20.00	43.040-082	0.80	35.50
43.041-406	0.40	17.00	43.041-423	0.60	22.10	43.040-083	0.80	36.00
43.041-409	0.40	17.70	43.040-063	0.60	24.00	43.040-084	0.80	36.50
43.041-412	0.40	19.20	43.040-020	0.60	26.40	43.040-085	0.80	37.00
43.041-413	0.40	19.60	43.040-068	0.60	27.00	43.040-086	0.80	37.50
43.041-414	0.40	20.00	43.041-436	0.60	27.50	43.040-087	0.80	38.00
43.041-416	0.40	20.40	43.040-024	0.60	27.70	43.040-088	0.80	38.50
43.041-418	0.40	21.00	43.040-067	0.60	28.00	43.040-089	0.80	39.50
43.041-421	0.40	21.80	43.040-065	0.60	28.50	43.040-090	0.80	41.50
43.041-424	0.40	23.00	43.040-029	0.60	28.90	43.040-091	0.80	43.00
43.041-463	0.40	23.50	43.040-035	0.60	30.00	43.040-092	0.80	44.00
43.041-461	0.40	24.00	43.041-447	0.60	30.50	43.040-093	0.80	45.00
43.041-462	0.40	26.00	43.041-450	0.60	31.20	43.040-023	0.85	26.90
43.041-438	0.40	28.00	43.041-456	0.60	33.50	43.040-041	0.85	30.80
43.041-441	0.40	28.90	43.041-457	0.60	34.00	43.040-012	0.90	20.60
43.041-451	0.40	31.50	43.041-459	0.60	36.00	43.040-040	0.90	30.70
43.041-407	0.45	17.30	43.041-460	0.60	38.30	43.040-055	0.90	32.20
43.041-405	0.50	16.50	43.040-069	0.60	38.70	43.040-057	0.90	33.90
43.040-004	0.50	17.60	43.040-070	0.60	39.00	43.040-016	1.00	22.00
43.040-005	0.50	18.00	43.040-071	0.60	39.50	43.040-018	1.00	23.00
43.041-411	0.50	18.50	43.040-072	0.60	40.50	43.040-022	1.00	26.25
43.040-007	0.50	19.20	43.040-073	0.60	41.00	43.040-026	1.00	27.50
43.040-009	0.50	19.80	43.040-074	0.60	42.50	43.040-028	1.00	28.00
43.041-415	0.50	20.00	43.040-075	0.60	43.00	43.040-030	1.00	28.25
43.041-419	0.50	21.00	43.040-076	0.60	45.80	43.040-032	1.00	28.40
43.041-420	0.50	21.50	43.040-077	0.60	47.50	43.040-034	1.00	29.00
43.041-422	0.50	22.00	43.040-100	0.65	26.00	43.040-036	1.00	29.30
43.041-425	0.50	23.00	43.040-014	0.70	22.10	43.040-038	1.00	29.75
43.041-427	0.50	24.00	43.040-025	0.70	27.60	43.040-061	1.00	30.00
43.041-428	0.50	24.60	43.040-046	0.70	31.80	43.040-043	1.00	30.75
43.041-429	0.50	25.00	43.040-033	0.75	29.30	43.040-044	1.00	31.00
43.041-431	0.50	25.70	43.040-050	0.75	32.50	43.040-066	1.00	31.50
43.041-432	0.50	26.00	43.040-010	0.80	19.40	43.040-052	1.00	32.00
43.041-434	0.50	26.80	43.040-013	0.80	21.00	43.040-101	1.00	32.40
43.041-435	0.50	27.20	43.040-015	0.80	22.10	43.040-053	1.00	32.50
43.041-437	0.50	27.60	43.040-017	0.80	22.90	43.040-062	1.00	33.00
43.041-439	0.50	28.30	43.040-019	0.80	25.20	43.040-058	1.00	33.75
43.041-440	0.50	28.50	43.040-064	0.80	26.00	43.040-060	1.00	35.30
43.041-442	0.50	29.00	43.040-027	0.80	28.00	43.040-094	1.00	36.00
43.041-443	0.50	29.30	43.040-031	0.80	28.70	43.040-095	1.00	39.00
43.041-444	0.50	29.60	43.040-037	0.80	30.00	43.040-096	1.00	41.50
43.041-445	0.50	29.80	43.040-039	0.80	30.50	43.040-097	1.00	43.00
43.041-449	0.50	31.00	43.040-042	0.80	31.00	43.040-098	1.00	46.00
43.041-464	0.50	31.50	43.040-045	0.80	31.50	43.040-099	1.00	50.00
43.041-452	0.50	31.80	43.040-047	0.80	31.80	43.040-054	1.05	32.40
43.041-453	0.50	32.00	43.040-048	0.80	32.00	43.040-059	1.50	34.00
						43.040-056	1.80	31.60

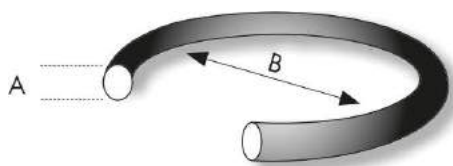

Joint rond ; sachet de 100 pièces.
Round gasket ; bag of 100 pieces.
Runddichtung ; Beutel von 100 Stück.

Junta redonda ; bolsita de 100 piezas.
Guarnizione tonda ; bustina da 100 pezzi.

100 pièces / pieces / Stück / piezas / pezzi

MSA	A Ø mm	B Ø mm	MSA	A Ø mm	B Ø mm	MSA	A Ø mm	B Ø mm
43.001-446	0.30	30.30	43.001-453	0.50	32.00	43.001-048	0.80	32.00
43.001-404	0.35	16.50	43.001-454	0.50	32.40	43.001-049	0.80	32.15
43.001-408	0.35	17.50	43.001-455	0.50	33.00	43.001-051	0.80	32.40
43.001-410	0.35	18.00	43.001-001	0.60	15.90	43.001-078	0.80	33.00
43.001-417	0.35	20.50	43.001-002	0.60	16.50	43.001-079	0.80	33.50
43.001-433	0.35	26.50	43.001-003	0.60	17.00	43.001-080	0.80	34.00
43.001-401	0.40	15.00	43.001-006	0.60	18.30	43.001-081	0.80	34.50
43.001-402	0.40	15.50	43.001-008	0.60	19.40	43.001-458	0.80	35.00
43.001-403	0.40	15.80	43.001-011	0.60	20.00	43.001-082	0.80	35.50
43.001-406	0.40	17.00	43.001-423	0.60	22.10	43.001-083	0.80	36.00
43.001-409	0.40	17.70	43.001-063	0.60	24.00	43.001-084	0.80	36.50
43.001-412	0.40	19.20	43.001-020	0.60	26.40	43.001-085	0.80	37.00
43.001-413	0.40	19.60	43.001-068	0.60	27.00	43.001-086	0.80	37.50
43.001-414	0.40	20.00	43.001-436	0.60	27.50	43.001-087	0.80	38.00
43.001-416	0.40	20.40	43.001-024	0.60	27.70	43.001-088	0.80	38.50
43.001-418	0.40	21.00	43.001-067	0.60	28.00	43.001-089	0.80	39.50
43.001-421	0.40	21.80	43.001-065	0.60	28.50	43.001-090	0.80	41.50
43.001-424	0.40	23.00	43.001-029	0.60	28.90	43.001-091	0.80	43.00
43.001-463	0.40	23.50	43.001-035	0.60	30.00	43.001-092	0.80	44.00
43.001-461	0.40	24.00	43.001-447	0.60	30.50	43.001-093	0.80	45.00
43.001-462	0.40	26.00	43.001-450	0.60	31.20	43.001-023	0.85	26.90
43.001-438	0.40	28.00	43.001-456	0.60	33.50	43.001-041	0.85	30.80
43.001-441	0.40	28.90	43.001-457	0.60	34.00	43.001-012	0.90	20.60
43.001-451	0.40	31.50	43.001-459	0.60	36.00	43.001-040	0.90	30.70
43.001-430	0.42	25.36	43.001-460	0.60	38.30	43.001-055	0.90	32.20
43.001-407	0.45	17.30	43.001-069	0.60	38.70	43.001-057	0.90	33.90
43.001-448	0.45	30.60	43.001-070	0.60	39.00	43.001-016	1.00	22.00
43.001-405	0.50	16.50	43.001-071	0.60	39.50	43.001-018	1.00	23.00
43.001-004	0.50	17.60	43.001-072	0.60	40.50	43.001-022	1.00	26.25
43.001-005	0.50	18.00	43.001-073	0.60	41.00	43.001-026	1.00	27.50
43.001-411	0.50	18.50	43.001-074	0.60	42.50	43.001-028	1.00	28.00
43.001-007	0.50	19.20	43.001-075	0.60	43.00	43.001-030	1.00	28.25
43.001-009	0.50	19.80	43.001-076	0.60	45.80	43.001-032	1.00	28.40
43.001-415	0.50	20.00	43.001-077	0.60	47.50	43.001-034	1.00	29.00
43.001-419	0.50	21.00	43.001-100	0.65	26.00	43.001-036	1.00	29.30
43.001-420	0.50	21.50	43.001-021	0.65	26.70	43.001-038	1.00	29.75
43.001-422	0.50	22.00	43.001-014	0.70	22.10	43.001-061	1.00	30.00
43.001-425	0.50	23.00	43.001-025	0.70	27.60	43.001-043	1.00	30.75
43.001-427	0.50	24.00	43.001-046	0.70	31.80	43.001-044	1.00	31.00
43.001-428	0.50	24.60	43.001-033	0.75	29.30	43.001-066	1.00	31.50
43.001-429	0.50	25.00	43.001-050	0.75	32.50	43.001-052	1.00	32.00
43.001-431	0.50	25.70	43.001-010	0.80	19.40	43.001-101	1.00	32.40
43.001-432	0.50	26.00	43.001-013	0.80	21.00	43.001-053	1.00	32.50
43.001-434	0.50	26.80	43.001-015	0.80	22.10	43.001-062	1.00	33.00
43.001-435	0.50	27.20	43.001-017	0.80	22.90	43.001-058	1.00	33.75
43.001-437	0.50	27.60	43.001-019	0.80	25.20	43.001-060	1.00	35.30
43.001-439	0.50	28.30	43.001-064	0.80	26.00	43.001-094	1.00	36.00
43.001-440	0.50	28.50	43.001-027	0.80	28.00	43.001-095	1.00	39.00
43.001-442	0.50	29.00	43.001-031	0.80	28.70	43.001-096	1.00	41.50
43.001-443	0.50	29.30	43.001-037	0.80	30.00	43.001-097	1.00	43.00
43.001-444	0.50	29.60	43.001-039	0.80	30.50	43.001-098	1.00	46.00
43.001-445	0.50	29.80	43.001-042	0.80	31.00	43.001-099	1.00	50.00
43.001-449	0.50	31.00	43.001-045	0.80	31.50	43.001-059	1.50	34.00
43.001-464	0.50	31.50	43.001-047	0.80	31.80	43.001-056	1.80	31.60



25 pièces / pieces / Stück / piezas / pezzi

MSA	Qté. / Qty.	Kg
43.043	25x	0.003

Assortiment de joints ronds, section Ø 0.30...0.45 mm.
 Assortment of round gaskets, section Ø 0.30...0.45 mm.
 Sortiment von Runddichtungen, Querschnitt Ø 0.30...0.45 mm.

Surtido de juntas redondas, sección Ø 0.30...0.45 mm.
 Assortimento di guarnizioni tonde, sezione Ø 0.30...0.45 mm.



50 pièces / pieces / Stück / piezas / pezzi

MSA	Qté. / Qty.	Kg
43.044	50x	0.004

Assortiment de joints ronds, section Ø 0.50 et 0.60 mm.
 Assortment of round gaskets, section Ø 0.50 and 0.60 mm.
 Sortiment von Runddichtungen, Querschnitt Ø 0.50 und 0.60 mm.

Surtido de juntas redondas, sección Ø 0.50 y 0.60 mm.
 Assortimento di guarnizioni tonde, sezione Ø 0.50 e 0.60 mm.



100 pièces / pieces / Stück / piezas / pezzi

MSA	Qté. / Qty.	Kg
43.045	100x	0.006

Assortiment de joints ronds, section Ø 0.65...1.80 mm.
 Assortment of round gaskets, section Ø 0.65...1.80 mm.
 Sortiment von Runddichtungen, Querschnitt Ø 0.65...1.80 mm.

Surtido de juntas redondas, sección Ø 0.65...1.80 mm.
 Assortimento di guarnizioni tonde, sezione Ø 0.65...1.80 mm.



MSA	Qté. / Qty.	Kg
43.511	316x	0.280

Assortiment de joints ronds ; boîte en bois avec 158 sachets.
Assortiment of round gaskets ; wooden box with 158 bags.
Sortiment von Runddichtungen ; Holzkasten mit 158 Beutel.

Surtido de juntas redondas ; caja de madera con 158 bolsitas.
Assortimento di guarnizioni tonde ; scatola di legno con 158 bustine.

2 joints/sachet / 2 gaskets/bag / 2 Dichtungen/Beutel
2 juntas/bolsita / 2 guarnizioni/bustina

Contenu / Contents / Inhalt / Contenido / Contenuto : 79 modèles - models - Modelle - modelos - modelli

2x MSA43.040-001 -002 -003 -004 -005 -006 -007 -008 -009 -010 -011 -012 -013 -014 -015 -016 -017 -018 -019 -020 -022 -023
-024 -025 -026 -027 -028 -029 -030 -031 -032 -033 -034 -035 -036 -037 -038 -039 -040 -041 -042 -043 -044 -045 -046 -047 -048
-049 -050 -051 -052 -053 -055 -056 -057 -058 -059 -060 -061 -062 -063 -064 -065 -066 -067 -068 -069 -070 -071 -072 -073 -074
-075 -076 -077 -078 -079 -080 -081 -082 -083 -084 -085 -086 -087 -088 -089 -090 -091 -092 -093 -094 -095 -096 -097 -098 -099
-100 -101

2x MSA43.041-401 -402 -403 -404 -405 -406 -407 -409 -410 -411 -412 -413 -414 -415 -416 -417 -418 -419 -420 -421 -422 -423
-424 -425 -427 -428 -429 -431 -432 -433 -434 -435 -436 -437 -438 -439 -440 -441 -442 -443 -444 -445 -446 -447 -449 -450 -451
-453 -454 -455 -456 -457 -458 -459 -460 -461 -462 -463 -464



MSA	Qté. / Qty.	Kg
43.060	50x	0.003

Assortiment de joints ronds, pour trappes de piles.
Assortiment of round gaskets, for battery covers.
Sortiment von Runddichtungen, für Batteriedeckel.

Surtido de juntas redondas, para tapas de baterías.
Assortimento di guarnizioni tonde, per tappi delle batterie.

50 pièces / pieces / Stück / piezas / pezzi



MSA	Qté. / Qty.	Kg
43.070	50x	0.002

Assortiment de joints ronds, pour couronnes et poussoirs.
Assortiment of round gaskets, for crowns and pushers.
Sortiment von Runddichtungen, für Kronen und Drücker.

Surtido de juntas redondas, para coronas y pulsadores.
Assortimento di guarnizioni tonde, per corone e pulsanti.

50 pièces / pieces / Stück / piezas / pezzi

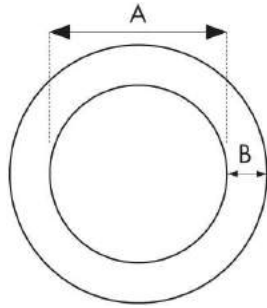

Joint mini O-Ring ; sachet de 100 pièces.
 Mini O-Ring gasket ; bag of 100 pieces.
 Mini O-Ring Dichtung ; Beutel von 100 Stück.

Junta mini O-Ring ; bolsita de 100 piezas.
 Guarnizione mini O-Ring ; bustina da 100 pezzi.

100 pièces / pieces / Stück / piezas / pezzi

MSA	A Ø mm	B Ø mm	MSA	A Ø mm	B Ø mm	MSA	A Ø mm	B Ø mm
43.080-001	0.50	0.30	43.080-041	0.85	0.40	43.080-025	1.50	0.50
43.080-002	0.50	0.40	43.080-036	0.90	0.40	43.080-026	1.50	0.75
43.080-003	0.50	0.50	43.080-035	0.95	0.50	43.080-037	1.60	0.40
43.080-004	0.60	0.35	43.080-015	1.00	0.40	43.080-027	1.60	0.50
43.080-005	0.60	0.40	43.080-016	1.00	0.50	43.080-028	1.60	0.70
43.080-006	0.60	0.50	43.080-017	1.00	0.60	43.080-039	1.70	0.50
43.080-007	0.60	0.55	43.080-018	1.20	0.40	43.080-040	1.70	0.60
43.080-008	0.60	0.65	43.080-019	1.20	0.60	43.080-029	1.80	0.40
43.080-009	0.70	0.40	43.080-020	1.30	0.40	43.080-030	1.80	0.60
43.080-010	0.70	0.50	43.080-021	1.30	0.50	43.080-031	1.80	0.80
43.080-011	0.70	0.60	43.080-022	1.40	0.40	43.080-032	2.00	0.50
43.080-012	0.80	0.40	43.080-023	1.40	0.50	43.080-033	2.00	0.60
43.080-013	0.80	0.50	43.080-024	1.40	0.60	43.080-034	2.50	0.65
43.080-014	0.80	0.60	43.080-042	1.50	0.70			



MSA	Qté. / Qty.	Kg
99.226	170x	0.035

Assortiment de joints mini O-Ring, Ø int. 0.50...1.00 mm.
 Assortment of mini O-Ring gaskets, Ø int. 0.50...1.00 mm.
 Sortiment von mini O-Ring Dichtungen, Ø inn. 0.50...1.00 mm.

Surtido de juntas mini O-Ring, Ø int. 0.50...1.00 mm.
 Assortimento di guarnizioni mini O-Ring, Ø int. 0.50...1.00 mm.

Contenu / Contents / Inhalt / Contenido / Contenuto : 17 modèles - models - Modelle - modelos - modelli
 10x MSA43.080-001 -002 -003 -004 -005 -006 -007 -008 -009 -010 -011 -012 -013 -014 -015 -016 -017



MSA	Qté. / Qty.	Kg
99.227	170x	0.035

Assortiment de joints mini O-Ring, Ø int. 1.20...2.50 mm.
 Assortment of mini O-Ring gaskets, Ø int. 1.20...2.50 mm.
 Sortiment von mini O-Ring Dichtungen, Ø inn. 1.20...2.50 mm.

Surtido de juntas mini O-Ring, Ø int. 1.20...2.50 mm.
 Assortimento di guarnizioni mini O-Ring, Ø int. 1.20...2.50 mm.

Contenu / Contents / Inhalt / Contenido / Contenuto : 17 modèles - models - Modelle - modelos - modelli
 10x MSA43.080-018 -019 -020 -021 -022 -023 -024 -025 -026 -027 -028 -029 -030 -031 -032 -033 -034

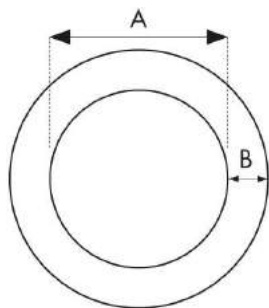

MSA	N° / No.	A Ø mm	B Ø mm	Kg
43.018	088NS0436	1.00	0.50	0.080
43.019	088NS0435	2.00	0.60	0.080

Joint O'Ring ; sachet de 100 pièces.
O'Ring gasket ; bag of 100 pieces.
O'Ring Dichtung ; Beutel von 100 Stück.

Junta O'Ring ; bolsita de 100 piezas.
Guarnizione O'Ring ; bustina da 100 pezzi.

100 pièces / pieces / Stück / piezas / pezzi

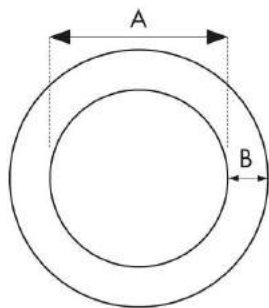

MSA	A Ø mm	B Ø mm	Kg
43.032	2.50	0.60	0.080

Joint O'Ring ; sachet de 1'000 pièces.
O'Ring gasket ; bag of 1'000 pieces.
O'Ring Dichtung ; Beutel von 1'000 Stück.

Junta O'Ring ; bolsita de 1'000 piezas.
Guarnizione O'Ring ; bustina da 1'000 pezzi.

1000 pièces / pieces / Stück / piezas / pezzi

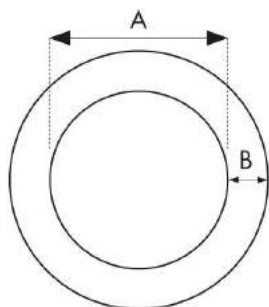

MSA	A Ø mm	B Ø mm	Kg
43.003	0.70	0.50	0.001

Joint rond pour tubes (intérieur) ; sachet de 10 pièces.
Round gasket for tubes (interior) ; bag of 10 pieces.
Runddichtung für Röhre (Innen) ; Beutel von 10 Stück.

Junta redonda para tubos (interior) ; bolsita de 10 piezas.
Guarnizione tonda per tubi (interno) ; bustina da 10 pezzi.

10 pièces / pieces / Stück / piezas / pezzi

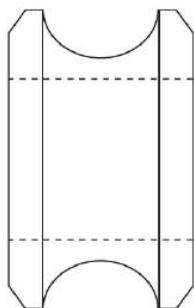

MSA	Ø int. / Ø ext. mm	Kg
43.006	1.50 x 2.80	0.001

Joint pour tube spécial MSA47.101 (voir page 6-4) ; sachet 10 pièces.
Gasket for special tube MSA47.101 (see page 6-4) ; bag 10 pieces.
Dichtung für spezieller Rohr MSA47.101 (siehe Seite 6-4) ; Beutel 10 Stück.

Junta para tubo especial MSA47.101 (ver página 6-4) ; bolsita 10 piezas.
Guarnizione per tubo speciale MSA47.101 (vedere pagina 6-4) ; bustina 10 pezzi.

*Voir chapitre TUBES / See TUBES chapter / Siehe RÖHRE Kapitel
Véase capítulo TUBOS / Vedere capitolo TUBI*

10 pièces / pieces / Stück / piezas / pezzi

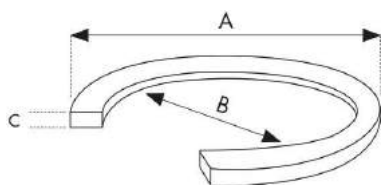

MSA	A Ø mm	B Ø mm	C mm
43.005	3.50	2.50	0.30
43.004	4.00	2.80	0.35

Joint plat pour couronnes à vis (intérieur) ; sachet de 10 pièces.
Flat gasket for screw-on crowns (interior) ; bag of 10 pieces.
Flachdichtung für Schraubkronen (Innen) ; Beutel von 10 Stück.

Junta plana para coronas de rosca (interior) ; bolsita de 10 piezas.
Guarnizione piatta per corone a vite (interno) ; bustina da 10 pezzi.

10 pièces / pieces / Stück / piezas / pezzi

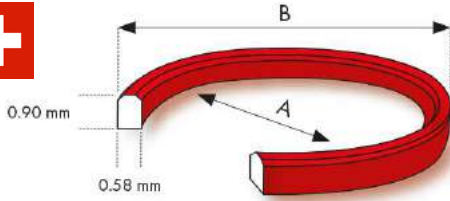

Joint rouge.
 Red gasket.
 Rote Dichtung.

Junta roja.
 Guarnizione rossa.

1 pièce / piece / Stück / pieza / pezzo

MSA	A Ø mm	B Ø mm	MSA	A Ø mm	B Ø mm	MSA	A Ø mm	B Ø mm
43.052-796	14.84	16.00	43.052-816	24.84	26.00	43.052-834	33.84	35.00
43.052-797	15.34	16.50	43.052-817	25.34	26.50	43.052-835	34.34	35.50
43.052-798	15.84	17.00	43.052-818	25.84	27.00	43.052-836	34.84	36.00
43.052-799	16.34	17.50	43.052-819	26.34	27.50	43.052-837	35.34	36.50
43.052-800	16.84	18.00	43.052-820	26.84	28.00	43.052-838	35.84	37.00
43.052-801	17.34	18.50	43.052-821	27.34	28.50	43.052-839	36.34	37.50
43.052-802	17.84	19.00	43.052-822	27.84	29.00	43.052-840	36.84	38.00
43.052-803	18.34	19.50	43.052-823	28.34	29.50	43.052-841	37.34	38.50
43.052-804	18.84	20.00	43.052-824	28.84	30.00	43.052-842	37.84	39.00
43.052-805	19.34	20.50	43.052-825	29.34	30.50	43.052-843	38.34	39.50
43.052-806	19.84	21.00	43.052-826	29.84	31.00	43.052-844	38.84	40.00
43.052-807	20.34	21.50	43.052-827	30.34	31.50	43.052-845	39.34	40.50
43.052-808	20.84	22.00	43.052-828	30.84	32.00	43.052-846	39.84	41.00
43.052-809	21.34	22.50	43.052-829	31.34	32.50	43.052-847	40.34	41.50
43.052-810	21.84	23.00	43.052-830	31.84	33.00	43.052-848	40.84	42.00
43.052-811	22.34	23.50	43.052-831	32.34	33.50	43.052-849	41.34	42.50
43.052-812	22.84	24.00	43.052-832	32.84	34.00	43.052-850	41.84	43.00
43.052-813	23.34	24.50	43.052-832A	33.05	34.00	43.052-851	42.34	43.50
43.052-814	23.84	25.00	43.052-833	33.34	34.50	43.052-852	42.84	44.00
43.052-815	24.34	25.50						



MSA	Qté. / Qty.	Kg
43.532	58x	0.215

Assortiment de joints rouges ; boîte en bois avec 58 sachets.
 Assortment of red gaskets ; wooden box with 58 bags.
 Sortiment von roten Dichtungen ; Holzkasten mit 58 Beutel.

Surtido de juntas rojas ; caja de madera con 58 bolsitas.
 Assortimento di guarnizioni rosse ; scatola di legno con 58 bustine.

1 joint/sachet / 1 gasket/bag / 1 Dichtung/Beutel
 1 junta/bolsita / 1 guarnizione/bustina

Contenu / Contents / Inhalt / Contenido - Contenuto : 58 modèles - models - Modelle - modelos - modelli
 1x MSA43.052-796 -797 -798 -799 -800 -801 -802 -803 -804 -805 -806 -807 -808 -809 -810 -811 -812 -813 -814 -815 -816 -817
 -818 -819 -820 -821 -822 -823 -824 -825 -826 -827 -828 -829 -830 -831 -832 -832-A -833 -834 -835 -836 -837 -838 -839 -840
 -841 -842 -843 -844 -845 -846 -847 -848 -849 -850 -851 -852



Voir le chapitre des VERRES pour les joints en Hytrel et Zytel.
 See the chapter of CRYSTALS for Hytrel and Zytel gaskets.
 Siehe das Kapitel der GLÄSER für die Dichtungen aus Hytrel und Zytel.

Ver el capítulo de los CRISTALES para las juntas en Hytrel y Zytel.
 Vedere il capitolo dei VETRI per le guarnizioni in Hytrel e Zytel.

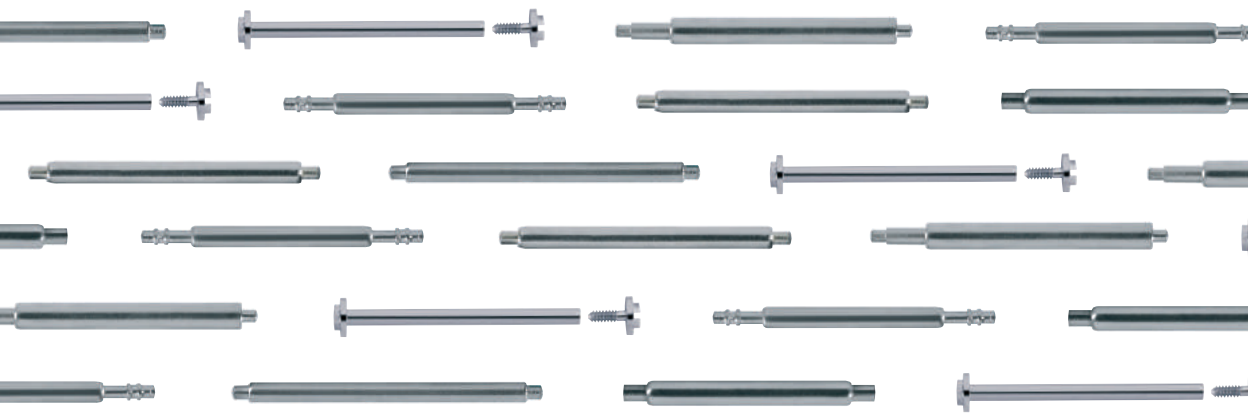

BARRETTES SPRING BARS FEDERSTEGE PASADORES ANSE PINOS

Barrettes de sécurité
Flanged spring bars
 Doppel-Ansatz Federstege
Pasadores de seguridad
 Anse di sicurezza
Pinos de segurança



4

Barrettes universelles
Universal spring bars
 Universelle Federstege
Pasadores universales
 Anse universali
Pinos universais



26

Barrettes simples
Regular spring bars
 Einfache Federstege
Pasadores sencillos
 Anse semplici
Pinos simples



29

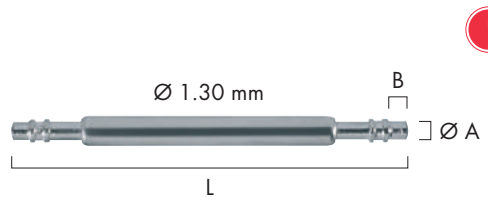

- L = distance des entre-cornes.
- L = distance between the lugs.
- L = Bügelabstand.
- L = distancia entre las asas.
- L = distanza tra le anse.
- L = distância entre as asas.

35



Barrettes pour fermoirs
Spring bars for clasps
 Federstege für Schliessen
Pasadores para cierres
 Anse per chiusure
Pinos para fechos

41



Barrettes spéciales
Special spring bars
 Spezielle Federstege
Pasadores especiales
 Anse speciali
Pinos especiais

44



Barrettes femelles
Female bars
 Weibliche Stege
Pasadores hembra
 Anse femmina
Pinos fêmeos



L = distance des entre-cornes.
 L = distance between the lugs.
 L = Bügelabstand.
 L = distancia entre las asas.
 L = distanza tra le anse.
 L = distância entre as asas.

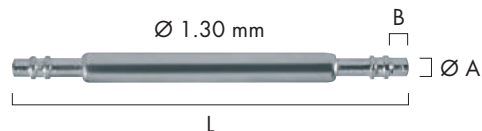

Barrettes à pression
Press-in bars
 Druckstege
Pasadores de presión
 Anse a pressione
Pinos de pressão



46

Barrettes à vis
Screw-on bars
 Schraubstege
Pasadores de rosca
 Anse a vite
Pinos de rosca



55

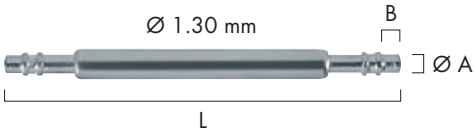

- L = distance des entre-cornes.
- L = distance between the lugs.
- L = Bügelabstand.
- L = distancia entre las asas.
- L = distanza tra le anse.
- L = distância entre as asas.

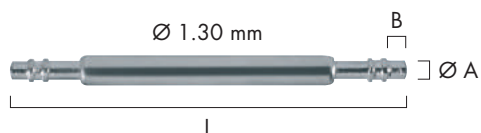

Barrette double sécurité; acier inoxydable.
 Double flanged spring bar; stainless steel.
 Doppel-Ansatz Federsteg; Edelstahl.
 Pasador doble seguridad; acero inoxidable.
 Ansa doppia sicurezza; acciaio inossidabile.
 Pino dupla segurança; aço inoxidável.

100
pcs

MSA	L mm	Ø A x B mm	Kg
46.300-06	6	0.80 x 0.80	0.005
46.300-07	7	0.80 x 0.80	0.005
46.300-08	8	0.80 x 0.80	0.006
46.300-09	9	0.80 x 0.80	0.006
46.300-10	10	0.80 x 0.80	0.007
46.300-11	11	0.80 x 0.80	0.008
46.300-12	12	0.80 x 0.80	0.008
46.300-13	13	0.80 x 0.80	0.009
46.300-14	14	0.80 x 0.80	0.010
46.300-15	15	0.80 x 0.80	0.010
46.300-16	16	0.80 x 0.80	0.010
46.300-17	17	0.80 x 0.80	0.012
46.300-18	18	0.80 x 0.80	0.012
46.300-19	19	0.80 x 0.80	0.012
46.300-20	20	0.80 x 0.80	0.013

10
pcs

MSA	L mm	Ø A x B mm	Kg
46.301-06	6	0.80 x 0.80	0.001
46.301-07	7	0.80 x 0.80	0.001
46.301-08	8	0.80 x 0.80	0.001
46.301-09	9	0.80 x 0.80	0.001
46.301-10	10	0.80 x 0.80	0.001
46.301-11	11	0.80 x 0.80	0.002
46.301-12	12	0.80 x 0.80	0.002
46.301-13	13	0.80 x 0.80	0.002
46.301-14	14	0.80 x 0.80	0.002
46.301-15	15	0.80 x 0.80	0.002
46.301-16	16	0.80 x 0.80	0.002
46.301-17	17	0.80 x 0.80	0.002
46.301-18	18	0.80 x 0.80	0.002
46.301-19	19	0.80 x 0.80	0.002
46.301-20	20	0.80 x 0.80	0.002



Ø 1.30 mm



Assortiment de barrettes double sécurité ; acier inoxydable.
 Assortment of double flanged spring bars ; stainless steel.
 Sortiment von Doppel-Ansatz Federstege ; Edelstahl.
 Surtido de pasadores doble seguridad ; acero inoxidable.
 Assortimento di anse doppia sicurezza ; acciaio inossidabile.
 Sortido de pinos dupla segurança ; aço inoxidável.

MSA	Qt.	Kg
99.027	100x	0.036

Contenu - Contents - Inhalt - Contenido - Contenuto - Conteúdo :
10 modèles - models - Modelle - modelos - modelli - modelos
10x MSA46.300-06 /-08 /-10 /-12 /-14 /-15 /-16 /-17 /-18 /-20



Ø 1.30 mm



Assortiment de barrettes double sécurité ; acier inoxydable.
 Assortment of double flanged spring bars ; stainless steel.
 Sortiment von Doppel-Ansatz Federstege ; Edelstahl.
 Surtido de pasadores doble seguridad ; acero inoxidable.
 Assortimento di anse doppia sicurezza ; acciaio inossidabile.
 Sortido de pinos dupla segurança ; aço inoxidável.

MSA	Qt.	Kg
99.058	1'000x	0.389

Contenu - Contents - Inhalt - Contenido
Contenuto - Conteúdo :
15 modèles - models - Modelle - modelos
modelli - modelos
1x MSA15.003
50x MSA46.300-06 /-07 /-08 /-09 /-10 /-11
/-13 /-15 /-17 /-19
100x MSA46.300-12 /-14 /-16 /-18 /-20

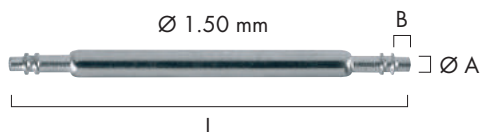

Barrette double sécurité ; acier inoxydable.
 Double flanged spring bar ; stainless steel.
 Doppel-Ansatz Federsteg ; Edelstahl.
 Pasador doble seguridad ; acero inoxidable.
 Ansa doppia sicurezza ; acciaio inossidabile.
 Pino dupla segurança ; aço inoxidável.

100
pcs

MSA	L mm	Ø A x B mm	Kg
46.310-07	7	0.80 x 0.80	0.007
46.310-08	8	0.80 x 0.80	0.007
46.310-09	9	0.80 x 0.80	0.008
46.310-10	10	0.80 x 0.80	0.009
46.310-11	11	0.80 x 0.80	0.009
46.310-12	12	0.80 x 0.80	0.010
46.310-13	13	0.80 x 0.80	0.012
46.310-14	14	0.80 x 0.80	0.012
46.310-15	15	0.80 x 0.80	0.013
46.310-16	16	0.80 x 0.80	0.013
46.310-17	17	0.80 x 0.80	0.014
46.310-18	18	0.80 x 0.80	0.015
46.310-19	19	0.80 x 0.80	0.015
46.310-20	20	0.80 x 0.80	0.016
46.310-21	21	0.80 x 0.80	0.016
46.310-22	22	0.80 x 0.80	0.017
46.310-23	23	0.80 x 0.80	0.018
46.310-24	24	0.80 x 0.80	0.018

10
pcs

MSA	L mm	Ø A x B mm	Kg
46.311-07	7	0.80 x 0.80	0.001
46.311-08	8	0.80 x 0.80	0.001
46.311-09	9	0.80 x 0.80	0.001
46.311-10	10	0.80 x 0.80	0.002
46.311-11	11	0.80 x 0.80	0.002
46.311-12	12	0.80 x 0.80	0.002
46.311-13	13	0.80 x 0.80	0.002
46.311-14	14	0.80 x 0.80	0.002
46.311-15	15	0.80 x 0.80	0.002
46.311-16	16	0.80 x 0.80	0.002
46.311-17	17	0.80 x 0.80	0.002
46.311-18	18	0.80 x 0.80	0.002
46.311-19	19	0.80 x 0.80	0.002
46.311-20	20	0.80 x 0.80	0.002
46.311-21	21	0.80 x 0.80	0.002
46.311-22	22	0.80 x 0.80	0.002
46.311-23	23	0.80 x 0.80	0.003
46.311-24	24	0.80 x 0.80	0.003

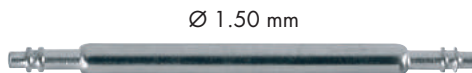
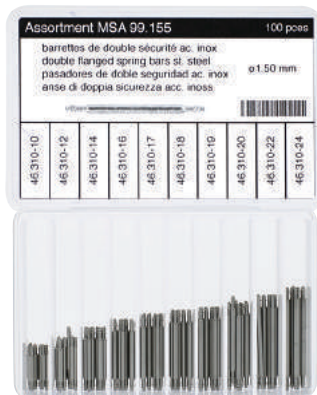

Assortiment de barrettes double sécurité ; acier inoxydable.
 Assortment of double flanged spring bars ; stainless steel.
 Sortiment von Doppel-Ansatz Federstege ; Edelstahl.
 Surtido de pasadores doble seguridad ; acero inoxidable.
 Assortimento di anse doppia sicurezza ; acciaio inossidabile.
 Sortido de pinos dupla segurança ; aço inoxidável.

MSA	Qt.	Kg
99.155	100x	0.041

Contenu - Contents - Inhalt - Contenido - Contenuto - Conteúdo :
10 modèles - models - Modelle - modelos - modelli - modelos
10x MSA46.310-10 /-12 /-14 /-16 /-17 /-18 /-19 /-20 /-22 /-24

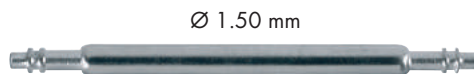
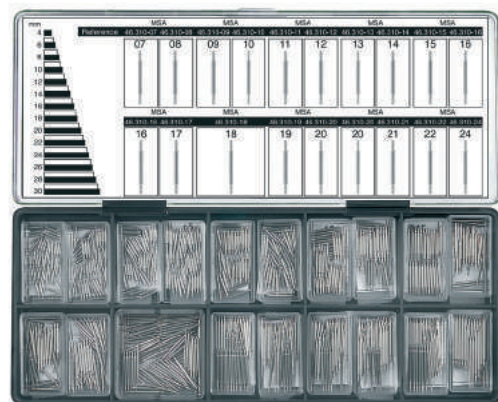

Assortiment de barrettes double sécurité ; acier inoxydable.
 Assortment of double flanged spring bars ; stainless steel.
 Sortiment von Doppel-Ansatz Federstege ; Edelstahl.
 Surtido de pasadores doble seguridad ; acero inoxidable.
 Assortimento di anse doppia sicurezza ; acciaio inossidabile.
 Sortido de pinos dupla segurança ; aço inoxidável.

MSA	Qt.	Kg
99.060	1'000x	0.444

Contenu - Contents - Inhalt - Contenido - Contenuto - Conteúdo :
17 modèles - models - Modelle - modelos - modelli - modelos
1x MSA15.003
50x MSA46.310-07 /-08 /-09 /-10 /-11 /-12
/-13 /-14 /-15 /-17 /-19 /-21 /-22 /-24
100x MSA46.310-16 /-18 /-20

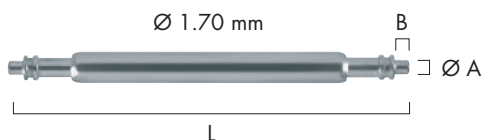

Barrette double sécurité; acier inoxydable.
 Double flanged spring bar; stainless steel.
 Doppel-Ansatz Federsteg; Edelstahl.
 Pasador doble seguridad; acero inoxidable.
 Ansa doppia sicurezza; acciaio inossidabile.
 Pino dupla segurança; aço inoxidável.

100
pcs

MSA	L mm	Ø A x B mm	Kg
46.315-18	18	0.80 x 0.80	0.019
46.315-19	19	0.80 x 0.80	0.020
46.315-20	20	0.80 x 0.80	0.020
46.315-21	21	0.80 x 0.80	0.022

MSA	L mm	Ø A x B mm	Kg
46.315-22	22	0.80 x 0.80	0.022
46.315-23	23	0.80 x 0.80	0.022
46.315-24	24	0.80 x 0.80	0.023

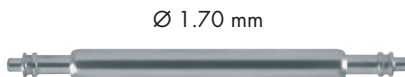

Assortiment de barrettes double sécurité; acier inoxydable.
 Assortment of double flanged spring bars; stainless steel.
 Sortiment von Doppel-Ansatz Federsteg; Edelstahl.
 Surtido de pasadores doble seguridad; acero inoxidable.
 Assortimento di anse doppia sicurezza; acciaio inossidabile.
 Sortido de pinos dupla segurança; aço inoxidável.

MSA	Qt.	Kg
99.154	60x	0.040

Contenu - Contents - Inhalt - Contenido - Contenuto - Conteúdo :
6 modèles - models - Modelle - modelos - modelli - modelos
10x MSA46.315-18 /-20 /-21 /-22 /-23 /-24

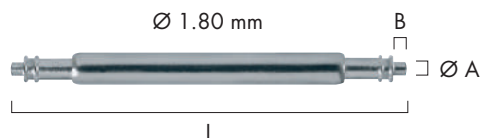

Barrette double sécurité ; acier inoxydable.
Double flanged spring bar ; stainless steel.
 Doppel-Ansatz Federsteg ; Edelstahl.
Pasador doble seguridad ; acero inoxidable.
 Ansa doppia sicurezza ; acciaio inossidabile.
Pino dupla segurança ; aço inoxidável.

100
pcs

MSA	L mm	Ø A x B mm	Kg
46.320-08	8	0.80 x 0.80	0.010
46.320-10	10	0.80 x 0.80	0.013
46.320-11	11	0.80 x 0.80	0.013
46.320-12	12	0.80 x 0.80	0.014
46.320-13	13	0.80 x 0.80	0.017
46.320-14	14	0.80 x 0.80	0.017
46.320-15	15	0.80 x 0.80	0.018
46.320-16	16	0.80 x 0.80	0.018
46.320-17	17	0.80 x 0.80	0.020
46.320-18	18	0.80 x 0.80	0.021
46.320-19	19	0.80 x 0.80	0.021
46.320-20	20	0.80 x 0.80	0.022
46.320-21	21	0.80 x 0.80	0.023
46.320-22	22	0.80 x 0.80	0.024
46.320-23	23	0.80 x 0.80	0.024
46.320-24	24	0.80 x 0.80	0.025
46.320-26	26	0.80 x 0.80	0.026
46.320-28	28	0.80 x 0.80	0.028
46.320-30	30	0.80 x 0.80	0.029
46.320-32	32	0.80 x 0.80	0.029
46.320-34	34	0.80 x 0.80	0.032
46.320-36	36	0.80 x 0.80	0.033
46.320-38	38	0.80 x 0.80	0.034

10
pcs

MSA	L mm	Ø A x B mm	Kg
46.321-08	8	0.80 x 0.80	0.002
46.321-10	10	0.80 x 0.80	0.002
46.321-11	11	0.80 x 0.80	0.002
46.321-12	12	0.80 x 0.80	0.002
46.321-13	13	0.80 x 0.80	0.002
46.321-14	14	0.80 x 0.80	0.002
46.321-15	15	0.80 x 0.80	0.003
46.321-16	16	0.80 x 0.80	0.003
46.321-17	17	0.80 x 0.80	0.003
46.321-18	18	0.80 x 0.80	0.003
46.321-19	19	0.80 x 0.80	0.003
46.321-20	20	0.80 x 0.80	0.003
46.321-21	21	0.80 x 0.80	0.003
46.321-22	22	0.80 x 0.80	0.003
46.321-23	23	0.80 x 0.80	0.003
46.321-24	24	0.80 x 0.80	0.003
46.321-26	26	0.80 x 0.80	0.004
46.321-28	28	0.80 x 0.80	0.004
46.321-30	30	0.80 x 0.80	0.004
46.321-32	32	0.80 x 0.80	0.004
46.321-34	34	0.80 x 0.80	0.004
46.321-36	36	0.80 x 0.80	0.004
46.321-38	38	0.80 x 0.80	0.004



Ø 1.80 mm



Assortiment de barrettes double sécurité ; acier inoxydable.
 Assortment of double flanged spring bars ; stainless steel.
 Sortiment von Doppel-Ansatz Federstege ; Edelstahl.
 Sortido de pasadores doble seguridad ; acero inoxidable.
 Assortimento di anse doppia sicurezza ; acciaio inossidabile.
 Sortido de pinos dupla segurança ; aço inoxidável.

MSA	Qt.	Kg
99.031	100x	0.047

Contenu - Contents - Inhalt - Contenido - Contenuto - Conteúdo :
10 modèles - models - Modelle - modelos - modelli - modelos
10x MSA46.320-12 /-14 /-16 /-17 /-18 /-19 /-20 /-21 /-22 /-24



Ø 1.80 mm



Assortiment de barrettes double sécurité ; acier inoxydable.
 Assortment of double flanged spring bars ; stainless steel.
 Sortiment von Doppel-Ansatz Federstege ; Edelstahl.
 Sortido de pasadores doble seguridad ; acero inoxidable.
 Assortimento di anse doppia sicurezza ; acciaio inossidabile.
 Sortido de pinos dupla segurança ; aço inoxidável.

MSA	Qt.	Kg
99.156	100x	0.054

Contenu - Contents - Inhalt - Contenido - Contenuto - Conteúdo :
10 modèles - models - Modelle - modelos - modelli - modelos
10x MSA46.320-20 /-22 /-24 /-26 /-28 /-30 /-32 /-34 /-36 /-38

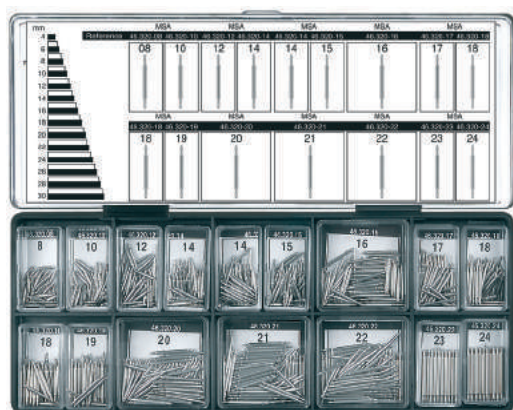

MSA	Qt.	Kg
99.062	1'000x	0.494

Ø 1.80 mm



Assortiment de barrettes double sécurité ; acier inoxydable.
 Assortment of double flanged spring bars ; stainless steel.
 Sortiment von Doppel-Ansatz Federstege ; Edelstahl.
 Surtido de pasadores doble seguridad ; acero inoxidable.
 Assortimento di anse doppia sicurezza ; acciaio inossidabile.
 Sortido de pinos dupla segurança ; aço inoxidável.

Contenu - Contents - Inhalt - Contenido
Contenuto - Conteúdo :

14 modèles - models - Modelle - modelos
modelli - modelos

50x MSA46.320-08 /-10 /-12 /-15 /-17 /-19
/-23 /-24

100x MSA46.320-14 /-16 /-18 /-20 /-21 /-22



MSA	Qt.	Kg
99.157	1000x	0.580

Ø 1.80 mm



Assortiment de barrettes double sécurité ; acier inoxydable.
 Assortment of double flanged spring bars ; stainless steel.
 Sortiment von Doppel-Ansatz Federstege ; Edelstahl.
 Surtido de pasadores doble seguridad ; acero inoxidable.
 Assortimento di anse doppia sicurezza ; acciaio inossidabile.
 Sortido de pinos dupla segurança ; aço inoxidável.

Contenu - Contents - Inhalt - Contenido
Contenuto - Conteúdo :

10 modèles - models - Modelle - modelos
modelli - modelos

100x MSA46.320-22 /-23 /-24 /-26 /-28 /-30
/-32 /-34 /-36 /-38

Ø 1.30 – 1.50 – 1.80 mm



Assortiment de barrettes double sécurité ; acier inoxydable.
 Assortiment of double flanged spring bars ; stainless steel.
 Sortiment von Doppel-Ansatz Federstege ; Edelstahl.
 Surtido de pasadores doble seguridad ; acero inoxidable.
 Assortimento di anse doppia sicurezza ; acciaio inossidabile.
 Sortido de pinos dupla segurança ; aço inoxidável.

Contenu - Contents - Inhalt - Contenido
Contenuto - Conteúdo :

- 40 modèles - models - Modelle - modelos**
- modelli - modelos**
- 1x MSA15.003**
- 10x MSA46.300-07 /-09 /-11 /-13 /-15 ;**
- 46.310-13 /-15 /-17 /-19 /-21 /-24 ; 46.320-15**
- 17 /-19 /-21 /-23 /-24**
- 20x MSA46.300-06 /-08 /-10 /-12 /-14 /-16**
- ; 46.310-08 /-10 /-12 /-14 /-16 /-20 /-22 ;**
- 46.320-08 /-10 /-12 /-14 /-16 /-20 /-22**
- 40x MSA46.300-18 ; 46.310-18 ; 46.320-18**

MSA	Qt.	Kg
99.064	690x	0.438

Ø 1.30 – 1.50 – 1.80 mm



Assortiment de barrettes double sécurité ; acier inoxydable.
 Assortiment of double flanged spring bars ; stainless steel.
 Sortiment von Doppel-Ansatz Federstege ; Edelstahl.
 Surtido de pasadores doble seguridad ; acero inoxidable.
 Assortimento di anse doppia sicurezza ; acciaio inossidabile.
 Sortido de pinos dupla segurança ; aço inoxidável.

Contenu - Contents - Inhalt - Contenido
Contenuto - Conteúdo :

- 32 modèles - models - Modelle - modelos**
- modelli - modelos**
- 10x MSA46.300-12 /-14 /-15 ; 46.310-12 /-14**
- /-15 /-23 /-24**
- 20x MSA46.300-16 /-17 /-18 /-19 /-20 ;**
- 46.310-16 /-17 /-18 /-19 /-20 /-21 /-22 ;**
- 46.320-16 /-18 /-20 /-22**
- 30x MSA46.320-24 /-26 /-28 /-30 /-32 /-34**
- /-36 /-38**

MSA	Qt.	Kg
99.158	640x	0.434

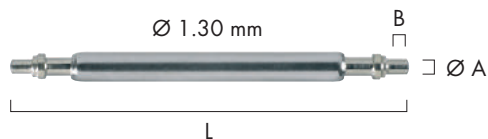

Barrette de sécurité ; acier inoxydable.
 Flanged spring bar ; stainless steel.
 Ansatz Federsteg ; Edelstahl.
 Pasador de seguridad ; acero inoxidable.
 Ansa di sicurezza ; acciaio inossidabile.
 Pino de segurança ; aço inoxidável.

100
pcs

MSA	L mm	Ø A x B mm	Kg
46.201-06.0	6	0.70 x 0.70	0.004
46.201-06.5	6.5	0.70 x 0.70	0.004
46.201-07.0	7	0.70 x 0.70	0.005
46.201-07.5	7.5	0.70 x 0.70	0.005
46.201-08.0	8	0.70 x 0.70	0.006
46.201-08.5	8.5	0.70 x 0.70	0.006
46.201-09.0	9	0.70 x 0.80	0.007
46.201-10.0	10	0.70 x 1.00	0.008
46.201-11.0	11	0.70 x 1.00	0.008
46.201-12.0	12	0.70 x 1.00	0.008
46.201-13.0	13	0.70 x 1.00	0.009
46.201-14.0	14	0.70 x 1.00	0.009

MSA	L mm	Ø A x B mm	Kg
46.201-15.0	15	0.70 x 1.00	0.010
46.201-16.0	16	0.70 x 1.00	0.011
46.201-17.0	17	0.70 x 1.00	0.012
46.201-18.0	18	0.70 x 1.00	0.013
46.201-19.0	19	0.70 x 1.00	0.014
46.201-20.0	20	0.70 x 1.00	0.014
46.201-21.0	21	0.70 x 1.00	0.015
46.201-22.0	22	0.70 x 1.00	0.015
46.201-23.0	23	0.70 x 1.00	0.016
46.201-24.0	24	0.70 x 1.00	0.016
46.201-25.0	25	0.70 x 1.00	0.016
46.201-26.0	26	0.70 x 1.00	0.017

MSA 46.201-08.0	MSA 46.201-10.0	MSA 46.201-12.0	MSA 46.201-14.0	MSA 46.201-16.0	MSA 46.201-18.0
Barrettes de sécurité ac.inox Flanged spring bars st. steel Pasadores de seguridad ac.inox Anse di sicurezza acc.inox					Ø 1.30 mm
MSA 99.159					60 pcs
MSA 46.201-19.0	MSA 46.201-20.0	MSA 46.201-22.0	MSA 46.201-24.0	MSA 46.201-25.0	MSA 46.201-26.0

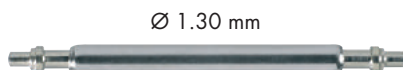

Assortiment de barrettes de sécurité ; acier inoxydable.
 Assortment of flanged spring bars ; stainless steel.
 Sortiment von Ansatz Federsteg ; Edelstahl.
 Surtido de pasadores de seguridad ; acero inoxidable.
 Assortimento di anse di sicurezza ; acciaio inossidabile.
 Sortido de pinos de segurança ; aço inoxidável.

MSA	Qt.	Kg
99.159	60x	0.044

Contenu - Contents - Inhalt - Contenido - Contenuto - Conteúdo :
12 modèles - models - Modelle - modelos - modelli - modelos
5x MSA46.201-08.0 /-10.0 /-12.0 /-14.0 /-16.0 /-18.0 /-19.0
/-20.0 /-22.0 /-24.0 /-25.0 /-26.0

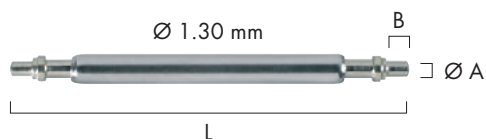

Barrette de sécurité ; maillechort.
 Flanged spring bar ; nickel silver.
 Ansatz Federsteg ; Neusilber.
 Pasador de seguridad ; alpaca.
 Ansa di sicurezza ; argenteone.
 Pino de segurança ; níquel prateado.

100
pcs

MSA	L mm	Ø A x B mm	Kg
46.200-06.0	6	0.70 x 0.70	0.014
46.200-07.0	7	0.70 x 0.70	0.014
46.200-08.0	8	0.70 x 0.70	0.014
46.200-09.0	9	0.70 x 0.80	0.014
46.200-10.0	10	0.70 x 1.00	0.014
46.200-11.0	11	0.70 x 1.00	0.014
46.200-12.0	12	0.70 x 1.00	0.014
46.200-13.0	13	0.70 x 1.00	0.014
46.200-14.0	14	0.70 x 1.00	0.014
46.200-15.0	15	0.70 x 1.00	0.014

MSA	L mm	Ø A x B mm	Kg
46.200-16.0	16	0.70 x 1.00	0.014
46.200-17.0	17	0.70 x 1.00	0.014
46.200-18.0	18	0.70 x 1.00	0.014
46.200-19.0	19	0.70 x 1.00	0.014
46.200-20.0	20	0.70 x 1.00	0.014
46.200-21.0	21	0.70 x 1.00	0.014
46.200-22.0	22	0.70 x 1.00	0.014
46.200-23.0	23	0.70 x 1.00	0.014
46.200-24.0	24	0.70 x 1.00	0.014

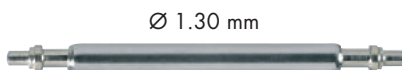

Assortiment de barrettes de sécurité ; maillechort.
 Assortment of flanged spring bars ; nickel silver.
 Sortiment von Ansatz Federsteg ; Neusilber.
 Surtido de pasadores de seguridad ; alpaca.
 Assortimento di anse di sicurezza ; argenteone.
 Sortido de pinos de segurança ; níquel prateado.

MSA	Qt.	Kg
99.099	60x	0.033

Contenu - Contents - Inhalt - Contenido - Contenuto - Conteúdo :
12 modèles - models - Modelle - modelos - modelli - modelos
5x MSA46.200-06.0 /-07.0 /-08.0 /-09.0 /-10.0 /-12.0 /-13.0
/-14.0 /-15.0 /-16.0 /-18.0 /-20.0

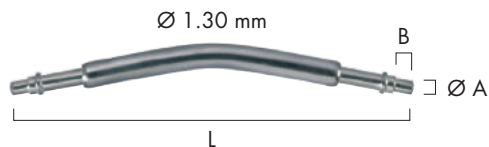

Barrette de sécurité courbée; maillechort.
 Curved flanged spring bar; nickel silver.
 Gebogener Ansatz Federsteg; Neusilber.
 Pasador de seguridad curvado; alpaca.
 Ansa di sicurezza curva; argentine.
 Pinos de segurança curvados; níquel prateado.

100
pcs

MSA	L mm	Ø A x B mm	Kg
46.272-10.0	10	0.70 x 1.00	0.014
46.272-12.0	12	0.70 x 1.00	0.014
46.272-13.0	13	0.70 x 1.00	0.014
46.272-14.0	14	0.70 x 1.00	0.014
46.272-15.0	15	0.70 x 1.00	0.014
46.272-16.0	16	0.70 x 1.00	0.014
46.272-17.0	17	0.70 x 1.00	0.014

MSA	L mm	Ø A x B mm	Kg
46.272-18.0	18	0.70 x 1.00	0.014
46.272-19.0	19	0.70 x 1.00	0.014
46.272-20.0	20	0.70 x 1.00	0.014
46.272-21.0	21	0.70 x 1.00	0.014
46.272-22.0	22	0.70 x 1.00	0.014
46.272-24.0	24	0.70 x 1.00	0.014



Ø 1.30 mm



Assortiment de barrettes de sécurité courbées; maillechort.
 Assortiment of curved flanged spring bars; nickel silver.
 Sortiment von gebogene Ansatz Federsteg; Neusilber.
 Surtido de pasadores de seguridad curvados; alpaca.
 Assortimento di anse di sicurezza curve; argentine.
 Sortido de pinos de segurança curvados; níquel prateado.

MSA	Qt.	Kg
99.104	60x	0.036

Contenu - Contents - Inhalt - Contenido - Contenuto - Conteúdo :
10 modèles - models - Modelle - modelos - modelli - modelos
6x MSA46.272-12.0 /-14.0 /-16.0 /-17.0 /-18.0 /-19.0 /-20.0
/-21.0 /-22.0 /-24.0

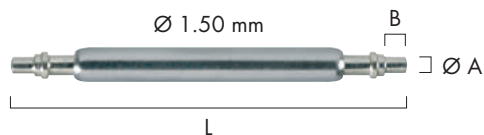

Barrette de sécurité ; acier inoxydable.
 Flanged spring bar ; stainless steel.
 Ansatz Federsteg ; Edelstahl.
 Pasador de seguridad ; acero inoxidable.
 Ansa di sicurezza ; acciaio inossidabile.
 Pino de segurança ; aço inoxidável.



MSA	L mm	Ø A x B mm	Kg
46.211-06.0	6	0.70 x 0.70	0.006
46.211-07.0	7	0.70 x 0.70	0.007
46.211-08.0	8	0.70 x 0.70	0.008
46.211-09.0	9	0.75 x 0.80	0.009
46.211-10.0	10	0.75 x 1.00	0.010
46.211-11.0	11	0.75 x 1.00	0.011
46.211-12.0	12	0.75 x 1.00	0.012
46.211-13.0	13	0.75 x 1.00	0.012
46.211-14.0	14	0.75 x 1.00	0.012
46.211-15.0	15	0.75 x 1.00	0.015
46.211-16.0	16	0.75 x 1.00	0.015
46.211-17.0	17	0.75 x 1.00	0.016
46.211-18.0	18	0.75 x 1.00	0.017
46.211-19.0	19	0.75 x 1.00	0.018
46.211-20.0	20	0.75 x 1.00	0.019
46.211-21.0	21	0.75 x 1.00	0.019

MSA	L mm	Ø A x B mm	Kg
46.211-22.0	22	0.75 x 1.00	0.020
46.211-23.0	23	0.75 x 1.00	0.021
46.211-24.0	24	0.75 x 1.00	0.021
46.211-25.0	25	0.75 x 1.00	0.023
46.211-26.0	26	0.75 x 1.00	0.024
46.211-27.0	27	0.75 x 1.00	0.024
46.211-28.0	28	0.75 x 1.00	0.025
46.211-29.0	29	0.75 x 1.00	0.025
46.211-30.0	30	0.75 x 1.00	0.026
46.211-31.0	31	0.75 x 1.00	0.026
46.211-32.0	32	0.75 x 1.00	0.028
46.211-33.0	33	0.75 x 1.00	0.028
46.211-34.0	34	0.75 x 1.00	0.029
46.211-35.0	35	0.75 x 1.00	0.029
46.211-36.0	36	0.75 x 1.00	0.032
46.211-38.0	38	0.75 x 1.00	0.033

MSA 46.211	MSA 46.211	MSA 46.211	MSA 46.211	MSA 46.211	MSA 46.211
06.0	08.0	10.0	12.0	14.0	16.0



MSA	Qt.	Kg
99.197	120x	0.054

Ø 1.50 mm



Assortiment de barrettes de sécurité ; acier inoxydable.
 Assortment of flanged spring bars ; stainless steel.
 Sortiment von Ansatz Federstege ; Edelstahl.
 Surtido de pasadores de seguridad ; acero inoxidable.
 Assortimento di anse di sicurezza ; acciaio inossidabile.
 Sortido de pinos de segurança ; aço inoxidável.

Contenu - Contents - Inhalt - Contenido - Contenuto - Conteúdo :
12 modèles - models - Modelle - modelos - modelli - modelos
10x MSA46.211-06.0 /-08.0 /-10.0 /-12.0 /-14.0 /-16.0 /-17.0
/-18.0 /-19.0 /-20.0 /-21.0 /-22.0

Assortiment MSA 99.142		100 pcs
barrettes de sécurité flanged spring bars pasadores de seguridad anse di sicurezza		ø 1.50 mm



MSA	Qt.	Kg
99.142	100x	0.052

Ø 1.50 mm



Assortiment de barrettes de sécurité ; acier inoxydable.
 Assortment of flanged spring bars ; stainless steel.
 Sortiment von Ansatz Federstege ; Edelstahl.
 Surtido de pasadores de seguridad ; acero inoxidable.
 Assortimento di anse di sicurezza ; acciaio inossidabile.
 Sortido de pinos de segurança ; aço inoxidável.

Contenu - Contents - Inhalt - Contenido - Contenuto - Conteúdo :
10 modèles - models - Modelle - modelos - modelli - modelos
10x MSA46.211-23.0 /-24.0 /-25.0 /-26.0 /-27.0 /-28.0 /-29.0
/-30.0 /-31.0 /-32.0

Assortiment MSA 99.198		100 pcs
barrettes de sécurité ac. inox flanged spring bars st. steel pasadores de seguridad ac. inox anse di sicurezza acc. inossid.		ø 1.50 mm



MSA	Qt.	Kg
99.198	100x	0.054

Ø 1.50 mm



Assortiment de barrettes de sécurité ; acier inoxydable.
 Assortment of flanged spring bars ; stainless steel.
 Sortiment von Ansatz Federstege ; Edelstahl.
 Surtido de pasadores de seguridad ; acero inoxidable.
 Assortimento di anse di sicurezza ; acciaio inossidabile.
 Sortido de pinos de segurança ; aço inoxidável.

Contenu - Contents - Inhalt - Contenido - Contenuto - Conteúdo :
10 modèles - models - Modelle - modelos - modelli - modelos
10x MSA46.211-24.0 /-25.0 /-26.0 /-28.0 /-30.0 /-32.0 /-33.0
/-34.0 /-36.0 /-38.0

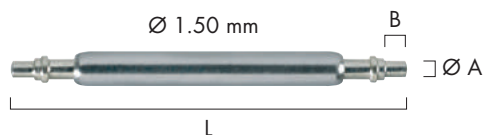

Barrette de sécurité ; maillechort.
 Flanged spring bar ; nickel silver.
 Ansatz Federsteg ; Neusilber.
 Pasador de seguridad ; alpaca.
 Ansa di sicurezza ; argenteone.
 Pino de segurança ; níquel prateado.

100
pcs

MSA	L mm	Ø A x B mm	Kg
46.210-06.0	6	0.70 x 0.70	0.018
46.210-07.0	7	0.70 x 0.70	0.018
46.210-08.0	8	0.70 x 0.70	0.018
46.210-09.0	9	0.75 x 0.80	0.018
46.210-10.0	10	0.75 x 1.00	0.018
46.210-11.0	11	0.75 x 1.00	0.018
46.210-12.0	12	0.75 x 1.00	0.018
46.210-13.0	13	0.75 x 1.00	0.018
46.210-14.0	14	0.75 x 1.00	0.018
46.210-15.0	15	0.75 x 1.00	0.018

MSA	L mm	Ø A x B mm	Kg
46.210-16.0	16	0.75 x 1.00	0.018
46.210-17.0	17	0.75 x 1.00	0.018
46.210-18.0	18	0.75 x 1.00	0.018
46.210-19.0	19	0.75 x 1.00	0.018
46.210-20.0	20	0.75 x 1.00	0.018
46.210-21.0	21	0.75 x 1.00	0.018
46.210-22.0	22	0.75 x 1.00	0.018
46.210-23.0	23	0.75 x 1.00	0.018
46.210-24.0	24	0.75 x 1.00	0.018

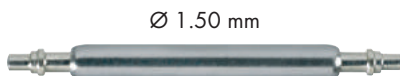

Assortiment de barrettes de sécurité ; maillechort.
 Assortment of flanged spring bars ; nickel silver.
 Sortiment von Ansatz Federstege ; Neusilber.
 Surtido de pasadores de seguridad ; alpaca.
 Assortimento di anse di sicurezza ; argenteone.
 Sortido de pinos de segurança ; níquel prateado.

MSA	Qt.	Kg
99.100	60x	0.038

Contenu - Contents - Inhalt - Contenido - Contenuto - Conteúdo :
10 modèles - models - Modelle - modelos - modelli - modelos
6x MSA46.210-08.0 /-10.0 /-12.0 /-13.0 /-14.0 /-15.0 /-16.0
/-18.0 /-20.0 /-22.0

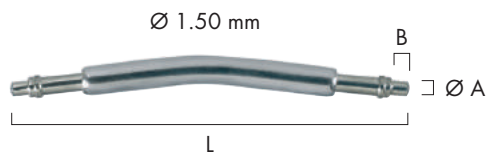

Barrette de sécurité courbée ; maillechort.
 Curved flanged spring bar ; nickel silver.
 Gebogener Ansatz Federsteg ; Neusilber.
 Pasador de seguridad curvado ; alpaca.
 Ansa di sicurezza curva ; argenteo.
 Pino de segurança curvado ; níquel prateado.

100
pcs

MSA	L mm	Ø A x B mm	Kg
46.271-10.0	10	0.75 x 1.00	0.018
46.271-11.0	11	0.75 x 1.00	0.018
46.271-12.0	12	0.75 x 1.00	0.018
46.271-13.0	13	0.75 x 1.00	0.018
46.271-14.0	14	0.75 x 1.00	0.018
46.271-15.0	15	0.75 x 1.00	0.018
46.271-16.0	16	0.75 x 1.00	0.018

MSA	L mm	Ø A x B mm	Kg
46.271-17.0	17	0.75 x 1.00	0.018
46.271-18.0	18	0.75 x 1.00	0.018
46.271-19.0	19	0.75 x 1.00	0.018
46.271-20.0	20	0.75 x 1.00	0.018
46.271-21.0	21	0.75 x 1.00	0.018
46.271-22.0	22	0.75 x 1.00	0.018



Ø 1.50 mm



Assortiment de barrettes de sécurité courbées ; maillechort.
 Assortment of curved flanged spring bars ; nickel silver.
 Sortiment von gebogene Ansatz Federsteg ; Neusilber.
 Surtido de pasadores de seguridad curvados ; alpaca.
 Assortimento di anse di sicurezza curve ; argenteo.
 Sortido de pinos de segurança curvados ; níquel prateado.

MSA	Qt.	Kg
99.103	60x	0.038

Contenu - Contents - Inhalt - Contenido - Contenuto - Conteúdo :
10 modèles - models - Modelle - modelos - modelli - modelos
6x MSA46.271-10.0 /-12.0 /-13.0 /-14.0 /-15.0 /-16.0 /-17.0
/-18.0 /-20.0 /-22.0



Barrette de sécurité; acier inoxydable.
 Flanged spring bar; stainless steel.
 Ansatz Federsteg; Edelstahl.
 Pasador de seguridad; acero inoxidable.
 Ansa di sicurezza; acciaio inossidabile.
 Pino de segurança; aço inoxidável.

100 pcs

MSA	L mm	Ø A x B mm	Kg
46.220-09.0	9	0.90 x 1.00	0.024
46.220-10.0	10	0.90 x 1.00	0.024
46.220-11.0	11	0.90 x 1.00	0.024
46.220-12.0	12	0.90 x 1.00	0.024
46.220-13.0	13	0.90 x 1.00	0.024
46.220-14.0	14	0.90 x 1.00	0.024
46.220-15.0	15	0.90 x 1.00	0.024
46.220-16.0	16	0.90 x 1.00	0.024
46.220-17.0	17	0.90 x 1.00	0.024
46.220-18.0	18	0.90 x 1.00	0.024
46.220-19.0	19	0.90 x 1.00	0.024
46.220-20.0	20	0.90 x 1.00	0.024
46.220-21.0	21	0.90 x 1.00	0.024

MSA	L mm	Ø A x B mm	Kg
46.220-22.0	22	0.90 x 1.00	0.024
46.220-23.0	23	0.90 x 1.00	0.024
46.220-24.0	24	0.90 x 1.00	0.024
46.220-25.0	25	0.90 x 1.00	0.024
46.220-26.0	26	0.90 x 1.00	0.024
46.220-28.0	28	0.90 x 1.00	0.024
46.220-30.0	30	0.90 x 1.00	0.024
46.220-32.0	32	0.90 x 1.00	0.024
46.220-34.0	34	0.90 x 1.00	0.024
46.220-36.0	36	0.90 x 1.00	0.024
46.220-37.0	37	0.90 x 1.00	0.024
46.220-38.0	38	0.90 x 1.00	0.024

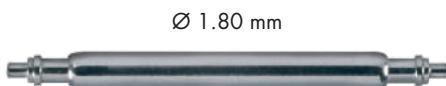

Assortiment de barrettes de sécurité; acier inoxydable.
 Assortment of flanged spring bars; stainless steel.
 Sortiment von Ansatz Federsteg; Edelstahl.
 Surtido de pasadores de seguridad; acero inoxidable.
 Assortimento di anse di sicurezza; acciaio inossidabile.
 Sortido de pinos de segurança; aço inoxidável.

MSA	Qt.	Kg
99.101	60x	0.042

Contenu - Contents - Inhalt - Contenido - Contenuto - Conteúdo :
10 modèles - models - Modelle - modelos - modelli - modelos
6x MSA46.220-12.0 /-14.0 /-16.0 /-17.0 /-18.0 /-19.0 /-20.0
/-21.0 /-22.0 /-24.0



Ø 1.80 mm



Assortiment de barrettes de sécurité ; acier inoxydable.
 Assortment of flanged spring bars ; stainless steel.
 Sortiment von Ansatz Federstege ; Edelstahl.
 Surtido de pasadores de seguridad ; acero inoxidable.
 Assortimento di anse di sicurezza ; acciaio inossidabile.
 Sortido de pinos de segurança ; aço inoxidável.

Contenu - Contents - Inhalt - Contenido - Contenuto - Conteúdo :
10 modèles - models - Modelle - modelos - modelli - modelos
6x MSA46.220-22.0 /-24.0 /-25.0 /-26.0 /-28.0 /-30.0 /-32.0
/-34.0 /-36.0 /-38.0

MSA	Qt.	Kg
99.196	60x	0.048

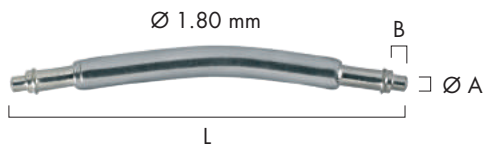

Barrette de sécurité courbée ; maillechort.
 Curved flanged spring bar ; nickel silver.
 Gebogener Ansatz Federsteg ; Neusilber.
 Pasador de seguridad curvado ; alpaca.
 Ansa di sicurezza curva ; argenteone.
 Pino de segurança curvado ; níquel prateado.

100
pcs

MSA	L mm	Ø A x B mm	Kg
46.270-10.0	10	0.90 x 1.00	0.025
46.270-11.0	11	0.90 x 1.00	0.025
46.270-12.0	12	0.90 x 1.00	0.025
46.270-13.0	13	0.90 x 1.00	0.025
46.270-14.0	14	0.90 x 1.00	0.025
46.270-15.0	15	0.90 x 1.00	0.025
46.270-16.0	16	0.90 x 1.00	0.025

MSA	L mm	Ø A x B mm	Kg
46.270-17.0	17	0.90 x 1.00	0.025
46.270-18.0	18	0.90 x 1.00	0.025
46.270-19.0	19	0.90 x 1.00	0.025
46.270-20.0	20	0.90 x 1.00	0.025
46.270-21.0	21	0.90 x 1.00	0.025
46.270-22.0	22	0.90 x 1.00	0.025
46.270-24.0	24	0.90 x 1.00	0.025

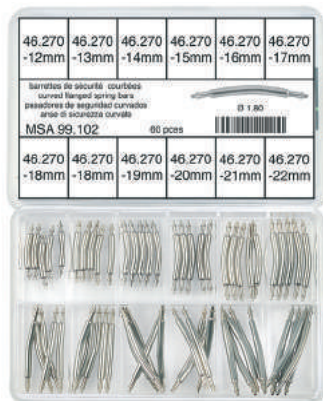

Ø 1.80 mm



Assortiment de barrettes de sécurité courbées ; maillechort.
 Assortiment of curved flanged spring bars ; nickel silver.
 Sortiment von gebogene Ansatz Federsteg ; Neusilber.
 Surtido de pasadores de seguridad curvados ; alpaca.
 Assortimento di anse di sicurezza curve ; argenteone.
 Sortido de pinos de segurança curvados ; níquel prateado.

MSA	Qt.	Kg
99.102	60x	0.040

Contenu - Contents - Inhalt - Contenido - Contenuto - Conteúdo :
11 modèles - models - Modelle - modelos - modelli - modelos
5x MSA46.270-12.0 /-13.0 /-14.0 /-15.0 /-16.0 /-17.0 /-19.0
/-20.0 /-21.0 /-22.0
10x MSA46.270-18.0



Barrette de sécurité ; acier inoxydable.
 Flanged spring bar ; stainless steel.
 Ansatz Federsteg ; Edelstahl.
 Pasador de seguridad ; acero inoxidable.
 Ansa di sicurezza ; acciaio inossidabile.
 Pino de segurança ; aço inoxidável.

100
pcs

MSA	L mm	Ø A x B mm	Kg
46.221-10.0	10	1.00 x 1.00	0.017
46.221-11.0	11	1.00 x 1.00	0.018
46.221-12.0	12	1.00 x 1.00	0.019
46.221-13.0	13	1.00 x 1.00	0.020
46.221-14.0	14	1.00 x 1.00	0.021
46.221-15.0	15	1.00 x 1.00	0.023

MSA	L mm	Ø A x B mm	Kg
46.221-16.0	16	1.00 x 1.00	0.024
46.221-17.0	17	1.00 x 1.00	0.026
46.221-18.0	18	1.00 x 1.00	0.027
46.221-19.0	19	1.00 x 1.00	0.027
46.221-20.0	20	1.00 x 1.00	0.028



Ø 2.00 mm



Assortiment de barrettes de sécurité ; acier inoxydable.
 Assortment of flanged spring bars ; stainless steel.
 Sortiment von Ansatz Federsteg ; Edelstahl.
 Surtido de pasadores de seguridad ; acero inoxidable.
 Assortimento di anse di sicurezza ; acciaio inossidabile.
 Sortido de pinos de segurança ; aço inoxidável.

MSA	Qt.	Kg
99.125	50x	0.025

Contenu - Contents - Inhalt - Contenido - Contenuto - Conteúdo :
11 modèles - models - Modelle - modelos - modelli - modelos
4x MSA46.221-10.0 /-11.0 /-12.0 /-13.0 /-14.0 /-15.0 /-17.0
/-19.0
6x MSA46.221-16.0 /-18.0 /-20.0



Barrette de sécurité télescopique ; acier inoxydable.

Telescopic flanged spring bar ; stainless steel.

Teleskopischer Ansatz Federsteg ; Edelstahl.

Pasador de seguridad telescópico ; acero inoxidable.

Ansa di sicurezza telescopica ; acciaio inossidabile.

Pino de segurança telescópico ; aço inoxidável.

100
pcs

MSA	L mm	Ø A x B mm	Kg
46.221-2022	20-22	1.00 x 1.00	0.030
46.221-2224	22-24	1.00 x 1.00	0.034
46.221-2426	24-26	1.00 x 1.00	0.036
46.221-2628	26-28	1.00 x 1.00	0.038
46.221-2830	28-30	1.00 x 1.00	0.040
46.221-3032	30-32	1.00 x 1.00	0.043

MSA	L mm	Ø A x B mm	Kg
46.221-3234	32-34	1.00 x 1.00	0.044
46.221-3436	34-36	1.00 x 1.00	0.046
46.221-3638	36-38	1.00 x 1.00	0.048
46.221-3840	38-40	1.00 x 1.00	0.049
46.221-4042	40-42	1.00 x 1.00	0.051

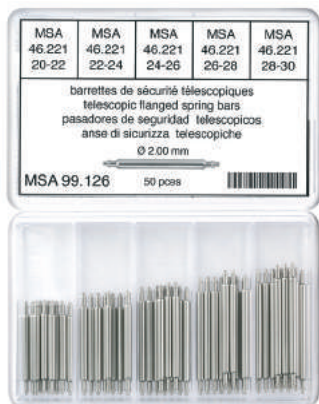

Ø 2.00 mm



Assortiment de barrettes de sécurité télescopiques ; acier inoxydable.
 Assortiment of telescopic flanged spring bars ; stainless steel.
 Sortiment von teleskopische Ansatz Federstege ; Edelstahl.
 Surtido de pasadores de seguridad telescópicos ; acero inoxidable.
 Assortimento di anse di sicurezza telescopiche ; acciaio inossidabile.
 Sortido de pinos de segurança telescópicos ; aço inoxidável.

MSA	Qt.	Kg
99.126	50x	0.024

Contenu - Contents - Inhalt - Contenido - Contenuto - Conteúdo :
5 modèles - models - Modelle - modelos - modelli - modelos
10x MSA46.221-2022 /-2224 /-2426 /-2628 /-2830



Ø 2.00 mm



Assortiment de barrettes de sécurité télescopiques ; acier inoxydable.
 Assortiment of telescopic flanged spring bars ; stainless steel.
 Sortiment von teleskopische Ansatz Federstege ; Edelstahl.
 Surtido de pasadores de seguridad telescópicos ; acero inoxidable.
 Assortimento di anse di sicurezza telescopiche ; acciaio inossidabile.
 Sortido de pinos de segurança telescópicos ; aço inoxidável.

MSA	Qt.	Kg
99.141	36x	0.028

Contenu - Contents - Inhalt - Contenido - Contenuto - Conteúdo :
6 modèles - models - Modelle - modelos - modelli - modelos
6x MSA46.221-3032 /-3234 /-3436 /-3638 /-3840 /-4042

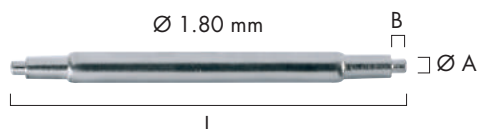

Barrette universelle télescopique ; acier inoxydable.
 Telescopic universal spring bar ; stainless steel.
 Teleskopischer universeller Federsteg ; Edelstahl.
 Pasador universal telescópico ; acero inoxidable.
 Ansa universale telescopica ; acciaio inossidabile.
 Pino universal telescópico ; aço inoxidável.

100
pcs

MSA	L mm	Ø A x B mm	Kg
46.600-0710	7-10	0.80 x 1.00	0.020
46.600-0812	8-12	0.80 x 1.00	0.020
46.600-0914	9-14	0.80 x 1.00	0.020
46.600-1318	13-18	0.80 x 1.00	0.020
46.600-1521	15-21	0.80 x 1.00	0.020
46.600-1723	17-23	0.80 x 1.00	0.020

MSA	L mm	Ø A x B mm	Kg
46.600-1824	18-24	0.80 x 1.00	0.020
46.600-2026	20-26	0.80 x 1.00	0.020
46.600-2430	24-30	0.80 x 1.00	0.020
46.600-2834	28-34	0.80 x 1.00	0.020
46.600-3238	32-38	0.80 x 1.00	0.020



Ø 1.80 mm



Assortiment de barrettes universelles télescopiques ; acier inoxydable.
 Assortment of telescopic universal spring bars ; stainless steel.
 Sortiment von teleskopische universelle Federsteg ; Edelstahl.
 Surtido de pasadores universales telescópicos ; acero inoxidable.
 Assortimento di anse universali telescopiche ; acciaio inossidabile.
 Sortido de pinos universais telescópicos ; aço inoxidável.

MSA	Qt.	Kg
99.199	100x	0.050

Contenu - Contents - Inhalt - Contenido - Contenuto - Conteúdo :
10 modèles - models - Modelle - modelos - modelli - modelos
10x MSA46.600-0812 /-0914 /-1318 /-1521 /-1723 /-1824
/-2026 /-2430 /-2834 /-3238



Barrette universelle télescopique ; maillechort.
 Universal telescopic spring bar ; nickel silver.
 Teleskopischer universeller Federsteg ; Neusilber.
 Pasador universal telescópico ; alpaca.
 Ansa universale telescopica ; argentine.
 Pino universal telescópico ; níquel plateado.



MSA	L mm	Ø A x B mm	Kg
46.500-0812	8-12	0.75 x 1.00	0.023
46.500-1015	10-15	0.75 x 1.00	0.023
46.500-1218	12-18	0.80 x 1.50	0.023
46.500-1522	15-22	0.80 x 1.50	0.023
46.500-1824	18-24	0.80 x 1.50	0.023

MSA	L mm	Ø A x B mm	Kg
46.500-2027	20-27	0.80 x 1.50	0.023
46.500-2330	23-30	0.80 x 1.50	0.023
46.500-2532	25-32	0.80 x 1.50	0.023
46.500-3037	30-37	0.80 x 1.50	0.023

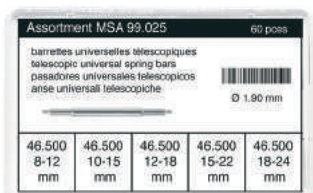

Ø 1.90 mm



Assortiment de barrettes universelles télescopiques ; maillechort.
Assortiment of universal telescopic spring bars ; nickel silver.
 Sortiment von teleskopische universelle Federstege ; Neusilber.
Surtido de pasadores universales telescópicos ; alpaca.
 Assortimento di anse universali telescopiche ; argentone.
Sortido de pinos universais telescópicos ; níquel prateado.

MSA	Qt.	Kg
99.025	60x	0.037

Contenu - Contents - Inhalt - Contenido - Contenuto - Conteúdo :
5 modèles - models - Modelle - modelos - modelli - modelos
12x MSA46.500-0812 /-1015 /-1218 /-1522 /-1824



Ø 1.90 mm



Assortiment de barrettes universelles télescopiques ; maillechort.
Assortiment of universal telescopic spring bars ; nickel silver.
 Sortiment von teleskopische universelle Federstege ; Neusilber.
Surtido de pasadores universales telescópicos ; alpaca.
 Assortimento di anse universali telescopiche ; argentone.
Sortido de pinos universais telescópicos ; níquel prateado.

MSA	Qt.	Kg
99.219	60x	0.045

Contenu - Contents - Inhalt - Contenido - Contenuto - Conteúdo :
5 modèles - models - Modelle - modelos - modelli - modelos
12x MSA46.500-1824 /-2027 /-2330 /-2532 /-3037

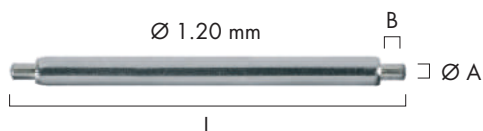

Barrette simple ; maillechort.
 Regular spring bar ; nickel silver.
 Einfacher Federsteg ; Neusilber.
 Pasador sencillo ; alpaca.
 Ansa semplice ; argentone.
 Pino simples ; níquel plateado.

100
pcs

MSA	L mm	Ø A x B mm	Kg
46.000-05.0	5	0.70 x 0.80	0.010
46.000-05.5	5.5	0.70 x 0.80	0.010
46.000-06.0	6	0.70 x 1.00	0.010
46.000-06.5	6.5	0.70 x 1.00	0.010
46.000-07.0	7	0.70 x 1.00	0.010
46.000-07.5	7.5	0.70 x 1.00	0.010
46.000-08.0	8	0.70 x 1.00	0.010
46.000-08.5	8.5	0.70 x 1.00	0.010
46.000-09.0	9	0.70 x 1.00	0.010
46.000-10.0	10	0.70 x 1.00	0.010
46.000-11.0	11	0.70 x 1.00	0.010
46.000-12.0	12	0.70 x 1.00	0.010

MSA	L mm	Ø A x B mm	Kg
46.000-13.0	13	0.70 x 1.00	0.010
46.000-14.0	14	0.70 x 1.00	0.010
46.000-15.0	15	0.70 x 1.00	0.010
46.000-16.0	16	0.70 x 1.00	0.010
46.000-17.0	17	0.70 x 1.00	0.010
46.000-18.0	18	0.70 x 1.00	0.010
46.000-19.0	19	0.70 x 1.00	0.010
46.000-20.0	20	0.70 x 1.00	0.010
46.000-21.0	21	0.70 x 1.00	0.010
46.000-22.0	22	0.70 x 1.00	0.010
46.000-23.0	23	0.70 x 1.00	0.010
46.000-24.0	24	0.70 x 1.00	0.010

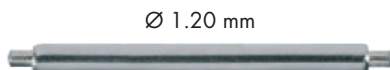
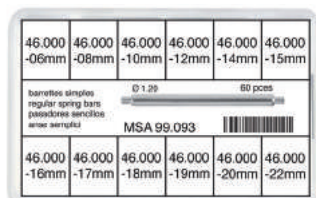

Assortiment de barrettes simples ; maillechort.
 Assortiment of regular spring bars ; nickel silver.
 Sortiment von einfache Federsteg ; Neusilber.
 Surtido de pasadores sencillos ; alpaca.
 Assortimento di anse semplici ; argentone.
 Sortido de pinos simples ; níquel plateado.

MSA	Qt.	Kg
99.093	60x	0.031

Contenu - Contents - Inhalt - Contenido - Contenuto - Conteúdo :
12 modèles - models - Modelle - modelos - modelli - modelos
5x MSA46.000-06.0 /-08.0 /-10.0 /-12.0 /-14.0 /-15.0 /-16.0
/-17.0 /-18.0 /-19.0 /-20.0 /-22.0



Barrette simple ; maillechort.
Regular spring bar ; nickel silver.
 Einfacher Federsteg ; Neusilber.
Pasador sencillo ; alpaca.
 Ansa semplice ; argenteone.
Pino simples ; níquel plateado.



MSA	L mm	Ø A x B mm	Kg
46.005-05.0	5	0.70 x 0.80	0.011
46.005-06.0	6	0.70 x 1.00	0.011
46.005-07.0	7	0.70 x 1.00	0.011
46.005-08.0	8	0.70 x 1.00	0.011
46.005-09.0	9	0.70 x 1.00	0.011
46.005-10.0	10	0.70 x 1.00	0.011
46.005-11.0	11	0.70 x 1.00	0.011
46.005-12.0	12	0.70 x 1.00	0.011
46.005-13.0	13	0.70 x 1.00	0.011
46.005-14.0	14	0.70 x 1.00	0.011

MSA	L mm	Ø A x B mm	Kg
46.005-15.0	15	0.70 x 1.00	0.011
46.005-16.0	16	0.70 x 1.00	0.011
46.005-17.0	17	0.70 x 1.00	0.011
46.005-18.0	18	0.70 x 1.00	0.011
46.005-19.0	19	0.70 x 1.00	0.011
46.005-20.0	20	0.70 x 1.00	0.011
46.005-21.0	21	0.70 x 1.00	0.011
46.005-22.0	22	0.70 x 1.00	0.011
46.005-23.0	23	0.70 x 1.00	0.011
46.005-24.0	24	0.70 x 1.00	0.011

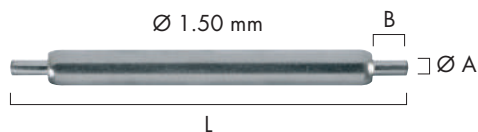

Barrette simple ; maillechort.
 Regular spring bar ; nickel silver.
 Einfacher Federsteg ; Neusilber.
 Pasador sencillo ; alpaca.
 Ansa semplice ; argenteone.
 Pino simples ; níquel plateado.

100
pcs

MSA	L mm	Ø A x B mm	Kg
46.010-05.0	5	0.70 x 0.80	0.015
46.010-06.0	6	0.70 x 0.80	0.015
46.010-07.0	7	0.70 x 0.80	0.015
46.010-08.0	8	0.70 x 0.80	0.015
46.010-09.0	9	0.70 x 1.00	0.015
46.010-10.0	10	0.75 x 1.50	0.015
46.010-11.0	11	0.75 x 1.50	0.015
46.010-12.0	12	0.75 x 1.50	0.015
46.010-13.0	13	0.75 x 1.50	0.015
46.010-14.0	14	0.75 x 1.50	0.015

MSA	L mm	Ø A x B mm	Kg
46.010-15.0	15	0.75 x 1.50	0.015
46.010-16.0	16	0.75 x 1.50	0.015
46.010-17.0	17	0.75 x 1.50	0.015
46.010-18.0	18	0.75 x 1.50	0.015
46.010-19.0	19	0.75 x 1.50	0.015
46.010-20.0	20	0.75 x 1.50	0.015
46.010-21.0	21	0.75 x 1.50	0.015
46.010-22.0	22	0.75 x 1.50	0.015
46.010-23.0	23	0.75 x 1.50	0.015

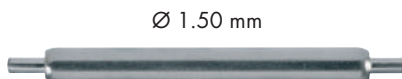
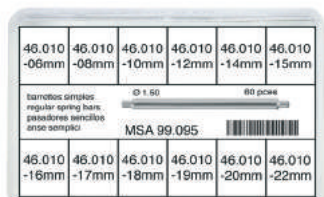

Assortiment de barrettes simples ; maillechort.
 Assortiment of regular spring bars ; nickel silver.
 Sortiment von einfache Federsteg ; Neusilber.
 Surtido de pasadores sencillos ; alpaca.
 Assortimento di anse semplici ; argenteone.
 Sortido de pinos simples ; níquel plateado.

MSA	Qt.	Kg
99.095	60x	0.034

Contenu - Contents - Inhalt - Contenido - Contenuto - Conteúdo :
12 modèles - models - Modelle - modelos - modelli - modelos
5x MSA46.010-06.0 /-08.0 /-10.0 /-12.0 /-14.0 /-15.0 /-16.0
/-17.0 /-18.0 /-19.0 /-20.0 /-22.0



Barrette simple ; maillechort.
Regular spring bar ; nickel silver.
 Einfacher Federsteg ; Neusilber.
Pasador sencillo ; alpaca.
 Ansa semplice ; argenteone.
Pino simples ; níquel plateado.



MSA	L mm	Ø A x B mm	Kg
46.020-09.0	9	0.90 x 1.00	0.021
46.020-10.0	10	0.80 x 1.50	0.021
46.020-11.0	11	0.80 x 1.50	0.021
46.020-12.0	12	0.90 x 2.00	0.021
46.020-13.0	13	0.90 x 2.00	0.021
46.020-14.0	14	0.90 x 2.00	0.021
46.020-15.0	15	0.90 x 2.00	0.021
46.020-16.0	16	0.90 x 2.00	0.021
46.020-17.0	17	0.90 x 2.00	0.021

MSA	L mm	Ø A x B mm	Kg
46.020-18.0	18	0.90 x 2.00	0.021
46.020-19.0	19	0.90 x 2.00	0.021
46.020-20.0	20	0.90 x 2.00	0.021
46.020-21.0	21	0.90 x 2.00	0.021
46.020-22.0	22	0.90 x 2.00	0.021
46.020-23.0	23	0.90 x 2.00	0.021
46.020-24.0	24	0.90 x 2.00	0.021
46.020-36.0	36	0.90 x 2.00	0.021



Ø 1.80 mm



Assortiment de barrettes simples ; maillechort.
Assortiment of regular spring bars ; nickel silver.
 Sortiment von einfache Federsteg ; Neusilber.
Surtido de pasadores sencillos ; alpaca.
 Assortimento di anse semplici ; argenteone.
Sortido de pinos simples ; níquel plateado.

MSA	Qt.	Kg
99.096	60x	0.040

Contenu - Contents - Inhalt - Contenido - Contenuto - Conteúdo :
10 modèles - models - Modelle - modelos - modelli - modelos
6x MSA46.020-10.0 /-12.0 /-14.0 /-16.0 /-17.0 /-18.0 /-19.0
/-20.0 /-22.0 /-24.0

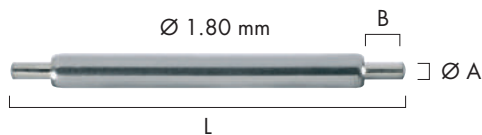

Barrette simple ; acier inoxydable.
 Regular spring bar ; stainless steel.
 Einfacher Federsteg ; Edelstahl.
 Pasador sencillo ; acero inoxidable.
 Ansa semplice ; acciaio inossidabile.
 Pino simples ; aço inoxidável.

100
pcs

MSA	L mm	Ø A x B mm	Kg
46.021-10.0	10	0.80 x 1.50	0.014
46.021-11.0	11	0.80 x 1.50	0.015
46.021-12.0	12	0.90 x 2.00	0.017
46.021-13.0	13	0.90 x 2.00	0.018
46.021-14.0	14	0.90 x 2.00	0.019
46.021-15.0	15	0.90 x 2.00	0.020
46.021-16.0	16	0.90 x 2.00	0.022
46.021-17.0	17	0.90 x 2.00	0.023

MSA	L mm	Ø A x B mm	Kg
46.021-18.0	18	0.90 x 2.00	0.023
46.021-19.0	19	0.90 x 2.00	0.024
46.021-20.0	20	0.90 x 2.00	0.025
46.021-21.0	21	0.90 x 2.00	0.026
46.021-22.0	22	0.90 x 2.00	0.027
46.021-23.0	23	0.90 x 2.00	0.028
46.021-24.0	24	0.90 x 2.00	0.029

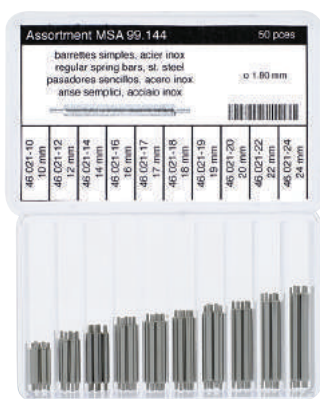

Ø 1.80 mm



Assortiment de barrettes simples ; acier inoxydable.
 Assortiment of regular spring bars ; stainless steel.
 Sortiment von einfache Federsteg ; Edelstahl.
 Surtido de pasadores sencillos ; acero inoxidable.
 Assortimento di anse semplici ; acciaio inossidabile.
 Sortido de pinos simples ; aço inoxidável.

MSA	Qt.	Kg
99.144	50x	0.038

Contenu - Contents - Inhalt - Contenido - Contenuto - Conteúdo :
10 modèles - models - Modelle - modelos - modelli - modelos
5x MSA46.021-10.0 /-12.0 /-14.0 /-16.0 /-17.0 /-18.0 /-19.0
/-20.0 /-22.0 /-24.0



Barrette simple ; acier inoxydable.
 Regular spring bar ; stainless steel.
 Einfacher Federsteg ; Edelstahl.
 Pasador sencillo ; acero inoxidable.
 Ansa semplice ; acciaio inossidabile.
 Pino simples ; aço inoxidável.

100
pcs

MSA	L mm	Ø A x B mm	Kg
46.022-10.0	10	0.80 x 1.50	0.019
46.022-11.0	11	0.80 x 1.50	0.020
46.022-12.0	12	0.90 x 2.00	0.021
46.022-13.0	13	0.90 x 2.00	0.022
46.022-14.0	14	0.90 x 2.00	0.023
46.022-15.0	15	0.90 x 2.00	0.024
46.022-16.0	16	0.90 x 2.00	0.025
46.022-17.0	17	0.90 x 2.00	0.026

MSA	L mm	Ø A x B mm	Kg
46.022-18.0	18	0.90 x 2.00	0.027
46.022-19.0	19	0.90 x 2.00	0.028
46.022-20.0	20	0.90 x 2.00	0.029
46.022-21.0	21	0.90 x 2.00	0.030
46.022-22.0	22	0.90 x 2.00	0.031
46.022-23.0	23	0.90 x 2.00	0.032
46.022-24.0	24	0.90 x 2.00	0.034



Ø 2.00 mm



Assortiment de barrettes simples ; acier inoxydable.
 Assortiment of regular spring bars ; stainless steel.
 Sortiment von einfache Federstege ; Edelstahl.
 Surtido de pasadores sencillos ; acero inoxidable.
 Assortimento di anse semplici ; acciaio inossidabile.
 Sortido de pinos simples ; aço inoxidável.

MSA	Qt.	Kg
99.194	60x	0.052

Contenu - Contents - Inhalt - Contenido - Contenuto - Conteúdo :
12 modèles - models - Modelle - modelos - modelli - modelos
5x MSA46.022-10.0 /-12.0 /-14.0 /-15.0 /-16.0 /-17.0 /-18.0
/-20.0 /-21.0 /-22.0 /-23.0 /-24.0

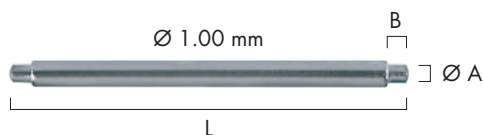

Barrette pour fermoir ; acier inoxydable.

Spring bar for clasp ; stainless steel.

Federsteg für Schliessen ; Edelstahl.

Pasador para cierre ; acero inoxidable.

Ansa per chiusura ; acciaio inossidabile.

Pino para fecho ; aço inoxidável.

100
pcs

MSA	L mm	Ø A x B mm	Kg
46.030-06	6	0.70 x 0.70	0.006
46.030-07	7	0.70 x 0.70	0.006
46.030-08	8	0.70 x 0.70	0.006
46.030-09	9	0.70 x 0.70	0.006
46.030-10	10	0.70 x 0.70	0.006
46.030-11	11	0.70 x 0.70	0.006
46.030-12	12	0.70 x 0.70	0.006
46.030-13	13	0.70 x 0.70	0.006

MSA	L mm	Ø A x B mm	Kg
46.030-14	14	0.70 x 0.70	0.006
46.030-15	15	0.70 x 0.70	0.006
46.030-16	16	0.70 x 0.70	0.006
46.030-17	17	0.70 x 0.70	0.006
46.030-18	18	0.70 x 0.70	0.006
46.030-19	19	0.70 x 0.70	0.006
46.030-20	20	0.70 x 0.70	0.006

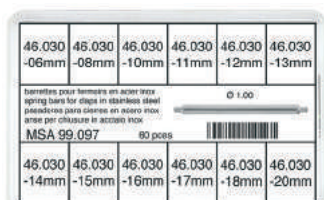

Ø 1.00 mm



Assortiment de barrettes pour fermoirs ; acier inoxydable.

Assortiment of spring bars for clasps ; stainless steel.

Sortiment von Federstege für Schliessen ; Edelstahl.

Surtido de pasadores para cierres ; acero inoxidable.

Assortimento di anse per chiusure ; acciaio inossidabile.

Sortido de pinos para fechos ; aço inoxidável.

MSA	Qt.	Kg
99.097	60x	0.028

Contenu - Contents - Inhalt - Contenido - Contenuto - Conteúdo :
12 modèles - models - Modelle - modelos - modelli - modelos
5x MSA46.030-06 /-08 /-10 /-11 /-12 /-13 /-14 /-15 /-16 /-17
/-18 /-20

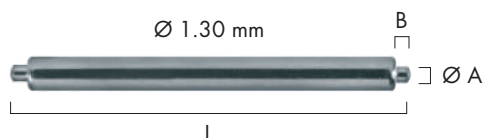

Barrette pour fermoir ; acier inoxydable.

Spring bar for clasp ; stainless steel.

Federsteg für Schliess ; Edelstahl.

Pasador para cierre ; acero inoxidable.

Ansa per chiusura ; acciaio inossidabile.

Pino para fecho ; aço inoxidável.

100
pcs

MSA	L mm	Ø A x B mm	Kg
46.700-06	6	0.80 x 1.20	0.010
46.700-07	7	0.80 x 1.20	0.010
46.700-08	8	0.80 x 1.20	0.010
46.700-09	9	0.80 x 1.20	0.010
46.700-10	10	0.80 x 1.20	0.010
46.700-11	11	0.80 x 1.20	0.010
46.700-12	12	0.80 x 1.20	0.010
46.700-13	13	0.80 x 1.20	0.010

MSA	L mm	Ø A x B mm	Kg
46.700-14	14	0.80 x 1.20	0.010
46.700-15	15	0.80 x 1.20	0.010
46.700-16	16	0.80 x 1.20	0.010
46.700-17	17	0.80 x 1.20	0.010
46.700-18	18	0.80 x 1.20	0.010
46.700-19	19	0.80 x 1.20	0.010
46.700-20	20	0.80 x 1.20	0.010

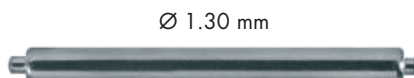

Assortiment de barrettes pour fermoirs ; acier inoxydable.

Assortment of spring bars for clasps ; stainless steel.

Sortiment von Federstege für Schliessen ; Edelstahl.

Surtido de pasadores para cierres ; acero inoxidable.

Assortimento di anse per chiusure ; acciaio inossidabile.

Sortido de pinos para fechos ; aço inoxidável.

MSA	Qt.	Kg
99.036	100x	0.038

Contenu - Contents - Inhalt - Contenido - Contenuto - Conteúdo :
10 modèles - models - Modelle - modelos - modelli - modelos
10x MSA46.700-06 /-08 /-09 /-10 /-12 /-14 /-16 /-17 /-18 /-20

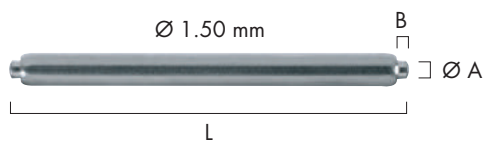

Barrette pour fermoir, mesure spéciale ; acier inoxydable.
 Spring bar for clasp, special size ; stainless steel.
 Federsteg für Schliessen, Sondermassnahm ; Edelstahl.
 Pasador para cierre, medida especial ; acero inoxidable.
 Ansa per chiusura, misura speciale ; acciaio inossidabile.
 Pino para fecho, medida especial ; aço inoxidável.

100
pcs

MSA	L mm	Ø A x B mm	Kg
46.040-10	10.90	0.80 x 0.60	0.017
46.040-12	12.90	0.80 x 0.60	0.017
46.040-14	14.90	0.80 x 0.60	0.017
46.040-15	15.90	0.80 x 0.60	0.017

MSA	L mm	Ø A x B mm	Kg
46.040-16	16.90	0.80 x 0.60	0.017
46.040-17	17.90	0.80 x 0.60	0.017
46.040-19	19.90	0.80 x 0.60	0.017



Ø 1.50 mm



Assortiment de barrettes pour fermoirs, mesures spéciales ; acier inoxydable.
 Assortment of spring bars for clasps, special sizes ; stainless steel.
 Sortiment von Federstegen für Schliessen, Sondermassnahmen ; Edelstahl.
 Surtido de pasadores para cierres, medidas especiales ; acero inoxidable.
 Assortimento di anse per chiusure, misure speciali ; acciaio inossidabile.
 Sortido de pinos para fechos, medidas especiais ; aço inoxidável.

MSA	Qt.	Kg
99.192	100x	0.044

Contenu - Contents - Inhalt - Contenido - Contenuto - Conteúdo :
7 modèles - models - Modelle - modelos - modelli - modelos
10x MSA46.040-10 /-14 /-15 /-17
20x MSA46.040-12 /-16 /-19



Barrette de sécurité pour fermoir ; acier inoxydable.

Flanged spring bar for clasp ; stainless steel.

Ansatz Federsteg für Schliess ; Edelstahl.

Pasador de seguridad para cierre ; acero inoxidable.

Ansa di sicurezza per chiusura ; acciaio inossidabile.

Pino de segurança para fecho ; aço inoxidável.

100
pcs

MSA	L mm	Ø A x B mm	Kg
46.230-09	9	0.70 x 0.75	0.010
46.230-10	10	0.70 x 0.75	0.010
46.230-11	11	0.70 x 0.75	0.010
46.230-12	12	0.70 x 0.75	0.010
46.230-13	13	0.70 x 0.75	0.010
46.230-14	14	0.70 x 0.75	0.010
46.230-15	15	0.70 x 0.75	0.010
46.230-16	16	0.70 x 0.75	0.010
46.230-17	17	0.70 x 0.75	0.010
46.230-18	18	0.70 x 0.75	0.010
46.230-19	19	0.70 x 0.75	0.010
46.230-20	20	0.70 x 0.75	0.010

10
pcs

MSA	L mm	Ø A x B mm	Kg
46.231-09	9	0.70 x 0.75	0.001
46.231-10	10	0.70 x 0.75	0.001
46.231-11	11	0.70 x 0.75	0.001
46.231-12	12	0.70 x 0.75	0.001
46.231-13	13	0.70 x 0.75	0.001
46.231-14	14	0.70 x 0.75	0.001
46.231-15	15	0.70 x 0.75	0.002
46.231-16	16	0.70 x 0.75	0.002
46.231-17	17	0.70 x 0.75	0.002
46.231-18	18	0.70 x 0.75	0.002
46.231-19	19	0.70 x 0.75	0.002
46.231-20	20	0.70 x 0.75	0.002

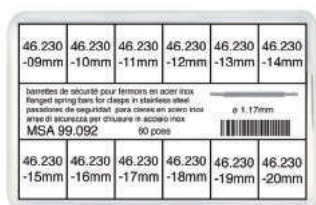

Ø 1.17 mm



Assortiment de barrettes de sécurité pour fermoirs ; acier inoxydable.

Assortment of flanged spring bars for clasps ; stainless steel.

Sortiment von Ansatz Federsteg für Schliessen ; Edelstahl.

Surtido de pasadores de seguridad para cierres ; acero inoxidable.

Assortimento di anse di sicurezza per chiusure ; acciaio inossidabile.

Sortido de pinos de segurança para fechos ; aço inoxidável.

Contenu - Contents - Inhalt - Contenido - Contenuto - Conteúdo :
12 modèles - models - Modelle - modelos - modelli - modelos
5x MSA46.230-09 /-10 /-11 /-12 /-13 /-14 /-15 /-16 /-17 /-18
/-19 /-20

MSA	Qt.	Kg
99.092	60x	0.030



Barrette de sécurité pour fermoir ; acier inoxydable.
 Flanged spring bar for clasp ; stainless steel.
 Ansatz Federsteg für Schliess ; Edelstahl.
 Pasador de seguridad para cierre ; acero inoxidable.
 Ansa di sicurezza per chiusura ; acciaio inossidabile.
 Pino de segurança para fecho ; aço inoxidável.

100
pcs

MSA	L mm	Ø A x B mm	Kg
46.750-08	8	0.90 x 0.60	0.012
46.750-09	9	0.90 x 0.60	0.012
46.750-10	10	0.90 x 0.60	0.012
46.750-11	11	0.90 x 0.60	0.012
46.750-12	12	0.90 x 0.60	0.012
46.750-13	13	0.90 x 0.60	0.012
46.750-14	14	0.90 x 0.60	0.012
46.750-15	15	0.90 x 0.60	0.012
46.750-16	16	0.90 x 0.60	0.012

MSA	L mm	Ø A x B mm	Kg
46.750-17	17	0.90 x 0.60	0.012
46.750-18	18	0.90 x 0.60	0.012
46.750-19	19	0.90 x 0.60	0.012
46.750-20	20	0.90 x 0.60	0.012
46.750-21	21	0.90 x 0.60	0.012
46.750-22	22	0.90 x 0.60	0.012
46.750-23	23	0.90 x 0.60	0.012
46.750-24	24	0.90 x 0.60	0.012

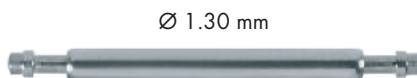

Assortiment de barrettes de sécurité pour fermoirs ; acier inoxydable.
 Assortment of flanged spring bars for clasps ; stainless steel.
 Sortiment von Ansatz Federstege für Schliessen ; Edelstahl.
 Sortido de pasadores de seguridad para cierres ; acero inoxidable.
 Assortimento di anse di sicurezza per chiusure ; acciaio inossidabile.
 Sortido de pinos de segurança para fechos ; aço inoxidável.

MSA	Qt.	Kg
99.098	60x	0.032

Contenu - Contents - Inhalt - Contenido - Contenuto - Conteúdo :
11 modèles - models - Modelle - modelos - modelli - modelos
5x MSA46.750-10 /-11 /-12 /-13 /-14 /-15 /-16 /-17 /-19 /-20
10x MSA46.750-18



Barrette de sécurité pour fermoir ; acier inoxydable.
 Flanged spring bar for clasp ; stainless steel.
 Ansatz Federsteg für Schliess ; Edelstahl.
 Pasador de seguridad para cierre ; acero inoxidable.
 Ansa di sicurezza per chiusura ; acciaio inossidabile.
 Pino de segurança para fecho ; aço inoxidável.

100
pcs

MSA	L mm	Ø A x B mm	Kg
46.751-10	10	0.90 x 0.60	0.010
46.751-11	11	0.90 x 0.60	0.012
46.751-12	12	0.90 x 0.60	0.012
46.751-13	13	0.90 x 0.60	0.013
46.751-14	14	0.90 x 0.60	0.014
46.751-15	15	0.90 x 0.60	0.015

MSA	L mm	Ø A x B mm	Kg
46.751-16	16	0.90 x 0.60	0.016
46.751-17	17	0.90 x 0.60	0.017
46.751-18	18	0.90 x 0.60	0.017
46.751-19	19	0.90 x 0.60	0.018
46.751-20	20	0.90 x 0.60	0.019



Ø 1.50 mm



Assortiment de barrettes de sécurité pour fermoirs ; acier inoxydable.
 Assortment of flanged spring bars for clasps ; stainless steel.
 Sortiment von Ansatz Federsteg für Schliessen ; Edelstahl.
 Surtido de pasadores de seguridad para cierres ; acero inoxidable.
 Assortimento di anse di sicurezza per chiusure ; acciaio inossidabile.
 Sortido de pinos de segurança para fechos ; aço inoxidável.

MSA	Qt.	Kg
99.152	60x	0.033

Contenu - Contents - Inhalt - Contenido - Contenuto - Conteúdo :
11 modèles - models - Modelle - modelos - modelli - modelos
5x MSA46.751-10 /-11 /-12 /-13 /-14 /-15 /-16 /-17 /-19 /-20
10x MSA46.751-18

10
pcs



MSA	L mm	Ø A x B mm	Kg
46.051-13	13	0.88 x 1.60	0.003

Barrette spéciale forte ; acier inoxydable.
Special strong spring bar ; stainless steel.
 Spezieller starker Federsteg ; Edelstahl.
Pasador especial fuerte ; acero inoxidable.
 Ansa speciale forte ; acciaio inossidabile.
Pino especial forte ; aço inoxidável.

10
pcs



MSA	L mm	Ø A x B mm	Kg
46.050-20	20	1.20 x 2.80	0.004

Barrette spéciale forte ; acier inoxydable.
Special strong spring bar ; stainless steel.
 Spezieller starker Federsteg ; Edelstahl.
Pasador especial fuerte ; acero inoxidable.
 Ansa speciale forte ; acciaio inossidabile.
Pino especial forte ; aço inoxidável.

10
pcs

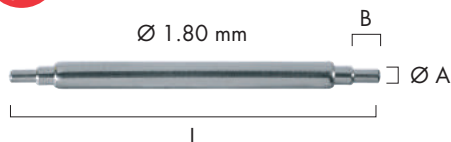

MSA	L mm	Ø A x B mm	Kg
46.053-13	13	0.88 x 1.65	0.003
46.053-17	17	0.88 x 2.00	0.003
46.053-19	19	0.88 x 2.00	0.003
46.053-20	20	0.88 x 2.00	0.003

Barrette télescopique spéciale forte ; acier inoxydable.
Telescopic special strong spring bar ; stainless steel.
 Teleskopischer spezieller starker Federsteg ; Edelstahl.
Pasador telescópico especial fuerte ; acero inoxidable.
 Ansa telescopica speciale forte ; acciaio inossidabile.
Pino telescópico especial forte ; aço inoxidável.

10
pcs

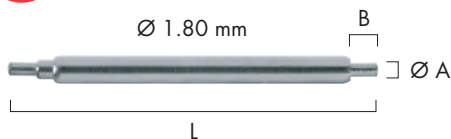

MSA	L mm	Ø A x B mm	Kg
46.054-20	20	0.88 x 2.00	0.003

Barrette spéciale forte, 1 côté télescopique ; acier inoxydable.
Special strong spring bar, 1 telescopic side ; stainless steel.
 Spezieller starker Federsteg, 1 teleskopischer Seite ; Edelstahl.
Pasador especial fuerte, 1 lado telescópico ; acero inoxidable.
 Ansa speciale forte, 1 lato telescopico ; acciaio inossidabile.
Pino especial forte, 1 lado telescópico ; aço inoxidável.

10
pcs

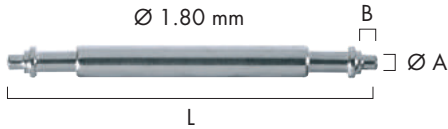

MSA	L mm	Ø A x B mm	Kg
46.052-13	13	0.88 x 1.00	0.003
46.052-14	14	0.88 x 1.00	0.003
46.052-15	15	0.88 x 1.00	0.003
46.052-16	16	0.88 x 1.00	0.003
46.052-17	17	0.88 x 1.00	0.003
46.052-18	18	0.88 x 1.00	0.003
46.052-19	19	0.88 x 1.00	0.003
46.052-20	20	0.88 x 1.00	0.003
46.052-21	21	0.88 x 1.00	0.003
46.052-22	22	0.88 x 1.00	0.003

Barrette de sécurité spéciale forte ; acier inoxydable.

Flanged special strong spring bar ; stainless steel.

Doppel-Ansatz spezieller starker Federsteg ; Edelstahl.

Pasador de seguridad especial fuerte ; acero inoxidable.

Ansa di sicurezza speciale forte ; acciaio inossidabile.

Pino de segurança especial forte ; aço inoxidável.

10
pcs

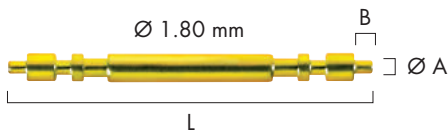

MSA	L mm	Ø A x B mm	Kg
46.056-20	20	0.88 x 1.00	0.004

Barrette double sécurité spéciale forte, dorée ; acier inoxydable.

Double flanged special strong spring bar, gilt ; stainless steel.

Doppel-Ansatz spezieller starker Federsteg, vergoldet ; Edelstahl.

Pasador doble seguridad especial fuerte, dorado ; acero inoxidable.

Ansa doppia sicurezza speciale forte, dorata ; acciaio inossidabile.

Pino dupla segurança especial forte, dourado ; aço inoxidável.

10
pcs

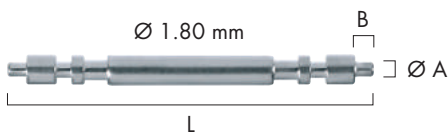

MSA	L mm	Ø A x B mm	Kg
46.055-20	20	0.88 x 1.00	0.004

Barrette double sécurité spéciale forte ; acier inoxydable.

Double flanged special strong spring bar ; stainless steel.

Doppel-Ansatz spezieller starker Federsteg ; Edelstahl.

Pasador doble seguridad especial fuerte ; acero inoxidable.

Ansa doppia sicurezza speciale forte ; acciaio inossidabile.

Pino dupla segurança especial forte ; aço inoxidável.

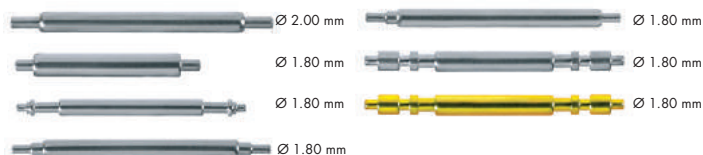

Assortiment de barrettes spéciales fortes, couleur acier et dorées ; acier inoxydable.
 Assortment of special strong spring bars, steel colour and gilt ; stainless steel.
 Sortiment von spezielle starke Federstege, Stahlfarbe und vergoldene ; Edelstahl.
 Surtido de pasadores especiales fuertes, color acero y dorados ; acero inoxidable.
 Assortimento di anse speciali forti, colore acciaio e dorate ; acciaio inossidabile.
 Sortido de pinos especiais fortes, cor aço e dourados ; aço inoxidável.

Contenu - Contents - Inhalt - Contenido - Contenuto - Conteúdo :
10 modèles - models - Modelle - modelos - modelli - modelos
4x MSA46.050-20 /.051-13 /.052-13 /.052-17 /.052-19 /.052-
20 /.053-19 /.054-20 /.055-20 /.056-20

MSA	Qt.	Kg
99.120	40x	0.038

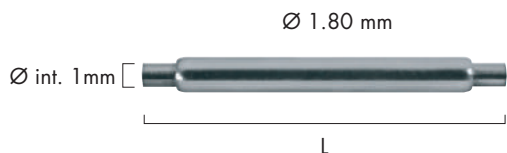

Barrette femelle ; maillechort.
 Female bar ; nickel silver.
 Weiblicher Steg ; Neusilber.
 Pasador hembra ; alpaca.
 Ansa femmina ; argenteone.
 Pino fêmeo ; níquel prateado.

100
pcs

MSA	L mm	Kg
46.400-07.0	7	0.020
46.400-08.0	8	0.020
46.400-09.0	9	0.020
46.400-10.0	10	0.020
46.400-11.0	11	0.020
46.400-12.0	12	0.020
46.400-13.0	13	0.020
46.400-14.0	14	0.020
46.400-15.0	15	0.020

MSA	L mm	Kg
46.400-16.0	16	0.020
46.400-17.0	17	0.020
46.400-18.0	18	0.020
46.400-19.0	19	0.020
46.400-20.0	20	0.020
46.400-21.0	21	0.020
46.400-22.0	22	0.020
46.400-23.0	23	0.020
46.400-24.0	24	0.020

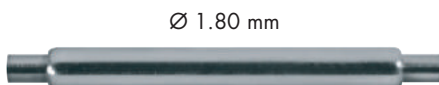
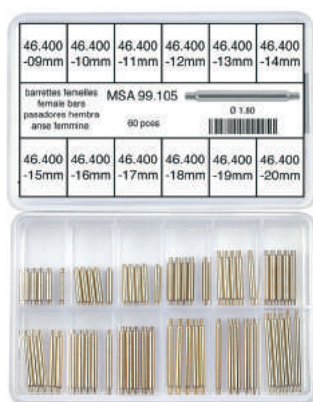

Assortiment de barrettes femelles ; maillechort.
 Assortiment of female bars ; nickel silver.
 Sortiment von weibliche Stege ; Neusilber.
 Surtido de pasadores hembra ; alpaca.
 Assortimento di anse femmina ; argenteone.
 Sortido de pinos fêmeos ; níquel prateado.

MSA	Qt.	Kg
99.105	60x	0.037

Contenu - Contents - Inhalt - Contenido - Contenuto - Conteúdo :
12 modèles - models - Modelle - modelos - modelli - modelos
5x MSA46.400-09 /-10 /-11 /-12 /-13 /-14 /-15 /-16 /-17 /-18
/-19 /-20

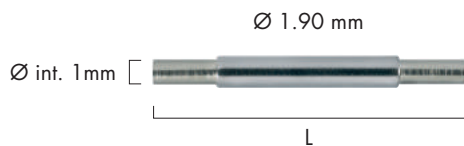

Barrette femelle universelle télescopique ; maillechort.
 Female telescopic universal bar ; nickel silver.
 Weiblicher teleskopischer universeller Steg ; Neusilber.
 Pasador hembra universal telescópico ; alpaca.
 Ansa femmina universale telescopica ; argentone.
 Pino fêmeo universal telescópico ; níquel prateado.

100
pcs

MSA	L mm	Kg
46.450-0812	08-12	0.015
46.450-1015	10-15	0.015
46.450-1218	12-18	0.016

MSA	L mm	Kg
46.450-1522	15-22	0.016
46.450-1824	18-24	0.018

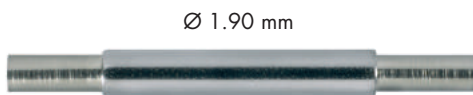
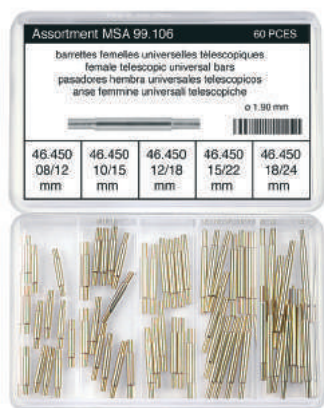

Assortiment de barrettes femelles universelles télescopiques ; maillechort.
 Assortment of female telescopic universal bars ; nickel silver.
 Sortiment von weibliche teleskopische universelle Stege ; Neusilber.
 Surtido de pasadores hembra universales telescópicos ; alpaca.
 Assortimento di anse femmina universali telescopiche ; argentone.
 Sortido de pinos fêmeos universais telescópicos ; níquel prateado.

MSA	Qt.	Kg
99.106	60x	0.033

Contenu - Contents - Inhalt - Contenido - Contenuto - Conteúdo :
5 modèles - models - Modelle - modelos - modelli - modelos
12x MSA46.450-0812 /-1015 /-1218 /-1522 /-1824

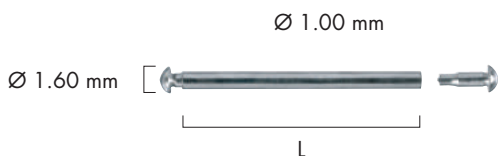

Barrette à pression ; acier inoxydable.
 Press-in bar ; stainless steel.
 Drucksteg ; Edelstahl.
 Pasador de presión ; acero inoxidable.
 Ansa a pressione ; acciaio inossidabile.
 Pino de pressão ; aço inoxidável.

10
pcs

MSA	L mm	Kg
46.380-10	10	0.002
46.380-12	12	0.002
46.380-14	14	0.002
46.380-15	15	0.002
46.380-16	16	0.002
46.380-17	17	0.002
46.380-18	18	0.002
46.380-19	19	0.002
46.380-20	20	0.002
46.380-21	21	0.002

MSA	L mm	Kg
46.380-22	22	0.002
46.380-23	23	0.002
46.380-24	24	0.002
46.380-25	25	0.002
46.380-26	26	0.002
46.380-27	27	0.002
46.380-28	28	0.002
46.380-29	29	0.002
46.380-30	30	0.002

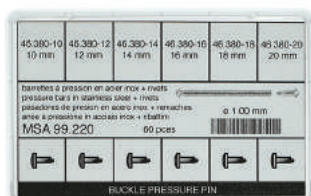

Ø 1.00 mm



Assortiment de barrettes à pression ; acier inoxydable.
 Assortment of press-in bars ; stainless steel.
 Sortiment von Druckstegen ; Edelstahl.
 Surtido de pasadores de presión ; acero inoxidable.
 Assortimento di anse a pressione ; acciaio inossidabile.
 Sortido de pinos de pressão ; aço inoxidável.

MSA	Qt.	Kg
99.220	60x	0.029

Contenu - Contents - Inhalt - Contenido - Contenuto - Conteúdo :
6 modèles - models - Modelle - modelos - modelli - modelos
10x MSA46.380-10 /-12 /-14 /-16 /-18 /-20

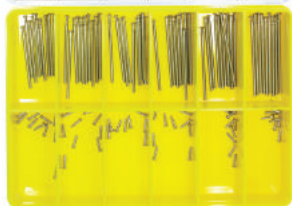
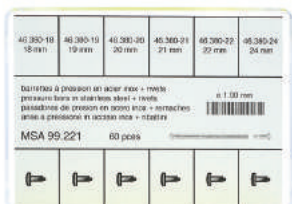

Ø 1.00 mm



Assortiment de barrettes à pression ; acier inoxydable.
Assortiment of press-in bars ; stainless steel.
 Sortiment von Druckstege ; Edelstahl.
Surtido de pasadores de presión ; acero inoxidable.
 Assortimento di anse a pressione ; acciaio inossidabile.
Sortido de pinos de pressão ; aço inoxidável.

MSA	Qt.	Kg
99.221	60x	0.042

Contenu - Contents - Inhalt - Contenido - Contenuto - Conteúdo :
6 modèles - models - Modelle - modelos - modelli - modelos
10x MSA46.380-18 /-19 /-20 /-21 /-22 /-24



Ø 1.00 mm



Assortiment de barrettes à pression ; acier inoxydable.
Assortiment of press-in bars ; stainless steel.
 Sortiment von Druckstege ; Edelstahl.
Surtido de pasadores de presión ; acero inoxidable.
 Assortimento di anse a pressione ; acciaio inossidabile.
Sortido de pinos de pressão ; aço inoxidável.

MSA	Qt.	Kg
99.222	100x	0.037

Contenu - Contents - Inhalt - Contenido - Contenuto - Conteúdo :
10 modèles - models - Modelle - modelos - modelli - modelos
10x MSA46.380-21 /-22 /-23 /-24 /-25 /-26 /-27 /-28 /-29 /-30

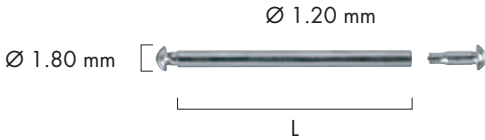

Barrette à pression ; acier inoxydable.

Press-in bar ; stainless steel.

Drucksteg ; Edelstahl.

Pasador de presión ; acero inoxidable.

Ansa a pressione ; acciaio inossidabile.

Pino de pressão ; aço inoxidável.

10
pcs

MSA	L mm	Kg
46.390-10	10	0.002
46.390-12	12	0.002
46.390-14	14	0.002
46.390-15	15	0.002
46.390-16	16	0.002
46.390-17	17	0.002
46.390-18	18	0.002
46.390-19	19	0.002
46.390-20	20	0.002
46.390-21	21	0.002

MSA	L mm	Kg
46.390-22	22	0.002
46.390-23	23	0.002
46.390-24	24	0.002
46.390-25	25	0.002
46.390-26	26	0.002
46.390-27	27	0.002
46.390-28	28	0.002
46.390-29	29	0.002
46.390-30	30	0.002



Assortiment de barrettes à pression ; acier inoxydable.

Assortment of press-in bars ; stainless steel.

Sortiment von Drucksteg ; Edelstahl.

Surtido de pasadores de presión ; acero inoxidable.

Assortimento di anse a pressione ; acciaio inossidabile.

Sortido de pinos de pressão ; aço inoxidável.

MSA	Qt.	Kg
99.110	60x	0.037

Contenu - Contents - Inhalt - Contenido - Contenuto - Conteúdo :
6 modèles - models - Modelle - modelos - modelli - modelos
10x MSA46.390-10 /-12 /-14 /-16 /-18 /-20



MSA	Qt.	Kg
99.190	60x	0.035

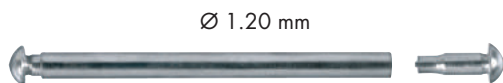

Assortiment de barrettes à pression ; acier inoxydable.

Assortiment of press-in bars ; stainless steel.

Sortiment von Druckstege ; Edelstahl.

Surtido de pasadores de presión ; acero inoxidable.

Assortimento di anse a pressione ; acciaio inossidabile.

Sortido de pinos de pressão ; aço inoxidável.

Contenu - Contents - Inhalt - Contenido - Contenuto - Conteúdo :
6 modèles - models - Modelle - modelos - modelli - modelos
10x MSA46.390-18 /-19 /-20 /-21 /-22 /-24



MSA	Qt.	Kg
99.191	100x	0.040

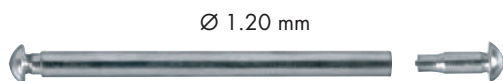

Assortiment de barrettes à pression ; acier inoxydable.

Assortiment of press-in bars ; stainless steel.

Sortiment von Druckstege ; Edelstahl.

Surtido de pasadores de presión ; acero inoxidable.

Assortimento di anse a pressione ; acciaio inossidabile.

Sortido de pinos de pressão ; aço inoxidável.

Contenu - Contents - Inhalt - Contenido - Contenuto - Conteúdo :
10 modèles - models - Modelle - modelos - modelli - modelos
10x MSA46.390-21 /-22 /-23 /-24 /-25 /-26 /-27 /-28 /-29 /-30

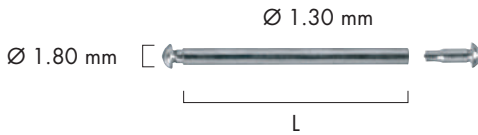

Barrette à pression ; acier inoxydable.
 Press-in bar ; stainless steel.
 Drucksteg ; Edelstahl.
 Pasador de presión ; acero inoxidable.
 Ansa a pressione ; acciaio inossidabile.
 Pino de pressão ; aço inoxidável.

10
pcs

MSA	L mm	Kg
46.370-18	18	0.002
46.370-20	20	0.002
46.370-22	22	0.002
46.370-24	24	0.002
46.370-26	26	0.002
46.370-28	28	0.002

MSA	L mm	Kg
46.370-30	30	0.002
46.370-31	31	0.002
46.370-32	32	0.002
46.370-33	33	0.002
46.370-34	34	0.002
46.370-35	35	0.002



Assortiment de barrettes à pression ; acier inoxydable.
 Assortment of press-in bars ; stainless steel.
 Sortiment von Druckstegen ; Edelstahl.
 Surtido de pasadores de presión ; acero inoxidable.
 Assortimento di anse a pressione ; acciaio inossidabile.
 Sortido de pinos de pressão ; aço inoxidável.

MSA	Qt.	Kg
99.225	100x	0.042

Contenu - Contents - Inhalt - Contenido - Contenuto - Conteúdo :
10 modèles - models - Modelle - modelos - modelli - modelos
10x MSA46.370-18 /-20 /-22 /-24 /-26 /-28 /-30 /-32 /-34 /-35

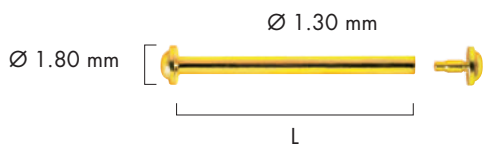

Barrette à pression, dorée ; acier inoxydable.
 Press-in bar, gilt ; stainless steel.
 Drucksteg, vergoldet ; Edelstahl.
 Pasador de presión, dorado ; acero inoxidable.
 Ansa a pressione, dorata ; acciaio inossidabile.
 Pino de pressão, dourado ; aço inoxidável.

100
pcs

MSA	L mm	Kg
46.805-12	12	0.023
46.805-14	14	0.023
46.805-16	16	0.023

MSA	L mm	Kg
46.805-18	18	0.023
46.805-20	20	0.023

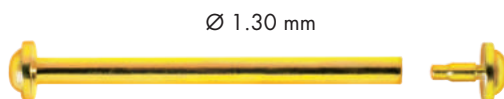

Assortiment de barrettes à pression, dorées ; acier inoxydable.
 Assortiment of press-in bars, gilt ; stainless steel.
 Sortiment von Druckstegen, vergoldet ; Edelstahl.
 Surtido de pasadores de presión, dorados ; acero inoxidable.
 Assortimento di anse a pressione, dorate ; acciaio inossidabile.
 Sortido de pinos de pressão, dourados ; aço inoxidável.

MSA	Qt.	Kg
99.057	60x	0.038

Contenu - Contents - Inhalt - Contenido - Contenuto - Conteúdo :
5 modèles - models - Modelle - modelos - modelli - modelos
10x MSA46.805-12 /-14 /-16 /-20
20x MSA46.805-18

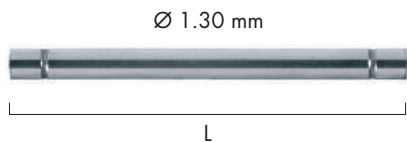

Tube pour barrettes à pression ; acier inoxydable.
 Tube for press-in bars ; stainless steel.
 Rohr für Druckstege ; Edelstahl.
 Tubo para pasadores de presión ; acero inoxidable.
 Tubo per anse a pressione ; acciaio inossidabile.
 Tubo para pinos de pressão ; aço inoxidável.

MSA	L mm	Kg
46.910-10	10	0.001
46.910-12	12	0.001
46.910-14	14	0.001
46.910-15	15	0.001
46.910-16	16	0.001

MSA	L mm	Kg
46.910-17	17	0.001
46.910-18	18	0.001
46.910-20	20	0.001
46.910-21	21	0.001



Rivet pour barrettes à pression ; laiton plaqué or 2N18 1 µ et laiton palladium 1 µ.
 Rivet for press-in bars ; brass gold-plated 2N18 1 µ and palladium brass 1 µ.
 Niete für Druckstege ; Messing vergoldet 2N18 1 µ und Messing Palladium 1 µ.
 Remache para pasadores de presión ; latón dorado 2N18 1 µ y latón paladio 1 µ.
 Ribattino per anse a pressione ; ottone placcato oro 2N18 1 µ e ottone palladio 1 µ.
 Rebite para pinos de pressão ; latão banhado a ouro 2N18 1 µ e latão paládio 1 µ.

MSA	Laiton plaqué/Brass gold-plated	Dimension/Size mm	MSA	Laiton palladium/Palladium brass
46.911		Ø 2.50x1.15 / M 1.00 / L 4.80	46.912	
46.913		Ø 3.00x1.15 / M 1.00 / L 4.80	46.914	

Kg 0.001 1/1

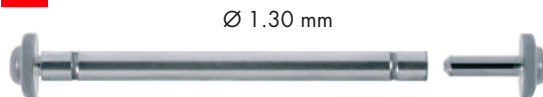

Assortiment de barrettes à pression ; acier inoxydable.
 Assortment of press-in bars ; stainless steel.
 Sortiment von Druckstege ; Edelstahl.
 Surtido de pasadores de presión ; acero inoxidable.
 Assortimento di anse a pressione ; acciaio inossidabile.
 Sortido de pinos de pressão ; aço inoxidável.

MSA	Qt.	Kg
99.053	16x + 32x	0.073

Contenu - Contents - Inhalt - Contenido - Contenuto - Conteúdo :
8+4 modèles - models - Modelle - modelos - modelli - modelos
2x MSA46.910-10 /-12 /-14 /-15 /-16 /-17 /-18 /-20
8x MSA46.911 /.912 /.913 /.914

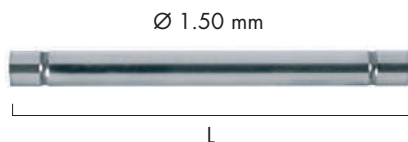

Tube pour barrettes à pression ; acier inoxydable.

Tube for press-in bars ; stainless steel.

Rohr für Druckfederstege ; Edelstahl.

Tubo para pasadores de presión ; acero inoxidable.

Tubo per anse a pressione ; acciaio inossidabile.

Tubo para pinos de pressão ; aço inoxidável.

MSA	Longueur/Length mm	Kg
46.920-10	10	0.001
46.920-12	12	0.001
46.920-14	14	0.001
46.920-15	15	0.001

MSA	Longueur/Length mm	Kg
46.920-16	16	0.001
46.920-17	17	0.001
46.920-18	18	0.001
46.920-20	20	0.001



Rivet pour barrettes à pression ; laiton MS58 et laiton palladium 1 µ.

Rivet for press-in bars ; brass MS58 and palladium brass 1 µ.

Niete für Druckfederstege ; Messing MS58 und Messing Palladium 1 µ.

Remache para pasadores de presión ; latón MS58 y latón paladio 1 µ.

Ribattino per anse a pressione ; ottone MS58 e ottone palladio 1 µ.

Rebite para pinos de pressão ; latão MS58 e latão paládio 1 µ.

MSA	Laiton plaqué/Brass gold-plated	Dimension/Size mm	MSA	Laiton palladium/ Palladium brass
46.921		Ø 3.00x1.15 / M 1.00 / L 5.00	46.922	
46.923		Ø 3.50x1.15 / M 1.00 / L 5.20	46.924	

Kg 0.001 1/1

BARRETTES À PRESSION | PRESS-IN BARS |
 DRUCKSTEGE | PASADORES DE PRESIÓN |
 ANSE A PRESSIONE | PINOS DE PRESSÃO |



MSA	Qt.	Kg
99.054	16x + 32x	0.073



Ø 1.50 mm



Assortiment de barrettes à pression ; acier inoxydable.

Assortiment of press-in bars ; stainless steel.

Sortiment von Druckstege ; Edelstahl.

Sortido de pasadores de presión ; acero inoxidable.

Assortimento di anse a pressione ; acciaio inossidabile.

Sortido de pinos de pressão ; aço inoxidável.

Contenu - Contents - Inhalt - Contenido - Contenuto - Conteúdo :
8+4 modèles - models - Modelle - modelos - modelli - modelos
2x MSA46.920-10 /-12 /-14 /-15 /-16 /-17 /-18 /-20
8x MSA46.921 /.922 /.923 /.924

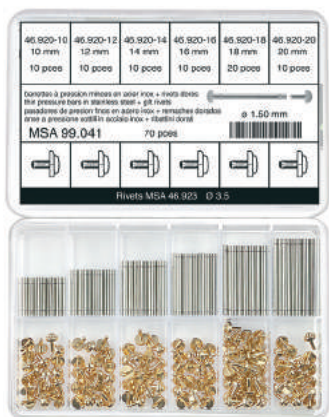

MSA	Qt.	Kg
99.041	70x + 140x	0.235



Ø 1.50 mm



Assortiment de barrettes à pression ; acier inoxydable.

Assortiment of press-in bars ; stainless steel.

Sortiment von Druckstege ; Edelstahl.

Sortido de pasadores de presión ; acero inoxidable.

Assortimento di anse a pressione ; acciaio inossidabile.

Sortido de pinos de pressão ; aço inoxidável.

Contenu - Contents - Inhalt - Contenido - Contenuto - Conteúdo :
6+1 modèles - models - Modelle - modelos - modelli - modelos
10x MSA46.920-10 /-12 /-14 /-16 /-20
20x MSA46.920-18
140x MSA46.923

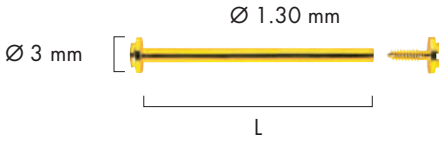

Barrette à vis dorée ; laiton.
 Gilded screw-on bar ; brass.
 Vergoldenem Schraubsteg ; Messing.
 Pasador de rosca dorado ; latón.
 Ansa a vite dorata ; ottone.
 Pino de rosca dourado ; latão.

10
pcs

MSA	Longueur/Length mm	Kg
46.800-12	12	0.003
46.800-14	14	0.003
46.800-16	16	0.003

MSA	Longueur/Length mm	Kg
46.800-18	18	0.003
46.800-20	20	0.003

100
pcs



Vis pour barrettes à vis dorées ; laiton.
 Screw for gilded screw-on bars ; brass.
 Schraube für vergoldene Schraubsteg ; Messing.
 Tornillo para pasadores de rosca dorados ; latón.
 Vite per anse a vite dorate ; ottone.
 Parafuso para pinos de rosca dourados ; latão.

MSA	Kg
46.800-V	0.006

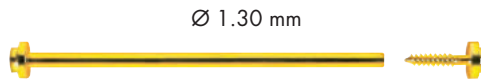

Assortiment de barrettes à vis dorées ; laiton.
 Assortment of gilded screw-on bars ; brass.
 Sortiment von vergoldene Schraubsteg ; Messing.
 Surtido de pasadores de rosca dorados ; latón.
 Assortimento di anse a vite dorate ; ottone.
 Sortido de pinos de rosca dourados ; latão.

MSA	Qt.	Kg
99.002	60x	0.043

Contenu - Contents - Inhalt - Contenido - Contenuto - Conteúdo :
5 modèles - models - Modelle - modelos - modelli - modelos
10x MSA46.800-12 /-14 /-16 /-20
20x MSA46.800-18

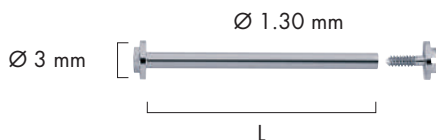

Barrette à vis chromée ; laiton.
 Chromed screw-on bar ; brass.
 Verchromtem Schraubsteg ; Messing.
 Pasador de rosca cromado ; latón.
 Ansa a vite cromata ; ottone.
 Pino de rosca cromado ; latão.

10
pcs

MSA	Longueur/Length mm	Kg
46.801-12	12	0.003
46.801-14	14	0.003
46.801-16	16	0.003

MSA	Longueur/Length mm	Kg
46.801-18	18	0.003
46.801-20	20	0.003

100
pcs



Vis pour barrettes à vis chromées ; laiton.
 Screw for chromed screw-on bars ; brass.
 Schraube für verchromte Schraubsteg ; Messing.
 Tornillo para pasadores de rosca cromados ; latón.
 Vite per anse a vite cromate ; ottone.
 Parafuso para pinos de rosca cromados ; latão.

MSA	Kg
46.801-V	0.005



Assortiment de barrettes à vis chromées ; laiton.
 Assortment of chromed screw-on bars ; brass.
 Sortiment von verchromte Schraubsteg ; Messing.
 Surtido de pasadores de rosca cromados ; latón.
 Assortimento di anse a vite cromate ; ottone.
 Sortido de pinos de rosca cromados ; latão.

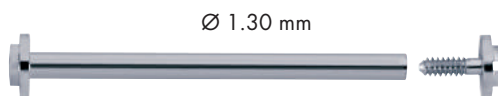

MSA	Qt.	Kg
99.108	60x	0.043

Contenu - Contents - Inhalt - Contenido - Contenuto - Conteúdo :
5 modèles - models - Modelle - modelos - modelli - modelos
10x MSA46.801-12 /-14 /-16 /-20
20x MSA46.801-18

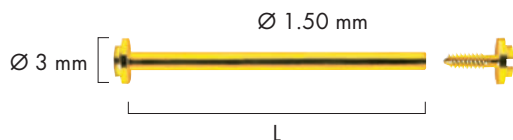

Barrette à vis dorée ; laiton.
 Gilded screw-on bar ; brass.
 Vergoldenem Schraubsteg ; Messing.
 Pasador de rosca dorado ; latón.
 Ansa a vite dorata ; ottone.
 Pino de rosca dourado ; latão.

10
pcs

MSA	Longueur/Length mm	Kg
46.802-12	12	0.003
46.802-14	14	0.003
46.802-16	16	0.004

MSA	Longueur/Length mm	Kg
46.802-18	18	0.004
46.802-20	20	0.004



Assortiment de barrettes à vis dorées ; laiton.
 Assortment of gilded screw-on bars ; brass.
 Sortiment von vergoldene Schraubsteg ; Messing.
 Surtido de pasadores de rosca dorados ; latón.
 Assortimento di anse a vite dorate ; ottone.
 Sortido de pinos de rosca dourados ; latão.

MSA	Qt.	Kg
99.217	60x	0.043

Contenu - Contents - Inhalt - Contenido - Contenuto - Conteúdo :
5 modèles - models - Modelle - modelos - modelli - modelos
10x MSA46.802-12 /-14 /-16 /-20
20x MSA46.802-18

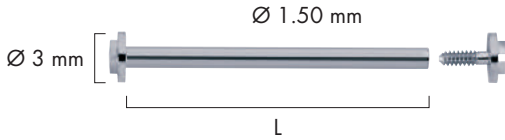

Barrette à vis chromée ; laiton.
 Chromed screw-on bar ; brass.
 Verchromtem Schraubsteg ; Messing.
 Pasador de rosca cromado ; latón.
 Ansa a vite cromata ; ottone.
 Pino de rosca cromado ; latão.

10
pcs

MSA	Longueur/Length mm	Kg
46.803-12	12	0.003
46.803-14	14	0.003
46.803-16	16	0.004

MSA	Longueur/Length mm	Kg
46.803-18	18	0.004
46.803-20	20	0.004

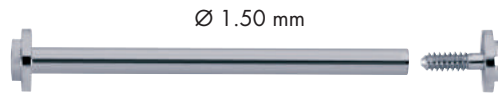

Assortiment de barrettes à vis chromées ; laiton.
 Assortiment of chromed screw-on bars ; brass.
 Sortiment von verchromte Schraubstege ; Messing.
 Surtido de pasadores de rosca cromados ; latón.
 Assortimento di anse a vite cromate ; ottone.
 Sortido de pinos de rosca cromados ; latão.

MSA	Qt.	Kg
99.216	60x	0.043

Contenu - Contents - Inhalt - Contenido - Contenuto - Conteúdo :
5 modèles - models - Modelle - modelos - modelli - modelos
10x MSA46.803-12 /-14 /-16 /-20
20x MSA46.803-18



Ø 1.30 mm



Tube pour barrettes à vis ; maillechort.
 Tube for screw-on bars ; nickel silver.
 Rohr für Schraubstege ; Neusilber.
 Tubo para pasadores de rosca ; alpaca.
 Tubo per anse a vite ; argentone.
 Tubo para pinos de rosca ; níquel prateado.

MSA	Longueur/Length mm	Kg
46.810-10	10	0.001
46.810-12	12	0.001
46.810-14	14	0.001
46.810-15	15	0.001

MSA	Longueur/Length mm	Kg
46.810-16	16	0.001
46.810-17	17	0.001
46.810-18	18	0.001
46.810-20	20	0.001



Vis pour barrettes à vis ; laiton plaqué or 2N18 1 µ et laiton palladium 1 µ.
 Screw for screw-on bars ; brass gold-plated 2N18 1 µ and palladium brass 1 µ.
 Schraube für Schraubstege ; Messing vergoldet 2N18 1 µ und Messing Palladium 1 µ.
 Tornillo para pasadores de rosca ; latón dorado 2N18 1 µ y latón paladio 1 µ.
 Vite per anse a vite ; ottone placcato oro 2N18 1 µ e ottone palladio 1 µ.
 Parafuso para pinos de rosca ; latão banhado a ouro 2N18 1 µ e latão paládio 1 µ.

MSA	Laiton plaqué/Brass gold-plated	Dimension/Size mm	MSA	Laiton palladium/ Palladium brass
46.811		Ø 3.00x1.15 / M 0.80 / L 3.60	46.812	
46.813		Ø 3.50x1.15 / M 0.80 / L 3.60	46.814	

Kg 0.001 1/1

46.810 -10mm	46.810 -12mm	46.810 -14mm	46.810 -15mm	46.811 Ø 3.8 mm Gold pl.	46.812 Ø 3.0 mm Palladium
16 barrettes à vis + 32 vis 16 screw-on bars + 32 screws 16 pasadores rosca + 32 tornillos 16 anse a vite + 32 vite MSA 99.055 48 pcs					
46.810 -16mm	46.810 -17mm	46.810 -18mm	46.810 -20mm	46.813 Ø 3.5 mm Gold pl.	46.814 Ø 3.5 mm Palladium



Ø 1.30 mm

Assortiment de barrettes à vis ; maillechort.

Assortiment of screw-on bars ; nickel silver.

Sortiment von Schraubstege ; Neusilber.

Sortido de pasadores de rosca ; alpaca.

Assortimento di anse a vite ; argenteone.

Sortido de pinos de rosca ; níquel plateado.

Contenu - Contents - Inhalt - Contenido - Contenuto - Conteúdo :
8+4 modèles - models - Modelle - modelos - modelli - modelos
2x MSA46.810-10 /-12 /-14 /-15 /-16 /-17 /-18 /-20
8x MSA46.811 /.812 /.813 /.814

MSA	Qt.	Kg
99.055	16x + 32x	0.073

46.810 -10mm	46.810 -12mm	46.810 -14mm	46.810 -15mm	46.811 Ø 3.8 mm Gold pl.	46.812 Ø 3.0 mm Palladium
80 barrettes à vis nitros + 160 vis 80 files screw-on bars + 160 screws 80 pasadores rosca + 160 tornillos 80 anse a vite + 160 vite MSA 99.059 240 pcs					
46.810 -16mm	46.810 -17mm	46.810 -18mm	46.810 -20mm	46.813 Ø 3.5 mm Gold pl.	46.814 Ø 3.5 mm Palladium



Ø 1.30 mm

Assortiment de barrettes à vis ; maillechort.

Assortiment of screw-on bars ; nickel silver.

Sortiment von Schraubstege ; Neusilber.

Sortido de pasadores de rosca ; alpaca.

Assortimento di anse a vite ; argenteone.

Sortido de pinos de rosca ; níquel plateado.

Contenu - Contents - Inhalt - Contenido - Contenuto - Conteúdo :
8+4 modèles - models - Modelle - modelos - modelli - modelos
10x MSA46.810-10 /-12 /-14 /-15 /-16 /-17 /-18 /-20
40x MSA46.811 /.812 /.813 /.814

MSA	Qt.	Kg
99.059	80x + 160x	0.265



Tube pour barrettes à vis ; maillechort.
 Tube for screw-on bars ; nickel silver.
 Rohr für Schraubstege ; Neusilber.
 Tubo para pasadores de rosca ; alpaca.
 Tubo per anse a vite ; argentone.
 Tubo para pinos de rosca ; níquel prateado.

MSA	Longueur/Length mm	Kg
46.820-10	10	0.002
46.820-12	12	0.002
46.820-14	14	0.002
46.820-15	15	0.002
46.820-16	16	0.002

MSA	Longueur/Length mm	Kg
46.820-17	17	0.002
46.820-18	18	0.002
46.820-20	20	0.002
46.820-22	22	0.002
46.820-24	24	0.002



Vis pour barrettes à vis ; laiton plaqué or 2N18 1 µ et laiton palladium 1 µ.
 Screw for screw-on bars ; brass gold-plated 2N18 1 µ and palladium brass 1 µ.
 Schraube für Schraubstege ; Messing vergoldet 2N18 1 µ und Messing Palladium 1 µ.
 Tornillo para pasadores de rosca ; latón dorado 2N18 1 µ y latón paladio 1 µ.
 Vite per anse a vite ; ottone placcato oro 2N18 1 µ e ottone palladio 1 µ.
 Parafuso para pinos de rosca ; latão banhado a ouro 2N18 1 µ e latão paládio 1 µ.

MSA	Laiton plaqué/Brass gold-plated	Dimension/Size mm	MSA	Laiton palladium/ Palladium brass
46.821		Ø 3.20x1.15 / M 1.00 / L 3.60	46.822	
46.823		Ø 3.70x1.15 / M 1.00 / L 4.00	46.824	

Kg 0.001 1/1

46.820 -10mm	46.820 -12mm	46.820 -14mm	46.820 -15mm	46.821 Ø 3.2 mm Gold pl.	46.822 Ø 3.2 mm Palladium
16 barrettes à vis + 32 vis 16 screw-on bars + 32 screws 16 pasadores rosca + 32 tornillos 16 anse a vite + 32 viti MSA 99.056 48 pcs					
46.820 -10mm	46.820 -17mm	46.820 -18mm	46.820 -20mm	46.823 Ø 3.7 mm Gold pl.	46.824 Ø 3.7 mm Palladium

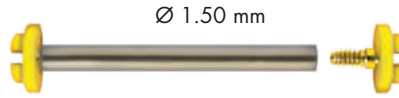
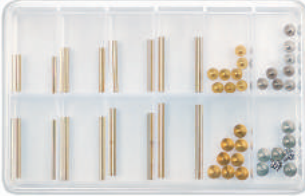

Assortiment de barrettes à vis ; maillechort.
 Assortiment of screw-on bars ; nickel silver.
 Sortiment von Schraubstege ; Neusilber.
 Surtido de pasadores de rosca ; alpaca.
 Assortimento di anse a vite ; argenteone.
 Sortido de pinos de rosca ; níquel plateado.

Contenu - Contents - Inhalt - Contenido - Contenuto - Conteúdo :
8+4 modèles - models - Modelle - modelos - modelli - modelos
2x MSA46.820-10 /-12 /-14 /-15 /-16 /-17 /-18 /-20
8x MSA46.821 /.822 /.823 /.824

MSA	Qt.	Kg
99.056	16x + 32x	0.089

46.820 -10mm	46.820 -12mm	46.820 -14mm	46.820 -15mm	46.821 Ø 3.2 mm Gold pl.	46.822 Ø 3.2 mm Palladium
80 barrettes à vis moicoy + 160 vis 80 bar screw-on bars + 160 screws 80 pasadores rosca inox + 160 tornillos 80 anse a vite acciaio + 160 viti MSA 99.061 240 pcs					
46.820 -16mm	46.820 -17mm	46.820 -18mm	46.820 -20mm	46.823 Ø 3.7 mm Gold pl.	46.824 Ø 3.7 mm Palladium



Assortiment de barrettes à vis ; maillechort.
 Assortiment of screw-on bars ; nickel silver.
 Sortiment von Schraubstege ; Neusilber.
 Surtido de pasadores de rosca ; alpaca.
 Assortimento di anse a vite ; argenteone.
 Sortido de pinos de rosca ; níquel plateado.

Contenu - Contents - Inhalt - Contenido - Contenuto - Conteúdo :
8+4 modèles - models - Modelle - modelos - modelli - modelos
10x MSA46.820-10 /-12 /-14 /-15 /-16 /-17 /-18 /-20
40x MSA46.821 /.822 /.823 /.824

MSA	Qt.	Kg
99.061	80x + 160x	0.345



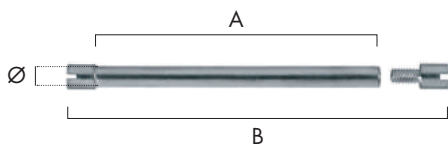

Barrette à vis extra-large + vis ; acier inoxydable.
 Extra large screw-on bar + screw ; stainless steel.
 Extra breiter Schraubsteg + Schraube ; Edelstahl.
 Pasador de rosca extra-ancho + tornillo ; acero inoxidable.
 Ansa a vite super lunga + vite ; acciaio inossidabile.
 Pino de rosca extra-largo + parafuso ; aço inoxidável.

10
pcs

MSA	1/1	Ø mm	A mm	B mm	Kg
46.391		1.40	26.70	30.20	0.005
46.392		1.50	23.00	27.50	0.005
46.393		1.50	25.60	30.50	0.005
46.394		1.70	24.00	28.80	0.006
46.396		1.70	25.00	30.00	0.006
46.395		1.80	25.40	30.50	0.007



Assortiment de barrettes à vis extra-larges ; acier inoxydable.
 Assortment of extra large screw-on bars ; stainless steel.
 Sortiment von extra breite Schraubstege ; Edelstahl.
 Surtido de pasadores de rosca extra-anchos ; acero inoxidable.
 Assortimento di anse a vite super lunghe ; acciaio inossidabile.
 Sortido de pinos de rosca extra-largos ; aço inoxidável.

MSA	Qt.	Kg
99.195	60x	0.056

Contenu - Contents - Inhalt - Contenido - Contenuto - Conteúdo :
6 modèles - models - Modelle - modelos - modelli - modelos
10x MSA46.391 /.392 /.393 /.394 /.395 /.396

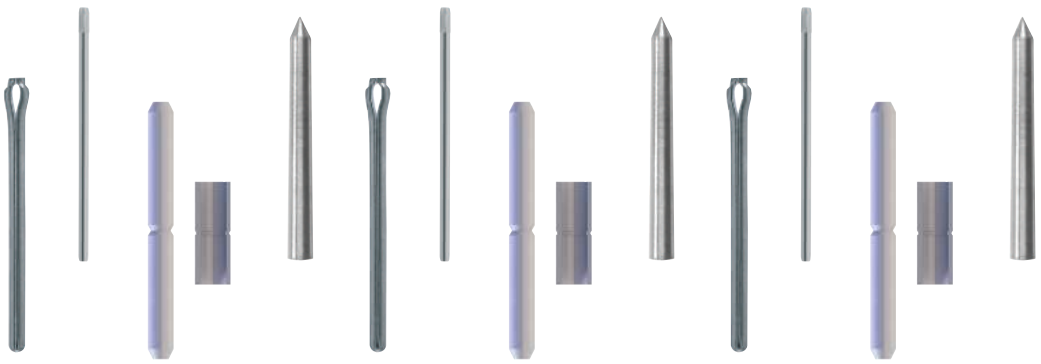

GOUPILLES PINS STIFTEN GRUPILLAS COPIGLIE CAVILHAS

Goupilles fendues

Open-end pins

Splinte

Grupillas hendidas

Copiglie spaccate

Cavilhas rachadas



2

Goupilles moletées

Knurled pins

Gerändelten Stiften

Grupillas moleteadas

Copiglie ziggrinate

Cavilhas serrilhadas

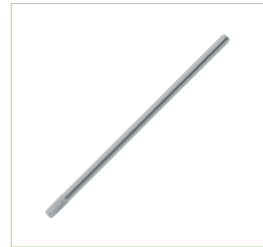

12

Tubes et goupilles avec encoche

Tubes and pins with notch

Röhre und Stiften mit Kerbe

Tubos y grupillas con muesca

Tubi e copiglie con tacca

Tubos e cavilhas com entalhe

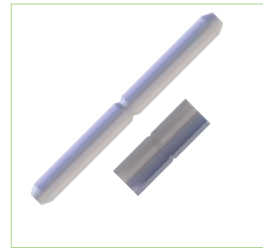

20

Goupilles coniques

Conical pins

Konische Stiften

Grupillas cónicas

Copiglie coniche

Cavilhas cônicas



22



Goupille fendue ; acier inoxydable.

Open-end pin ; stainless steel.

Splint ; Edelstahl.

Grupilla hendida ; acero inoxidable.

Copiglia spaccata ; acciaio inossidabile.

Cavilha rachada ; aço inoxidável.

100
pcs

MSA	Longueur/Length mm	Kg
46.278-04	4	0.002
46.278-06	6	0.003
46.278-08	8	0.003
46.278-10	10	0.004
46.278-12	12	0.004
46.278-14	14	0.005
46.278-15	15	0.005
46.278-16	16	0.006
46.278-17	17	0.006
46.278-18	18	0.007
46.278-19	19	0.007
46.278-20	20	0.007
46.278-21	21	0.007
46.278-22	22	0.007
46.278-23	23	0.008
46.278-24	24	0.009
46.278-25	25	0.009
46.278-26	26	0.009
46.278-27	27	0.009
46.278-28	28	0.009
46.278-29	29	0.010
46.278-30	30	0.011

10
pcs

MSA	Longueur/Length mm	Kg
46.288-04	4	0.001
46.288-06	6	0.001
46.288-08	8	0.001
46.288-10	10	0.001
46.288-12	12	0.001
46.288-14	14	0.001
46.288-15	15	0.001
46.288-16	16	0.001
46.288-17	17	0.001
46.288-18	18	0.001
46.288-19	19	0.001
46.288-20	20	0.001
46.288-21	21	0.001
46.288-22	22	0.001
46.288-23	23	0.001
46.288-24	24	0.001
46.288-25	25	0.001
46.288-26	26	0.001
46.288-27	27	0.001
46.288-28	28	0.001
46.288-29	29	0.001
46.288-30	30	0.001

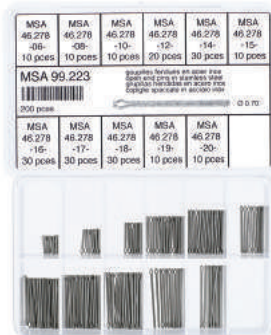

Ø 0.70 mm



Assortiment de goupilles fendues ; acier inoxydable.
 Assortment of open-end pins ; stainless steel.
 Sortiment von Splinte ; Edelstahl.
 Surtido de grupillas hendidas ; acero inoxidable.
 Assortimento di copiglie spaccate ; acciaio inossidabile.
 Sortido de cavilhas rachadas ; aço inoxidável.

Contenu - Contents - Inhalt - Contenido - Contenuto - Conteúdo :
11 modèles - models - Modelle - modelos - modelli - modelos
10x MSA46.278-06 /-08 /-10 /-15 /-19 /-20
20x MSA46.278-12
30x MSA46.278-14 /-16 /-17 /-18

MSA	Qt.	Kg
99.223	200x	0.034

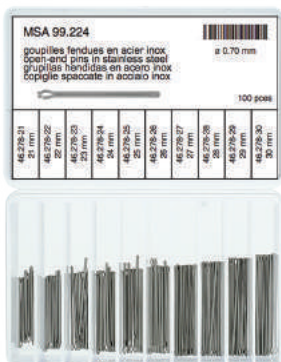

Ø 0.70 mm



Assortiment de goupilles fendues ; acier inoxydable.
 Assortment of open-end pins ; stainless steel.
 Sortiment von Splinte ; Edelstahl.
 Surtido de grupillas hendidas ; acero inoxidable.
 Assortimento di copiglie spaccate ; acciaio inossidabile.
 Sortido de cavilhas rachadas ; aço inoxidável.

Contenu - Contents - Inhalt - Contenido - Contenuto - Conteúdo :
10 modèles - models - Modelle - modelos - modelli - modelos
10x MSA46.278-21 /-22 /-23 /-24 /-25 /-26 /-27 /-28 /-29 /-30

MSA	Qt.	Kg
99.224	100x	0.036

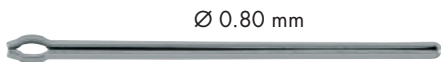

Goupille fendue ; acier inoxydable.

Open-end pin ; stainless steel.

Splint ; Edelstahl.

Grupilla hendida ; acero inoxidable.

Copiglia spaccata ; acciaio inossidabile.

Cavilha rachada ; aço inoxidável.

100
pcs

MSA	Longueur/Length mm	Kg
46.279-04	4	0.003
46.279-06	6	0.004
46.279-08	8	0.004
46.279-10	10	0.005
46.279-12	12	0.005
46.279-14	14	0.006
46.279-15	15	0.006
46.279-16	16	0.007
46.279-17	17	0.007
46.279-18	18	0.008
46.279-19	19	0.008
46.279-20	20	0.008
46.279-21	21	0.008
46.279-22	22	0.008
46.279-23	23	0.009
46.279-24	24	0.010
46.279-25	25	0.010
46.279-26	26	0.010
46.279-27	27	0.010
46.279-28	28	0.010
46.279-29	29	0.011
46.279-30	30	0.012

10
pcs

MSA	Longueur/Length mm	Kg
46.289-04	4	0.001
46.289-06	6	0.001
46.289-08	8	0.001
46.289-10	10	0.001
46.289-12	12	0.001
46.289-14	14	0.001
46.289-15	15	0.001
46.289-16	16	0.001
46.289-17	17	0.001
46.289-18	18	0.001
46.289-19	19	0.001
46.289-20	20	0.002
46.289-21	21	0.002
46.289-22	22	0.002
46.289-23	23	0.002
46.289-24	24	0.002
46.289-25	25	0.002
46.289-26	26	0.002
46.289-27	27	0.002
46.289-28	28	0.002
46.289-29	29	0.002
46.289-30	30	0.002



Ø 0.80 mm



Assortiment de goupilles fendues ; acier inoxydable.

Assortiment of open-end pins ; stainless steel.

Sortiment von Splinte ; Edelstahl.

Surtido de grupillas hendidas ; acero inoxidable.

Assortimento di copiglie spaccate ; acciaio inossidabile.

Sortido de cavilhas rachadas ; aço inoxidável.

Contenu - Contents - Inhalt - Contenido - Contenuto - Conteúdo :
11 modèles - models - Modelle - modelos - modelli - modelos
10x MSA46.279-06 /-08 /-10 /-15 /-19 /-20
20x MSA46.279-12
30x MSA46.279-14 /-16 /-17 /-18

MSA	Qt.	Kg
99.137	200x	0.040



Ø 0.80 mm



Assortiment de goupilles fendues ; acier inoxydable.

Assortiment of open-end pins ; stainless steel.

Sortiment von Splinte ; Edelstahl.

Surtido de grupillas hendidas ; acero inoxidable.

Assortimento di copiglie spaccate ; acciaio inossidabile.

Sortido de cavilhas rachadas ; aço inoxidável.

Contenu - Contents - Inhalt - Contenido - Contenuto - Conteúdo :
10 modèles - models - Modelle - modelos - modelli - modelos
10x MSA46.279-21 /-22 /-23 /-24 /-25 /-26 /-27 /-28 /-29 /-30

MSA	Qt.	Kg
99.145	100x	0.035



Goupille fendue ; acier inoxydable.

Open-end pin ; stainless steel.

Splint ; Edelstahl.

Grupilla hendida ; acero inoxidable.

Copiglia spaccata ; acciaio inossidabile.

Cavilha rachada ; aço inoxidável.

100
pcs

MSA	Longueur/Length mm	Kg
46.280-04	4	0.003
46.280-06	6	0.004
46.280-08	8	0.004
46.280-10	10	0.005
46.280-12	12	0.005
46.280-14	14	0.006
46.280-15	15	0.006
46.280-16	16	0.007
46.280-17	17	0.007
46.280-18	18	0.008
46.280-19	19	0.008
46.280-20	20	0.008
46.280-21	21	0.008
46.280-22	22	0.008
46.280-23	23	0.009
46.280-24	24	0.010
46.280-25	25	0.010
46.280-26	26	0.010
46.280-27	27	0.010
46.280-28	28	0.010
46.280-29	29	0.011
46.280-30	30	0.012

10
pcs

MSA	Longueur/Length mm	Kg
46.290-04	4	0.001
46.290-06	6	0.001
46.290-08	8	0.001
46.290-10	10	0.001
46.290-12	12	0.001
46.290-14	14	0.001
46.290-15	15	0.001
46.290-16	16	0.001
46.290-17	17	0.001
46.290-18	18	0.001
46.290-19	19	0.001
46.290-20	20	0.002
46.290-21	21	0.002
46.290-22	22	0.002
46.290-23	23	0.002
46.290-24	24	0.002
46.290-25	25	0.002
46.290-26	26	0.002
46.290-27	27	0.002
46.290-28	28	0.002
46.290-29	29	0.002
46.290-30	30	0.002



Ø 0.90 mm



Assortiment de goupilles fendues ; acier inoxydable.

Assortiment of open-end pins ; stainless steel.

Sortiment von Splinte ; Edelstahl.

Surtido de grupillas hendidas ; acero inoxidable.

Assortimento di copiglie spaccate ; acciaio inossidabile.

Sortido de cavilhas rachadas ; aço inoxidável.

Contenu - Contents - Inhalt - Contenido - Contenuto - Conteúdo :

11 modèles - models - Modelle - modelos - modelli - modelos

10x MSA46.280-06 /-08 /-10 /-15 /-19 /-20

20x MSA46.280-12

30x MSA46.280-14 /-16 /-17 /-18

MSA	Qt.	Kg
99.048	200x	0.041



Ø 0.90 mm



Assortiment de goupilles fendues ; acier inoxydable.

Assortiment of open-end pins ; stainless steel.

Sortiment von Splinte ; Edelstahl.

Surtido de grupillas hendidas ; acero inoxidable.

Assortimento di copiglie spaccate ; acciaio inossidabile.

Sortido de cavilhas rachadas ; aço inoxidável.

Contenu - Contents - Inhalt - Contenido - Contenuto - Conteúdo :

10 modèles - models - Modelle - modelos - modelli - modelos

10x MSA46.280-21 /-22 /-23 /-24 /-25 /-26 /-27 /-28 /-29 /-30

MSA	Qt.	Kg
99.146	100x	0.028

Ø 1.00 mm



Goupille fendue ; acier inoxydable.

Open-end pin ; stainless steel.

Splint ; Edelstahl.

Grupilla hendida ; acero inoxidable.

Copiglia spaccata ; acciaio inossidabile.

Cavilha rachada ; aço inoxidável.

100
pcs

MSA	Longueur/Length mm	Kg
46.281-04	4	0.004
46.281-06	6	0.006
46.281-08	8	0.007
46.281-10	10	0.010
46.281-12	12	0.011
46.281-14	14	0.013
46.281-15	15	0.014
46.281-16	16	0.015
46.281-17	17	0.015
46.281-18	18	0.017
46.281-19	19	0.017
46.281-20	20	0.018
46.281-21	21	0.019
46.281-22	22	0.020
46.281-23	23	0.020
46.281-24	24	0.021
46.281-25	25	0.022
46.281-26	26	0.024
46.281-27	27	0.024
46.281-28	28	0.025
46.281-29	29	0.026
46.281-30	30	0.027

10
pcs

MSA	Longueur/Length mm	Kg
46.291-04	4	0.001
46.291-06	6	0.001
46.291-08	8	0.001
46.291-10	10	0.001
46.291-12	12	0.001
46.291-14	14	0.001
46.291-15	15	0.001
46.291-16	16	0.002
46.291-17	17	0.002
46.291-18	18	0.002
46.291-19	19	0.002
46.291-20	20	0.002
46.291-21	21	0.002
46.291-22	22	0.002
46.291-23	23	0.002
46.291-24	24	0.002
46.291-25	25	0.002
46.291-26	26	0.003
46.291-27	27	0.003
46.291-28	28	0.003
46.291-29	29	0.003
46.291-30	30	0.003

MSA 46.281 -06- 10 pces	MSA 46.281 -08- 10 pces	MSA 46.281 -10- 10 pces	MSA 46.281 -12- 20 pces	MSA 46.281 -14- 30 pces	MSA 46.281 -15- 10 pces
MSA 99.049 goupilles fendues en acier inox open-end pins in stainless steel grupillas hendidas en acero inox copiglie spaccate in acciaio inox Ø 1.00 200 pces					
MSA 46.281 -16- 30 pces	MSA 46.281 -17- 30 pces	MSA 46.281 -18- 30 pces	MSA 46.281 -19- 10 pces	MSA 46.281 -20- 10 pces	



Ø 1.00 mm



Assortiment de goupilles fendues ; acier inoxydable.

Assortment of open-end pins ; stainless steel.

Sortiment von Splinte ; Edelstahl.

Surtido de grupillas hendidas ; acero inoxidable.

Assortimento di copiglie spaccate ; acciaio inossidabile.

Sortido de cavilhas rachadas ; aço inoxidável.

Contenu - Contents - Inhalt - Contenido - Contenuto - Conteúdo :
11 modèles - models - Modelle - modelos - modelli - modelos
10x MSA46.281-06 /-08 /-10 /-15 /-19 /-20
20x MSA46.281-12
30x MSA46.281-14 /-16 /-17 /-18

MSA	Qt.	Kg
99.049	200x	0.045

Assortiment MSA 99.147		100 pces
Goupilles fendues, acier inox Open-end pins, stain. steel Grupillas hendidas, acero inox Copiglie spaccate, acciaio inox		Ø 1.00 mm
46.281-21 21 mm	46.281-22 22 mm	46.281-23 23 mm
46.281-24 24 mm	46.281-25 25 mm	46.281-26 26 mm
46.281-27 27 mm	46.281-28 28 mm	46.281-29 29 mm
46.281-30 30 mm		



Ø 1.00 mm



Assortiment de goupilles fendues ; acier inoxydable.

Assortment of open-end pins ; stainless steel.

Sortiment von Splinte ; Edelstahl.

Surtido de grupillas hendidas ; acero inoxidable.

Assortimento di copiglie spaccate ; acciaio inossidabile.

Sortido de cavilhas rachadas ; aço inoxidável.

Contenu - Contents - Inhalt - Contenido - Contenuto - Conteúdo :
10 modèles - models - Modelle - modelos - modelli - modelos
10x MSA46.281-21 /-22 /-23 /-24 /-25 /-26 /-27 /-28 /-29 /-30

MSA	Qt.	Kg
99.147	100x	0.028

Ø 1.20 mm



Goupille fendue ; acier inoxydable.

Open-end pin ; stainless steel.

Splint ; Edelstahl.

Grupilla hendida ; acero inoxidable.

Copiglia spaccata ; acciaio inossidabile.

Cavilha rachada ; aço inoxidável.

100
pcs

MSA	Longueur/Length mm	Kg
46.282-04	4	0.004
46.282-06	6	0.006
46.282-08	8	0.007
46.282-10	10	0.010
46.282-12	12	0.011
46.282-14	14	0.013
46.282-15	15	0.014
46.282-16	16	0.015
46.282-17	17	0.015
46.282-18	18	0.017
46.282-19	19	0.017
46.282-20	20	0.018
46.282-21	21	0.019
46.282-22	22	0.020
46.282-23	23	0.020
46.282-24	24	0.021
46.282-25	25	0.022
46.282-26	26	0.024
46.282-27	27	0.024
46.282-28	28	0.025
46.282-29	29	0.026
46.282-30	30	0.027

10
pcs

MSA	Longueur/Length mm	Kg
46.292-04	4	0.001
46.292-06	6	0.001
46.292-08	8	0.001
46.292-10	10	0.001
46.292-12	12	0.001
46.292-14	14	0.001
46.292-15	15	0.001
46.292-16	16	0.002
46.292-17	17	0.002
46.292-18	18	0.002
46.292-19	19	0.002
46.292-20	20	0.002
46.292-21	21	0.002
46.292-22	22	0.002
46.292-23	23	0.002
46.292-24	24	0.002
46.292-25	25	0.002
46.292-26	26	0.003
46.292-27	27	0.003
46.292-28	28	0.003
46.292-29	29	0.003
46.292-30	30	0.003



Ø 1.20 mm



Assortiment de goupilles fendues ; acier inoxydable.
 Assortment of open-end pins ; stainless steel.
 Sortiment von Splinte ; Edelstahl.
 Surtido de grupillas hendidas ; acero inoxidable.
 Assortimento di copiglie spaccate ; acciaio inossidabile.
 Sortido de cavilhas rachadas ; aço inoxidável.

Contenu - Contents - Inhalt - Contenido - Contenuto - Conteúdo :
11 modèles - models - Modelle - modelos - modelli - modelos
10x MSA46.282-06 /-08 /-10 /-15 /-19 /-20
20x MSA46.282-12
30x MSA46.282-14 /-16 /-17 /-18

MSA	Qt.	Kg
99.081	200x	0.051



Ø 1.20 mm

Assortiment de goupilles fendues ; acier inoxydable.
 Assortment of open-end pins ; stainless steel.
 Sortiment von Splinte ; Edelstahl.
 Surtido de grupillas hendidas ; acero inoxidable.
 Assortimento di copiglie spaccate ; acciaio inossidabile.
 Sortido de cavilhas rachadas ; aço inoxidável.

Contenu - Contents - Inhalt - Contenido - Contenuto - Conteúdo :
10 modèles - models - Modelle - modelos - modelli - modelos
10x MSA46.282-21 /-22 /-23 /-24 /-25 /-26 /-27 /-28 /-29 /-30

MSA	Qt.	Kg
99.148	100x	0.050

Ø 0.90 mm



Goupille moletée; acier inoxydable.

Knurled pin; stainless steel.

Gerändelter Stift; Edelstahl.

Grupilla moleteada; acero inoxidable.

Copiglia zigrinata; acciaio inossidabile.

Cavilha serrilhada; aço inoxidável.

100
pcs

MSA	Longueur/Length mm	Kg
46.283-06	6	0.004
46.283-08	8	0.005
46.283-10	10	0.007
46.283-12	12	0.009
46.283-14	14	0.010
46.283-16	16	0.011
46.283-17	17	0.012
46.283-18	18	0.013
46.283-19	19	0.014
46.283-20	20	0.014
46.283-21	21	0.015
46.283-22	22	0.016
46.283-24	24	0.018
46.283-26	26	0.019
46.283-28	28	0.021
46.283-30	30	0.022

10
pcs

MSA	Longueur/Length mm	Kg
46.293-06	6	0.001
46.293-08	8	0.001
46.293-10	10	0.001
46.293-12	12	0.001
46.293-14	14	0.001
46.293-16	16	0.001
46.293-17	17	0.001
46.293-18	18	0.001
46.293-19	19	0.001
46.293-20	20	0.001
46.293-21	21	0.001
46.293-22	22	0.001
46.293-24	24	0.001
46.293-26	26	0.001
46.293-28	28	0.001
46.293-30	30	0.001

46.283 -06mm 10 pcs	46.283 -08mm 10 pcs	46.283 -10mm 10 pcs	46.283 -12mm 16 pcs	46.283 -14mm 10 pcs	46.283 -16mm 30 pcs
goupilles moletées en acier inox knurled pins in stainless steel grupillas moleteadas en acero inox copiglie zigrinate in acciaio inox					
Ø 0.90					
MSA 99.133					
200 pcs					



Ø 0.90 mm

Assortiment de goupilles moletées; acier inoxydable.

Assortment of knurled pins; stainless steel.

Sortiment von gerändelten Stiften; Edelstahl.

Surtido de grupillas moleteadas; acero inoxidable.

Assortimento di copiglie zigrinate; acciaio inossidabile.

Sortido de cavilhas serrilhadas; aço inoxidável.

Contenu - Contents - Inhalt - Contenido - Contenuto - Conteúdo :
12 modèles - models - Modelle - modelos - modelli - modelos
10x MSA46.283-06 /-08 /-10 /-12 /-14 /-17 /-19 /-21 /-22
30x MSA46.283-16
40x MSA46.283-18 /-20

MSA	Qt.	Kg
99.133	200x	0.027

MSA 46.283 -22	MSA 46.283 -24	MSA 46.283 -26	MSA 46.283 -28	MSA 46.283 -30
goupilles moletées en acier inox knurled pins in stainless steel grupillas moleteadas en acero inox copiglie zigrinate in acciaio inox				
Ø 0.90 mm				
MSA 99.210				
200 pcs				

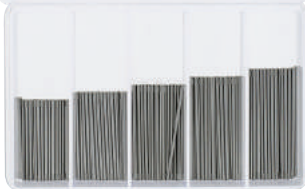

Ø 0.90 mm

Assortiment de goupilles moletées; acier inoxydable.

Assortment of knurled pins; stainless steel.

Sortiment von gerändelten Stiften; Edelstahl.

Surtido de grupillas moleteadas; acero inoxidable.

Assortimento di copiglie zigrinate; acciaio inossidabile.

Sortido de cavilhas serrilhadas; aço inoxidável.

Contenu - Contents - Inhalt - Contenido - Contenuto - Conteúdo :
5 modèles - models - Modelle - modelos - modelli - modelos
40x MSA46.283-22 /-24 /-26 /-28 /-30

MSA	Qt.	Kg
99.210	200x	0.050

Ø 1.00 mm



Goupille moletée; acier inoxydable.

Knurled pin; stainless steel.

Gerändelter Stift; Edelstahl.

Grupilla moleteada; acero inoxidable.

Copiglia zigrinata; acciaio inossidabile.

Cavilha serrilhada; aço inoxidável.

100
pcs

MSA	Longueur/Length mm	Kg
46.284-06	6	0.004
46.284-08	8	0.005
46.284-10	10	0.007
46.284-12	12	0.009
46.284-14	14	0.010
46.284-16	16	0.011
46.284-17	17	0.012
46.284-18	18	0.013
46.284-19	19	0.014
46.284-20	20	0.014
46.284-21	21	0.015
46.284-22	22	0.016
46.284-24	24	0.018
46.284-26	26	0.019
46.284-28	28	0.021
46.284-30	30	0.022

10
pcs

MSA	Longueur/Length mm	Kg
46.294-06	6	0.001
46.294-08	8	0.001
46.294-10	10	0.001
46.294-12	12	0.001
46.294-14	14	0.001
46.294-16	16	0.001
46.294-17	17	0.001
46.294-18	18	0.001
46.294-19	19	0.001
46.294-20	20	0.001
46.294-21	21	0.001
46.294-22	22	0.001
46.294-24	24	0.001
46.294-26	26	0.001
46.294-28	28	0.001
46.294-30	30	0.001

46.284 -06mm 10 pcs	46.284 -08mm 10 pcs	46.284 -10mm 10 pcs	46.284 -12mm 10 pcs	46.284 -14mm 10 pcs	46.284 -18mm 30 pcs
goupilles moletées en acier inox knurled pins in stainless steel grupillas moleteadas en acero inox copiglie zigrinate in acciaio inox MSA 99.134 200 pcs					
46.284 -17mm 10 pcs	46.284 -18mm 40 pcs	46.284 -19mm 10 pcs	46.284 -20mm 40 pcs	46.284 -21mm 10 pcs	46.284 -22mm 10 pcs



Ø 1.00 mm

Assortiment de goupilles moletées; acier inoxydable.

Assortment of knurled pins; stainless steel.

Sortiment von gerändelten Stiften; Edelstahl.

Surtido de grupillas moleteadas; acero inoxidable.

Assortimento di copiglie zigrinate; acciaio inossidabile.

Sortido de cavilhas serrilhadas; aço inoxidável.

Contenu - Contents - Inhalt - Contenido - Contenuto - Conteúdo :
12 modèles - models - Modelle - modelos - modelli - modelos
10x MSA46.284-06 /-08 /-10 /-12 /-14 /-17 /-19 /-21 /-22
30x MSA46.284-16
40x MSA46.284-18 /-20

MSA	Qt.	Kg
99.134	200x	0.027

MSA 46.284 -22	MSA 46.284 -24	MSA 46.284 -26	MSA 46.284 -28	MSA 46.284 -30
goupilles moletées en acier inox knurled pins in stainless steel grupillas moleteadas en acero inox copiglie zigrinate in acciaio inox Ø 1.00 mm MSA 99.211 200 pcs				

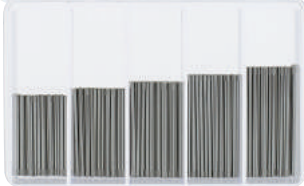

Ø 1.00 mm

Assortiment de goupilles moletées; acier inoxydable.

Assortment of knurled pins; stainless steel.

Sortiment von gerändelten Stiften; Edelstahl.

Surtido de grupillas moleteadas; acero inoxidable.

Assortimento di copiglie zigrinate; acciaio inossidabile.

Sortido de cavilhas serrilhadas; aço inoxidável.

Contenu - Contents - Inhalt - Contenido - Contenuto - Conteúdo :
5 modèles - models - Modelle - modelos - modelli - modelos
40x MSA46.284-22 /-24 /-26 /-28 /-30

MSA	Qt.	Kg
99.211	200x	0.056

Ø 1.10 mm



Goupille moletée; acier inoxydable.

Knurled pin; stainless steel.

Gerändelter Stift; Edelstahl.

Grupilla moleteada; acero inoxidable.

Copiglia zigrinata; acciaio inossidabile.

Cavilha serrilhada; aço inoxidável.

100
pcs

MSA	Longueur/Length mm	Kg
46.285-06	6	0.005
46.285-08	8	0.006
46.285-10	10	0.008
46.285-12	12	0.010
46.285-14	14	0.011
46.285-16	16	0.012
46.285-17	17	0.013
46.285-18	18	0.014
46.285-19	19	0.015
46.285-20	20	0.015
46.285-21	21	0.016
46.285-22	22	0.017
46.285-24	24	0.019
46.285-26	26	0.020
46.285-28	28	0.022
46.285-30	30	0.023

10
pcs

MSA	Longueur/Length mm	Kg
46.295-06	6	0.001
46.295-08	8	0.001
46.295-10	10	0.001
46.295-12	12	0.001
46.295-14	14	0.001
46.295-16	16	0.001
46.295-17	17	0.001
46.295-18	18	0.001
46.295-19	19	0.001
46.295-20	20	0.001
46.295-21	21	0.001
46.295-22	22	0.001
46.295-24	24	0.001
46.295-26	26	0.001
46.295-28	28	0.001
46.295-30	30	0.001

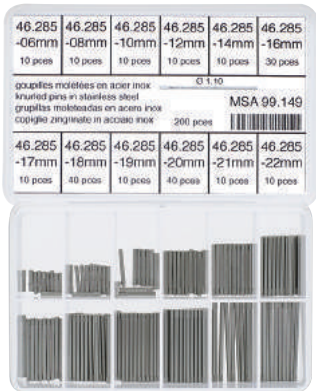

MSA	Qt.	Kg
99.149	200x	0.050

Ø 1.10 mm

Assortiment de goupilles moletées; acier inoxydable.
 Assortment of knurled pins; stainless steel.
 Sortiment von gerändelten Stiften; Edelstahl.
 Surtido de grupillas moleteadas; acero inoxidable.
 Assortimento di copiglie zigrinate; acciaio inossidabile.
 Sortido de cavilhas serrilhadas; aço inoxidável.

Contenu - Contents - Inhalt - Contenido - Contenuto - Conteúdo :
12 modèles - models - Modelle - modelos - modelli - modelos
10x MSA46.285-06 /-08 /-10 /-12 /-14 /-17 /-19 /-21 /-22
30x MSA46.285-16
40x MSA46.285-18 /-20

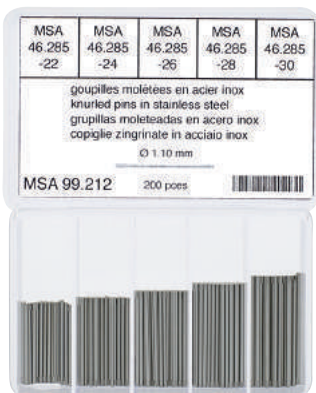

MSA	Qt.	Kg
99.212	200x	0.063

Ø 1.10 mm

Assortiment de goupilles moletées; acier inoxydable.
 Assortment of knurled pins; stainless steel.
 Sortiment von gerändelten Stiften; Edelstahl.
 Surtido de grupillas moleteadas; acero inoxidable.
 Assortimento di copiglie zigrinate; acciaio inossidabile.
 Sortido de cavilhas serrilhadas; aço inoxidável.

Contenu - Contents - Inhalt - Contenido - Contenuto - Conteúdo :
5 modèles - models - Modelle - modelos - modelli - modelos
40x MSA46.285-22 /-24 /-26 /-28 /-30

Ø 1.20 mm



Goupille moletée; acier inoxydable.

Knurled pin; stainless steel.

Gerändelter Stift; Edelstahl.

Grupilla moleteada; acero inoxidable.

Copiglia zigrinata; acciaio inossidabile.

Cavilha serrilhada; aço inoxidável.

100
pcs

MSA	Longueur/Length mm	Kg
46.286-06	6	0.006
46.286-08	8	0.008
46.286-10	10	0.009
46.286-12	12	0.011
46.286-14	14	0.013
46.286-16	16	0.015
46.286-17	17	0.015
46.286-18	18	0.017
46.286-19	19	0.017
46.286-20	20	0.018
46.286-21	21	0.019
46.286-22	22	0.020
46.286-24	24	0.021
46.286-26	26	0.023
46.286-28	28	0.025
46.286-30	30	0.027

10
pcs

MSA	Longueur/Length mm	Kg
46.296-06	6	0.001
46.296-08	8	0.001
46.296-10	10	0.001
46.296-12	12	0.001
46.296-14	14	0.001
46.296-16	16	0.001
46.296-17	17	0.001
46.296-18	18	0.001
46.296-19	19	0.001
46.296-20	20	0.001
46.296-21	21	0.001
46.296-22	22	0.001
46.296-24	24	0.001
46.296-26	26	0.001
46.296-28	28	0.001
46.296-30	30	0.001

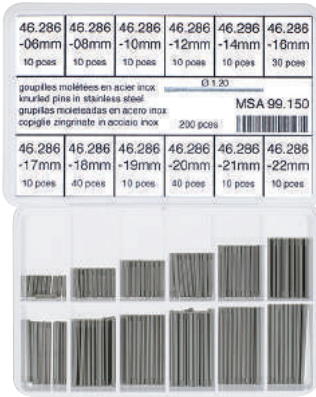

MSA	Qt.	Kg
99.150	200x	0.054

Ø 1.20 mm

Assortiment de goupilles moletées; acier inoxydable.
 Assortment of knurled pins; stainless steel.
 Sortiment von gerändelten Stiften; Edelstahl.
 Surtido de grupillas moleteadas; acero inoxidable.
 Assortimento di copiglie zigrinate; acciaio inossidabile.
 Sortido de cavilhas serrilhadas; aço inoxidável.

Contenu - Contents - Inhalt - Contenido - Contenuto - Conteúdo :
12 modèles - models - Modelle - modelos - modelli - modelos
10x MSA46.286-06 /-08 /-10 /-12 /-14 /-17 /-19 /-21 /-22
30x MSA46.286-16
40x MSA46.286-18 /-20

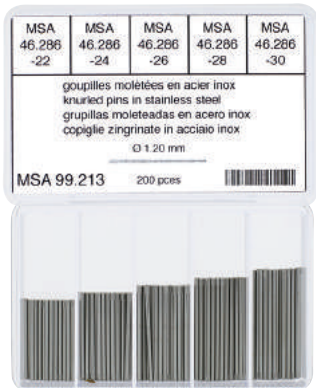

MSA	Qt.	Kg
99.213	200x	0.070

Ø 1.20 mm

Assortiment de goupilles moletées; acier inoxydable.
 Assortment of knurled pins; stainless steel.
 Sortiment von gerändelten Stiften; Edelstahl.
 Surtido de grupillas moleteadas; acero inoxidable.
 Assortimento di copiglie zigrinate; acciaio inossidabile.
 Sortido de cavilhas serrilhadas; aço inoxidável.

Contenu - Contents - Inhalt - Contenido - Contenuto - Conteúdo :
5 modèles - models - Modelle - modelos - modelli - modelos
40x MSA46.286-22 /-24 /-26 /-28 /-30

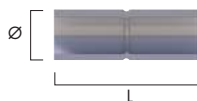
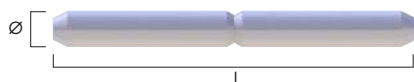

10
pcs

MSA	Tube/Tube L x Ø mm	Goupille/Pin L x Ø mm	Kg
46.815-10	12 x 1.00	30 x 0.70	0.003
46.815-11	12 x 1.10	30 x 0.80	0.003
46.815-12	12 x 1.20	30 x 0.90	0.003
46.815-13	12 x 1.30	30 x 1.00	0.003
46.815-15	12 x 1.50	30 x 1.10	0.003
46.815-16	12 x 1.60	30 x 1.20	0.003
46.815-17	12 x 1.70	30 x 1.30	0.003
46.815-18	12 x 1.80	30 x 1.40	0.003

Tube et goupille avec **encoche centrale** ; acier inoxydable.
 Tube and pin with **central notch** ; stainless steel.
 Rohr und Stift mit **zentraler Kerbe** ; Edelstahl.
 Tubo y grupilla con **muesca central** ; acero inoxidable.
 Tubo e copiglia con **tacca centrale** ; acciaio inossidabile.
 Tubo e cavilha com **entalhe central** ; aço inoxidável.



Assortiment de tubes et goupilles avec **encoche centrale** ; acier inoxydable.
 Assortment of tubes and pins with **central notch** ; stainless steel.
 Sortiment von Röhre und Stiften mit **zentraler Kerbe** ; Edelstahl.
 Surtido de tubos y grupillas con **muesca central** ; acero inoxidable.
 Assortimento di tubi e copiglie con **tacca centrale** ; acciaio inossidabile.
 Sortido de tubos e cavilhas com **entalhe central** ; aço inoxidável.

MSA	Qt.	Kg
99.251	40x + 40x	0.040

Contenu - Contents - Inhalt - Contenido - Contenuto - Conteúdo :
8 modèles - models - Modelle - modelos - modelli - modelos
5x MSA46.815-10 /-11 /-12 /-13 /-15 /-16 /-17 /-18

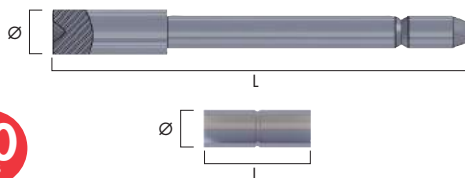

Tube et goupille avec **encoche latérale** ; acier inoxydable.
 Tube and pin with **side notch** ; stainless steel.
 Rohr und Stift mit **seiten Kerbe** ; Edelstahl.
 Tubo y grupilla con **muesca lateral** ; acero inoxidable.
 Tubo e copiglia con **tacca laterale** ; acciaio inossidabile.
 Tubo e cavilha com **entalhe lateral** ; aço inoxidável.

MSA	Tube/Tube L x Ø mm	Goupille/Pin L x Ø mm	Kg
46.817-08	3 x 1.20	8 x 0.90	0.004
46.817-09	3 x 1.20	9 x 0.90	0.004
46.817-10	3 x 1.20	10 x 0.90	0.004
46.817-11	3 x 1.20	11 x 0.90	0.004
46.817-12	3 x 1.20	12 x 0.90	0.004
46.817-13	3 x 1.20	13 x 0.90	0.004
46.817-14	4 x 1.20	14 x 0.90	0.004
46.817-15	4 x 1.20	15 x 0.90	0.004
46.817-16	4 x 1.20	16 x 0.90	0.004
46.817-17	4 x 1.20	17 x 0.90	0.004
46.817-18	4 x 1.20	18 x 0.90	0.004
46.817-19	4 x 1.20	19 x 0.90	0.004

MSA	Tube/Tube L x Ø mm	Goupille/Pin L x Ø mm	Kg
46.817-20	4 x 1.20	20 x 0.90	0.004
46.817-21	4 x 1.20	21 x 0.90	0.004
46.817-22	4 x 1.20	22 x 0.90	0.004
46.817-23	4 x 1.20	23 x 0.90	0.004
46.817-24	4 x 1.20	24 x 0.90	0.004
46.817-25	4 x 1.20	25 x 0.90	0.004
46.817-26	4 x 1.20	26 x 0.90	0.004
46.817-27	4 x 1.20	27 x 0.90	0.004
46.817-28	4 x 1.20	28 x 0.90	0.004
46.817-29	4 x 1.20	29 x 0.90	0.004
46.817-30	4 x 1.20	30 x 0.90	0.004



Assortiment de tubes et goupilles avec **encoche latérale** ; acier inoxydable.
 Assortment of tubes and pins with **side notch** ; stainless steel.
 Sortiment von Röhre und Stiften mit **seiten Kerbe** ; Edelstahl.
 Surtido de tubos y grupillas con **muesca lateral** ; acero inoxidable.
 Assortimento di tubi e copiglie con **tacca laterale** ; acciaio inossidabile.
 Sortido de tubos e cavilhas com **entalhe lateral** ; aço inoxidável.

MSA	Qt.	Kg
99.252	50x + 50x	0.050

**Contenu - Contents - Inhalt - Contenido - Contenuto - Conteúdo :
 10 modèles - models - Modelle - modelos - modelli - modelos
 5x MSA46.817-10 /-12 /-14 /-16 /-18 /-20 /-22 /-24 /-26 /-28**

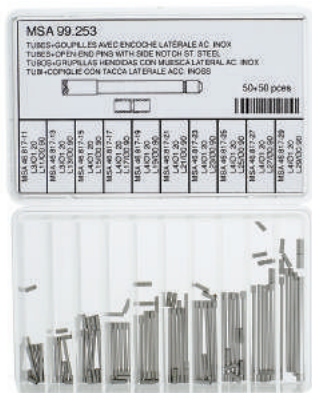

Assortiment de tubes et goupilles avec **encoche latérale** ; acier inoxydable.
 Assortment of tubes and pins with **side notch** ; stainless steel.
 Sortiment von Röhre und Stiften mit **seiten Kerbe** ; Edelstahl.
 Surtido de tubos y grupillas con **muesca lateral** ; acero inoxidable.
 Assortimento di tubi e copiglie con **tacca laterale** ; acciaio inossidabile.
 Sortido de tubos e cavilhas com **entalhe lateral** ; aço inoxidável.

MSA	Qt.	Kg
99.253	50x + 50x	0.050



Assortiment de goupilles coniques ; laiton.
 Assortment of conical pins ; brass.
 Sortiment von konische Stiften ; Messing.
 Surtido de grupillas cónicas ; latón.
 Assortimento di copiglie coniche ; ottone.
 Sortido de cavilhas cónicas ; latão.

PERF	Qt.	Kg
48.000	100x	0.027



Assortiment de goupilles coniques ; acier.
 Assortment of conical pins ; steel.
 Sortiment von konische Stiften ; Stahl.
 Surtido de grupillas cónicas ; acero.
 Assortimento di copiglie coniche ; acciaio.
 Sortido de cavilhas cónicas ; aço.

PERF	Qt.	Kg
48.001	100x	0.026

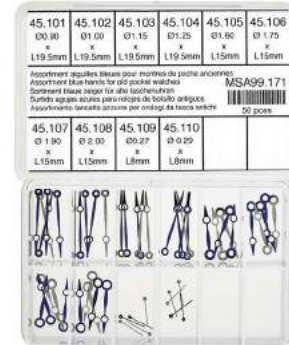
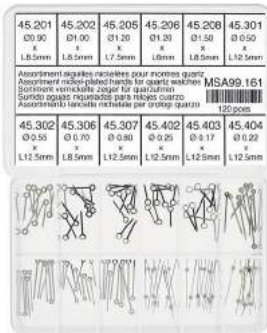

AIGUILLES POUR MONTRES ■ HANDS FOR WATCHES ■ ZEIGER FÜR UHREN
AGUJAS PARA RELOJES ■ LANCETTE PER OROLOGI

04 - 2

AIGUILLES POUR MONTRES ANCIENNES ■ HANDS FOR OLD WATCHES ■ ZEIGER FÜR ALTE UHREN
AGUJAS PARA RELOJES ANTIGUOS ■ LANCETTE PER OROLOGI ANTICHI

04 - 8



Aiguille pour montres emballées sur carte, 10 pièces.
 Hand for watches packed on card, 10 pieces.
 Zeiger für Uhren auf Karte verpackt, 10 Stück.
 Aguja para relojes embaladas en tarjeta, 10 piezas.
 Lancetta per orologi imballate su carta, 10 pezzi.

Heures - Hours - Stunden - Horas - Ore

Couleur/Colour : Nickel/Nickel

Couleur/Colour : Jaune/Yellow

Couleur/Colour : Noir/Black

MSA	Ø trou mm Ø hole mm	L mm	Kg
45.200	0.80	8.50	0.004
45.201	0.90	8.50	0.004
45.202	1.00	8.50	0.004
45.203	1.10	8.50	0.004
45.206	1.20	6.00	0.004
45.205	1.20	7.50	0.004
45.204	1.20	8.50	0.004
45.207	1.30	8.50	0.004
45.208	1.50	8.50	0.004

MSA	Ø trou mm Ø hole mm	L mm	Kg
45.600	0.80	8.50	0.004
45.601	0.90	8.50	0.004
45.602	1.00	8.50	0.004
45.603	1.10	8.50	0.004
45.606	1.20	6.00	0.004
45.605	1.20	7.50	0.004
45.604	1.20	8.50	0.004
45.607	1.30	8.50	0.004
45.608	1.50	8.50	0.004

MSA	Ø trou mm Ø hole mm	L mm	Kg
45.900	0.80	8.50	0.004
45.901	0.90	8.50	0.004
45.902	1.00	8.50	0.004
45.903	1.10	8.50	0.004
45.906	1.20	6.00	0.004
45.905	1.20	7.50	0.004
45.904	1.20	8.50	0.004
45.907	1.30	8.50	0.004
45.908	1.50	8.50	0.004



Aiguille pour montres emballées sur carte ; couleur nickel, jaune et noire.
 Hand for watches packed on card, 10 pièces.
 Zeiger für Uhren auf Karte verpackt, 10 Stück.
 Aguja para relojes embaladas en tarjeta, 10 piezas.
 Lancetta per orologi imballate su carta, 10 pezzi.

Minutes - Minutes - Minuten - Minutos - Minuti

Couleur/Colour : Nickel/Nickel

Couleur/Colour : Jaune/Yellow

Couleur/Colour : Noir/Black

MSA	Ø trou mm Ø hole mm	L mm	Kg
45.300	0.40	12.50	0.004
45.301	0.50	12.50	0.004
45.302	0.55	12.50	0.004
45.303	0.60	12.50	0.004
45.309	0.65	12.50	0.004
45.306	0.70	8.50	0.004
45.305	0.70	10.50	0.004
45.304	0.70	12.50	0.004
45.307	0.80	12.50	0.004
45.308	0.90	12.50	0.004

MSA	Ø trou mm Ø hole mm	L mm	Kg
45.700	0.40	12.50	0.004
45.701	0.50	12.50	0.004
45.702	0.55	12.50	0.004
45.703	0.60	12.50	0.004
45.709	0.65	12.50	0.004
45.706	0.70	8.50	0.004
45.705	0.70	10.50	0.004
45.704	0.70	12.50	0.004
45.707	0.80	12.50	0.004
45.708	0.90	12.50	0.004

MSA	Ø trou mm Ø hole mm	L mm	Kg
45.500	0.40	12.50	0.004
45.501	0.50	12.50	0.004
45.502	0.55	12.50	0.004
45.503	0.60	12.50	0.004
45.506	0.70	8.50	0.004
45.505	0.70	10.50	0.004
45.504	0.70	12.50	0.004
45.507	0.80	12.50	0.004
45.508	0.90	12.50	0.004



Aiguille pour montres emballées sur carte, 10 pièces.
 Hand for watches packed on card, 10 pieces.
 Zeiger für Uhren auf Karte verpackt, 10 Stück.

**Seconde au centre - Centre second -
 Zentrumsekunden - Segundero central -
 Secondi al centro**

Aguja para relojes embaladas en tarjeta, 10 piezas.
 Lancetta per orologi imballate su carta, 10 pezzi.

Couleur/Colour : Nickel/Nickel

Couleur/Colour : Jaune/Yellow

Couleur/Colour : Noir/Black

MSA	Ø trou mm Ø hole mm	L mm	Kg
45.403	0.17	12.50	0.004
45.400	0.18	12.50	0.004
45.401	0.20	12.50	0.004
45.404	0.22	12.50	0.004
45.402	0.25	12.50	0.004

MSA	Ø trou mm Ø hole mm	L mm	Kg
45.803	0.17	12.50	0.004
45.800	0.18	12.50	0.004
45.801	0.20	12.50	0.004
45.804	0.22	12.50	0.004
45.802	0.25	12.50	0.004

MSA	Ø trou mm Ø hole mm	L mm	Kg
45.853	0.17	12.50	0.004
45.850	0.18	12.50	0.004
45.851	0.20	12.50	0.004
45.854	0.22	12.50	0.004
45.852	0.25	12.50	0.004



MSA	Qté. / Qty.	Kg
99.161	120x	0.026

Assortiment d'aiguilles couleur nickel pour montres ; heures, minutes et secondes au centre.
 Assortment of nickel colour hands for watches ; hours, minutes and centre seconds.
 Sortiment von Nickel-Farbe Zeiger für Uhren ; Stunden, Minuten und Zentrumsekunden.
 Surtido de agujas color níquel para relojes ; horas, minutos y segundos centrales.
 Assortimento di lancette colore nichel per orologi ; ore, minuti e secondi al centro.

Contenu - Contents - Inhalt - Contenido - Contenuto : 12 modèles - models - Modelle - modelos - modelli
10x MSA45.201 (Ø 0.90 mm) .202 (1.00) .205 (1.20) .206 (1.20) .208 (1.50) .301 (0.50) .302 (0.55) .306 (0.70) .307 (0.80)
.402 (0.25) .403 (0.17) .404 (0.22)

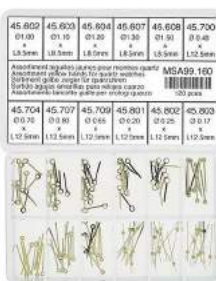

MSA	Qté. / Qty.	Kg
99.160	120x	0.026

Assortiment d'aiguilles jaunes pour montres ; heures, minutes et secondes au centre.
 Assortment of yellow hands for watches ; hours, minutes and centre seconds.
 Sortiment von gelbe Zeiger für Uhren ; Stunden, Minuten und Zentrumsekunden.
 Surtido de agujas amarillas para relojes ; horas, minutos y segundos centrales.
 Assortimento di lancette gialle per orologi ; ore, minuti e secondi al centro.

Contenu - Contents - Inhalt - Contenido - Contenuto : 12 modèles - models - Modelle - modelos - modelli
10x MSA45.602 (Ø 1.00 mm) .603 (1.10) .604 (1.20) .607 (1.30) .608 (1.50) .700 (0.40) .704 (0.70) .707 (0.80) .709 (0.65)
.801 (0.20) .802 (0.25) .803 (0.17)



MSA	Qté. / Qty.	Kg
99.162	120x	0.026

Assortiment d'aiguilles noires pour montres ; heures, minutes et secondes au centre.
 Assortment of black hands for watches ; hours, minutes and centre seconds.
 Sortiment von schwarze Zeiger für Uhren ; Stunden, Minuten und Zentrumsekunden.
 Surtido de agujas negras para relojes ; horas, minutos y segundos centrales.
 Assortimento di lancette nere per orologi ; ore, minuti e secondi al centro.

Contenu - Contents - Inhalt - Contenido - Contenuto : 12 modèles - models - Modelle - modelos - modelli
10x MSA45.500 (Ø 0.40 mm) .501 (0.50) .505 (0.70) .508 (0.90) .509 (0.65) .850 (0.18) .852 (0.25) .853 (0.17) .900 (0.80)
.901 (0.90) .902 (1.00) .904 (1.20)



Heures - Hours - Stunden - Horas - Ore

Aiguille lumineuse pour montres emballées sur carte, 10 pièces.
 Luminous hand for watches packed on card, 10 pieces.
 Leuchtzeiger für Uhren auf Karte verpackt, 10 Stück.
 Aguja luminosa para relojes embaladas en tarjeta, 10 piezas.
 Lancetta luminosa per orologi imballate su carta, 10 pezzi.

Couleur/Colour : Nickel/Nickel

MSA	Ø trou mm Ø hole mm	L mm	Kg
45.210	1.00	6.00	0.004
45.211	1.00	8.00	0.004
45.212	1.10	6.00	0.004
45.213	1.10	8.00	0.004
45.214	1.20	6.00	0.004
45.215	1.20	8.00	0.004
45.216	1.20	10.00	0.004
45.217	1.50	8.00	0.004
45.218	1.50	10.00	0.004
45.221	2.00	8.00	0.004
45.219	2.00	8.50	0.004
45.220	2.00	10.00	0.004

Couleur/Colour : Jaune/Yellow

MSA	Ø trou mm Ø hole mm	L mm	Kg
45.610	1.00	6.00	0.004
45.611	1.00	8.00	0.004
45.612	1.10	6.00	0.004
45.613	1.10	8.00	0.004
45.614	1.20	6.00	0.004
45.615	1.20	8.00	0.004
45.616	1.20	10.00	0.004
45.617	1.50	8.00	0.004
45.618	1.50	10.00	0.004
45.621	2.00	8.00	0.004
45.619	2.00	8.50	0.004
45.620	2.00	10.00	0.004



Minutes - Minutes - Minuten - Minutos - Minuti

Aiguille lumineuse pour montres emballées sur carte, 10 pièces.
 Luminous hand for watches packed on card, 10 pieces.
 Leuchtzeiger für Uhren auf Karte verpackt, 10 Stück.
 Aguja luminosa para relojes embaladas en tarjeta, 10 piezas.
 Lancetta luminosa per orologi imballate su carta, 10 pezzi.

Couleur/Colour : Nickel/Nickel

Couleur/Colour : Jaune/Yellow



**Secondes - Seconds - Sekunden -
 Segunderos - Secondi**

Couleur/Colour : Nickel/Nickel

Aiguille lumineuse pour montres emballées sur carte, 10 pièces.
 Luminous hand for watches packed on card, 10 pieces.
 Leuchtzeiger für Uhren auf Karte verpackt, 10 Stück.
 Aguja luminosa para relojes embaladas en tarjeta, 10 piezas.
 Lancetta luminosa per orologi imballate su carta, 10 pezzi.

Couleur/Colour : Jaune/Yellow



MSA	Qté. / Qty.	Kg
99.169	60x	0.026

Assortiment d'aiguilles lumineuses couleur nickel pour montres ; heures, minutes et secondes.
 Assortment of nickel colour luminous hands for watches ; hours, minutes and seconds.
 Sortiment von Nickel-Farbe Leuchtzeiger für Uhren ; Stunden, Minuten und Sekunden.
 Surtido de agujas luminosas color níquel para relojes ; horas, minutos y segunderos.
 Assortimento di lancette luminose colore nichel per orologi ; ore, minuti e secondi.

Contenu - Contents - Inhalt - Contenido - Contenuto : 12 modèles - models - Modelle - modelos - modelli
5x MSA45.211 (Ø 1.00 mm) .213 (1.10) .214 (1.20) .215 (1.20) .216 (1.20) .311 (0.55) .313 (0.60) .314 (0.70) .315 (0.70)
.316 (0.70) .406 (0.20) .407 (0.22)



MSA	Qté. / Qty.	Kg
99.170	60x	0.026

Assortiment d'aiguilles lumineuses couleur nickel pour montres ; heures, minutes et secondes.
 Assortment of nickel colour luminous hands for watches ; hours, minutes and seconds.
 Sortiment von Nickel-Farbe Leuchtzeiger für Uhren ; Stunden, Minuten und Sekunden.
 Surtido de agujas luminosas color níquel para relojes ; horas, minutos y segunderos.
 Assortimento di lancette luminose colore nichel per orologi ; ore, minuti e secondi.

Contenu - Contents - Inhalt - Contenido - Contenuto : 12 modèles - models - Modelle - modelos - modelli
5x MSA45.217 (Ø 1.50 mm) .218 (1.50) .219 (2.00) .220 (2.00) .221 (2.00) .317 (0.90) .318 (0.90) .319 (1.20) .321 (1.50)
.322 (1.50) .409 (0.23) .411 (0.25)



MSA	Qté. / Qty.	Kg
99.167	60x	0.026

Assortiment d'aiguilles lumineuses jaunes pour montres ; heures, minutes et secondes.
 Assortment of yellow luminous hands for watches ; hours, minutes and seconds.
 Sortiment von gelbe Leuchtzeiger für Uhren ; Stunden, Minuten und Sekunden.
 Surtido de agujas luminosas amarillas para relojes ; horas, minutos y segunderos.
 Assortimento di lancette luminose gialle per orologi ; ore, minuti e secondi.

Contenu - Contents - Inhalt - Contenido - Contenuto : 12 modèles - models - Modelle - modelos - modelli
5x MSA45.611 (Ø 1.50 mm) .613 (1.10) .614 (1.20) .615 (1.20) .616 (1.20) .711 (0.55) .713 (0.60) .714 (0.70) .715 (0.70)
.716 (0.70) .806 (0.20) .807 (0.22)

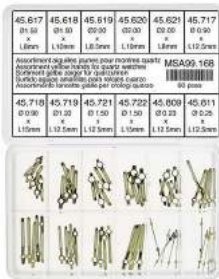

MSA	Qté. / Qty.	Kg
99.168	60x	0.026

Assortiment d'aiguilles lumineuses jaunes pour montres ; heures, minutes et secondes.
 Assortment of yellow luminous hands for watches ; hours, minutes and seconds.
 Sortiment von gelbe Leuchtzeiger für Uhren ; Stunden, Minuten und Sekunden.
 Surtido de agujas luminosas amarillas para relojes ; horas, minutos y segundos.
 Assortimento di lancette luminose gialle per orologi ; ore, minuti e secondi.

Contenu - Contents - Inhalt - Contenido - Contenuto : 12 modèles - models - Modelle - modelos - modelli
5x MSA45.617 (Ø 1.50 mm) .618 (1.50) .619 (2.00) .620 (2.00) .621 (2.00) .717 (0.90) .718 (0.90) .719 (1.20) .721 (1.50)
.722 (1.50) .809 (0.23) .811 (0.25)



Aiguille de compteur pour montres emballées sur carte, 10 pièces.
 Counter hand for watches packed on card, 10 pieces.
 Zählzeiger für Uhren auf Karte verpackt, 10 Stück.
 Aguja de contador para relojes embaladas en tarjeta, 10 piezas.
 Lancetta del contatore per orologi imballate su carta, 10 pezzi.

Compteur - Counter - Zähler -
Contador - Contatore
Tube - Tube - Rohr - Tubo - Tubo = 0.75 mm

Couleur/Colour : Nickel/Nickel

Couleur/Colour : Jaune/Yellow

Couleur/Colour : Noir/Black



Aiguille de compteur pour montres emballées sur carte, 10 pièces.
 Counter hand for watches packed on card, 10 pieces.
 Zählzeiger für Uhren auf Karte verpackt, 10 Stück.
 Aguja de contador para relojes embaladas en tarjeta, 10 piezas.
 Lancetta del contatore per orologi imballate su carta, 10 pezzi.

Compteur - Counter - Zähler -
Contador - Contatore
Tube - Tube - Rohr - Tubo - Tubo = 1.40 mm

Couleur/Colour : Nickel/Nickel

Couleur/Colour : Jaune/Yellow

Couleur/Colour : Noir/Black



Assortiment d'aiguilles de compteur pour montres ; couleur nickel et jaunes.
 Assortment of counter hands for watches ; nickel colour and yellow.
 Sortiment von Zählzeiger für Uhren ; Nickel-Farbe und gelbe.
 Surtido de agujas de contador para relojes ; color níquel y amarillas.
 Assortimento di lancette del contatore per orologi ; colore nichel e gialle.

Contenu - Contents - Inhalt - Contenido - Contenuto : 18 modèles - models - Modelle - modelos - modelli
 5x MSA45.040 (Ø 0.17 mm) .041 (0.18) .042 (0.20) .043 (0.21) .044 (0.22) .045 (0.23) .046 (0.25) .047 (0.28) .048 (0.30)
 .150 (0.17) .151 (0.18) .152 (0.20) .153 (0.21) .154 (0.22) .155 (0.23) .156 (0.25) .157 (0.28) .158 (0.30)



Assortiment d'aiguilles de compteur pour montres ; couleur nickel et jaunes.
 Assortment of counter hands for watches ; nickel colour and yellow.
 Sortiment von Zählzeiger für Uhren ; Nickel-Farbe und gelbe.
 Surtido de agujas de contador para relojes ; color níquel y amarillas.
 Assortimento di lancette del contatore per orologi ; colore nichel e gialle.

Contenu - Contents - Inhalt - Contenido - Contenuto : 18 modèles - models - Modelle - modelos - modelli
 5x MSA45.240 (Ø 0.17 mm) .241 (0.18) .242 (0.20) .243 (0.21) .244 (0.22) .245 (0.23) .246 (0.25) .247 (0.28) .248 (0.30)
 .180 (0.17) .181 (0.18) .182 (0.20) .183 (0.21) .184 (0.22) .185 (0.23) .186 (0.25) .187 (0.28) .188 (0.30)



Assortiment d'aiguilles de compteur noires pour montres.
 Assortment of black counter hands for watches.
 Sortiment von schwarze Zählzeiger für Uhren.
 Surtido de agujas de contador negras para relojes.
 Assortimento di lancette del contatore nere per orologi.

Contenu - Contents - Inhalt - Contenido - Contenuto : 18 modèles - models - Modelle - modelos - modelli
 0.75 mm : 5x MSA45.170 (Ø 0.17 mm) .171 (0.18) .172 (0.20) .173 (0.21) .174 (0.22) .175 (0.23) .176 (0.25) .177 (0.28)
 .178 (0.30)
 1.40 mm : 5x MSA45.250 (Ø 0.17 mm) .251 (0.18) .252 (0.20) .253 (0.21) .254 (0.22) .255 (0.23) .256 (0.25) .257 (0.28)
 .258 (0.30)



Heures - Hours - Stunden - Horas - Ore

Aiguille bleue pour montres de poche anciennes emballées sur carte, 10 pièces.
 Blue hand for old pocket watches packed on card, 10 pieces.
 Blauer Zeiger für alte Taschenuhren auf Karte verpackt, 10 Stück.
 Aguja azul para relojes de bolsillo antiguos embaladas en tarjeta, 10 piezas.
 Lancetta blu per orologi da tasca antichi imballate su carta, 10 pezzi.



Minutes - Minuten - Minuten - Minutos - Minuti

Aiguille bleue pour montres de poche anciennes emballées sur carte, 10 pièces.
 Blue hand for old pocket watches packed on card, 10 pieces.
 Blauer Zeiger für alte Taschenuhren auf Karte verpackt, 10 Stück.
 Aguja azul para relojes de bolsillo antiguos embaladas en tarjeta, 10 piezas.
 Lancetta blu per orologi da tasca antichi imballate su carta, 10 pezzi.



Petites secondes - Small seconds - Kleine Sekunden - Pequeños segundos - Piccoli secondi

Aiguille bleue pour montres de poche anciennes emballées sur carte, 10 pièces.
 Blue hand for old pocket watches packed on card, 10 pieces.
 Blauer Zeiger für alte Taschenuhren auf Karte verpackt, 10 Stück.
 Aguja azul para relojes de bolsillo antiguos embaladas en tarjeta, 10 piezas.
 Lancetta blu per orologi da tasca antichi imballate su carta, 10 pezzi.

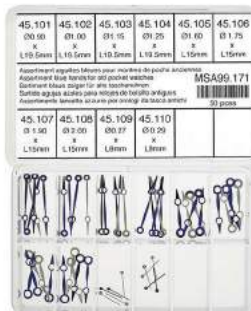

Assortiment d'aiguilles bleues pour montres de poche anciennes; heures, minutes et petites secondes.
 Assortment of blue hands for old pocket watches ; hours, minutes and small seconds.
 Sortiment von blaue Zeiger für alte Taschenuhren ; Stunden, Minuten und kleine Sekunden.
 Surtido de agujas azules para relojes de bolsillo antiguos ; horas, minutos y pequeños segundos.
 Assortimento di lancette azzurre per orologi da tasca antichi ; ore, minuti e piccoli secondi.

Contenu - Contents - Inhalt - Contenido - Contenuto : 10 modèles - models - Modelle - modelos - modelli
 5x MSA45.101 (Ø 0.90 mm) .102 (1.00) .103 (1.15) .104 (1.25) .105 (1.60) .106 (1.75) .107 (1.90) .108 (2.00) .109 (0.27) .110 (0.29)



Heures - Hours - Stunden - Horas - Ore

Aiguille rose de forme Dague pour montres anciennes emballées sur carte, 10 pièces.
 Dagger-shaped pink hand for old watches packed on card ; hours, minutes and centre seconds.
 Rosa Zeiger in Dolch-Form für alte Uhren auf Karte verpackt ; Stunden, Minuten und Zentrumsekunden.
 Aguja rosada de forma Daga para relojes antiguos embaladas en tarjeta ; horas, minutos y segunderos centrales.
 Lancetta rosa di forma Daga per orologi antichi imballate su carta ; ore, minutie secondi al centro.



Minutes - Minutes - Minuten - Minutos - Minuti

Aiguille rose de forme Dague pour montres anciennes emballées sur carte, 10 pièces.
 Dagger-shaped pink hand for old watches packed on card, 10 pieces.
 Rosa Zeiger in Dolch-Form für alte Uhren auf Karte verpackt, 10 Stück.
 Aguja rosada de forma Daga para relojes antiguos embaladas en tarjeta, 10 piezas
 Lancetta rosa di forma Daga per orologi antichi imballate su carta, 10 pezzi.



Seconde au centre - Centre second - Zentrumsekunden - Segundero central - Secondi al centro

Aiguille rose de forme Dague pour montres anciennes emballées sur carte, 10 pièces.
 Dagger-shaped pink hand for old watches packed on card, 10 pieces.
 Rosa Zeiger in Dolch-Form für alte Uhren auf Karte verpackt, 10 Stück.
 Aguja rosada de forma Daga para relojes antiguos embaladas en tarjeta, 10 piezas
 Lancetta rosa di forma Daga per orologi antichi imballate su carta, 10 pezzi.



Assortiment d'aiguilles roses de forme Dague pour montres anciennes ; heures, minutes et secondes au centre.
 Assortment of Dagger-shaped pink hands for old watches ; hours, minutes and centre seconds.
 Sortiment von Rose Zeiger in Dolch-Form für alte Uhren ; Stunden, Minuten und Zentrumsekunden.
 Surtido de agujas rosadas de forma Daga para relojes antiguos ; horas, minutos y segunderos centrales.
 Assortimento di lancette rosa di forma Daga per orologi antichi ; ore, minuti e secondi al centro.

Contenu - Contents - Inhalt - Contenido - Contenuto : 12 modèles - models - Modelle - modelos - modelli
 5x MSA45.121 (Ø 0.70 mm) .122 (0.75) .123 (0.80) .124 (0.85) .126 (1.20) .127 (1.30) .129 (1.40) .130 (1.50) .131 (0.20)
 .134 (0.25) .135 (0.28) .136 (0.30)

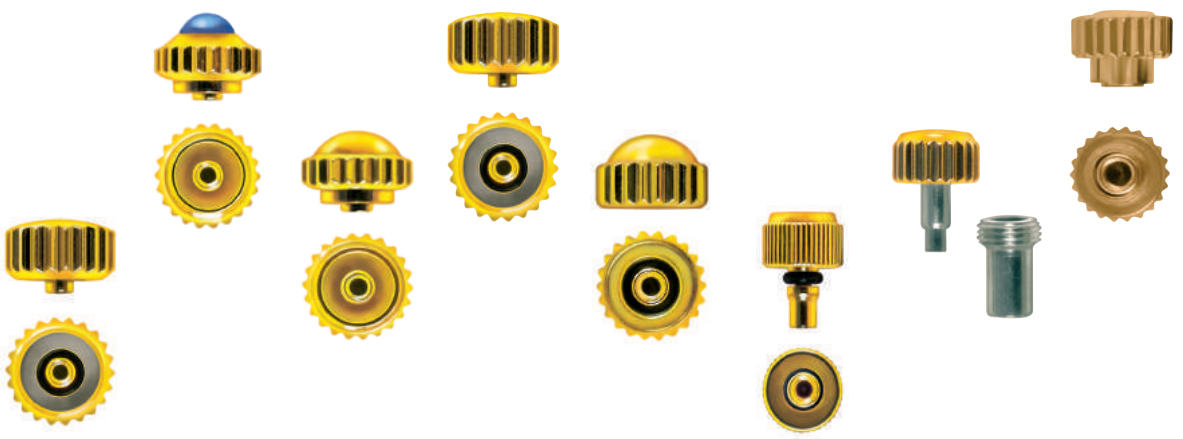

COURONNES CROWNS KRONEN CORONAS CORONE COROAS

Couronnes simples
Regular crowns
 Einfache Kronen
Coronas sencillas
 Corone semplici
Coroas simples



4

Couronnes antipoussière
Dustproof crowns
 Staubgeschützte Kronen
Coronas antipolvo
 Corone antipolvere
Coroas anti-poeira

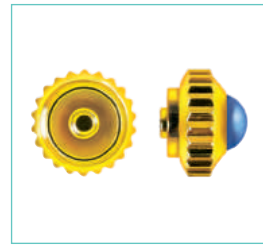

8

Couronnes antipoussière demi-boule
Dustproof domed crowns
 Staubgeschützte Halbkugelkronen
Coronas antipolvo media bola
 Corone antipolvere demiboule
Coroas anti-poeira meia bola

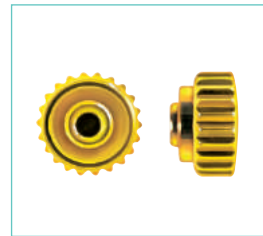

12

Couronnes étanches
Waterproof crowns
 Wasserdichte Kronen
Coronas herméticas
 Corone impermeabili
Coroas estanques

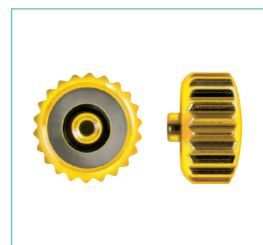

14

34

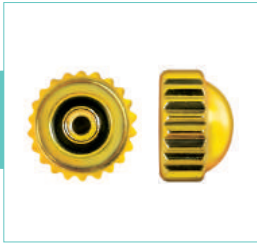

Couronnes étanches demi-boule
Waterproof domed crowns
Wasserdichte Halbkugel Kronen
Coronas herméticas media bola
Corone impermeabili demiboule
Coroas estanques meia bola

39



Couronnes japonaises
Japanese crowns
Japanische Kronen
Coronas japonesas
Corone giapponesi
Coroas japonesas

47

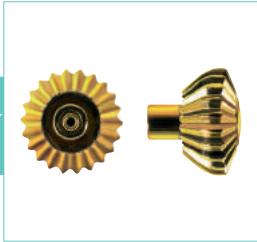

Couronnes pour montres de poche
Pocket watches crowns
Kronen für Taschenuhren
Coronas para relojes de bolsillo
Corone per orologi da tasca
Coroas para relógios de bolso

Couronnes à vis
Screw-on crowns
Schraubkronen
Coronas de rosca
Corone a vite
Coroas de rosca



51

Couronnes de marque
Brand crowns
Markenkronen
Coronas de marca
Corone di marca
Coroas de marca

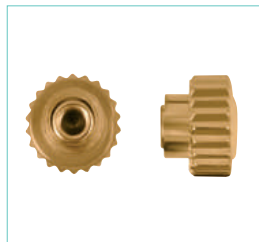

66



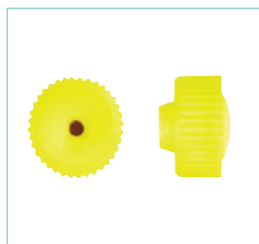













Couronnes de travail
Working crowns
Arbeitskronen
Coronas de trabajo
Corone di lavoro
Coroas de trabalho



71



Couronne simple couleur acier et jaune, **canon court** ; acier inoxydable.
 Steel colour and yellow regular crown, **short pipe** ; stainless steel.
 Stahlfarbe und gelbe einfache Krone, **kurzes Rohr** ; Edelstahl.
 Corona sencilla color acero y amarilla, **cañón corto** ; acero inoxidable.
 Corona semplice colore acciaio e gialla, **cannotto corto** ; acciaio inossidabile.
 Coroa simples cor aço e amarela, **canhão curto** ; aço inoxidável.

MSA	Couleur acier/Steel colour	Ø mm	Ø Tar./Tap. mm	MSA	Jaune/Yellow
82.001-070*		2.50	0.70	82.201-070*	
82.001-080*		2.50	0.80	82.201-080*	
82.001-090*		2.50	0.90	82.201-090	
82.002-070		3.00	0.70	82.202-070*	
82.002-080		3.00	0.80	82.202-080	
82.002-090		3.00	0.90	82.202-090	
82.003-070		3.50	0.70	82.203-070*	
82.003-080		3.50	0.80	82.203-080*	
82.003-090		3.50	0.90	82.203-090	
82.004-090		3.80	0.90	82.204-090	
82.005-090		4.00	0.90	82.205-090	
82.006-090		4.50	0.90	82.206-090	
82.007-090		5.00	0.90	82.207-090	
-		5.50	0.70	82.208-070*	
82.008-090		5.50	0.90	82.208-090	

Kg 0.001 * Jusqu'à épuisement des stocks / Will be discontinued after end of stock / Solange Vorrat /
 Hasta agotamiento del stock / Fino ad esaurimento dello stock / Até esgotamento do stock

1/1



Couronne simple, **canon court** ; laiton nickelé.
 Regular crown, **short pipe** ; nickel-plated brass.
 Einfache Krone, **kurzes Rohr** ; vernickeltem Messing.
 Corona sencilla, **cañón corto** ; latón niquelado.
 Corona semplice, **cannotto corto** ; ottone nichelato.
 Coroa simples, **canhão curto** ; latão niquelado.

MSA	1/1	Ø mm	Ø T mm
82.009-120		5.00	1.20

Kg 0.001

1/1

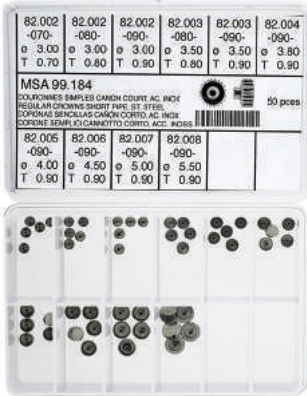

Assortiment de couronnes simples couleur acier, **canon court** ; acier inoxydable.
Assortiment of steel colour regular crowns, **short pipe** ; stainless steel.
Sortiment von Stahlfarbe einfache Kronen, **kurzes Rohr** ; Edelstahl.
Sortido de coronas sencillas color acero, **cañón corto** ; acero inoxidable.
Assortimento di corone semplici colore acciaio, **cannotto corto** ; acciaio inossidabile.
Sortido de coroas simples cor aço, **canhão curto** ; aço inoxidável.

MSA	Qt.	Kg
99.184	50x	0.028

**Contenu - Contents - Inhalt - Contenido - Contenuto - Conteúdo :
10 modèles - models - Modelle - modelos - modelli - modelos
5x MSA82.002-070 /.002-080 /.002-090 /.003-080 /.003-090
/.004-090 /.005-090 /.006-090 /.007-090 /.008-090**



















Assortiment de couronnes simples jaunes, **canon court** ; acier inoxydable.
Assortiment of yellow regular crowns, **short pipe** ; stainless steel.
Sortiment von gelbe einfache Kronen, **kurzes Rohr** ; Edelstahl.
Sortido de coronas sencillas amarillas, **cañón corto** ; acero inoxidable.
Assortimento di corone semplici gialle, **cannotto corto** ; acciaio inossidabile.
Sortido de coroas simples amarelas, **canhão curto** ; aço inoxidável.

MSA	Qt.	Kg
99.185	45x	0.028

**Contenu - Contents - Inhalt - Contenido - Contenuto - Conteúdo :
9 modèles - models - Modelle - modelos - modelli - modelos
5x MSA82.201-090 /.202-080 /.202-090 /.203-090 /.204-090
/.205-090 /.206-090 /.207-090 /.208-090**



Couronne simple couleur acier et jaune, **canon long** ; acier inoxydable.
 Steel colour and yellow regular crown, **long pipe** ; stainless steel.
 Stahlfarbe und gelbe einfache Krone, **langes Rohr** ; Edelstahl.
 Corona sencilla color acero y amarilla, **cañón largo** ; acero inoxidable.
 Corona semplice colore acciaio e gialla, **cannotto lungo** ; acciaio inossidabile.
 Coroa simples cor aço e amarela, **canhão longo** ; aço inoxidável.

MSA	Couleur acier/Steel colour	Ø mm	Ø Tar./Tap. mm	MSA	Jaune/Yellow
82.051-070*		2.50	0.70	82.251-070*	
82.051-080*		2.50	0.80	82.251-080*	
82.051-090		2.50	0.90	82.251-090	
82.052-070*		3.00	0.70	82.252-070*	
82.052-080*		3.00	0.80	82.252-080*	
82.052-090		3.00	0.90	82.252-090	
82.053-070*		3.50	0.70	82.253-070*	
82.053-080*		3.50	0.80	82.253-080*	
82.053-090		3.50	0.90	82.253-090	
82.054-090		3.80	0.90	82.254-090	
82.055-090		4.00	0.90	82.255-090	
82.056-090		4.50	0.90	82.256-090	
82.057-090		5.00	0.90	82.257-090	
82.058-090		5.50	0.90	82.258-090	

Kg 0.001

* Jusqu'à épuisement des stocks / Will be discontinued after end of stock / Solange Vorrat /
 Hasta agotamiento del stock / Fino ad esaurimento dello stock / Até esgotamento do stock

1/1

82.051 -090- ø 2.50 T 0.90	82.052 +090- ø 3.00 T 0.90	82.053 -090- ø 3.50 T 0.90	82.054 -090- ø 3.80 T 0.90	82.055 -090- ø 4.00 T 0.90	82.056 -090- ø 4.50 T 0.90
MSA 99.182 COURONNES SIMPLES CANON LONG, AC. INOX. REGULAR CROWN LONG PIPE, ST. STEEL. CORONAS SENCILLAS CANON LARGO, AC. INOX. CORONE SEMPLICI CANNOTTO LUNGO, ACC. INOSSI. COROAS SIMPLES CANHO LONGO, AÇO INOXID. 40 pcs					
82.057 -090- ø 5.00 T 0.90	82.058 -090- ø 5.50 T 0.90				



MSA	Qt.	Kg
99.182	40x	0.028

Assortiment de couronnes simples couleur acier, **canon long** ; acier inoxydable.

Assortiment of steel colour regular crowns, **long pipe** ; stainless steel.

Sortiment von Stahlfarbe einfache Kronen, **langes Rohr** ; Edelstahl.

Surtido de coronas sencillas en acero inoxidable, **cañón largo** ; color acero.

Assortimento di corone semplici in acciaio inossidabile, **cannotto lungo** ; colore acciaio.

Sortido de coroas simples em aço inoxidável, **canhão longo** ; cor aço.

**Contenu - Contents - Inhalt - Contenido - Contenuto - Conteúdo :
8 modèles - models - Modelle - modelos - modelli - modelos
5x MSA82.051-090 /.052-090 /.053-090 /.054-090 /.055-090
/.056-090 /.057-090 /.058-090**

82.251 -090- ø 2.50 T 0.90	82.252 -090- ø 3.00 T 0.90	82.253 -090- ø 3.50 T 0.90	82.254 -090- ø 3.80 T 0.90	82.255 -090- ø 4.00 T 0.90	82.256 -090- ø 4.50 T 0.90
MSA 99.181 COURONNES SIMPLES CANON LONG JAUNES REGULAR CROWNS LONG PIPE, YELLOW CORONAS SENCILLAS CANON LARGO, AMARILLAS CORONE SEMPLICI CANNOTTO LUNGO, GIALLE COROAS SIMPLES CANHO LONGO, AMARELAS 40 pcs					
82.257 -090- ø 5.00 T 0.90	82.258 -090- ø 5.50 T 0.90				



MSA	Qt.	Kg
99.181	40x	0.028

Assortiment de couronnes simples jaunes, **canon long** ; acier inoxydable.

Assortiment of yellow regular crowns, **long pipe** ; stainless steel.

Sortiment von gelbe einfache Kronen, **langes Rohr** ; Edelstahl.

Surtido de coronas sencillas amarillas, **cañón largo** ; acero inoxidable.

Assortimento di corone semplici gialle, **cannotto lungo** ; acciaio inossidabile.

Sortido de coroas simples amarelas, **canhão longo** ; aço inoxidável.

**Contenu - Contents - Inhalt - Contenido - Contenuto - Conteúdo :
8 modèles - models - Modelle - modelos - modelli - modelos
5x MSA82.251-090 /.252-090 /.253-090 /.254-090 /.255-090
/.256-090 /.257-090 /.258-090**



Couronne antipoussière jaune avec pierre bleue ou noire ; acier inoxydable.
 Yellow dustproof crown with blue or black stone ; stainless steel.
 Gelbe staubgeschützte Krone mit blauem oder schwarzem Stein ; Edelstahl.
 Corona antipolvo amarilla con piedra azul o negra ; acero inoxidable.
 Corona antipolvere gialla con pietra blu o nera ; acciaio inossidabile.
 Coroa anti-poeira amarela com pedra azul ou preta ; aço inoxidável.

MSA	Pierre bleue/Blue stone	Ø mm	Ø Tar./Tap. mm	MSA	Pierre noire/Black stone
83.252-090		3.00	0.90	83.272-090	
83.253-090		3.50	0.90	83.273-090	
83.254-090		3.80	0.90	83.274-090	
83.255-090		4.00	0.90	83.275-090	
83.256-090		4.50	0.90	83.276-090	
83.257-090		5.00	0.90	83.277-090	

Kg 0.001

1/1

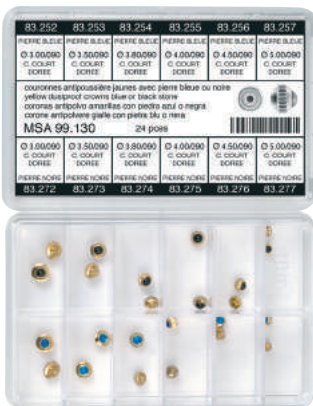

Assortiment de couronnes antipoussière jaunes avec pierre bleue ou noire ; acier inoxydable.
 Assortment of yellow dustproof crowns with blue or black stone ; stainless steel.
 Sortiment von gelbe staubgeschützte Kronen mit blauem oder schwarzem Stein ; Edelstahl.
 Surtido de coronas antipolvo amarillas con piedra azul o negra ; acero inoxidable.
 Assortimento di corone antipolvere gialle con pietra blu o nera ; acciaio inossidabile.
 Sortido de coroas anti-poeira amarelas com pedra azul ou preta ; aço inoxidável.

MSA	Qt.	Kg
99.130	24x	0.025

Contenu - Contents - Inhalt - Contenido - Contenuto - Conteúdo :
12 modèles - models - Modelle - modelos - modelli - modelos
2x MSA83.252-090 /.253-090 /.254-090 /.255-090 /.256-090
/.257-090 /.272-090 /.273-090 /.274-090 /.275-090 /.276-090
/.277-090



Couronne antipoussière couleur acier et jaune avec pierre bleue ou bleu foncé ; acier inoxydable.

Steel colour and yellow dustproof crown with blue or dark blue stone ; stainless steel.

Stahlfarbe und gelbe staubgeschützte Krone mit blauem oder dunkelblauem Stein ; Edelstahl.

Corona antipolvo color acero y amarilla con piedra azul o azul oscuro ; acero inoxidable.

Corona antipolvere colore acciaio e gialla con pietra blu o blu scuro ; acciaio inossidabile.

Coroa anti-poeira cor aço e amarela com pedra azul ou azul escuro ; aço inoxidável.

MSA	Couleur acier/Steel colour	Ø mm	Ø Tar./Tap. mm	Pierre/Stone	MSA	Jaune/Yellow
83.403		4.25	0.90	Bleu/Blue	-	-
83.401		4.35	0.90	Bleu foncé/Dark blue	83.451	
83.405		4.45	0.90	Bleu/Blue	83.453	
83.402		4.45	0.90	Bleu foncé/Dark blue	83.452	
83.404		4.75	0.90	Bleu/Blue	-	-

Kg 0.001

1/1

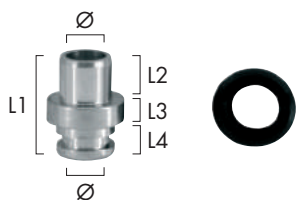

Tube spécial en acier inoxydable pour couronnes, avec joint MSA43.006.

Stainless steel special crown tube, with gasket MSA43.006.

Spezieller Rohr aus Edelstahl für Kronen, mit Dichtung MSA43.006.

Tubo especial en acero inoxidable para coronas, con junta MSA43.006.

Tubo speciale in acciaio inossidabile per corone, con guarnizione MSA43.006.

Tubo especial em aço inoxidável para coroas, com junta MSA43.006.

MSA	Ø int. mm	L1 mm	L2 mm	L3 mm	L4 mm	Kg
47.101	1.27	2.50	1.00	0.29	1.21	0.001

10
pcs

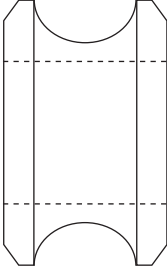

Joint pour tube spécial en acier inoxydable MSA47.101 ; sachet de 10 pièces.
 Gasket for stainless steel special tube MSA47.101 ; bag of 10 pieces.
 Dichtung für spezieller Rohr aus Edelstahl MSA47.101 ; Beutel von 10 Stück.
 Junta para tubo especial en acero inoxidable MSA47.101 ; bolsita de 10 piezas.
 Guarnizione per tubo speciale in acciaio inossidabile MSA47.101 ; bustina da 10 pezzi.
 Junta para tubo especial em aço inoxidável MSA47.101 ; saquinho de 10 peças.

MSA	1/1	Ø int./ext. mm	Kg
43.006	○	1.50 x 2.80	0.001

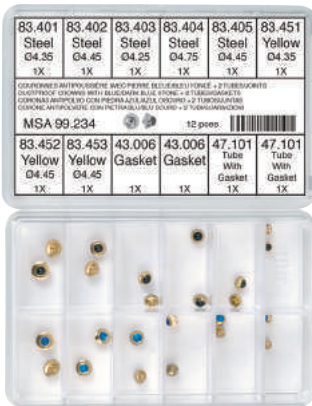

Assortiment de couronnes antipoussière couleur acier et jaunes avec pierre bleue ou bleu foncé, 2 tubes et 2 joints ; acier inoxydable.
 Assortment of steel colour and yellow dustproof crowns with blue or dark blue stone, 2 tubes and 2 gaskets ; stainless steel.
 Sortiment von Stahlfarbe und gelbe staubgeschützte Kronen mit blauem oder dunkelblauem Stein, 2 Röhre und 2 Dichtungen ; Edelstahl.
 Surtido de coronas antipolvo color acero y amarillas con piedra azul o azul oscuro, 2 tubos y 2 juntas ; acero inoxidable.
 Assortimento di corone antipolvere colore acciaio e gialle con pietra blu o blu scuro, 2 tubi e 2 guarnizioni ; acciaio inossidabile.
 Sortido de coroas anti-poeira cor aço e amarelas com pedra azul ou azul escuro, 2 tubos e 2 juntas ; aço inoxidável.

MSA	Qt.	Kg
99.234	8x	0.025

Contenu - Contents - Inhalt - Contenido - Contenuto - Conteúdo :
8 modèles - models - Modelle - modelos - modelli - modelos
1xMSA83.401 /.402 /.403 /.404 /.405 /.451 /.452 /.453
2x MSA43.006 /47.101



Couronne antipoussière couleur acier et jaune ; acier inoxydable.
 Steel colour and yellow dustproof crown ; stainless steel.
 Stahlfarbe und gelbe staubgeschützte Krone ; Edelstahl.
 Corona antipolvo color acero y amarilla ; acero inoxidable.
 Corona antipolvere colore acciaio e gialla ; acciaio inossidabile.
 Coroa anti-poeira cor aço e amarela ; aço inoxidável.

MSA	Couleur acier/Steel colour	Ø mm	Ø Tar./Tap. mm	MSA	Jaune/Yellow
83.302-090		3.00	0.90	83.202-090	
83.303-090		3.50	0.90	83.203-090	
83.304-090		3.80	0.90	83.204-090	
83.305-090		4.00	0.90	83.205-090	
83.306-090		4.50	0.90	83.206-090	
83.307-090		5.00	0.90	83.207-090	

Kg 0.001

1/1

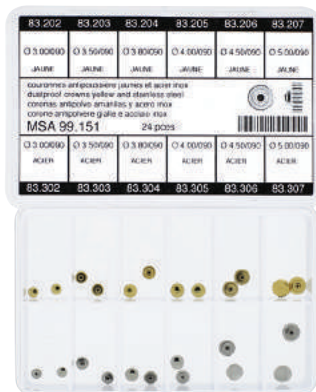

Assortiment de couronnes antipoussière couleur acier et jaunes ; acier inoxydable.
 Assortment of steel colour and yellow dustproof crowns ; stainless steel.
 Sortiment von Stahlfarbe und gelbe staubgeschützte Kronen ; Edelstahl.
 Surtido de coronas antipolvo color acero y amarillas ; acero inoxidable.
 Assortimento di corone antipolvere colore acciaio e gialle ; acciaio inossidabile.
 Sortido de coroas anti-poeira cor aço e amarelas ; aço inoxidável.

Contenu - Contents - Inhalt - Contenido - Contenuto - Conteúdo :
12 modèles - models - Modelle - modelos - modelli - modelos
2x MSA83.202-090 /.203-090 /.204-090 /.205-090 /.206-090
/.207-090 /.302-090 /.303-090 /.304-090 /.305-090 /.306-090
/.307-090

MSA	Qt.	Kg
99.151	24x	0.028



Couronne antipoussière couleur acier et jaune ; acier inoxydable.
Steel colour and yellow dustproof crown ; stainless steel.
 Stahlfarbe und gelbe staubgeschützte Krone ; Edelstahl.
Corona antipolvo color acero y amarilla ; acero inoxidable.
 Corona antipolvere colore acciaio e gialla ; acciaio inossidabile.
Coroa anti-poeira cor aço e amarela ; aço inoxidável.

MSA	Couleur acier/Steel colour	Ø mm	Ø Tar./Tap. mm	MSA	Jaune/Yellow
86.501		2.80	0.90	86.001	
86.502		3.00 Bas/Low	0.90	86.002	
86.503		3.00 Haut/High	0.90	86.003	
86.504		3.30	0.90	86.004	
86.505		3.50 Bas/Low	0.90	86.005	
86.506		3.50 Haut/High	0.90	86.006	
86.507		3.80	0.90	86.007	
86.508		4.00	0.90	86.008	
86.509		4.30	0.90	86.009	
86.510		4.50 Bas/Low	0.90	86.010	
86.511		4.50 Haut/High	0.90	86.011	
86.512		5.00	0.90	86.012	

Kg 0.001

1/1

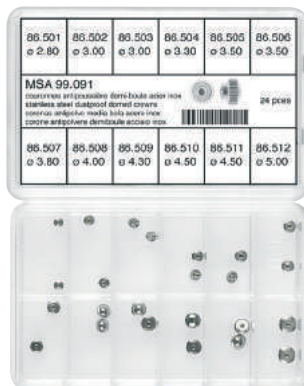

Assortiment de couronnes antipoussière couleur acier ; acier inoxydable.
 Assortment of steel colour dustproof crowns ; stainless steel.
 Sortiment von Stahlfarbe staubgeschützte Kronen ; Edelstahl.
 Surtido de coronas antipolvo color acero ; acero inoxidable.
 Assortimento di corone antipolvere colore acciaio ; acciaio inossidabile.
 Sortido de coroas anti-poeira cor aço ; aço inoxidável.

Contenu - Contents - Inhalt - Contenido - Contenuto - Conteúdo :
12 modèles - models - Modelle - modelos - modelli - modelos
2x MSA86.501 /.502 /.503 /.504 /.505 /.506 /.507 /.508 /.509
/.510 /.511 /.512

MSA	Qt.	Kg
99.091	24x	0.049









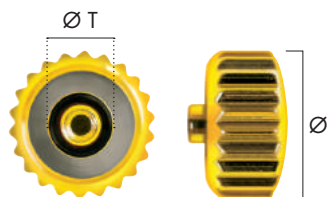























Assortiment de couronnes antipoussière jaunes ; acier inoxydable.
 Assortment of yellow dustproof crowns ; stainless steel.
 Sortiment von gelbe staubgeschützte Kronen ; Edelstahl.
 Surtido de coronas antipolvo amarillas ; acero inoxidable.
 Assortimento di corone antipolvere gialle ; acciaio inossidabile.
 Sortido de coroas anti-poeira amarelas ; aço inoxidável





























Contenu - Contents - Inhalt - Contenido - Contenuto - Conteúdo :
12 modèles - models - Modelle - modelos - modelli - modelos
2x MSA86.001 /.002 /.003 /.004 /.005 /.006 /.007 /.008 /.009
/.010 /.011 /.012





























MSA	Qt.	Kg
99.090	24x	0.049













Couronne étanche couleur acier et jaune, **canon court** ; acier inoxydable.
 Steel colour and yellow waterproof crown, **short pipe** ; stainless steel.
 Stahlfarbe und gelbe wasserdichte Krone, **kurzes Rohr** ; Edelstahl.
 Corona hermética color acero y amarilla, **cañón corto** ; acero inoxidable.
 Corona impermeabile colore acciaio e gialla, **canotto corto** ; acciaio inossidabile.
 Coroa estanque cor aço e amarela, **canhão curto** ; aço inoxidável.

MSA	Couleur acier/Steel colour	Ø mm	Ø T mm	Ø Tar./Tap. mm	MSA	Jaune/Noir Yellow/Black
84.302-070		3.00	1.60	0.70	84.202-070	
84.302-080		3.00	1.60	0.80	84.202-080	
84.302-090		3.00	1.60	0.90	84.202-090	
84.401-090		3.00	1.60	0.90	84.501-090	
84.312-070		3.00	1.80	0.70	84.212-070	
84.312-080		3.00	1.80	0.80	84.212-080	
84.312-090		3.00	1.80	0.90	84.212-090	
84.411-090		3.00	1.80	0.90	84.511-090	
84.303-070		3.50	1.60	0.70	84.203-070	
84.303-080		3.50	1.60	0.80	84.203-080	
84.303-090		3.50	1.60	0.90	84.203-090	
84.402-090		3.50	1.60	0.90	84.502-090	
84.313-070		3.50	1.80	0.70	84.213-070	
84.313-080		3.50	1.80	0.80	84.213-080	
84.313-090		3.50	1.80	0.90	84.213-090	
84.412-090		3.50	1.80	0.90	84.512-090	
84.323-070		3.50	2.00	0.70	84.223-070	
84.323-080		3.50	2.00	0.80	84.223-080	
84.323-090		3.50	2.00	0.90	84.223-090	
84.304-070		3.80	1.60	0.70	84.204-070	
84.304-080		3.80	1.60	0.80	84.204-080	
84.304-090		3.80	1.60	0.90	84.204-090	
84.324-070		3.80	2.00	0.70	84.224-070*	
84.324-080		3.80	2.00	0.80	84.224-080	
84.324-090		3.80	2.00	0.90	84.224-090	
84.403-090		4.00	1.60	0.90	84.503-090	
84.413-090		4.00	1.80	0.90	84.513-090	
84.325-070		4.00	2.00	0.70	84.225-070	
84.325-080		4.00	2.00	0.80	84.225-080	
84.325-090		4.00	2.00	0.90	84.225-090	
84.335-070		4.00	2.50	0.70	84.235-070*	
84.335-080		4.00	2.50	0.80	84.235-080*	
84.335-090		4.00	2.50	0.90	84.235-090	

MSA	Couleur acier/Steel colour	Ø mm	Ø T mm	Ø Tar./Tap. mm	MSA	Jaune/Noir Yellow/Black
84.404-090		4.50	1.60	0.90	84.504-090	
84.414-090		4.50	1.80	0.90	84.514-090	
84.326-090		4.50	2.00	0.90	84.226-090	
84.421-090		4.50	2.00	0.90	-	-
84.336-090		4.50	2.50	0.90	84.236-090	
84.441-090		4.50	2.50	0.90	-	-
84.405-090		5.00	1.60	0.90	84.505-090	
84.415-090		5.00	1.80	0.90	84.515-090	
84.327-090		5.00	2.00	0.90	84.227-090	
84.422-090		5.00	2.00	0.90	-	-
84.337-090		5.00	2.50	0.90	84.237-090	
84.442-090		5.00	2.50	0.90	-	-
84.406-090		5.50	1.60	0.90	84.506-090	
84.416-090		5.50	1.80	0.90	84.516-090	
84.423-090		5.50	2.00	0.90	-	-
84.339-090		5.50	2.50	0.90	84.239-090	
84.443-090		5.50	2.50	0.90	-	-
84.424-090		6.00	2.00	0.90	-	-
84.340-090		6.00	2.50	0.90	-	-
84.444-090		6.00	2.50	0.90	-	-
84.453-090		6.00	3.00	0.90	84.465-090	
84.475-090		6.00	3.50	0.90	84.485-090	
84.425-090		6.50	2.00	0.90	-	-
84.445-090		6.50	2.50	0.90	-	-
84.454-090		6.50	3.00	0.90	84.466-090	
84.476-090		6.50	3.50	0.90	84.486-090	
84.426-090		7.00	2.00	0.90	-	-
84.446-090		7.00	2.50	0.90	-	-

MSA	Couleur acier/Steel colour	Ø mm	Ø T mm	Ø Tar./Tap. mm	MSA	Jaune/Noir Yellow/Black
84.455-090		7.00	3.00	0.90	84.467-090	
84.477-090		7.00	3.50	0.90	84.487-090	
84.427-090		7.50	2.00	0.90	-	-
84.447-090		7.50	2.50	0.90	-	-
84.456-090		7.50	3.00	0.90	84.468-090	
84.478-090		7.50	3.50	0.90	84.488-090	
84.428-090		8.00	2.00	0.90	-	-
84.448-090		8.00	2.50	0.90	-	-
84.457-090		8.00	3.00	0.90	84.469-090	
84.479-090		8.00	3.50	0.90	84.489-090	
84.429-090		8.50	2.00	0.90	-	-
84.449-090		8.50	2.50	0.90	-	-
84.458-090		8.50	3.00	0.90	84.470-090	
84.480-090		8.50	3.50	0.90	84.490-090	
84.430-090		9.00	2.00	0.90	-	-
84.450-090		9.00	2.50	0.90	-	-
84.459-090		9.00	3.00	0.90	84.471-090	
84.481-090		9.00	3.50	0.90	84.491-090	
84.431-090		9.50	2.00	0.90	-	-

MSA	Couleur acier/Steel colour	Ø mm	Ø T mm	Ø Tar./Tap. mm	MSA	Jaune/Noir Yellow/Black
84.451-090		9.50	2.50	0.90	-	-
84.460-090		9.50	3.00	0.90	84.472-090	
84.482-090		9.50	3.50	0.90	84.492-090	
84.432-090		10.00	2.00	0.90	-	-
84.452-090		10.00	2.50	0.90	-	-
84.461-090		10.00	3.00	0.90	84.473-090	
84.483-090		10.00	3.50	0.90	84.493-090	

Kg 0.001 * Jusqu'à épuisement des stocks / Will be discontinued after end of stock / Solange Vorrat /
 Hasta agotamiento del stock / Fino ad esaurimento dello stock / Até esgotamento do stock

1/1

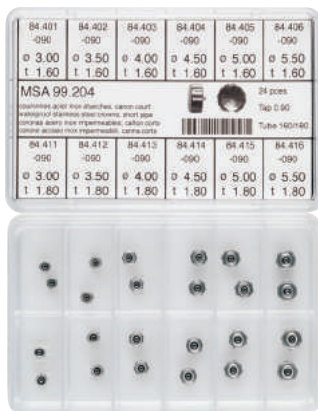

MSA	Qt.	Kg
99.204	24x	0.031

Ø T 1.60 - 1.80 mm

Assortiment de couronnes étanches couleur acier, **canon court** ; acier inoxydable.

Assortiment of steel colour waterproof crowns, **short pipe** ; stainless steel.

Sortiment von Stahlfarbe wasserdichte Kronen, **kurzes Rohr** ; Edelstahl.

Surtido de coronas herméticas color acero, **cañón corto** ; acero inoxidable.

Assortimento di corone impermeabili colore acciaio, **canotto corto** ; acciaio inossidabile.

Sortido de coroas estanques cor aço, **canhão curto** ; aço inoxidável.

**Contenu - Contents - Inhalt - Contenido - Contenuto - Conteúdo :
 12 modèles - models - Modelle - modelos - modelli - modelos
 2x MSA84.401-090 /.402-090 /.403-090 /.404-090 /.405-090
 /.406-090 /.411-090 /.412-090 /.413-090 /.414-090 /.415-090
 /.416-090**

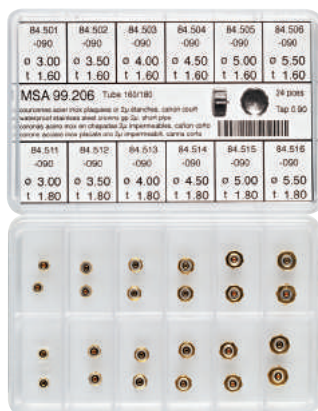

MSA	Qt.	Kg
99.206	24x	0.031

Ø T 1.60 - 1.80 mm

Assortiment de couronnes étanches jaunes, **canon court** ; acier inoxydable.

Assortiment of yellow waterproof crowns, **short pipe** ; stainless steel.

Sortiment von gelbe wasserdichte Kronen, **kurzes Rohr** ; Edelstahl.

Surtido de coronas herméticas amarillas, **cañón corto** ; acero inoxidable.

Assortimento di corone impermeabili gialle, **canotto corto** ; acciaio inossidabile.

Sortido de coroas estanques amarelas, **canhão curto** ; aço inoxidável.

**Contenu - Contents - Inhalt - Contenido - Contenuto - Conteúdo :
 12 modèles - models - Modelle - modelos - modelli - modelos
 2x MSA84.501-090 /.502-090 /.503-090 /.504-090 /.505-090
 /.506-090 /.511-090 /.512-090 /.513-090 /.514-090 /.515-090
 /.516-090**

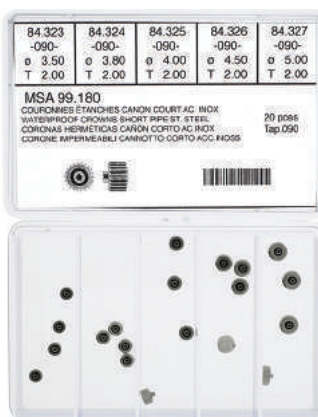

MSA	Qt.	Kg
99.180	20x	0.027

Ø T 2.00 mm

Assortiment de couronnes étanches couleur acier, **canon court** ; acier inoxydable.

Assortiment of steel colour waterproof crowns, **short pipe** ; stainless steel.

Sortiment von Stahlfarbe wasserdichte Kronen, **kurzes Rohr** ; Edelstahl.

Surtido de coronas herméticas color acero, **cañón corto** ; acero inoxidable.

Assortimento di corone impermeabili colore acciaio, **canotto corto** ; acciaio inossidabile.

Sortido de coroas estanques cor aço, **canhão curto** ; aço inoxidável.

**Contenu - Contents - Inhalt - Contenido - Contenuto - Conteúdo :
 5 modèles - models - Modelle - modelos - modelli - modelos
 4x MSA84.323-090 /.324-090 /.325-090 /.326-090 /.327-090**

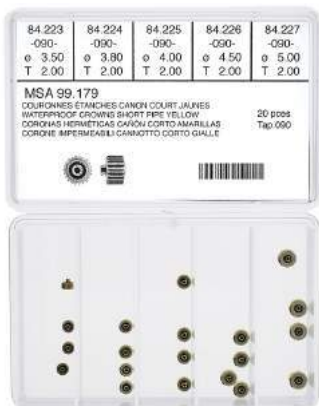

MSA	Qt.	Kg
99.179	20x	0.027

Ø T 2.00 mm

Assortiment de couronnes étanches jaunes, **canon court** ; acier inoxydable.

Assortiment of yellow waterproof crowns, **short pipe** ; stainless steel.

Sortiment von gelbe wasserdichte Kronen, **kurzes Rohr** ; Edelstahl.

Surtido de coronas herméticas amarillas, **cañón corto** ; acero inoxidable.

Assortimento di corone impermeabili gialle, **canotto corto** ; acciaio inossidabile.

Sortido de coroas estanques amarelas, **canhão curto** ; aço inoxidável.

**Contenu - Contents - Inhalt - Contenido - Contenuto - Conteúdo :
 5 modèles - models - Modelle - modelos - modelli - modelos
 4x MSA84.223-090 /.224-090 /.225-090 /.226-090 /.227-090**

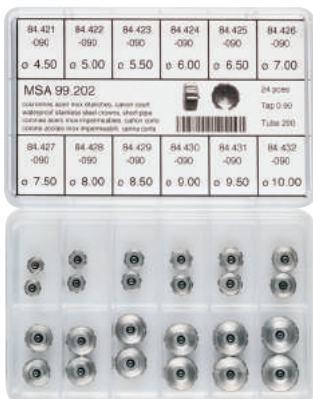

MSA	Qt.	Kg
99.202	24x	0.025

Ø T 2.00 mm

Assortiment de couronnes étanches couleur acier, **canon court** ; acier inoxydable.

Assortiment of steel colour waterproof crowns, **short pipe** ; stainless steel.

Sortiment von Stahlfarbe wasserdichte Kronen, **kurzes Rohr** ; Edelstahl.

Surtido de coronas herméticas color acero, **cañón corto** ; acero inoxidable.

Assortimento di corone impermeabili colore acciaio, **canotto corto** ; acciaio inossidabile.

Sortido de coroas estanques cor aço, **canhão curto** ; aço inoxidável.

**Contenu - Contents - Inhalt - Contenido - Contenuto - Conteúdo :
 12 modèles - models - Modelle - modelos - modelli - modelos
 2x MSA84.421-090 /.422-090 /.423-090 /.424-090 /.425-090
 /.426-090 /.427-090 /.428-090 /.429-090 /.430-090 /.431-090
 /.432-090**

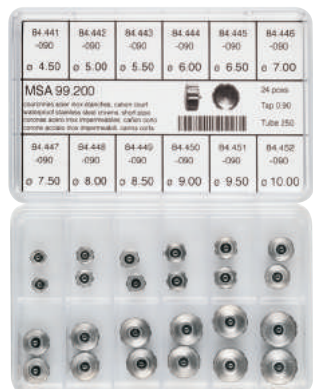

MSA	Qt.	Kg
99.200	24x	0.025

Ø T 2.50 mm

Assortiment de couronnes étanches couleur acier, **canon court** ; acier inoxydable.

Assortiment of steel colour waterproof crowns, **short pipe** ; stainless steel.

Sortiment von Stahlfarbe wasserdichte Kronen, **kurzes Rohr** ; Edelstahl.

Surtido de coronas herméticas color acero, **cañón corto** ; acero inoxidable.

Assortimento di corone impermeabili colore acciaio, **canotto corto** ; acciaio inossidabile.

Sortido de coroas estanques cor aço, **canhão curto** ; aço inoxidável.

**Contenu - Contents - Inhalt - Contenido - Contenuto - Conteúdo :
 12 modèles - models - Modelle - modelos - modelli - modelos
 2x MSA84.441-090 /.442-090 /.443-090 /.444-090 /.445-090
 /.446-090 /.447-090 /.448-090 /.449-090 /.450-090 /.451-090
 /.452-090**



MSA	Qt.	Kg
99.261	20x	0.051

Ø T 3.00 - 3.50 mm

Assortiment de couronnes étanches couleur acier, **canon court** ; acier inoxydable.

Assortiment of steel colour waterproof crowns, **short pipe** ; stainless steel.

Sortiment von Stahlfarbe wasserdichte Kronen, **kurzes Rohr** ; Edelstahl.

Surtido de coronas herméticas color acero, **cañón corto** ; acero inoxidable.

Assortimento di corone impermeabili colore acciaio, **cannotto corto** ; acciaio inossidabile.

Sortido de coroas estanques cor aço, **canhão curto** ; aço inoxidável.

**Contenu - Contents - Inhalt - Contenido - Contenuto - Conteúdo :
 10 modèles - models - Modelle - modelos - modelli - modelos
 2x MSA84.453-090 /.455-090 /.457-090 /.459-090 /.461-090
 /.475-090 /.477-090 /.479-090 /.481-090 /.483-090**

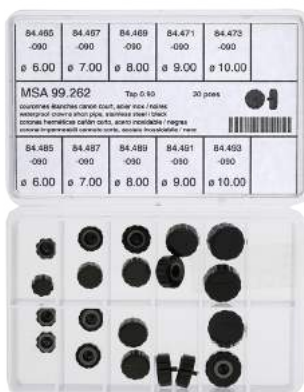

MSA	Qt.	Kg
99.262	20x	0.051

Ø T 3.00 - 3.50 mm

Assortiment de couronnes étanches noires, **canon court** ; acier inoxydable.

Assortiment of black waterproof crowns, **short pipe** ; stainless steel.

Sortiment von schwarzen wasserdichte Kronen, **kurzes Rohr** ; Edelstahl.

Surtido de coronas herméticas negras, **cañón corto** ; acero inoxidable.

Assortimento di corone impermeabili nere, **cannotto corto** ; acciaio inossidabile.

Sortido de coroas estanques pretas, **canhão curto** ; aço inoxidável.

**Contenu - Contents - Inhalt - Contenido - Contenuto - Conteúdo :
 10 modèles - models - Modelle - modelos - modelli - modelos
 2x MSA84.465-090 /.467-090 /.469-090 /.471-090 /.473-090
 /.485-090 /.487-090 /.489-090 /.491-090 /.493-090**



MSA	Qt.	Kg
99.265	16x	0.044

Ø T 3.00 - 3.50 mm

Assortiment de couronnes étanches couleur acier, **canon court** ; acier inoxydable.

Assortiment of steel colour waterproof crowns, **short pipe** ; stainless steel.

Sortiment von Stahlfarbe wasserdichte Kronen, **kurzes Rohr** ; Edelstahl.

Surtido de coronas herméticas color acero, **cañón corto** ; acero inoxidable.

Assortimento di corone impermeabili colore acciaio, **cannotto corto** ; acciaio inossidabile.

Sortido de coroas estanques cor aço, **canhão curto** ; aço inoxidável.

**Contenu - Contents - Inhalt - Contenido - Contenuto - Conteúdo :
 8 modèles - models - Modelle - modelos - modelli - modelos
 2x MSA84.454-090 /.456-090 /.458-090 /.460-090 /.476-090
 /.478-090 /.480-090 /.482-090**



MSA	Qt.	Kg
99.266	16x	0.044

Ø T 3.00 - 3.50 mm

Assortiment de couronnes étanches noires, **canon court** ; acier inoxydable.

Assortiment of black waterproof crowns, **short pipe** ; stainless steel.

Sortiment von schwarzen wasserdichte Kronen, **kurzes Rohr** ; Edelstahl.

Surtido de coronas herméticas negras, **cañón corto** ; acero inoxidable.

Assortimento di corone impermeabili nere, **cannotto corto** ; acciaio inossidabile.

Sortido de coroas estanques pretas, **canhão curto** ; aço inoxidável.

**Contenu - Contents - Inhalt - Contenido - Contenuto - Conteúdo :
 8 modèles - models - Modelle - modelos - modelli - modelos
 2x MSA84.466-090 /.468-090 /.470-090 /.472-090 /.486-090
 /.488-090 /.490-090 /.492-090**



MSA	Qt.	Kg
99.269	144x	0.488

Ø T 3.00 - 3.50 mm

Assortiment de couronnes étanches couleur acier, **canons courts et longs** ; acier inoxydable.

Assortiment of steel colour waterproof crowns, **short and long pipes** ; stainless steel.

Sortiment von Stahlfarbe wasserdichte Kronen, **kurzen und langen Rohre** ; Edelstahl.

Surtido de coronas herméticas color acero, **cañones cortos y largos** ; acciaio inossidabile.

Assortimento di corone impermeabili colore acciaio, **cannotti corti e lunghi** ; acciaio inossidabile.

Sortido de coroas estanques cor aço, **canhões curtos e longos** ; aço inoxidável.

**Contenu - Contents - Inhalt - Contenido - Contenuto - Conteúdo :
 36 modèles - models - Modelle - modelos - modelli - modelos
 4x MSA84.453-090 /.454-090 /.455-090 /.456-090 /.457-090
 /.458-090 /.459-090 /.460-090 /.461-090 /.475-090 /.476-090
 /.477-090 /.478-090 /.479-090 /.480-090 /.481-090 /.482-090
 /.483-090 /.660-090 /.661-090 /.662-090 /.663-090 /.664-090
 /.665-090 /.666-090 /.667-090 /.668-090 /.680-090 /.681-090
 /.682-090 /.683-090 /.684-090 /.685-090 /.686-090 /.687-090
 /.688-090**



MSA	Qt.	Kg
99.270	144x	0.488

Ø T 3.00 - 3.50 mm

Assortiment de couronnes étanches noires, **canons courts et longs** ; acier inoxydable.

Assortiment of black waterproof crowns, **short and long pipes** ; stainless steel.

Sortiment von schwarzen wasserdichte Kronen, **kurzen und langen Rohre** ; Edelstahl.

Surtido de coronas herméticas negras, **cañones cortos y largos** ; acciaio inossidabile.

Assortimento di corone impermeabili nere, **cannotti corti e lunghi** ; acciaio inossidabile.





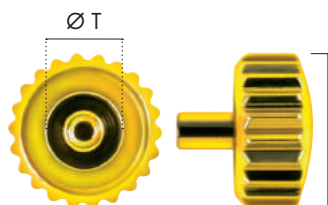











































Sortido de coroas estanques pretas, **canhões curtos e longos** ; aço inoxidável.











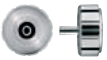



















**Contenu - Contents - Inhalt - Contenido - Contenuto - Conteúdo :
 36 modèles - models - Modelle - modelos - modelli - modelos
 4x MSA84.465-090 /.466-090 /.467-090 /.468-090 /.469-090
 /.470-090 /.471-090 /.472-090 /.473-090 /.485-090 /.486-090
 /.487-090 /.488-090 /.489-090 /.490-090 /.491-090 /.492-090
 /.493-090 /.670-090 /.671-090 /.672-090 /.673-090 /.674-090
 /.675-090 /.676-090 /.677-090 /.678-090 /.690-090 /.691-090
 /.692-090 /.693-090 /.694-090 /.695-090 /.696-090 /.697-090
 /.698-090**















Couronne étanche couleur acier et jaune, **canon long** ; acier inoxydable.
 Steel colour and yellow waterproof crown, **long pipe** ; stainless steel.
 Stahlfarbe und gelbe wasserdichte Krone, **langes Rohr** ; Edelstahl.
 Corona hermética color acero y amarilla, **cañón largo** ; acero inoxidable.
 Corona impermeabile colore acciaio e gialla, **cannotto lungo** ; acciaio inossidabile.
 Coroa estanque cor aço e amarela, **canhão longo** ; aço inoxidável.

MSA	Couleur acier/Steel colour	Ø mm	Ø T mm	Ø Tar./Top. mm	MSA	Jaune/Noir Yellow/Black
84.352-070		3.00	1.60	0.70	84.252-070	
84.352-080*		3.00	1.60	0.80	84.252-080	
84.352-090		3.00	1.60	0.90	84.252-090	
84.601-090		3.00	1.60	0.90	84.701-090	
84.362-070		3.00	1.80	0.70	84.262-070	
84.362-080*		3.00	1.80	0.80	84.262-080	
84.362-090		3.00	1.80	0.90	84.262-090	
84.611-090		3.00	1.80	0.90	84.711-090	
84.618-090		3.00	2.00	0.90	84.720-090	
84.353-070		3.50	1.60	0.70	84.253-070	
84.353-080*		3.50	1.60	0.80	84.253-080	
84.353-090		3.50	1.60	0.90	84.253-090	
84.602-090		3.50	1.60	0.90	84.702-090	
84.363-070		3.50	1.80	0.70	84.263-070*	
84.363-080*		3.50	1.80	0.80	84.263-080*	
84.363-090		3.50	1.80	0.90	84.263-090	
84.612-090		3.50	1.80	0.90	84.712-090	
84.373-070		3.50	2.00	0.70	84.273-070	
84.373-080		3.50	2.00	0.80	84.273-080	
84.373-090		3.50	2.00	0.90	84.273-090	
84.619-090		3.50	2.00	0.90	84.721-090	
84.374-070*		3.80	2.00	0.70	84.274-070*	
84.374-080*		3.80	2.00	0.80	84.274-080	
84.374-090		3.80	2.00	0.90	84.274-090	
84.603-090		4.00	1.60	0.90	84.703-090	
84.613-090		4.00	1.80	0.90	84.713-090	
84.375-070*		4.00	2.00	0.70	84.275-070*	
-		4.00	2.00	0.80	84.275-080*	
84.375-090		4.00	2.00	0.90	84.275-090	
84.620-090		4.00	2.00	0.90	84.722-090	

MSA	Couleur acier/Steel colour	Ø mm	Ø T mm	Ø Tar./Tap. mm	MSA	Jaune/Noir Yellow/Black
84.385-070*		4.00	2.50	0.70	84.285-070*	
84.385-080*		4.00	2.50	0.80	-	
84.385-090		4.00	2.50	0.90	84.285-090	
84.604-090		4.50	1.60	0.90	84.704-090	
84.614-090		4.50	1.80	0.90	84.714-090	
84.376-090		4.50	2.00	0.90	84.276-090	
84.621-090		4.50	2.00	0.90	84.723-090	
84.386-090		4.50	2.50	0.90	84.286-090	
84.641-090		4.50	2.50	0.90	-	-
84.605-090		5.00	1.60	0.90	84.705-090	
84.615-090		5.00	1.80	0.90	84.715-090	
84.377-090		5.00	2.00	0.90	84.277-090	
84.622-090		5.00	2.00	0.90	84.724-090	
84.387-090		5.00	2.50	0.90	84.287-090	
84.642-090		5.00	2.50	0.90	-	-
84.606-090		5.50	1.60	0.90	84.706-090	
84.616-090		5.50	1.80	0.90	84.716-090	
84.623-090		5.50	2.00	0.90	84.725-090	
84.389-090		5.50	2.50	0.90	84.289-090	
84.643-090		5.50	2.50	0.90	-	-
84.624-090		6.00	2.00	0.90	-	-
84.644-090		6.00	2.50	0.90	-	-
84.660-090		6.00	3.00	0.90	84.670-090	
84.680-090		6.00	3.50	0.90	84.690-090	
84.625-090		6.50	2.00	0.90	-	-
84.645-090		6.50	2.50	0.90	-	-
84.661-090		6.50	3.00	0.90	84.671-090	
84.681-090		6.50	3.50	0.90	84.691-090	

MSA	Couleur acier/Steel colour	Ø mm	Ø T mm	Ø Tar./Tap. mm	MSA	Jaune/Noir Yellow/Black
84.626-090		7.00	2.00	0.90	-	-
84.646-090		7.00	2.50	0.90	-	-
84.662-090		7.00	3.00	0.90	84.672-090	
84.682-090		7.00	3.50	0.90	84.692-090	
84.627-090		7.50	2.00	0.90	-	-
84.647-090		7.50	2.50	0.90	-	-
84.663-090		7.50	3.00	0.90	84.673-090	
84.683-090		7.50	3.50	0.90	84.693-090	
84.628-090		8.00	2.00	0.90	-	-
84.648-090		8.00	2.50	0.90	-	-
84.664-090		8.00	3.00	0.90	84.674-090	
84.684-090		8.00	3.50	0.90	84.694-090	
84.629-090		8.50	2.00	0.90	-	-
84.649-090		8.50	2.50	0.90	-	-
84.665-090		8.50	3.00	0.90	84.675-090	
84.685-090		8.50	3.50	0.90	84.695-090	
84.630-090		9.00	2.00	0.90	-	-
84.650-090		9.00	2.50	0.90	-	-
84.666-090		9.00	3.00	0.90	84.676-090	
84.686-090		9.00	3.50	0.90	84.696-090	

MSA	Couleur acier/Steel colour	Ø mm	Ø T mm	Ø Tar./Tap. mm	MSA	Jaune/Noir Yellow/Black
84.631-090		9.50	2.00	0.90	-	-
84.651-090		9.50	2.50	0.90	-	-
84.667-090		9.50	3.00	0.90	84.677-090	
84.687-090		9.50	3.50	0.90	84.697-090	
84.632-090		10.00	2.00	0.90	-	-
84.652-090		10.00	2.50	0.90	-	-
84.668-090		10.00	3.00	0.90	84.678-090	
84.688-090		10.00	3.50	0.90	84.698-090	

Kg 0.001 * Jusqu'à épuisement des stocks / Will be discontinued after end of stock / Solange Vorrat /
 Hasta agotamiento del stock / Fino ad esaurimento dello stock / Até esgotamento do stock

1/1

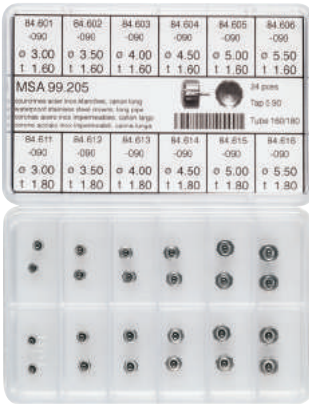

MSA	Qt.	Kg
99.205	24x	0.031

Ø T 1.60 - 1.80 mm

Assortiment de couronnes étanches couleur acier, **canon long** ; acier inoxydable.
 Assortiment of steel colour waterproof crowns, **long pipe** ; stainless steel.
 Sortiment von Stahlfarbe wasserdichte Kronen, **langes Rohr** ; Edelstahl.
 Sortido de coronas herméticas color acero, **cañón largo** ; acciaio inossidabile.
 Assortimento di corone impermeabili colore acciaio, **cannotto lungo** ; acciaio inossidabile.
 Sortido de coroas estanques cor aço, **canhão longo** ; aço inoxidável.

Contenu - Contents - Inhalt - Contenido - Contenuto - Conteúdo :
12 modèles - models - Modelle - modelos - modelli - modelos
2x MSA84.601-090 /.602-090 /.603-090 /.604-090 /.605-090
/.606-090 /.611-090 /.612-090 /.613-090 /.614-090 /.615-090
/.616-090

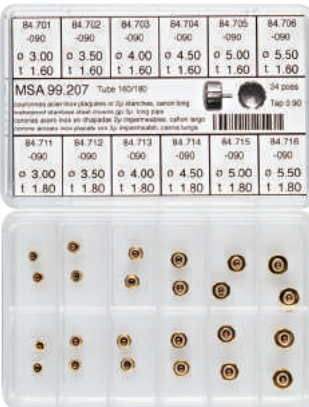

MSA	Qt.	Kg
99.207	24x	0.031

Ø T 1.60 - 1.80 mm

Assortiment de couronnes étanches jaunes, **canon long** ; acier inoxydable.
 Assortiment of yellow waterproof crowns, **long pipe** ; stainless steel.
 Sortiment von gelbe wasserdichte Kronen, **langes Rohr** , Edelstahl.
 Sortido de coronas herméticas amarillas, **cañón largo** ; acero inoxidable.
 Assortimento di corone impermeabili gialle, **cannotto lungo** ; acciaio inossidabile.
 Sortido de coroas estanques amarelas, **canhão longo** ; aço inoxidável.

Contenu - Contents - Inhalt - Contenido - Contenuto - Conteúdo :
12 modèles - models - Modelle - modelos - modelli - modelos
2x MSA84.701-090 /.702-090 /.703-090 /.704-090 /.705-090
/.706-090 /.711-090 /.712-090 /.713-090 /.714-090 /.715-090
/.716-090

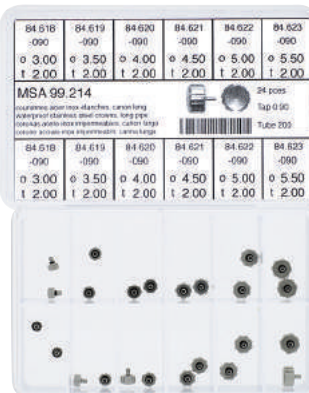

MSA	Qt.	Kg
99.214	24x	0.030

Ø T 2.00 mm

Assortiment de couronnes étanches couleur acier, **canon long** ; acier inoxydable.
 Assortiment of steel colour waterproof crowns, **long pipe** ; stainless steel.
 Sortiment von Stahlfarbe wasserdichte Kronen, **langes Rohr** ; Edelstahl.
 Sortido de coronas herméticas color acero, **cañón largo** ; acciaio inossidabile.
 Assortimento di corone impermeabili colore acciaio, **cannotto lungo** ; acciaio inossidabile.
 Sortido de coroas estanques cor aço, **canhão longo** ; aço inoxidável.

Contenu - Contents - Inhalt - Contenido - Contenuto - Conteúdo :
6 modèles - models - Modelle - modelos - modelli - modelos
4x MSA84.618-090 /.619-090 /.620-090 /.621-090 /.622-090
/.623-090



MSA	Qt.	Kg
99.215	24x	0.030

Ø T 2.00 mm

Assortiment de couronnes étanches jaunes, **canon long** ; acier inoxydable.

Assortiment of yellow waterproof crowns, **long pipe** ; stainless steel.

Sortiment von gelbe wasserdichte Kronen, **langes Rohr** , Edelstahl.

Surtido de coronas herméticas amarillas, **cañón largo** ; acero inoxidable.

Assortimento di corone impermeabili gialle, **cannotto lungo** ; acciaio inossidabile.

Sortido de coroas estanques amarelas, **canhão longo** ; aço inoxidável.

**Contenu - Contents - Inhalt - Contenido - Contenuto - Conteúdo :
 6 modèles - models - Modelle - modelos - modelli - modelos
 4x MSA84.720-090 /.721-090 /.722-090 /.723-090 /.724-090
 /.725-090**

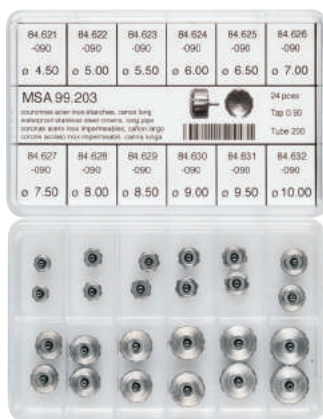

MSA	Qt.	Kg
99.203	24x	0.025

Ø T 2.00 mm

Assortiment de couronnes étanches couleur acier, **canon long** ; acier inoxydable.

Assortiment of steel colour waterproof crowns, **long pipe** ; stainless steel.

Sortiment von Stahlfarbe wasserdichte Kronen, **langes Rohr** ; Edelstahl.

Surtido de coronas herméticas color acero, **cañón largo** ; acciaio inossidabile.

Assortimento di corone impermeabili colore acciaio, **cannotto lungo** ; acciaio inossidabile.

Sortido de coroas estanques cor aço, **canhão longo** ; aço inoxidável.

**Contenu - Contents - Inhalt - Contenido - Contenuto - Conteúdo :
 12 modèles - models - Modelle - modelos - modelli - modelos
 2x MSA84.621-090 /.622-090 /.623-090 /.624-090 /.625-090
 /.626-090 /.627-090 /.628-090 /.629-090 /.630-090 /.631-090
 /.632-090**

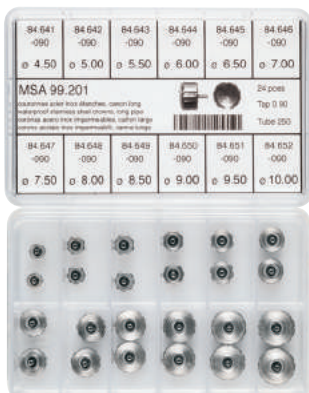

MSA	Qt.	Kg
99.201	24x	0.025

Ø T 2.50 mm

Assortiment de couronnes étanches couleur acier, **canon long** ; acier inoxydable.

Assortiment of steel colour waterproof crowns, **long pipe** ; stainless steel.

Sortiment von Stahlfarbe wasserdichte Kronen, **langes Rohr** ; Edelstahl.

Surtido de coronas herméticas color acero, **cañón largo** ; acciaio inossidabile.

Assortimento di corone impermeabili colore acciaio, **cannotto lungo** ; acciaio inossidabile.

Sortido de coroas estanques cor aço, **canhão longo** ; aço inoxidável.

**Contenu - Contents - Inhalt - Contenido - Contenuto - Conteúdo :
 12 modèles - models - Modelle - modelos - modelli - modelos
 2x MSA84.641-090 /.642-090 /.643-090 /.644-090 /.645-090
 /.646-090 /.647-090 /.648-090 /.649-090 /.650-090 /.651-090
 /.652-090**



MSA	Qt.	Kg
99.263	20x	0.051

Ø T 3.00 - 3.50 mm

Assortiment de couronnes étanches couleur acier, **canon court** ; acier inoxydable.

Assortiment of steel colour waterproof crowns, **short pipe** ; stainless steel.

Sortiment von Stahlfarbe wasserdichte Kronen, **kurzes Rohr** ; Edelstahl.

Surtido de coronas herméticas color acero, **cañón corto** ; acero inoxidable.

Assortimento di corone impermeabili colore acciaio, **canotto corto** ; acciaio inossidabile.

Sortido de coroas estanques cor aço, **canhão curto** ; aço inoxidável.

**Contenu - Contents - Inhalt - Contenido - Contenuto - Conteúdo :
 10 modèles - models - Modelle - modelos - modelli - modelos
 2x MSA84.660-090 /.662-090 /.664-090 /.666-090 /.668-090
 /.680-090 /.682-090 /.684-090 /.686-090 /.688-090**



MSA	Qt.	Kg
99.264	20x	0.052

Ø T 3.00 - 3.50 mm

Assortiment de couronnes étanches noires, **canon court** ; acier inoxydable.

Assortiment of black waterproof crowns, **short pipe** ; stainless steel.

Sortiment von schwarzen wasserdichte Kronen, **kurzes Rohr** ; Edelstahl.

Surtido de coronas herméticas negras, **cañón corto** ; acero inoxidable.

Assortimento di corone impermeabili nere, **canotto corto** ; acciaio inossidabile.

Sortido de coroas estanques pretas, **canhão curto** ; aço inoxidável.

**Contenu - Contents - Inhalt - Contenido - Contenuto - Conteúdo :
 10 modèles - models - Modelle - modelos - modelli - modelos
 2x MSA84.670-090 /.672-090 /.674-090 /.676-090 /.678-090
 /.690-090 /.692-090 /.694-090 /.696-090 /.698-090**



MSA	Qt.	Kg
99.267	16x	0.044

Ø T 3.00 - 3.50 mm

Assortiment de couronnes étanches couleur acier, **canon court** ; acier inoxydable.

Assortiment of steel colour waterproof crowns, **short pipe** ; stainless steel.

Sortiment von Stahlfarbe wasserdichte Kronen, **kurzes Rohr** ; Edelstahl.

Surtido de coronas herméticas color acero, **cañón corto** ; acero inoxidable.

Assortimento di corone impermeabili colore acciaio, **canotto corto** ; acciaio inossidabile.

Sortido de coroas estanques cor aço, **canhão curto** ; aço inoxidável.

**Contenu - Contents - Inhalt - Contenido - Contenuto - Conteúdo :
 8 modèles - models - Modelle - modelos - modelli - modelos
 2x MSA84.661-090 /.663-090 /.665-090 /.667-090 /.681-090
 /.683-090 /.685-090 /.687-090**



MSA	Qt.	Kg
99.268	16x	0.044

Ø T 3.00 - 3.50 mm

Assortiment de couronnes étanches noires, **canon court** ; acier inoxydable.

Assortiment of black waterproof crowns, **short pipe** ; stainless steel.

Sortiment von schwarzen wasserdichte Kronen, **kurzes Rohr** ; Edelstahl.

Surtido de coronas herméticas negras, **cañón corto** ; acero inoxidable.

Assortimento di corone impermeabili nere, **cannotto corto** ; acciaio inossidabile.

Sortido de coroas estanques pretas, **canhão curto** ; aço inoxidável.

**Contenu - Contents - Inhalt - Contenido - Contenuto - Conteúdo :
 8 modèles - models - Modelle - modelos - modelli - modelos
 2x MSA84.671-090 /.673-090 /.675-090 /.677-090 /.691-090
 /.693-090 /.695-090 /.697-090**



MSA	Qt.	Kg
99.269	144x	0.488

Ø T 3.00 - 3.50 mm

Assortiment de couronnes étanches couleur acier, **canons courts et longs** ; acier inoxydable.

Assortiment of steel colour waterproof crowns, **short and long pipes** ; stainless steel.

Sortiment von Stahlfarbe wasserdichte Kronen, **kurzen und langen Rohre** ; Edelstahl.

Surtido de coronas herméticas color acero, **cañones cortos y largos** ; acciaio inossidabile.

Assortimento di corone impermeabili colore acciaio, **cannotti corti e lunghi** ; acciaio inossidabile.

Sortido de coroas estanques cor aço, **canhões curtos e longos** ; aço inoxidável.

**Contenu - Contents - Inhalt - Contenido - Contenuto - Conteúdo :
 36 modèles - models - Modelle - modelos - modelli - modelos
 4x MSA84.453-090 /.454-090 /.455-090 /.456-090 /.457-090
 /.458-090 /.459-090 /.460-090 /.461-090 /.475-090 /.476-090
 /.477-090 /.478-090 /.479-090 /.480-090 /.481-090 /.482-090
 /.483-090 /.660-090 /.661-090 /.662-090 /.663-090 /.664-090
 /.665-090 /.666-090 /.667-090 /.668-090 /.680-090 /.681-090
 /.682-090 /.683-090 /.684-090 /.685-090 /.686-090 /.687-090
 /.688-090**



MSA	Qt.	Kg
99.270	144x	0.488

Ø T 3.00 - 3.50 mm

Assortiment de couronnes étanches noires, **canons courts et longs** ; acier inoxydable.

Assortiment of black waterproof crowns, **short and long pipes** ; stainless steel.

Sortiment von schwarzen wasserdichte Kronen, **kurzen und langen Rohre** ; Edelstahl.

Surtido de coronas herméticas negras, **cañones cortos y largos** ; acciaio inossidabile.







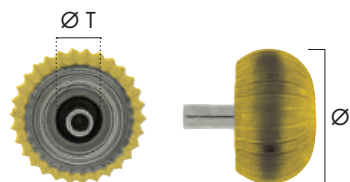



































Assortimento di corone impermeabili nere, **cannotti corti e lunghi** ; acciaio inossidabile.

Sortido de coroas estanques pretas, **canhões curtos e longos** ; aço inoxidável.

**Contenu - Contents - Inhalt - Contenido - Contenuto - Conteúdo :
 36 modèles - models - Modelle - modelos - modelli - modelos
 4x MSA84.465-090 /.466-090 /.467-090 /.468-090 /.469-090
 /.470-090 /.471-090 /.472-090 /.473-090 /.485-090 /.486-090
 /.487-090 /.488-090 /.489-090 /.490-090 /.491-090 /.492-090
 /.493-090 /.670-090 /.671-090 /.672-090 /.673-090 /.674-090
 /.675-090 /.676-090 /.677-090 /.678-090 /.690-090 /.691-090
 /.692-090 /.693-090 /.694-090 /.695-090 /.696-090 /.697-090
 /.698-090**



Couronne étanche type Pumpkin couleur acier et jaune ; acier inoxydable.
 Steel colour and yellow waterproof crown Pumpkin type ; stainless steel.
 Stahlfarbe und gelbe wasserdichte Krone Pumpkin Typ ; Edelstahl.
 Corona hermética tipo Pumpkin color acero y amarilla ; acero inoxidable.
 Corona impermeabile tipo Pumpkin colore acciaio e gialla ; acciaio inossidabile.
 Coroa estanque tipo Pumpkin cor aço e amarela ; aço inoxidável.

MSA	Couleur acier / Steel colour	Ø mm	Hauteur tête / Head height mm	Ø T mm	Longueur canon / Pipe length mm	Ø Tar. / Tap. mm	MSA	Jaune / Yellow
84.810-090	 	3.50	2.20	1.80	2.00	0.90	84.910-090	 
84.811-090	 	3.50	2.20	2.00	2.00	0.90	84.911-090	 
84.812-090	 	4.00	2.50	1.80	2.00	0.90	84.912-090	 
84.813-090	 	4.00	2.50	2.00	2.00	0.90	84.913-090	 
84.814-090	 	4.00	2.50	2.50	2.00	0.90	84.914-090	 
84.815-090	 	4.50	2.60	1.80	2.00	0.90	84.915-090	 
84.816-090	 	4.50	2.60	2.00	2.00	0.90	84.916-090	 
84.817-090	 	4.50	2.60	2.50	2.00	0.90	84.917-090	 
84.818-090	 	5.00	3.00	1.80	2.50	0.90	84.918-090	 
84.819-090	 	5.00	3.00	2.00	2.50	0.90	84.919-090	 
84.820-090	 	5.00	3.00	2.50	2.50	0.90	84.920-090	 
84.821-090	 	5.50	3.00	1.80	2.50	0.90	84.921-090	 
84.822-090	 	5.50	3.00	2.00	2.50	0.90	84.922-090	 
84.823-090	 	5.50	3.00	2.50	2.50	0.90	84.923-090	 
84.824-090	 	6.00	3.30	2.00	3.00	0.90	-	-
84.825-090	 	6.00	3.30	2.50	3.00	0.90	-	-
84.826-090	 	6.50	3.50	2.00	3.00	0.90	-	-
84.827-090	 	6.50	3.50	2.50	3.00	0.90	-	-
84.828-090	 	7.00	4.00	2.00	3.00	0.90	-	-
84.829-090	 	7.00	4.00	2.50	3.00	0.90	-	-
84.830-090	 	7.50	4.50	2.00	3.00	0.90	-	-
84.831-090	 	7.50	4.50	2.50	3.00	0.90	-	-
84.832-090	 	8.00	4.50	2.00	3.00	0.90	-	-
84.833-090	 	8.00	4.50	2.50	3.00	0.90	-	-

Kg 0.001

1/1

84.810	84.811	84.812	84.813	84.815	84.816
ø 3,50	ø 3,50	ø 4,00	ø 4,00	ø 4,50	ø 4,50
h 2,20	h 2,20	h 2,50	h 2,50	h 2,60	h 2,60
øT 1,80	øT 2,00	øT 1,80	øT 2,00	øT 1,80	øT 2,00

MSA 99.257 MSA 99.257

COURONNES ÉTANCHES TYPE PUMPKIN COULEUR ACIER ; acier inoxydable
 WASSERDICHT KRONEN PUMPKIN TYP. STEEL COLOR
 CORONAS HERMÉTICAS TIPO PUMPKIN COLORES ACERO ; acero inoxidable
 CORONE IMPERMEABILI TIPO PUMPKIN COLORE ACCIAIO ; acciaio inossidabile



Assortiment de couronnes étanches type Pumpkin couleur acier ; acier inoxydable.
 Assortment of steel colour waterproof crowns Pumpkin type ; stainless steel.
 Sortiment von Stahlfarbe wasserdichte Kronen Pumpkin Typ ; Edelstahl.
 Surtido de coronas herméticas tipo Pumpkin color acero ; acero inoxidable.
 Assortimento di corone impermeabili tipo Pumpkin colore acciaio ; acciaio inossidabile.
 Sortido de coroas estanques tipo Pumpkin cor aço ; aço inoxidável.

**Contenu - Contents - Inhalt - Contenido - Contenuto - Conteúdo :
 12 modèles - models - Modelle - modelos - modelli - modelos
 2x MSA84.810-090 /.811-090 /.812-090 /.813/090 /.815-090
 /.816-090 /.818-090 /.819-090 /.821.090 /.822-090 /.824-090
 /.826-090**

MSA	Qt.	Kg
99.257	24x	0.031

84.910	84.911	84.912	84.913	84.915	84.916
ø 3,50	ø 3,50	ø 4,00	ø 4,00	ø 4,50	ø 4,50
h 2,20	h 2,20	h 2,50	h 2,50	h 2,60	h 2,60
øT 1,80	øT 2,00	øT 1,80	øT 2,00	øT 1,80	øT 2,00

MSA 99.258 MSA 99.258

COURONNES ÉTANCHES TYPE PUMPKIN JAUNES ; acier inoxydable
 WASSERDICHT KRONEN PUMPKIN TYP. YELLOW
 CORONAS HERMÉTICAS TIPO PUMPKIN AMARILLAS ; acero inoxidable
 CORONE IMPERMEABILI TIPO PUMPKIN GIALLE ; acciaio inossidabile



Assortiment de couronnes étanches type Pumpkin jaunes ; acier inoxydable.
 Assortment of yellow waterproof crowns Pumpkin type ; stainless steel.
 Sortiment von gelbe wasserdichte Kronen Pumpkin Typ ; Edelstahl.
 Surtido de coronas herméticas tipo Pumpkin amarillas ; acero inoxidable.
 Assortimento di corone impermeabili tipo Pumpkin gialle ; acciaio inossidabile.
 Sortido de coroas estanques tipo Pumpkin amarelas ; aço inoxidável.

**Contenu - Contents - Inhalt - Contenido - Contenuto - Conteúdo :
 12 modèles - models - Modelle - modelos - modelli - modelos
 2x MSA84.910-090 /.911-090 /.912-090 /.913/090 /.915-090
 /.916-090 /.918-090 /.919-090 /.920.090 /.921-090 /.922-090
 /.923-090**

MSA	Qt.	Kg
99.258	24x	0.031

84.814	84.817	84.820	84.823	84.825	84.827
ø 4,00	ø 4,50	ø 5,00	ø 5,50	ø 6,00	ø 6,50
h 2,50	h 2,60	h 3,00	h 3,00	h 3,30	h 3,50
øT 2,50	øT 2,50	øT 2,50	øT 2,50	øT 2,50	øT 2,50

MSA 99.259 MSA 99.259

COURONNES ÉTANCHES TYPE PUMPKIN COULEUR ACIER ; acier inoxydable
 WASSERDICHT KRONEN PUMPKIN TYP. STEEL COLOR
 CORONAS HERMÉTICAS TIPO PUMPKIN COLORES ACERO ; acero inoxidable
 CORONE IMPERMEABILI TIPO PUMPKIN COLORE ACCIAIO ; acciaio inossidabile



Assortiment de couronnes étanches type Pumpkin couleur acier ; acier inoxydable.
 Assortment of steel colour waterproof crowns Pumpkin type ; stainless steel.
 Sortiment von Stahlfarbe wasserdichte Kronen Pumpkin Typ ; Edelstahl.
 Surtido de coronas herméticas tipo Pumpkin color acero ; acero inoxidable.
 Assortimento di corone impermeabili tipo Pumpkin colore acciaio ; acciaio inossidabile.
 Sortido de coroas estanques tipo Pumpkin cor aço ; aço inoxidável.

**Contenu - Contents - Inhalt - Contenido - Contenuto - Conteúdo :
 12 modèles - models - Modelle - modelos - modelli - modelos
 2x MSA84.814-090 /.817-090 /.820-090 /.823/090 /.825-090
 /.827-090 /.828-090 /.829-090 /.830.090 /.831-090 /.832-090
 /.833-090**

MSA	Qt.	Kg
99.259	24x	0.031



Couronne étanche avec canon coupé à ras et double joint couleur acier et jaune ; acier inoxydable.

Steel colour and yellow waterproof crown with short cut pipe and double gasket ; stainless steel.

Stahlfarbe und gelbe wasserdichte Krone mit kurzes geschnitten Rohr und Doppel Dichtung ; Edelstahl.

Corona hermética con cañón cortado raso y doble junta color acero y amarilla ; acero inoxidable.

Corona impermeabile con canotto tagliato raso e doppia guarnizione colore acciaio e gialla ; acciaio inossidabile.

Coroa estanque com canhão cortado raso e dupla junta cor aço e amarela ; aço inoxidável.

MSA	Couleur acier/Steel colour	Ø mm	Ø T mm	Ø Tar./Tap. mm	MSA	Jaune/Yellow
84.800-090*		4.00	2.50	0.90	84.900-090*	
84.801-090*		4.50	2.50	0.90	84.901-090*	
84.802-090*		5.00	2.50	0.90	84.902-090*	
-	-	5.50	2.50	0.90	84.903-090*	
84.804-090*		6.00	2.50	0.90	84.904-090*	
-	-	6.50	2.50	0.90	84.905-090*	
-	-	7.00	2.50	0.90	84.906-090*	
84.807-090*		7.50	2.50	0.90	84.907-090*	
84.808-090*		8.00	2.50	0.90	84.908-090*	
84.809-090*		8.50	2.50	0.90	84.909-090*	

Kg 0.001 * Jusqu'à épuisement des stocks / Will be discontinued after end of stock / Solange Vorrat / Hasta agotamiento del stock / Fino ad esaurimento dello stock / Até esgotamento do stock

1/1

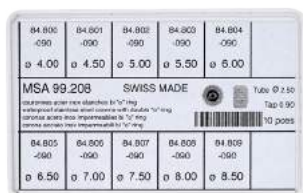

MSA	Qt.	Kg
99.208*	10x	0.031

Assortiment de couronnes étanches avec canon coupé à ras et double joint couleur acier ; acier inoxydable.

Assortiment of steel colour waterproof crown with short cut pipe and double gasket ; stainless steel.

Sortiment von Stahlfarbe wasserdichte Kronen mit kurzes geschnitten Rohr und Doppel Dichtung ; Edelstahl.

Surtido de coronas herméticas con cañón cortado raso y doble junta color acero ; acero inoxidable.

Assortimento di corone impermeabili con canotto tagliato raso e doppia guarnizione colore acciaio ; acciaio inossidabile.

Sortido de coroas estanques com canhão cortado raso e dupla junta cor aço ; aço inoxidável.

**Contenu - Contents - Inhalt - Contenido - Contenuto - Conteúdo :
 10 modèles - models - Modelle - modelos - modelli - modelos
 1x MSA84.800-090 / .801-090 / .802-090 / .803/090 / .804-090
 / .805-090 / .806-090 / .807-090 / .808.090 / .809-090**

* Jusqu'à épuisement des stocks / Will be discontinued after end of stock / Solange Vorrat /
 Hasta agotamiento del stock / Fino ad esaurimento dello stock / Até esgotamento do stock

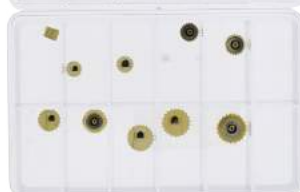
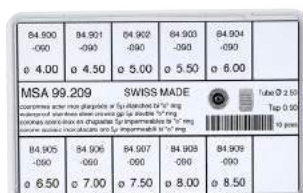

MSA	Qt.	Kg
99.209*	10x	0.031

Assortiment de couronnes étanches avec canon coupé à ras et double joint jaunes ; acier inoxydable.

Assortiment of yellow waterproof crown with short cut pipe and double gasket ; stainless steel.

Sortiment von gelbe wasserdichte Kronen mit kurzes geschnitten Rohr und Doppel Dichtung ; Edelstahl.

Surtido de coronas herméticas con cañón cortado raso y doble junta amarillas ; acero inoxidable.

Assortimento di corone impermeabili con canotto tagliato raso e doppia guarnizione gialle ; acciaio inossidabile.

Sortido de coroas estanques com canhão cortado raso e dupla junta amarelas ; aço inoxidável.





















**Contenu - Contents - Inhalt - Contenido - Contenuto - Conteúdo :
 10 modèles - models - Modelle - modelos - modelli - modelos
 1x MSA84.900-090 / .901-090 / .902-090 / .903/090 / .904-090
 / .905-090 / .906-090 / .907-090 / .908.090 / .909-090**

* Jusqu'à épuisement des stocks / Will be discontinued after end of stock / Solange Vorrat /
 Hasta agotamiento del stock / Fino ad esaurimento dello stock / Até esgotamento do stock



Couronne étanche demi-boule couleur acier et jaune ; acier inoxydable.
 Steel colour and yellow waterproof domed crown ; stainless steel.
 Stahlfarbe und gelbe wasserdichte Halbkugel Krone ; Edelstahl.
 Corona hermética media bola color acero y amarilla ; acero inoxidable.
 Corona impermeabile demiboule colore acciaio e gialla ; acciaio inossidabile.
 Coroa estanque meia bola cor aço e amarela ; aço inoxidável.

MSA	Couleur acier/Steel colour	Ø mm	Ø T mm	Ø Tar./Tap. mm	Dôme/Dome	MSA	Jaune/Yellow
80.501-070		2.80	1.60	0.70	-	80.001-070	
80.501-080		2.80	1.60	0.80	-	80.001-080	
80.501		2.80	1.60	0.90	-	80.001	
80.502-070		3.00	1.60	0.70	Bas/Low	80.002-070	
80.502-080		3.00	1.60	0.80	Bas/Low	80.002-080	
80.502		3.00	1.60	0.90	Bas/Low	80.002	
80.503-070		3.00	1.60	0.70	Haut/High	80.003-070	
80.503-080		3.00	1.60	0.80	Haut/High	80.003-080	
80.503		3.00	1.60	0.90	Haut/High	80.003	
80.507-070		3.00	1.80	0.70	-	80.007-070	
80.507-080		3.00	1.80	0.80	-	80.007-080	
80.507		3.00	1.80	0.90	-	80.007	
80.513-070		3.25	2.00	0.70	-	80.013-070	
80.513-080		3.25	2.00	0.80	-	80.013-080	
80.513		3.25	2.00	0.90	-	80.013	
80.504-070		3.50	1.60	0.70	Bas/Low	80.004-070	
80.504-080		3.50	1.60	0.80	Bas/Low	80.004-080	
80.504		3.50	1.60	0.90	Bas/Low	80.004	
80.505-070		3.50	1.60	0.70	Haut/High	80.005-070	
80.505-080		3.50	1.60	0.80	Haut/High	80.005-080	
80.505		3.50	1.60	0.90	Haut/High	80.005	
80.508-070		3.50	1.80	0.70	-	80.008-070	
80.508-080		3.50	1.80	0.80	-	80.008-080	
80.508		3.50	1.80	0.90	-	80.008	
80.510-070		3.50	2.00	0.70	Bas/Low	80.010-070	
80.510-080		3.50	2.00	0.80	Bas/Low	80.010-080	
80.510		3.50	2.00	0.90	Bas/Low	80.010	
80.511-070		3.50	2.00	0.70	Haut/High	80.011-070	
80.511-080		3.50	2.00	0.80	Haut/High	80.011-080	
80.511		3.50	2.00	0.90	Haut/High	80.011	
80.512-070		3.75	2.00	0.70	-	80.012-070	
80.512-080		3.75	2.00	0.80	-	80.012-080	
80.512		3.75	2.00	0.90	-	80.012	
80.506-070		4.00	1.60	0.70	-	80.006-070	
80.506-080		4.00	1.60	0.80	-	80.006-080	
80.506		4.00	1.60	0.90	-	80.006	

MSA	Couleur acier/Steel colour	Ø mm	Ø T mm	Ø Tar./Tap. mm	Dôme/Dome	MSA	Jaune/Yellow
80.509-070		4.00	1.80	0.70	-	80.009-070	
80.509-080		4.00	1.80	0.80	-	80.009-080	
80.509		4.00	1.80	0.90	-	80.009	
80.514-070		4.00	2.00	0.70	-	80.014-070	
80.514-080		4.00	2.00	0.80	-	80.014-080	
80.514		4.00	2.00	0.90	-	80.014	
80.515-070		4.50	2.00	0.70	-	80.015-070	
80.515-080		4.50	2.00	0.80	-	80.015-080	
80.515		4.50	2.00	0.90	-	80.015	
80.517-070		4.50	2.50	0.70	-	80.017-070	
80.517-080		4.50	2.50	0.80	-	80.017-080	
80.517		4.50	2.50	0.90	-	80.017	
80.516-070		5.00	2.00	0.70	-	80.016-070	
80.516-080		5.00	2.00	0.80	-	80.016-080	
80.516		5.00	2.00	0.90	-	80.016	
80.518-070		5.00	2.50	0.70	-	80.018-070	
80.518-080		5.00	2.50	0.80	-	80.018-080	
80.518		5.00	2.50	0.90	-	80.018	
80.519		5.50	2.00	0.90	-	80.019	
80.520		5.50	2.50	0.90	-	80.020	
80.521		6.00	2.00	0.90	-	80.021	
80.522		6.00	2.50	0.90	-	80.022	

Kg 0.001

1/1



**Ø taraudage/tap/Gewinde/rosca/maschiatura/rosca 0.70 mm
 Ø T 2.00 - 2.50 mm**

Assortiment de couronnes étanches demi-boule couleur acier et jaunes ; acier inoxydable.
 Assortiment of steel colour and yellow waterproof domed crowns ; stainless steel.
 Sortiment von Stahlfarbe und gelbe wasserdichte Halbkugel Kronen ; Edelstahl.
 Surtido de coronas herméticas media bola color acero y amarillas ; acero inoxidable.
 Assortimento di corone impermeabili demiboule colore acciaio e gialle ; acciaio inossidabile.
 Sortido de coroas estanques meia bola cor aço e amarelas ; aço inoxidável.

**Contenu - Contents - Inhalt - Contenido - Contenuto - Conteúdo :
 12 modèles - models - Modelle - modelos - modelli - modelos
 2x MSA80.013-070 /.014-070 /.015-070 /.016-070 /.017-070
 /.018-070 /.513-070 /.514-070 /.515-070 /.516-070 /.517-070
 /.518-070**

MSA	Qt.	Kg
99.072	24x	0.049

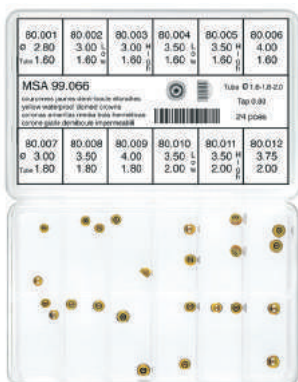

**Ø taraudage/tap/Gewinde/rosca/maschiatura/rosca 0.80 mm
 Ø T 1.60 - 1.80 - 2.00 mm**

Assortiment de couronnes étanches demi-boule jaunes ; acier inoxydable.
 Assortiment of yellow waterproof domed crowns ; stainless steel.
 Sortiment von gelbe wasserdichte Halbkugel Kronen ; Edelstahl.
 Surtido de coronas herméticas media bola amarillas ; acero inoxidable.
 Assortimento di corone impermeabili demiboule gialle ; acciaio inossidabile.
 Sortido de coroas estanques meia bola amarelas ; aço inoxidável.

**Contenu - Contents - Inhalt - Contenido - Contenuto - Conteúdo :
 12 modèles - models - Modelle - modelos - modelli - modelos
 2x MSA80.001-080 /.002-080 /.003-080 /.004-080 /.005-080
 /.006-080 /.007-080 /.008-080 /.009-080 /.010-080 /.011-080
 /.012-080**

MSA	Qt.	Kg
99.066	24x	0.049

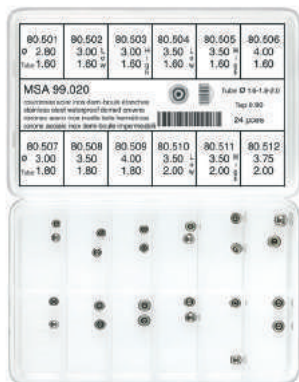

**Ø taraudage/tap/Gewinde/rosca/maschiatura/rosca 0.90 mm
 Ø T 1.60 - 1.80 - 2.00 mm**

Assortiment de couronnes étanches demi-boule couleur acier ; acier inoxydable.
 Assortment of steel colour waterproof domed crowns ; stainless steel.
 Sortiment von Stahlfarbe wasserdichte Halbkugel Kronen ; Edelstahl.
 Surtido de coronas herméticas media bola color acero ; acero inoxidable.
 Assortimento di corone impermeabili demiboule colore acciaio ; acciaio inossidabile.
 Sortido de coroas estanques meia bola cor aço ; aço inoxidável.

**Contenu - Contents - Inhalt - Contenido - Contenuto - Conteúdo :
 12 modèles - models - Modelle - modelos - modelli - modelos
 2x MSA80.501 /.502 /.503 /.504 /.505 /.506 /.507 /.508 /.509
 /.510 /.511 /.512**

MSA	Qt.	Kg
99.020	24x	0.049



**Ø taraudage/tap/Gewinde/rosca/maschiatura/rosca 0.90 mm
 Ø T 1.60 - 1.80 - 2.00 mm**

Assortiment de couronnes étanches demi-boule jaunes ; acier inoxydable.
 Assortment of yellow waterproof domed crowns ; stainless steel.
 Sortiment von gelbe wasserdichte Halbkugel Kronen ; Edelstahl.
 Surtido de coronas herméticas media bola amarillas ; acero inoxidable.
 Assortimento di corone impermeabili demiboule gialle ; acciaio inossidabile.
 Sortido de coroas estanques meia bola amarelas ; aço inoxidável.

**Contenu - Contents - Inhalt - Contenido - Contenuto - Conteúdo :
 12 modèles - models - Modelle - modelos - modelli - modelos
 2x MSA80.001 /.002 /.003 /.004 /.005 /.006 /.007 /.008 /.009
 /.010 /.011 /.012**

MSA	Qt.	Kg
99.019	24x	0.049

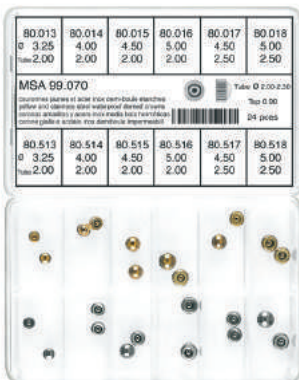

**Ø taraudage/tap/Gewinde/rosca/maschiatura/rosca 0.90 mm
 Ø T 2.00 - 2.50 mm**

Assortiment de couronnes étanches demi-boule couleur acier et jaunes ; acier inoxydable.
 Assortment of steel colour and yellow waterproof domed crowns ; stainless steel.
 Sortiment von Stahlfarbe und gelbe wasserdichte Halbkugel Kronen ; Edelstahl.
 Surtido de coronas herméticas media bola color acero y amarillas ; acero inoxidable.
 Assortimento di corone impermeabili demiboule colore acciaio e gialle ; acciaio inossidabile.
 Sortido de coroas estanques meia bola cor aço e amarelas ; aço inoxidável.

**Contenu - Contents - Inhalt - Contenido - Contenuto - Conteúdo :
 12 modèles - models - Modelle - modelos - modelli - modelos
 2x MSA80.013 /.014 /.015 /.016 /.017 /.018 /.513 /.514 /.515
 /.516 /.517 /.518**

MSA	Qt.	Kg
99.070	24x	0.049

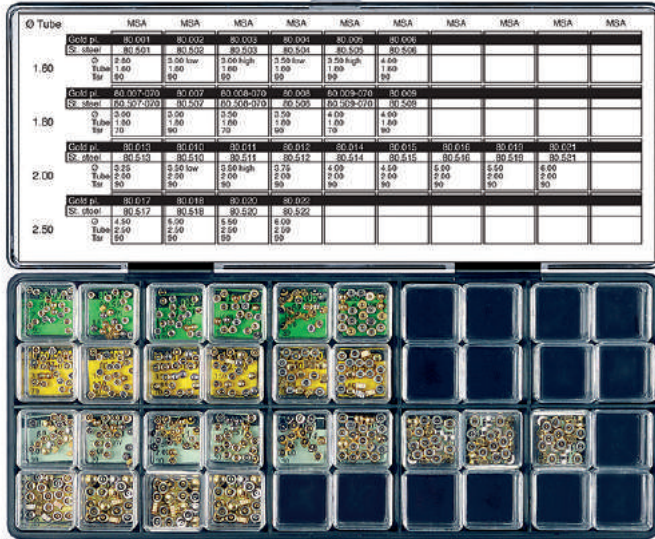

MSA	Qt.	Kg
99.254	500x	0.750

Ø taraudage/tap/Gewinde/rosca/maschiatura/rosca 0.70 - 0.90 mm
Ø T 1.60 - 1.80 - 2.00 - 2.50 mm

Assortiment de couronnes étanches demi-boule, 125 couleur acier et 375 jaunes ; acier inoxydable.

Assortiment of waterproof domed crowns, 125 steel colour and 375 yellow ; stainless steel.

Sortiment von wasserdichte Halbkugel Kronen, 125 Stahlfarbe und 375 gelbe ; Edelstahl.

Surtido de coronas herméticas media bola, 125 color acero y 375 amarillas ; acero inoxidable.

Assortimento di corone impermeabili demiboule, 125 colore acciaio e 375 gialle ; acciaio inossidabile.

Sortido de coroas estanques meia bola, 125 cor aço e 375 amarelas ; aço inoxidável.

Contenu - Contents - Inhalt - Contenido - Conteúdo :

50 modèles - models - Modelle - modelos - modelli - modelos

15x MSA80.001 / .002 / .003 / .004 / .005 / .006 / .007 / .007-070 / .008 / .008-070 / .009 / .009-070

/ .010 / .011 / .012 / .013 / .014 / .015 / .016 / .017 / .018 / .019 / .020 / .021 / .022

5x MSA80.501 / .502 / .503 / .504 / .505 / .506 / .507 / .507-070 / .508 / .508-070 / .509 / .509-070

/ .510 / .511 / .512 / .513 / .514 / .515 / .516 / .517 / .518 / .519 / .520 / .521 / .522

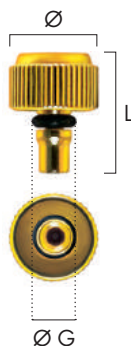

Couronne japonaise couleur acier et jaune ; acier inoxydable.
 Steel colour and yellow Japanese crown ; stainless steel.
 Stahlfarbe und gelbe Japanische Krone ; Edelstahl.
 Corona japonesa color acero y amarilla ; acero inoxidable.
 Corona giapponese colore acciaio e gialla ; acciaio inossidabile.
 Coroa japonesa cor aço e amarela ; aço inoxidável.

MSA	Couleur acier / Steel colour	N°/No.	Ø mm	Ø G mm	Ø Tar./Tap. mm	Longueur / Length mm	MSA	Jaune / Yellow	N°/No.
-	-	-	3.00	1.50	0.70	2.20	81.002		506-D502B
-	-	-	3.50	1.50	0.90	4.10	81.001		506-B782B
81.504		506-2251 506-225XU	3.50	1.80	0.70	2.10	81.004		506-2254
-	-	-	3.50	1.80	0.90	4.70	81.008*		506-4494
-	-	-	3.75	1.80	0.90	5.10	81.009		506-3814
81.507		506-2101 506-2100-A	4.00	1.80	0.90	2.50	81.007		506-2104
81.506		506-2881 506-2880-A	4.00	1.80	0.90	2.70	81.006		506-2884

Kg 0.001 * Jusqu'à épuisement des stocks / Will be discontinued after end of stock / Solange Vorrat /
 Hasta agotamiento del stock / Fino ad esaurimento dello stock / Até esgotamento do stock 1/1



MSA	Qt.	Kg
99.111	20x	0.074

Assortiment de couronnes japonaises couleur acier et jaunes ; acier inoxydable.
 Assortiment of steel colour and yellow Japanese crowns ; stainless steel.
 Sortiment von Stahlfarbe und gelbe Japanische Kronen ; Edelstahl.
 Surtido de coronas japonesas color acero y amarillas ; acero inoxidable.
 Assortimento di corone giapponesi colore acciaio e gialle ; acciaio inossidabile.
 Sortido de coroas japonesas cor aço e amarelas ; aço inoxidável.

Contenu - Contents - Inhalt - Contenido - Contenuto - Conteúdo :
10 modèles - models - Modelle - modelos - modelli - modelos
2x MSA81.001 / .002 / .004 / .006 / .007 / .008 / .009 / .504 / .506 / .507

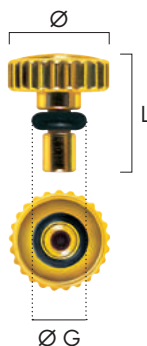

Couronne japonaise couleur acier et jaune ; acier inoxydable.
 Steel colour and yellow Japanese crown ; stainless steel.
 Stahlfarbe und gelbe Japanische Krone ; Edelstahl.
 Corona japonesa color acero y amarilla ; acero inoxidable.
 Corona giapponese colore acciaio e gialla ; acciaio inossidabile.
 Coroa japonesa cor aço e amarela ; aço inoxidável.

MSA	Couleur acier/ Steel colour	N°/No.	Ø mm	Ø G mm	Ø Tar./Tap. mm	Longueur/ Length mm	MSA	Jaune/ Yellow	N°/No.
-	-	-	3.00	1.30	0.60	3.75	81.108		38-0211NGP
-	-	-	3.00	1.30	0.60	3.95	81.112		38-0105NGP
-	-	-	3.00	1.30	0.60	4.15	81.107		38-0209NGP
81.614		38-0239S	3.00	1.40	0.80	3.95	81.114		38-0239NGP
-	-	-	3.00	1.50	0.60	2.55	81.109		38-0216NGP
-	-	-	3.50	1.30	0.60	4.15	81.111		38-0225NGP
-	-	-	3.50	1.40	0.80	3.60	81.103		38-0147NGP
-	-	-	3.50	1.40	0.80	3.95	81.105		38-0153NGP
-	-	-	3.50	1.40	0.80	4.15	81.104		38-0149NGP
-	-	-	3.50	1.50	0.60	2.55	81.110		38-0224NGP
81.615		38-0223S	3.50	1.50	0.90	3.60	81.115		38-0223NGP
81.613*		38-0157S	3.50	1.70	0.80	2.40	81.113		38-0157NGP
81.606*		38-0154S	4.00	1.50	0.80	4.00	81.106		38-0154NGP
81.602		38-0075S	4.00	2.10	0.90	4.85	81.102		38-0075NGP
81.601		38-0064S	4.50	1.80	0.90	2.50	81.101		38-0064NGP

Kg 0.001 * Jusqu'à épuisement des stocks / Will be discontinued after end of stock / Solange Vorrat /
 Hasta agotamiento del stock / Fino ad esaurimento dello stock / Até esgotamento do stock

1/1

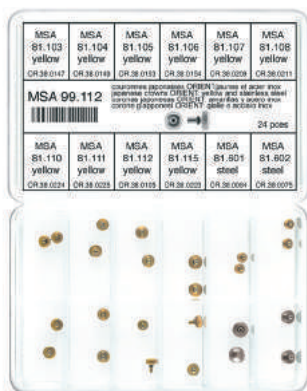

Assortiment de couronnes japonaises couleur acier et jaunes ; acier inoxydable.

Assortment of steel colour and yellow Japanese crowns ; stainless steel.

Sortiment von Stahlfarbe und gelbe Japanische Kronen ; Edelstahl.

Surtido de coronas japonesas color acero y amarillas ; acero inoxidable.

Assortimento di corone giapponesi colore acciaio e gialle ; acciaio inossidabile.

Sortido de coroas japonesas cor aço e amarelas ; aço inoxidável.





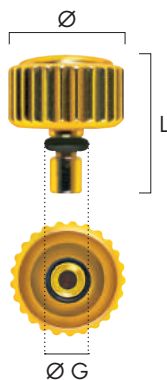





































Contenu - Contents - Inhalt - Contenido - Contenuto - Conteúdo :
12 modèles - models - Modelle - modelos - modelli - modelos
2x MSA81.103 /.104 /.105 /.106 /.107 /.108 /.110 /.111 /.112
/.115 /.601 /.602

































MSA	Qt.	Kg
99.112	24x	0.049



Couronne japonaise couleur acier et jaune ; acier inoxydable.
 Steel colour and yellow Japanese crown ; stainless steel.
 Stahlfarbe und gelbe Japanische Krone ; Edelstahl.
 Corona japonesa color acero y amarilla ; acero inoxidable.
 Corona giapponese colore acciaio e gialla ; acciaio inossidabile.
 Coroa japonesa cor aço e amarela ; aço inoxidável.

MSA	Couleur acier / Steel colour	N°/No.	Ø mm	Ø G mm	Ø Tar./Tap. mm	Longueur/ Length mm	MSA	Jaune/ Yellow	N°/No.
-	-	-	2.50	1.00	0.60	3.35	81.201		25M04NA1
-	-	-	3.00	1.00	0.60	3.00	81.206		30M82NA1
81.707		30M68NS1	3.00	1.00	0.60	3.10	81.207		30M68NF1
81.708		30M98NS1	3.00	1.00	0.60	3.25	81.208		30M98NA1
-	-	-	3.00	1.00	0.60	3.45	81.246		30MA2NA1
-	-	-	3.00	1.00	0.60	3.65	81.265		6M30A3NNG1
-	-	-	3.00	1.10	0.80	4.25	81.275*		30M89NN1
81.704		30M08NS1	3.00	1.30	0.80	3.55	81.204		30M08NA1
-	-	-	3.00	1.30	0.80	3.60	81.245		30MA6NA1
-	-	-	3.00	1.30	0.80	4.00	81.258		8M30A0NNG2
-	-	-	3.00	1.50	0.60	2.20	81.244		30NA9NN1
81.702*		30E02NS1	3.00	1.50	0.80	2.55	81.202*		30E02NF1
81.705		30M22NS1	3.00	1.50	0.80	3.90	81.205		30M22NA1
-	-	-	3.20	1.00	0.60	3.15	81.241		32M63NN1
81.709		32M29NS1	3.20	1.00	0.60	3.25	81.209		32M29NN1
81.710		32N23NS1	3.20	1.40	0.60	2.10	81.210		32N23NN1
-	-	-	3.20	1.40	0.80	3.75	81.243		32M01NN1
81.712		35D15NS1	3.50	-	0.80	2.00	81.212		35D15NN1
81.711		35D03NS1	3.50	-	0.90	2.00	81.211		35D03NN1
-	-	-	3.50	1.00	0.60	3.00	81.262		35MK6NA1
-	-	-	3.50	1.00	0.60	3.05	81.248*		35MX7NN1
81.742		8M35A9SNW0	3.50	1.00	0.80	3.75	-	-	-

MSA	Couleur acier/ Steel colour	N°/No.	Ø mm	Ø G mm	Ø Tar./Tap. mm	Longueur/ Length mm	MSA	Jaune/ Yellow	N°/No.
81.719		35M94NS1	3.50	1.30	0.80	3.00	81.219		35M94NA1
81.721		35M98NS1	3.50	1.30	0.80	3.30	81.221		35M98NA1
-	-	-	3.50	1.30	0.80	3.35	81.224		35MR6NF1
-	-	-	3.50	1.30	0.80	3.70	81.264		8M35A7NNG0
-	-	-	3.50	1.30	0.80	3.75	81.252		8M35A9NNG0
81.725		35MR8NS1	3.50	1.30	0.80	3.85	81.225		35MR8NF1
81.750		8M35A0SNW1	3.50	1.30	0.80	4.00	81.250		8M35A0NNG1
-	-	-	3.50	1.30	0.80	4.00	81.251		8M35A0NNG2
-	-	-	3.50	1.30	0.80	4.00	81.259		8M35A0BNG1
-	-	-	3.50	1.30	0.80	4.00	81.260		8M35B4NNG1
-	-	-	3.50	1.30	0.80	4.10	81.228		35MV3NN1
-	-	-	3.50	1.30	0.80	4.25	81.271*		35MK3NN1
-	-	-	3.50	1.30	0.80	4.85	81.254*		35MX2NF1
-	-	-	3.50	1.40	0.80	2.25	81.247*		35E43NN1
-	-	-	3.50	1.40	0.80	4.00	81.216		35M81NN1
-	-	-	3.50	1.40	0.80	4.00	81.220*		35M97NN1
81.717		35M82NS1	3.50	1.40	0.80	4.10	81.217		35M82NA1
81.727		35MU6NC1	3.50	1.40	0.80	4.35	81.227		35MU6NF1
81.726		35MS4NC1	3.50	1.40	0.80	4.90	81.226		35MS4NF1
81.713		35E09NS1	3.50	-	0.80	2.45	81.213		35E09NN1
81.772*		35MRONC1	3.50	1.50	0.80	4.85	-	-	-
81.722		35ME9NS1	3.50	1.70	0.80	2.75	81.222		35ME9NN1
-	-	-	3.50	1.70	0.80	3.25	81.223		35MJ3NN1
-	-	-	3.50	1.80	0.60	4.75	81.214		35M18NA1
81.715		35M68NS1	3.50	1.80	0.90	4.70	81.215		35M68NA1
81.718		35M90NS1	3.50	1.80	0.90	4.85	81.218		35M90NA1
81.744		40MK5NS1	4.00	1.00	0.90	4.80	-	-	-
-	-	-	4.00	1.30	0.80	4.80	81.253		8M40A0NNG1
81.761		8M40A0SNW1	4.00	1.30	0.80	4.80	-	-	-
-	-	-	4.00	1.30	0.80	4.80	81.263		8M40A0NNG3
81.766		9M40B3SNW0	4.00	1.30	0.80	5.00	81.266		9M40B3SNG0

MSA	Couleur acier/ Steel colour	N°/No.	Ø mm	Ø G mm	Ø Tar./Tap. mm	Longueur/ Length mm	MSA	Jaune/ Yellow	N°/No.
-	-	-	4.00	1.50	0.80	3.80	81.256*		40M92NA1
-	-	-	4.00	1.50	0.80	3.95	81.257*		40MJ3NA1
-	-	-	4.00	1.50	0.80	4.40	81.236		40MH1NN1
81.731		40MD4NS1	4.00	1.50	0.80	4.75	81.231		40MD4NA1
-	-	-	4.00	1.50	0.80	4.80	81.255*		40M78NA1/NF1
-	-	-	4.00	1.50	0.80	5.10	81.249		40M82NA1
-	-	-	4.00	1.80	0.80	4.20	81.278		40M97NA1
81.735		40MC5NS1	4.00	1.80	0.90	4.45	81.235		40MC5NN1
-	-	-	4.00	1.80	0.90	4.55	81.239		40ML9NN1
81.734		40M76NS1	4.00	1.80	0.90	4.70	81.234		40M76NA1
81.737		40MK1NS1	4.00	1.80	0.90	5.00	81.237		40MK1NN1
-	-	-	4.00	2.00	0.90	4.00	81.238		40ML5NN1
81.729		40M54NS1	4.00	2.00	1.00	4.80	81.229		40M54NA1
81.730		40M58NS1	4.00	2.00	1.00	5.00	81.230		40M58NA1
-	-	-	4.00	2.20	0.90	5.00	81.233		40M71NA1
-	-	-	4.00	2.20	0.90	5.25	81.232		40M69NN1
81.738		40ML5NS1	4.00	2.20	0.90	4.05	-	-	-
81.774		9M40B5SNW0	4.00	2.40	0.80	4.30	-	-	-
81.743		9M45F3SNS0	4.50	1.10	0.90	4.60	-	-	-
81.777		45M47NS1	4.50	1.30	0.80	5.25	-	-	-
81.773		45E41NS1	4.50	1.50	0.80	4.95	-	-	-
-	-	-	4.50	1.80	0.80	5.30	81.276		45M47NN1
81.745		45M60NS1	4.50	1.85	0.80	5.75	-	-	-
81.740		45M30NS1	4.50	2.00	1.00	5.80	81.240		45M30NA1
81.741		8K45C1TNW0	4.50	2.15	0.80	6.20	-	-	-

Kg 0.001 * Jusqu'à épuisement des stocks / Will be discontinued after end of stock / Solange Vorrat /
 Hasta agotamiento del stock / Fino ad esaurimento dello stock / Até esgotamento do stock

1/1



Assortiment de couronnes japonaises couleur acier ; acier inoxydable.
Assortment of steel colour Japanese crowns ; stainless steel.
 Sortiment von Stahlfarbe Japanische Kronen ; Edelstahl.
Surtido de coronas japonesas color acero ; acero inoxidable.
 Assortimento di corone giapponesi colore acciaio ; acciaio inossidabile.
Sortido de coroas japonesas cor aço ; aço inoxidável.

MSA	Qt.	Kg
99.114	24x	0.049

Contenu - Contents - Inhalt - Contenido - Contenuto - Conteúdo :
12 modèles - models - Modelle - modelos - modelli - modelos
2x MSA81.705 /.709 /.717 /.719 /.721 /.722 /.725 /.730 /.734
/.735 /.737 /.761

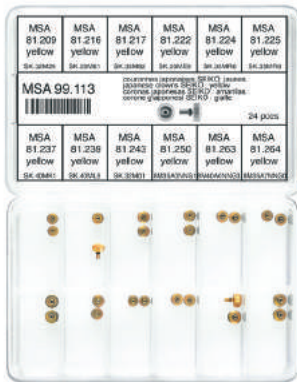

Assortiment de couronnes japonaises jaunes ; acier inoxydable.
Assortment of yellow Japanese crowns ; stainless steel.
 Sortiment von gelbe Japanische Kronen ; Edelstahl.
Surtido de coronas japonesas amarillas ; acero inoxidable.
 Assortimento di corone giapponesi gialle ; acciaio inossidabile.
Sortido de coroas japonesas amarelas ; aço inoxidável.

MSA	Qt.	Kg
99.113	24x	0.049

Contenu - Contents - Inhalt - Contenido - Contenuto - Conteúdo :
12 modèles - models - Modelle - modelos - modelli - modelos
2x MSA81.209 /.216 /.217 /.222 /.224 /.225 /.237 /.239 /.243
/.250 /.263 /.264



MSA	Qt.	Kg
99.260	80x	0.340

Assortiment de couronnes japonaises couleur acier et jaunes ; acier inoxydable.

Assortiment of steel colour and yellow Japanese crowns ; stainless steel.

Sortiment von Stahlfarbe und gelbe Japanische Kronen ; Edelstahl.

Sortido de coronas japonesas color acero y amarillas ; acero inoxidable.

Assortimento di corone giapponesi colore acciaio e gialle ; acciaio inossidabile.

Sortido de coroaas japonesas cor aço e amarelas ; aço inoxidável.

Contenu - Contents - Inhalt - Contenido - Conteúdo :

40 modèles - models - Modelle - modelos - modelli - modelos

2x MSA81.001 / .101 / .108 / .201 / .208 / .209 / .216 / .217 / .222 / .224 / .225 / .229 / .237 / .239 / .243 / .250 / .263 / .264 / .602 / .615 / .705 / .709 / .717 / .721 / .722 / .725 / .729 / .730 / .731 / .737 / .739 / .740 / .741 / .742 / .743 / .744 / .745 / .761 / .773

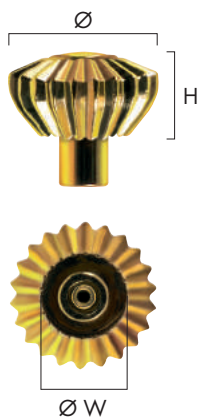

Couronne pour montres de poche couleur acier et jaune ; acier inoxydable.
 Steel colour and yellow pocket watches crown ; stainless steel.

Stahlfarbe und gelbe Krone für Taschenuhren ; Edelstahl.

Corona para relojes de bolsillo color acero y amarilla ; acero inoxidable.

Corona per orologi da tasca colore acciaio e gialla ; acciaio inossidabile.

Coroa para relógios de bolso cor aço e amarela ; aço inoxidável.

MSA	Couleur acier / Steel colour	Ø mm	Ø W mm	Ø Tar./ Tap. mm	H mm	MSA	Jaune/Yellow
63.550*		3.80	2.20	0.90	1.85	63.050*	
63.501*		4.00	2.30	0.90	2.00	63.001	
63.551*		4.00	2.80	0.90	2.80	63.051*	
63.552*		4.50	2.80	0.90	2.50	63.052	
63.553*		4.50	3.00	0.90	2.90	63.053	
63.554*		5.00	2.80	0.90	3.00	63.054	
63.502		5.00	3.00	0.90	2.70	63.002	
63.555		6.00	3.05	0.90	2.90	63.055	
63.555-100*		6.00	3.05	1.00	2.90	-	-
63.503		6.00	3.30	0.90	3.20	63.003	
63.503-140*		6.00	3.30	1.40	3.20	-	-
63.504		6.50	3.50	0.90	3.60	63.004	
63.504-120*		6.50	3.50	1.20	3.60	-	-
63.557		7.00	3.05	0.90	4.00	63.057	
63.557-120		7.00	3.05	1.20	4.00	-	-
63.505		7.25	4.00	0.90	3.90	63.005	
63.505-120		7.25	4.00	1.20	3.90	63.005-120	
63.505-140		7.25	4.00	1.40	3.90	-	-

MSA	Couleur acier/ Steel colour	Ø mm	Ø W mm	Ø Tar./ Tap. mm	H mm	MSA	Jaune/Yellow
63.558-090		8.00	4.20	0.90	4.50	63.058*	
63.558-110*		8.00	4.20	1.10	4.50	-	-
63.558-120		8.00	4.20	1.20	4.50	-	-
63.558-140		8.00	4.20	1.40	4.50	-	-
63.506		8.25	4.20	0.90	4.50	63.006	
63.506-120		8.25	4.20	1.20	4.50	63.006-120	
63.506-140		8.25	4.20	1.40	4.50	-	-
63.559-090		9.00	4.60	0.90	4.60	63.059	
63.559-140		9.00	4.60	1.40	4.60	-	-

Kg 0.001 * Jusqu'à épuisement des stocks / Will be discontinued after end of stock / Solange Vorrat /
 Hasta agotamiento del stock / Fino ad esaurimento dello stock / Até esgotamento do stock

1/1



MSA	Qt.	Kg
99.255	36x	0.030

Assortiment de couronnes pour montres de poche couleur acier et jaunes ; acier inoxydable.

Assortiment of steel colour and yellow pocket watches crowns ; stainless steel.

Sortiment von Stahlfarbe und gelbe Kronen für Taschenuhren ; Edelstahl.

Surtido de coronas para relojes de bolsillo color acero y amarillas ; acero inoxidable.

Assortimento di corone per orologi da tasca colore acciaio e gialle ; acciaio inossidabile.

Sortido de coroas para relógios de bolso cor aço e amarelas ; aço inoxidável.

Contenu - Contents - Inhalt - Contenido - Contenuto - Conteúdo :
18 modèles - models - Modelle - modelos - modelli - modelos
2x MSA63.002 / .003 / .004 / .005 / .005-120 / .006 / .006-120
/ .054 / .059 / .503 / .504 / .505 / .505-120 / .506 / .506-120 / .506-
140 / .557 / .559-140



Couronne pour montres de poche avec poussoir couleur acier et jaune ; acier inoxydable.

Steel colour and yellow pocket watches crown with pusher ; stainless steel.

Stahlfarbe und gelbe Krone für Taschenuhren mit Drucker ; Edelstahl.

Corona para relojes de bolsillo con pulsador color acero y amarilla ; acero inoxidable.

Corona per orologi da tasca con pulsante colore acciaio e gialla ; acciaio inossidabile.

Coroa para relógios de bolso com botão cor aço e amarela ; aço inoxidável.

MSA	Couleur acier/ Steel colour	Ø mm	Ø W mm	Ø Tar./ Tap. mm	H mm	MSA	Jaune/Yellow
63.650		4.00	2.80	0.90	2.35	63.150	
63.600		4.00	2.80	0.90	2.40	63.100	
63.700		4.00	2.80	0.90	2.50	63.200	
63.701		4.50	2.80	0.90	2.80	63.201	
63.601		4.50	3.20	0.90	2.70	63.101	
63.702*		5.00	2.80	0.90	2.95	63.202	
63.651		5.00	3.05	0.90	2.70	63.151	
63.652		5.00	3.10	0.90	2.40	63.152	
63.602		5.00	4.00	0.90	3.00	63.102	
63.703		6.00	4.20	0.90	3.40	63.203	
63.704		6.10	3.00	0.90	3.20	63.204	
63.653		6.50	4.00	0.90	3.20	63.153	
63.705		7.00	4.25	0.90	4.00	63.205	
63.654		7.25	4.10	0.90	3.90	63.154	
63.654-120		7.25	4.10	1.20	3.90	-	-
63.706		8.00	5.00	0.90	4.50	63.206	
63.655		8.25	4.25	0.90	4.35	63.155	
63.655-120		8.25	4.25	1.20	4.35	63.155-120	

Kg 0.001 * Jusqu'à épuisement des stocks / Will be discontinued after end of stock / Solange Vorrat /
 Hasta agotamiento del stock / Fino ad esaurimento dello stock / Até esgotamento do stock

1/1



Assortiment de couronnes pour montres de poche avec poussoir couleur acier et jaunes ; acier inoxydable.

Assortment of steel colour and yellow pocket watches crowns with pusher ; stainless steel.

Sortiment von Stahlfarbe und gelbe Kronen für Taschenuhren mit Drucker ; Edelstahl.

Surtido de coronas para relojes de bolsillo con pulsador color acero y amarillas ; acero inoxidable.

Assortimento di corone per orologi da tasca con pulsante colore acciaio e gialle ; acciaio inossidabile.

Sortido de coroas para relógios de bolso com botão cor aço e amarelas ; aço inoxidável.

Contenu - Contents - Inhalt - Contenido - Contenuto - Conteúdo :
18 modèles - models - Modelle - modelos - modelli - modelos
2x MSA63.100 /.101 /.102 /.151 /.152 /.153 /.154 /.155 /.204
/.600 /.602 /.652 /.653 /.654 /.655 /.655-120 /.704 /.706

MSA	Qt.	Kg
99.256	36x	0.030

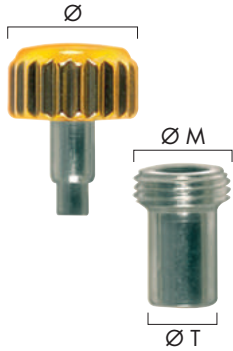

Couronne à vis couleur acier et jaune avec tube et joint, **vissage externe** ; acier inoxydable.

Steel colour and yellow screw-on crown with tube and gasket, **outside screwing** ; stainless steel.









Stahlfarbe und gelbe Schraubkrone mit Rohr und Dichtung, **aussen Gewinde** ; Edelstahl.





Corona de rosca color acero y amarilla con tubo y junta, **rosca externa** ; acero inoxidable.

Corona a vite colore acciaio e gialla con tubo e guarnizione, **filettatura esterna** ; acciaio inossidabile.

Coroa de rosca cor aço e amarela com tubo e junta, **rosca externa** ; aço inoxidável.

MSA	Couleur acier/ Steel colour	Ø mm	Ø M mm	Ø T mm	Ø Tar./Tap. mm	MSA	Jaune/Yellow
60.534		3.50	2.85	1.60	0.90	-	-
-	-	3.50	2.90	2.00	0.90	60.037*	
60.530		3.50	3.00	1.90	0.90	60.030	
60.522		3.50	3.00	1.90	0.90	60.022	
60.501		3.75	3.00	2.00	0.90	60.001	
60.533		4.00	2.85	2.00	0.90	60.033*	
60.502		4.00	3.00	2.00	0.90	60.002	
60.503		4.00	3.00	2.00	0.90	60.003	
60.504		4.50	3.00	2.00	0.90	60.004	
60.505		4.50	3.00	2.00	0.90	60.005	
-	-	4.50	3.40	1.80	0.90	60.029*	
-	-	4.50	3.40	2.00	0.90	60.032*	
60.526		4.50	3.50	2.50	0.90	60.026	
60.525		4.75	3.50	2.50	0.90	60.025	
-	-	4.75	Type P	2.50	0.90	60.045	
60.506		5.00	3.00	2.20	0.90	60.006	
60.507		5.00	3.00	2.20	0.90	60.007	
-	-	5.00	3.40	2.20	0.90	60.035*	
60.514		5.00	3.50	2.50	0.90	60.014	
60.513		5.25	4.00	2.70	0.90	60.013	
60.518**		5.25	Type B	-	0.90	60.018**	
60.519**		5.25	Type B	-	1.20	60.019**	

MSA	Couleur acier/ Steel colour	Ø mm	Ø M mm	Ø T mm	Ø Tar./Tap. mm	MSA	Jaune/Yellow
60.508		5.50	3.00	2.20	0.90	60.008	
60.509		6.00	3.00	2.20	0.90	60.009	
60.510		6.00	3.50	2.50	0.90	60.010	
60.528		6.00	4.00	2.70	0.90	60.028	

60.517		6.00	4.50	3.00	0.90	60.017*	
60.527		6.50	4.50	3.00	0.90	60.027*	

Kg 0.001 * Jusqu'à épuisement des stocks / Will be discontinued after end of stock / Solange Vorrat /
 Hasta agotamiento del stock / Fino ad esaurimento dello stock / Até esgotamento do stock

1/1

** Sans tube / Without tube / Ohne Rohr / Sin tubo / Senza tubo / Sem tubo



Assortiment de couronnes à vis couleur acier et jaunes avec tube et joint, **vissage externe** ; acier inoxydable.

Assortiment of steel colour and yellow screw-on crowns with tube and gasket, **outside screwing** ; stainless steel.

Sortiment von Stahlfarbe und gelbe Schraubkronen mit Rohr und Dichtung, **aussen Gewinde** ; Edelstahl.

Surtido de coronas de rosca color acero y amarillas con tubo y junta, **rosca externa** ; acero inoxidable.

Assortimento di corone a vite colore acciaio e gialle con tubo e guarnizione, **filettatura esterna** ; acciaio inossidabile.

Sortido de coroas de rosca cor aço e amarelas com tubo e junta, **rosca externa** ; aço inoxidável.

**Contenu - Contents - Inhalt - Contenido - Contenuto - Conteúdo :
 12 modèles - models - Modelle - modelos - modelli - modelos
 1x MSA60.002 /.003 /.004 /.016 /.022 /.502 /.503 /.504 /.505
 /.506 /.516 /.522**

MSA	Qt.	Kg
99.011	12x	0.025

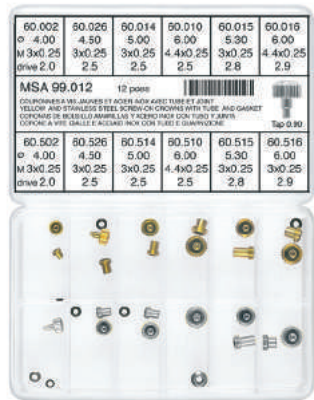

Assortiment de couronnes à vis couleur acier et jaunes avec tube et joint, **vissage externe** ; acier inoxydable.

Assortiment of steel colour and yellow screw-on crowns with tube and gasket, **outside screwing** ; stainless steel.

Sortiment von Stahlfarbe und gelbe Schraubkronen mit Rohr und Dichtung, **aussen Gewinde** ; Edelstahl.

Surtido de coronas de rosca color acero y amarillas con tubo y junta, **rosca externa** ; acero inoxidable.

Assortimento di corone a vite colore acciaio e gialle con tubo e guarnizione, **filettatura esterna** ; acciaio inossidabile.

Sortido de coroas de rosca cor aço e amarelas com tubo e junta, **rosca externa** ; aço inoxidável.

**Contenu - Contents - Inhalt - Contenido - Contenuto - Conteúdo :
 12 modèles - models - Modelle - modelos - modelli - modelos
 1x MSA60.002 /.010 /.014 /.015 /.016 /.026 /.502 /.510 /.514
 /.515 /.516 /.526**

MSA	Qt.	Kg
99.012	12x	0.025

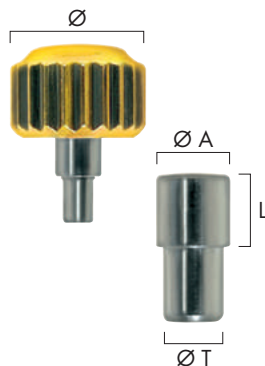

Couronne à vis couleur acier, noire et jaune avec tube et joint, **vissage interne** ; acier inoxydable.

Steel colour, black and yellow screw-on crown with tube and gasket, **inside screwing** ; stainless steel.

Stahlfarbe, schwarze und gelbe Schraubkrone mit Rohr und Dichtung, **innen Gewinde** ; Edelstahl.

Corona de rosca color acero, negra y amarilla con tubo y junta, **rosca interna** ; acero inoxidable.

Corona a vite colore acciaio, nera e gialla con tubo e guarnizione, **filettatura interna** ; acciaio inossidabile.

Coroa de rosca cor aço, preta e amarela com tubo e junta, **rosca interna** ; aço inoxidável.

MSA	Couleur acier / Steel colour	Ø mm	Ø T mm	Ø Tar. / Tap. mm	Ø A mm	L mm	MSA	Noir/Black	MSA	Jaune/Yellow
60.524		4.50	1.80	0.90	2.60	1.80	-	-	60.024	
60.523		5.00	1.80	0.90	2.60	1.80	60.323		60.023	
60.511		5.00	2.50	0.90	3.00	3.00	-	-	60.011	
60.512		5.50	2.50	0.90	3.00	2.90	-	-	60.012	
60.520		6.00	2.50	0.90	3.20	2.70	60.320		-	-
60.521		6.50	2.50	0.90	3.20	2.70	-	-	60.021	

Kg 0.001

1/1

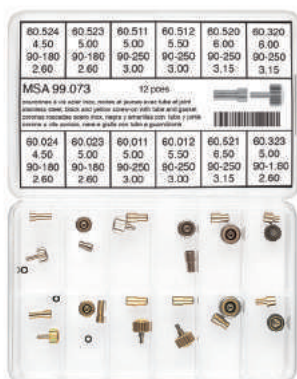

Assortiment de couronnes à vis couleur acier, noires et jaunes avec tube et joint, **vissage interne** ; acier inoxydable.

Assortiment of steel colour, black and yellow screw-on crowns with tube and gasket, **inside screwing** ; stainless steel.

Sortiment von Stahlfarbe, schwarze und gelbe Schraubkronen mit Rohr und Dichtung, **innen Gewinde** ; Edelstahl.

Surtido de coronas de rosca color acero, negras y amarillas con tubo y junta, **rosca interna** ; acero inoxidable.

Assortimento di corone a vite colore acciaio, nere e gialle con tubo e guarnizione, **filettatura interna** ; acciaio inossidabile.

Sortido de coroa de rosca cor aço, pretas e amarelas com tubo e junta, **rosca interna** ; aço inoxidável.

Contenu - Contents - Inhalt - Contenido - Contenuto - Conteúdo :
12 modèles - models - Modelle - modelos - modelli - modelos
1x MSA60.011 /.012 /.023 /.024 /.320 /.323 /.511 /.512 /.520
/.521 /.523 /.524

MSA	Qt.	Kg
99.073	12x	0.025

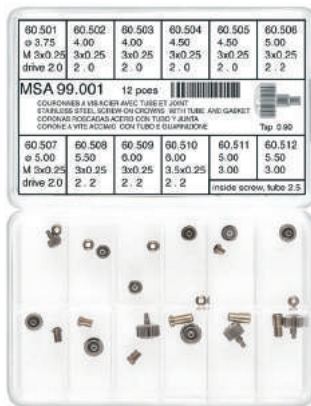

Assortiment de couronnes à vis couleur acier avec tubes et joints, **vissage externe (10x) et interne (2x)**; acier inoxydable.

Assortiment of steel colour screw-on crowns with tubes and gaskets, **outside (10x) and inside (2x) screwing**; stainless steel.

Sortiment von Stahlfarbe Schraubkronen mit Röhre und Dichtungen, **aussen (10x) und innen (2x) Gewinde**; Edelstahl.

Surtido de coronas de rosca color acero con tubos y juntas, **rosca externa (10x) y interna (2x)**; acero inoxidable.

Assortimento di corone a vite colore acciaio con tubi e guarnizioni, **filettatura esterna (10x) e interna (2x)**; acciaio inossidabile.

Sortido de coroas de rosca cor aço com tubos e juntas, **rosca externa (10x) e interna (2x)**; aço inoxidável.

**Contenu - Contents - Inhalt - Contenido - Contenuto - Conteúdo :
 12 modèles - models - Modelle - modelos - modelli - modelos
 1x MSA60.501 /.502 /.503 /.504 /.505 /.506 /.507 /.508 /.509
 /.510 /.511 /.512**

MSA	Qt.	Kg
99.001	12x	0.025

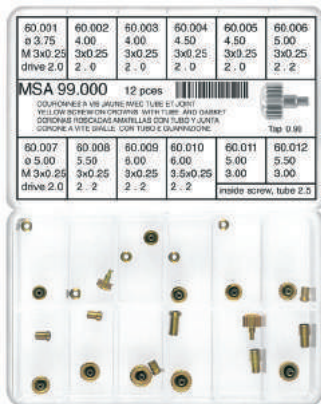

Assortiment de couronnes à vis jaunes avec tubes et joints, **vissage externe (10x) et interne (2x)**; acier inoxydable.

Assortiment of yellow screw-on crowns with tubes and gaskets, **outside (10x) and inside (2x) screwing**; stainless steel.

Sortiment von gelbe Schraubkronen mit Röhre und Dichtungen, **aussen (10x) und innen (2x) Gewinde**; Edelstahl.

Surtido de coronas de rosca amarillas con tubos y juntas, **rosca externa (10x) y interna (2x)**; acero inoxidable.

Assortimento di corone a vite gialle con tubi e guarnizioni, **filettatura esterna (10x) e interna (2x)**; acciaio inossidabile.

Sortido de coroas de rosca amarelas com tubos e juntas, **rosca externa (10x) e interna (2x)**; aço inoxidável.

**Contenu - Contents - Inhalt - Contenido - Contenuto - Conteúdo :
 12 modèles - models - Modelle - modelos - modelli - modelos
 1x MSA60.001 /.002 /.003 /.004 /.005 /.006 /.007 /.008 /.009
 /.010 /.011 /.012**

MSA	Qt.	Kg
99.000	12x	0.026



MSA	Qt.	Kg
99.023	76x	0.336

Assortiment de 76 couronnes à vis couleur acier, noires et jaunes avec tubes et joints + 4 tubes spéciaux, **vissage externe** (62x) et **interne** (14x) ; acier inoxydable.

Assortment of 76 steel colour, black and yellow screw-on crowns with tubes and gaskets + 4 special tubes, **outside** (62x) and **inside** (14x) **screwing** ; stainless steel.

Sortiment von 76 Stahlfarbe, schwarze und gelbe Schraubkronen mit Röhre und Dichtungen + 4 spezielle Röhre, **aussen** (62x) und **innen** (14x) **Gewinde** ; Edelstahl.

Surtido de 76 coronas de rosca color acero, negras y amarillas con tubos y juntas + 4 tubos especiales, **rosca externa** (62x) y **interna** (14x) ; acero inoxidable.

Assortimento di 76 corone a vite colore acciaio, nere e gialle con tubi e guarnizioni + 4 tubi speciali, **filettatura esterna** (62x) e **interna** (14x) ; acciaio inossidabile.

Sortido de 76 coroas de rosca cor aço, pretas e amarelas com tubos e juntas + 4 tubos especiais, **rosca externa** (62x) e **interna** (14x) ; aço inoxidável.

Contenu - Contents - Inhalt - Contenido - Contenuto - Conteúdo :

39 modèles - models - Modelle - modelos - modelli - modelos

1x MSA60.019 /.519

**2x MSA60.001 /.002 /.003 /.004 /.005 /.006 /.007 /.008 /.009 /.010 /.011 /.012 /.013 /.014
 /.015 /.016 /.022 /.323 /.501 /.502 /.503 /.504 /.505 /.506 /.507 /.508 /.509 /.510 /.511 /.512
 /.513 /.514 /.515 /.516 /.520 /.521 /.522**

2x MSA65.001 /.002



Couronne à vis couleur acier et jaune sans tube ; acier inoxydable.
 Steel colour and yellow screw-on crown without tube ; stainless steel.
 Stahlfarbe und gelbe Schraubkrone ohne Rohr ; Edelstahl.
 Corona de rosca color acero y amarilla sin tubo ; acero inoxidable.
 Corona a vite colore acciaio e gialla senza tubo ; acciaio inossidabile.
 Coroa de rosca cor aço e amarela sem tubo ; aço inoxidável.

MSA	Couleur acier/Steel colour	Ø mm	Ø Tar./Tap. mm	Type	MSA	Jaune/Yellow
60.551*		3.50	0.90	Type P	-	-
-	-	4.75	0.90	Type Z	60.055*	
-	-	5.25	0.90	Type C	60.065*	

Kg 0.001 * Jusqu'à épuisement des stocks / Will be discontinued after end of stock / Solange Vorrat /
 Hasta agotamiento del stock / Fino ad esaurimento dello stock / Até esgotamento do stock 1/1

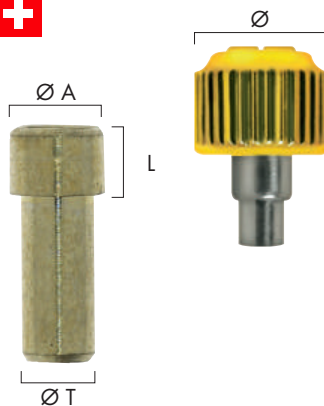

Couronne à vis jaune avec tube et joint, **vissage interne** ; acier inoxydable.
 Yellow screw-on crown with tube and gasket, **inside screwing** ; stainless steel.
 Gelbe Schraubkrone mit Rohr und Dichtung, **innen Gewinde** ; Edelstahl.
 Corona de rosca amarilla con tubo y junta, **rosca interna** ; acero inoxidable.
 Corona a vite gialla con tubo e guarnizione, **filettatura interna** ; acciaio inossidabile.
 Coroa de rosca amarela com tubo e junta, **rosca interna** ; aço inoxidável.

MSA	Jaune/Yellow	Ø mm	Ø T mm	Ø Tar./Tap. mm	Ø A mm	L mm	Type
60.056*		3.50	2.00	0.90	2.60	1.90	Type Z

Kg 0.001 * Jusqu'à épuisement des stocks / Will be discontinued after end of stock / Solange Vorrat /
 Hasta agotamiento del stock / Fino ad esaurimento dello stock / Até esgotamento do stock 1/1

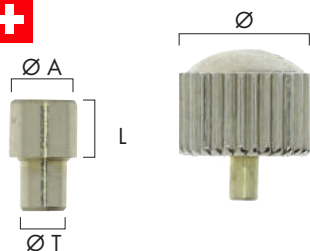

Couronne à vis couleur acier avec tube, **vissage interne** ; acier inoxydable.
 Steel colour screw-on crown with tube, **inside screwing** ; stainless steel.
 Stahlfarbe Schraubkrone mit Rohr, **innen Gewinde** ; Edelstahl.
 Corona de rosca color acero con tubo, **rosca interna** ; acero inoxidable.
 Corona a vite colore acciaio con tubo, **filettatura interna** ; acciaio inossidabile.
 Coroa de rosca cor aço com tubo, **rosca interna** ; aço inoxidável.

MSA	Couleur acier/Steel colour	Ø mm	Ø T mm	Ø Tar./Tap. mm	Ø A mm	L mm
60.548*		6.00	2.20	0.90	3.20	2.90

Kg 0.001 * Jusqu'à épuisement des stocks / Will be discontinued after end of stock / Solange Vorrat /
 Hasta agotamiento del stock / Fino ad esaurimento dello stock / Até esgotamento do stock 1/1



Couronne à vis couleur acier et jaune avec tube et joint, **vissage externe** ; acier inoxydable.

Steel colour and yellow screw-on crown with tube and gasket, **outside screwing** ; stainless steel.







Stahlfarbe und gelbe Schraubkrone mit Rohr und Dichtung, **aussen Gewinde** ; Edelstahl.

Corona de rosca color acero y amarilla con tubo y junta, **rosca externa** ; acero inoxidable.

Corona a vite colore acciaio e gialla con tubo e guarnizione, **filettatura esterna** ; acciaio inossidabile.

Coroa de rosca cor aço e amarela com tubo e junta, **rosca externa** ; aço inoxidável.

MSA	Couleur acier / Steel colour	Ø mm	Ø M mm	Ø T mm	Ø Tar./Tap. mm	MSA	Jaune/Yellow
60.700		3.50	3.00	1.90	0.90	60.600	
60.701		3.75	3.00	2.00	0.90	60.601	
60.702		4.00	3.00	2.00	0.90	60.602	
60.703		4.50	3.00	2.00	0.90	60.603	
60.704		4.50	3.50	2.50	0.90	60.604	
60.705		4.75	3.50	2.50	0.90	60.605	
60.706		4.75	4.00	2.50	0.90	60.606	
60.707		5.00	3.00	2.00	0.90	60.607	
60.708		5.30	4.00	2.80	0.90	60.608	
60.709		5.50	3.50	2.50	0.90	60.609	
60.710		6.00	3.50	2.50	0.90	60.610	
60.711		6.00	4.00	2.70	0.90	60.611	
60.712		6.50	4.00	2.70	0.90	60.612	
60.713		7.00	4.00	2.70	0.90	60.613	
60.714		7.00	4.50	2.30	0.90	60.614	
60.715		7.00	4.50	2.50	0.90	60.615	

MSA	Couleur acier/ Steel colour	Ø mm	Ø M mm	Ø T mm	Ø Tar./Tap. mm	MSA	Jaune/Yellow
60.716		7.50	4.50	2.50	0.90	-	-
60.717		8.00	5.00	2.80	0.90	-	-
60.718		8.50	5.00	3.00	0.90	-	-
60.719		9.00	5.00	3.00	0.90	-	-
60.720		9.50	5.00	3.00	0.90	-	-
60.721		10.00	5.00	3.00	0.90	-	-

Kg 0.001

1/1



MSA	Qt.	Kg
99.243	12x	0.025

Assortiment de couronnes à vis couleur acier avec tubes et joints, **vissage externe** ; acier inoxydable.

Assortiment of steel colour screw-on crowns with tubes and gaskets, **outside screwing** ; stainless steel.

Sortiment von Stahlfarbe Schraubkronen mit Röhre und Dichtungen, **aussen Gewinde** ; Edelstahl.

Surtido de coronas de rosca color acero con tubos y juntas, **rosca externa** ; acero inoxidable.

Assortimento di corone a vite colore acciaio con tubi e guarnizioni, **filettatura esterna** ; acciaio inossidabile.

Sortido de coroas de rosca cor aço com tubos e juntas, **rosca externa** ; aço inoxidável.

Contenu - Contents - Inhalt - Contenido - Contenuto - Conteúdo : 6 modèles - models - Modelle - modelos - modelli - modelos 2x MSA60.700 /.701 /.702 /.703 /.707 /.708



MSA	Qt.	Kg
99.244	12x	0.025

Assortiment de couronnes à vis jaunes avec tubes et joints, **vissage externe** ; acier inoxydable.

Assortiment of yellow screw-on crowns with tubes and gaskets, **outside screwing** ; stainless steel.

Sortiment von gelbe Schraubkronen mit Röhre und Dichtungen, **aussen Gewinde** ; Edelstahl.

Surtido de coronas de rosca amarillas con tubos y juntas, **rosca externa** ; acero inoxidable.

Assortimento di corone a vite gialle con tubi e guarnizioni, **filettatura esterna** ; acciaio inossidabile.

Sortido de coroas de rosca amarelas com tubos e juntas, **rosca externa** ; aço inoxidável.

Contenu - Contents - Inhalt - Contenido - Contenuto - Conteúdo : 6 modèles - models - Modelle - modelos - modelli - modelos 2x MSA60.600 /.601 /.602 /.603 /.607 /.608

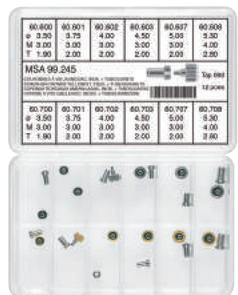

MSA	Qt.	Kg
99.245	12x	0.025

Assortiment de couronnes à vis couleur acier et jaunes avec tubes et joints, **vissage externe** ; acier inoxydable.

Assortiment of steel colour and yellow screw-on crowns with tubes and gaskets, **outside screwing** ; stainless steel.

Sortiment von Stahlfarbe und gelbe Schraubkronen mit Röhre und Dichtungen, **aussen Gewinde** ; Edelstahl.

Surtido de coronas de rosca color acero y amarillas con tubos y juntas, **rosca externa** ; acero inoxidable.

Assortimento di corone a vite colore acciaio e gialle con tubi e guarnizioni, **filettatura esterna** ; acciaio inossidabile.

Sortido de coroas de rosca cor aço e amarelas com tubos e juntas, **rosca externa** ; aço inoxidável.

Contenu - Contents - Inhalt - Contenido - Contenuto - Conteúdo : 12 modèles - models - Modelle - modelos - modelli - modelos 1x MSA60.600 /.601 /.602 /.603 /.607 /.608 /.700 /.701 /.702 /.703 /.707 /.708

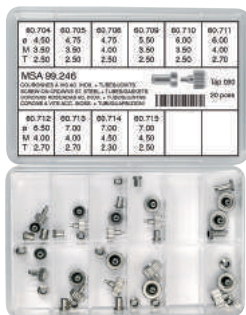

MSA	Qt.	Kg
99.246	20x	0.045

Assortiment de couronnes à vis couleur acier avec tubes et joints, **vissage externe** ; acier inoxydable.

Assortiment of steel colour screw-on crowns with tubes and gaskets, **outside screwing** ; stainless steel.

Sortiment von Stahlfarbe Schraubkronen mit Röhre und Dichtungen, **aussen Gewinde** ; Edelstahl.

Surtido de coronas de rosca color acero con tubos y juntas, **rosca externa** ; acero inoxidable.

Assortimento di corone a vite colore acciaio con tubi e guarnizioni, **filettatura esterna** ; acciaio inossidabile.

Sortido de coroas de rosca cor aço com tubos e juntas, **rosca externa** ; aço inoxidável.

Contenu - Contents - Inhalt - Contenido - Contenuto - Conteúdo : 10 modèles - models - Modelle - modelos - modelli - modelos 2x MSA60.704 /.705 /.706 /.709 /.710 /.711 /.712 /.713 /.714 /.715

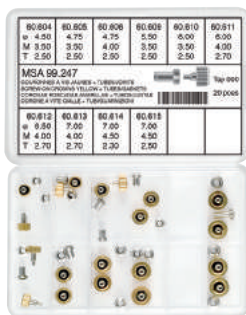

MSA	Qt.	Kg
99.247	20x	0.045

Assortiment de couronnes à vis jaunes avec tubes et joints, **vissage externe** ; acier inoxydable.

Assortiment of yellow screw-on crowns with tubes and gaskets, **outside screwing** ; stainless steel.

Sortiment von gelbe Schraubkronen mit Röhre und Dichtungen, **aussen Gewinde** ; Edelstahl.

Surtido de coronas de rosca amarillas con tubos y juntas, **rosca externa** ; acero inoxidable.

Assortimento di corone a vite gialle con tubi e guarnizioni, **filettatura esterna** ; acciaio inossidabile.

Sortido de coroas de rosca amarelas com tubos e juntas, **rosca externa** ; aço inoxidável

Contenu - Contents - Inhalt - Contenido - Contenuto - Conteúdo : 10 modèles - models - Modelle - modelos - modelli - modelos 2x MSA60.604 /.605 /.606 /.609 /.610 /.611 /.612 /.613 /.614

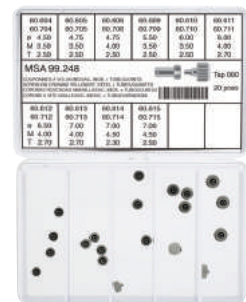

MSA	Qt.	Kg
99.248	20x	0.045

Assortiment de couronnes à vis couleur acier et jaunes avec tubes et joints, **vissage externe** ; acier inoxydable.

Assortiment of steel colour and yellow screw-on crowns with tubes and gaskets, **outside screwing** ; stainless steel.

Sortiment von Stahlfarbe und gelbe Schraubkronen mit Röhre und Dichtungen, **aussen Gewinde** ; Edelstahl.

Surtido de coronas de rosca color acero y amarillas con tubos y juntas, **rosca externa** ; acero inoxidable.

Assortimento di corone a vite colore acciaio e gialle con tubi e guarnizioni, **filettatura esterna** ; acciaio inossidabile.

Sortido de coroas de rosca cor aço e amarelas com tubos e juntas, **rosca externa** ; aço inoxidável.

Contenu - Contents - Inhalt - Contenido - Contenuto - Conteúdo : 20 modèles - models - Modelle - modelos - modelli - modelos 1x MSA60.604 /.605 /.606 /.609 /.610 /.611 /.612 /.613 /.614 /.615 /.704 /.705 /.706 /.709 /.710 /.711 /.712 /.713 /.714 /.715

60.710	60.711	60.712	60.713	60.714	60.715
ø 4.00	6.00	8.50	7.00	7.00	7.00
M 3.50	4.00	4.00	4.00	4.50	4.50
T 2.50	2.70	2.70	2.70	2.30	2.50

MSA 99.249

CONTENIDO A VIBRADO Y UNIZADO AL 100%
CONTENUTO VIBRATA E UNIZATA AL 100%
CONTENIDA VIBRADA CON UNIZADA AL 100%
CONTENIDA A VITE CON UNIZADA AL 100%
Tap 090

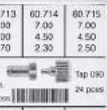

Assortiment de couronnes à vis couleur acier avec tubes et joints, **vissage externe** ; acier inoxydable.

Assortiment of steel colour screw-on crowns with tubes and gaskets, **outside screwing** ; stainless steel.

Sortiment von Stahlfarbe Schraubkronen mit Röhre und Dichtungen, **aussen Gewinde** ; Edelstahl.

Surtido de coronas de rosca color acero con tubos y juntas, **rosca externa** ; acero inoxidable.

Assortimento di corone a vite colore acciaio con tubi e guarnizioni, **filettatura esterna** ; acciaio inossidabile.

Sortido de coroas de rosca cor aço com tubos e juntas, **rosca externa** ; aço inoxidável.

Contenu - Contents - Inhalt - Contenido - Contenuto - Conteúdo :
12 modèles - models - Modelle - modelos - modelli - modelos
2x MSA60.710 /.711 /.712 /.713 /.714 /.715 /.716 /.717 /.718
/.719 /.720 /.721

MSA	Qt.	Kg
99.249	24x	0.050

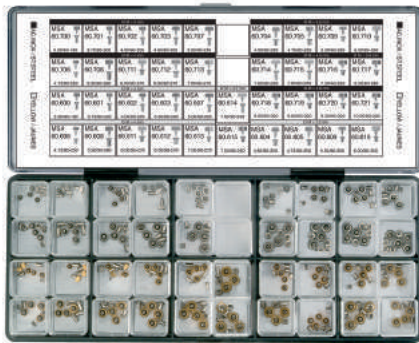

MSA	Qt.	Kg
99.250	152x	0.490

Assortiment de couronnes à vis couleur acier et jaunes avec tubes et joints, **vissage externe** ; acier inoxydable.

Assortiment of steel colour and yellow screw-on crowns with tubes and gaskets, **outside screwing** ; stainless steel.

Sortiment von Stahlfarbe und gelbe Schraubkronen mit Röhre und Dichtungen, **aussen Gewinde** ; Edelstahl.

Surtido de coronas de rosca color acero y amarillas con tubos y juntas, **rosca externa** ; acero inoxidable.

Assortimento di corone a vite colore acciaio e gialle con tubi e guarnizioni, **filettatura esterna** ; acciaio inossidabile.

Sortido de coroas de rosca cor aço e amarelas com tubos e juntas, **rosca externa** ; aço inoxidável.

Contenu - Contents - Inhalt - Contenido - Contenuto - Conteúdo :
38 modèles - models - Modelle - modelos - modelli - modelos
4x MSA60.600 /.601 /.602 /.603 /.604 /.605 /.606 /.607 /.608 /.609 /.610 /.611 /.612 /.613
/.614 /.615 /.700 /.701 /.702 /.703 /.704 /.705 /.706 /.707 /.708 /.709 /.710 /.711 /.712 /.713
/.714 /.715 /.716 /.717 /.718 /.719 /.720 /.721



Couronne à vis couleur acier et jaune avec tube et joint, **vissage externe** ; palladium.

Steel colour and yellow screw-on crown with tube and gasket, **outside screwing** ; palladium.

Stahlfarbe und gelbe Schraubkrone mit Rohr und Dichtung, **aussen Gewinde** ; Palladium.

Corona de rosca color acero y amarilla con tubo y junta, **rosca externa** ; paladio.

Corona a vite colore acciaio e gialla con tubo e guarnizione, **filettatura esterna** ; palladio.

Coroa de rosca cor aço e amarela com tubo e junta, **rosca externa** ; paládio.

MSA	Couleur acier/ Steel colour	Ø mm	Ø M mm	Ø T mm	Ø Tar./Tap. mm	MSA	Jaune/Yellow
60.901*		3.75	3.00	2.00	0.90	-	-
60.902*		4.00	3.00	2.00	0.90	60.802*	
60.904*		4.50	3.00	2.00	0.90	60.804*	
60.926*		4.50	3.50	2.50	0.90	60.826*	
-	-	4.75	3.50	2.50	0.90	60.825*	
-	-	4.75	4.00	2.50	0.90	60.845*	
60.906*		5.00	3.00	2.20	0.90	60.806*	
60.915*		5.30	4.00	2.80	0.90	60.815*	
-	-	5.50	3.50	2.50	0.90	60.860*	
-	-	6.00	3.50	2.50	0.90	60.810*	
-	-	6.00	4.00	2.70	0.90	60.828*	
60.961*		6.50	4.00	2.70	0.90	60.861*	
-	-	7.00	4.00	2.70	0.90	60.862*	
-	-	7.00	4.50	2.30	0.90	60.864*	
-	-	7.00	4.50	2.50	0.90	60.863*	

Kg 0.001 * Jusqu'à épuisement des stocks / Will be discontinued after end of stock / Solange Vorrat /
Hasta agotamiento del stock / Fino ad esaurimento dello stock / Até esgotamento do stock

1/1



ZE

Couronne antipoussière couleur acier, jaune et rose ; acier inoxydable.
 Steel colour, yellow and pink dustproof crown ; stainless steel.
 Stahlfarbe, gelbe und rosa staubgeschützter Krone ; Edelstahl.
 Corona antipolvo color acero, amarilla y rosada ; acero inoxidable.
 Corona antipolvere colore acciaio, gialla e rosa ; acciaio inossidabile.
 Coroa anti-poeira cor aço, amarela e cor de rosa ; aço inoxidável.

MSA	Couleur acier/Steel colour	Ø mm	Ø Tar./Tap. mm	MSA	Jaune/Yellow	MSA	Rose/Pink
-	-	3.00	0.90	85.001		-	-
85.042		3.50	0.90	85.002		85.082	
85.043		3.75	0.90	85.003		-	-
85.044		4.00	0.90	85.004		85.084	
-	-	4.00	1.00	85.007		-	-
85.045		4.50	0.90	85.005		85.085	
-	-	4.50	1.00	85.008		85.088	
85.046		5.00	0.90	85.006		85.086	
-	-	5.00	1.00	85.009		85.089	

Kg 0.001

1/1



ZE

Couronne chrono couleur acier, jaune et rose ; acier inoxydable.
 Steel colour, yellow and pink chrono crown ; stainless steel.
 Stahlfarbe, gelbe und rosa Chrono Krone ; Edelstahl.
 Corona crono color acero, amarilla y rosada ; acero inoxidable.
 Corona crono colore acciaio, gialla e rosa ; acciaio inossidabile.
 Coroa crono cor aço, amarela e cor de rosa ; aço inoxidável.

MSA	Couleur acier/Steel colour	Ø mm	Ø Tar./Tap. mm	MSA	Jaune/Yellow	MSA	Rose/Pink
85.050		5.70	1.20	85.010		85.090	

Kg 0.001

1/1

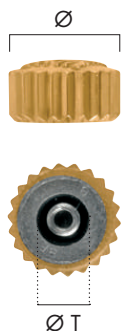

ZE

Couronne étanche couleur acier, jaune et rose ; acier inoxydable.

Steel colour, yellow and pink waterproof crown ; stainless steel.

Stahlfarbe, gelbe und rosa wasserdichter Krone ; Edelstahl.

Corona hermética color acero, amarilla y rosada ; acero inoxidable.

Corona impermeabile colore acciaio, gialla e rosa ; acciaio inossidabile.

Coroa estanque cor aço, amarela e cor de rosa ; aço inoxidável.

MSA	Couleur acier / Steel colour	Ø mm	Ø T mm	Ø Tar./ Tap. mm	MSA	Jaune/ Yellow	MSA	Rose/ Pink
-	-	3.50	2.00	0.90	85.011		-	-
85.052		4.00	2.00	0.90	85.012		85.092	
85.053		4.50	2.00	0.90	85.013		85.093	
85.054		4.50	2.50	0.90	85.014		85.094	
85.055		5.00	2.00	0.90	85.015		85.095	
85.056		5.00	2.50	0.90	85.016		85.096	
85.057		5.00	2.50	1.00	-	-	-	-

Kg 0.001

1/1



Type MID

Couronne + tigeon couleur acier et jaune ; acier inoxydable.

Steel colour and yellow crown + pivot-shank ; stainless steel.

Stahlfarbe und gelbe Krone + Tigeon ; Edelstahl.

Corona + tijita color acero y amarilla ; acero inoxidable.

Corona + albero a strappo colore acciaio e gialla ; acciaio inossidabile.

Coroa + tiginha cor aço e amarela ; aço inoxidável.

MSA	Couleur acier/Steel colour	Ø mm	Ø Tar./Tap. mm	MSA	Jaune/Yellow
85.401*		4.25	0.90	-	-
56.500-8479**		Longueur/Length : 3 mm			

Kg 0.001 * Jusqu'à épuisement des stocks / Will be discontinued after end of stock / Solange Vorrat / Hasta agotamiento del stock / Fino ad esaurimento dello stock / Até esgotamento do stock

** Tigeon femelle / Female pivot-shank / Muttertigion / Tijita hembra / Albero a strappo femmine / Tiginha fêmea



LG

Couronne antipoussière couleur acier et jaune ; acier inoxydable.
 Steel colour and yellow dustproof crown ; stainless steel.
 Stahlfarbe und gelbe staubgeschützter Krone ; Edelstahl.
 Corona antipolvo color acero y amarilla ; acero inoxidable.
 Corona antipolvere colore acciaio e gialla ; acciaio inossidabile.
 Coroa anti-poeira cor aço e amarela ; aço inoxidável.

MSA	Couleur acier/Steel colour	Ø mm	Ø Tar./Tap. mm	Dôme/Dome	MSA	Jaune/Yellow
-	-	3.25	0.90	Bas/Low	85.101*	
85.202*		3.50	0.90	Bas/Low	85.102*	
85.203*		3.50	0.90	-	85.103*	
85.204*		3.75	0.90	Bas/Low	-	-
85.205*		3.75	0.90	-	-	-
85.206*		3.75	0.90	Haut/High	85.106*	
85.207*		4.00	0.90	Bas/Low Canon long/Long pipe	85.107*	
85.209*		4.00	0.90	-	85.109*	
-	-	4.00	0.90	Haut/High	85.110*	
85.211*		4.25	0.90	-	-	-
-	-	4.50	0.90	Bas/Low	85.112*	
-	-	5.00	0.90	Bas/Low	85.115*	

Kg 0.001 * Jusqu'à épuisement des stocks / Will be discontinued after end of stock / Solange Vorrat / Hasta agotamiento del stock / Fino ad esaurimento dello stock / Até esgotamento do stock 1/1



LG

Couronne simple couleur acier et jaune ; acier inoxydable.
 Steel colour and yellow regular crown ; stainless steel.
 Stahlfarbe und gelbe einfache Krone ; Edelstahl.
 Corona sencilla color acero y amarilla ; acero inoxidable.
 Corona semplice colore acciaio e gialla ; acciaio inossidabile.
 Coroa simples cor aço e amarela ; aço inoxidável.

MSA	Couleur acier/Steel colour	Ø mm	Ø Tar./Tap. mm	Dôme/Dome	MSA	Jaune/Yellow
85.216*		3.00	0.80	-	85.116*	
-	-	3.00	0.90	-	85.117*	
85.218*		4.00	0.90	-	85.118*	
-	-	4.50	0.90	-	85.119*	

Kg 0.001 * Jusqu'à épuisement des stocks / Will be discontinued after end of stock / Solange Vorrat / Hasta agotamiento del stock / Fino ad esaurimento dello stock / Até esgotamento do stock 1/1



LG

Couronne étanche couleur acier et jaune ; acier inoxydable.
 Steel colour and yellow waterproof crown ; stainless steel.
 Stahlfarbe und gelbe wasserdichter Krone ; Edelstahl.
 Corona hermética color acero y amarilla ; acero inoxidable.
 Corona impermeabile colore acciaio e gialla ; acciaio inossidabile.
 Coroa estanque cor aço e amarela ; aço inoxidável.

MSA	Couleur acier/Steel colour	Ø mm	Ø T mm	Ø Tar./Tap. mm	Dôme/Dome	MSA	Jaune/Yellow
-	-	3.75	2.00	0.90	-	85.122*	
-	-	4.00	2.00	0.90	Bas/Low Canon long/Long pipe	85.123*	
-	-	4.00	2.00	0.90	Bas/Low	85.124*	
85.226*		4.00	2.00	0.90	Haut/High Canon long/Long pipe	-	-
85.229*		4.50	2.00	0.90	Bas/Low Canon long/Long pipe	-	-
85.230*		4.50	2.00	0.90	-	85.130*	
-	-	4.50	2.00	0.90	Haut/High Canon long/Long pipe	85.131*	
-	-	4.50	2.00	1.00	Haut/High	85.137*	
-	-	5.00	2.00	0.90	Bas/Low	85.133*	
85.234*		5.00	2.00	0.90	-	85.134*	
85.236*		5.00	2.00	1.00	Haut/High	-	-
85.238*		5.50	2.50	1.20	Haut/High	-	-

Kg 0.001 * Jusqu'à épuisement des stocks / Will be discontinued after end of stock / Solange Vorrat / Hasta agotamiento del stock / Fino ad esaurimento dello stock / Até esgotamento do stock 1/1



LG

Couronne à vis couleur acier ; acier inoxydable.
 Steel colour screw-on crown ; stainless steel.
 Stahlfarbe Schraubkrone ; Edelstahl.
 Corona de rosca color acero ; acero inoxidable.
 Corona a vite colore acciaio ; acciaio inossidabile.
 Coroa de rosca cor aço ; aço inoxidável.

MSA	Couleur acier/Steel colour	Ø mm	Ø Tar./Tap. mm	MSA	Jaune/Yellow
85.240*		4.50	0.90	-	-

Kg 0.001 * Jusqu'à épuisement des stocks / Will be discontinued after end of stock / Solange Vorrat / Hasta agotamiento del stock / Fino ad esaurimento dello stock / Até esgotamento do stock 1/1



OM

Couronne antipoussière jaune et rose ; acier inoxydable.
 Yellow and pink dustproof crown ; stainless steel.
 Gelbe und rosa staubgeschützter Krone ; Edelstahl.
 Corona antipolvo amarilla y rosada ; acero inoxidable.
 Corona antipolvere gialla e rosa ; acciaio inossidabile.
 Coroa anti-poeira amarela e cor de rosa ; aço inoxidável.

MSA	Couleur acier/Steel colour	Ø mm	Ø Tar./Tap. mm	Hauteur/Height mm	MSA	Jaune/Yellow	MSA	Rose/Pink
-	-	3.75	0.90	1.60	85.603*		85.703*	
-	-	4.50	0.90	1.60	85.606*		-	-

Kg 0.001 * Jusqu'à épuisement des stocks / Will be discontinued after end of stock / Solange Vorrat / Hasta agotamiento del stock / Fino ad esaurimento dello stock / Até esgotamento do stock 1/1



OM

Couronne étanche couleur acier et jaune ; acier inoxydable.
 Steel colour and yellow waterproof crown ; stainless steel.
 Stahlfarbe und gelbe wasserdichter Krone ; Edelstahl.
 Corona hermética color acero y amarilla ; acero inoxidable.
 Corona impermeabile colore acciaio e gialla ; acciaio inossidabile.
 Coroa estanque cor aço e amarela ; aço inoxidável.

MSA	Couleur acier/Steel colour	Ø mm	Ø T mm	Ø Tar./Tap. mm	Hauteur/Height mm	MSA	Jaune/Yellow
-	-	3.75	2.00	0.90	3.80	85.611*	
-	-	4.00	2.00	0.90	2.70	85.614*	
-	-	4.10	2.00	0.90	2.00	85.619*	
-	-	4.50	2.00	0.90	2.70	85.618*	
85.520*		4.75	2.00	0.90	2.80	-	-
-	-	5.50	2.50	0.90	3.70	85.627*	

Kg 0.001 * Jusqu'à épuisement des stocks / Will be discontinued after end of stock / Solange Vorrat / Hasta agotamiento del stock / Fino ad esaurimento dello stock / Até esgotamento do stock 1/1



1000
pcs

Couronne de travail ; blanche et jaune.

Working crown ; white and yellow.

Arbeitskrone ; weisse und gelbe.

Corona de trabajo ; blanca y amarilla.

Corona di lavoro ; bianca e gialla.

Coroa de trabalho ; branca e amarela.

MSA	1/1	Ø mm	Ø Tar./Tap. mm	Kg
87.000-070		5.00	0.70	0.060
87.000-080		5.00	0.80	0.060
87.000-090		5.00	0.90	0.060
87.000-120		5.00	1.20	0.060

Kg 0.001

1/1

A large area of horizontal dotted lines for writing notes, spanning most of the page's width and height. The lines are evenly spaced and extend across the page from left to right.

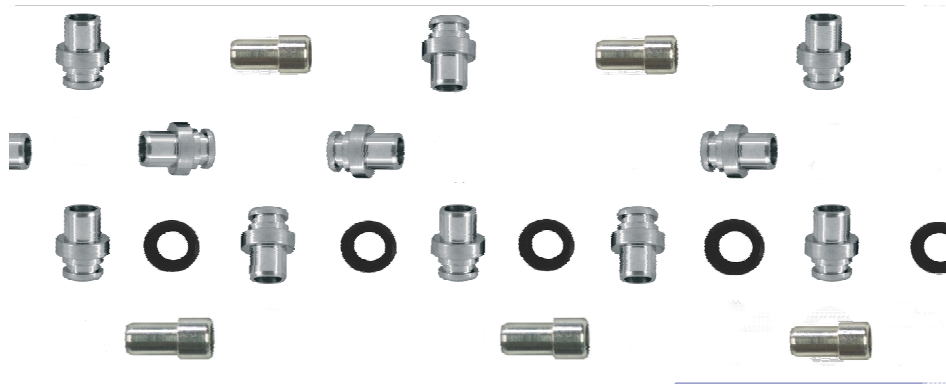

TUBES ■ TUBES ■ RÖHRE
TUBOS ■ TUBI

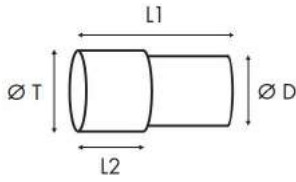

Tube en acier inoxydable pour boîtes étanches.
Stainless steel tube for waterproof cases.
Rohr aus Edelstahl für wasserdichte Gehäuse.
Tubo en acero inoxidable para cajas herméticas.
Tubo in acciaio inossidabile per casse impermeabili.

100 pièces / pieces / Stück / piezas / pezzi

MSA	Ø T mm	Ø D mm	L1 mm	L2 mm	Kg	MSA	Ø T mm	Ø D mm	L1 mm	L2 mm	Kg
47.003-25A	1.30	-	2.00	-	0.001	47.003-01	2.50	1.90	3.20	1.90	0.005
47.003-34	1.50	1.40	2.40	1.20	0.001	47.003-02	2.50	1.90	3.85	1.90	0.005
47.003-35	1.50	1.40	2.50	1.20	0.001	47.003-03	2.50	1.90	4.95	1.90	0.006
47.003-27	1.60	1.50	2.20	1.20	0.001	47.003-04	2.50	1.90	5.05	1.90	0.006
47.003-29	1.60	1.50	2.30	1.20	0.002	47.003-05	2.50	2.00	3.55	1.90	0.006
47.003-30	1.60	1.50	2.40	1.20	0.002	47.003-06	2.50	2.00	4.25	1.90	0.006
47.003-26	1.60	1.50	2.50	1.20	0.002	47.003-07	2.50	2.00	4.45	1.90	0.006
47.003-33	1.60	1.50	2.60	1.40	0.002	47.003-08	2.50	2.00	4.75	1.90	0.006
47.003-28	1.60	1.50	2.70	1.20	0.002	47.003-09	2.50	2.20	3.20	1.90	0.006
47.003-31	1.60	1.50	2.70	1.40	0.002	47.003-10	2.50	2.20	3.50	1.90	0.006
47.003-32	1.60	1.50	3.00	1.40	0.002	47.003-11	2.50	2.20	4.05	1.90	0.007
47.003-36A	1.80	1.60	2.80	1.50	0.002	47.003-12	2.50	2.20	4.35	1.90	0.008
47.003-13	2.00	1.80	2.40	1.15	0.003	47.003-37	3.00	1.90	3.20	1.90	0.010
47.003-15	2.00	1.80	2.40	1.50	0.003	47.003-38	3.00	1.90	3.85	1.90	0.010
47.003-14	2.00	1.80	2.80	1.15	0.003	47.003-39	3.00	2.00	4.95	2.20	0.010
47.003-16	2.00	1.80	3.30	1.50	0.003	47.003-40	3.00	2.00	5.50	2.20	0.010
47.003-17	2.00	1.80	3.90	1.50	0.004	47.003-41	3.00	2.50	3.85	2.50	0.010
47.003-18	2.00	1.80	4.50	1.50	0.004	47.003-42	3.00	2.50	5.50	2.50	0.010
47.003-21	2.00	1.90	3.00	1.50	0.004	47.003-43	3.50	2.00	3.90	1.90	0.010
47.003-19	2.00	1.90	3.30	1.15	0.004	47.003-44	3.50	2.00	4.95	1.90	0.010
47.003-22	2.00	1.90	3.60	1.50	0.004	47.003-45	3.50	2.50	5.20	2.20	0.010
47.003-20	2.00	1.90	3.80	1.15	0.004	47.003-46	3.50	2.50	5.50	2.20	0.010
47.003-23	2.00	1.90	4.20	1.50	0.005	47.003-47	3.50	3.00	1.60	2.50	0.010
47.003-24	2.00	1.90	4.80	1.50	0.005	47.003-48	3.50	3.00	6.50	2.50	0.010



MSA	Qté. / Qty.	Kg
47.002	144x	0.029

Assortiment de tubes en acier inoxydable pour boîtes étanches.
Assortment of stainless steel tubes for waterproof cases.
Sortiment von Röhre aus Edelstahl für wasserdichte Gehäuse.
Sortido de tubos en acero inoxidable para cajas herméticas.
Assortimento di tubi in acciaio inossidabile per casse impermeabili.

Ø 1.30 - 1.50 - 1.60 - 1.80 mm



Contenu - Contents - Inhalt - Contenido - Contenuto : 12 modèles - models - Modelle - modelos - modelli
12x MSA47.003-25A -26 -27 -28 -29 -30 -31 -32 -33 -34 -35 -36A



MSA	Qté. / Qty.	Kg
47.001	144x	0.033

Assortiment de tubes en acier inoxydable pour boîtes étanches.
Assortment of stainless steel tubes for waterproof cases.
Sortiment von Röhre aus Edelstahl für wasserdichte Gehäuse.
Surtido de tubos en acero inoxidable para cajas herméticas.
Assortimento di tubi in acciaio inossidabile per casse impermeabili.

Ø 2.00 mm



Contenu - Contents - Inhalt - Contenido - Contenuto : 12 modèles - models - Modelle - modelos - modelli
12x MSA47.003-13 -14 -15 -16 -17 -18 -19 -20 -21 -22 -23 -24



MSA	Qté. / Qty.	Kg
47.000	144x	0.036

Assortiment de tubes en acier inoxydable pour boîtes étanches.
Assortment of stainless steel tubes for waterproof cases.
Sortiment von Röhre aus Edelstahl für wasserdichte Gehäuse.
Surtido de tubos en acero inoxidable para cajas herméticas.
Assortimento di tubi in acciaio inossidabile per casse impermeabili.

Ø 2.50 mm



Contenu - Contents - Inhalt - Contenido - Contenuto : 12 modèles - models - Modelle - modelos - modelli
12x MSA47.003-01 -02 -03 -04 -05 -06 -07 -08 -09 -10 -11 -12



MSA	Qté. / Qty.	Kg
47.005	144x	0.033

Assortiment de tubes en acier inoxydable pour boîtes étanches.
Assortment of stainless steel tubes for waterproof cases.
Sortiment von Röhre aus Edelstahl für wasserdichte Gehäuse.
Surtido de tubos en acero inoxidable para cajas herméticas.
Assortimento di tubi in acciaio inossidabile per casse impermeabili.

Ø 3.00 - 3.50 mm



Contenu - Contents - Inhalt - Contenido - Contenuto : 12 modèles - models - Modelle - modelos - modelli
12x MSA47.003-37 -38 -39 -40 -41 -42 -43 -44 -45 -46 -47 -48

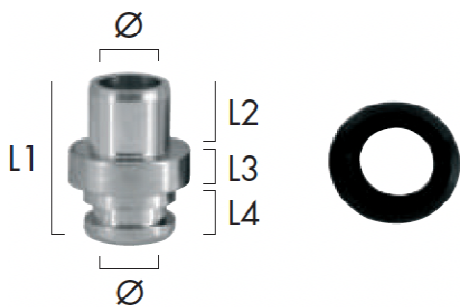

MSA	Ø int. mm	L1 mm	L2 mm	L3 mm	L4 mm	Kg
47.101	1.27	2.50	1.00	0.29	1.21	0.001

Tube spécial en acier inoxydable pour couronnes, avec joint MSA43.006.
 Stainless steel special crown tube, with gasket MSA43.006.
 Spezieller Rohr aus Edelstahl für Kronen, mit Dichtung MSA43.006.
 Tubo especial en acero inoxidable para coronas, con junta MSA43.006.
 Tubo speciale in acciaio inossidabile per corone, con guarnizione MSA43.006.

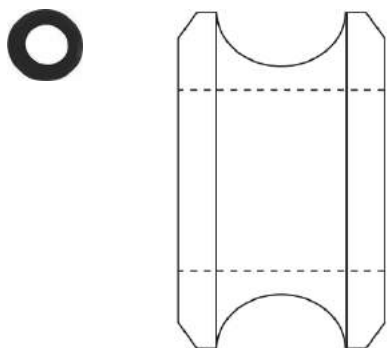

MSA	Ø int./ext. mm	Kg
43.006	1.50 x 2.80	0.001

Joint pour tube spécial en acier inoxydable MSA47.101 ; sachet de 10 pièces.
 Gasket for stainless steel special tube MSA47.101 ; bag of 10 pieces.
 Dichtung für spezieller Rohr aus Edelstahl MSA47.101 ; Beutel von 10 Stück.
 Junta para tubo especial en acero inoxidable MSA47.101 ; bolsita de 10 piezas.
 Guarnizione per tubo speciale in acciaio inossidabile MSA47.101 ; bustina da 10 pezzi.

10 pièces / pieces / Stück / piezas / pezzi



POUSOIRS

PUSHERS

DRÜCKER

PULSADORES

PULSANTI

BOTÕES

Poussoirs à chasser
Press-in pushers
Drücker zum einpressen
Pulsadores a presión
Pulsanti a pressione
Botões de pressão



2

Poussoirs à visser
Screw-on pushers
Drücker zum schrauben
Pulsadores de rosca
Pulsanti a vite
Botões de rosca

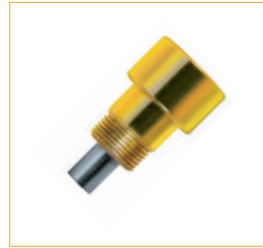

10

Poussoirs rectangulaires
Rectangular pushers
Rechteckiger Drücker
Pulsadores rectangulares
Pulsanti rettangolari
Botões rectangulares



11

Poussoirs spéciaux
Special pushers
Spezielle Drücker
Pulsadores especiales
Pulsanti speciali
Botões especiais



12

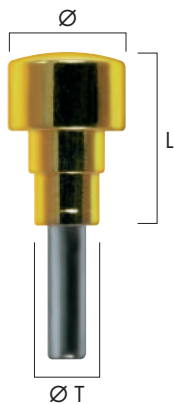

Poussoir à chasser étanche couleur acier, jaune et rose, **forme cylindrique** ; acier inoxydable.

Steel colour, yellow and pink waterproof press-in pusher, **cylindrical shape** ; stainless steel.

Stahlfarbe, gelber und rosa wasserdichter Drücker zum einpressen, **zylindrische Form** ; Edelstahl.

Pulsador a presión hermético color acero, amarillo y rosado, **forma cilíndrica** ; acero inoxidable.

Pulsante impermeabile a pressione colore acciaio, giallo e rosa, **forma cilindrica** ; acciaio inossidabile.

Botão à pressão estanque cor aço, amarelo e cor de rosa, **forma cilíndrica** ; aço inoxidável.

MSA	Couleur acier / Steel colour	Ø mm	Ø T mm	L mm	MSA	Jaune/ Yellow	MSA	Rose/ Pink
61.401		2.30	1.80	5.50	61.801		-	-
61.402		3.00	2.00	5.50	61.802		-	-
61.405		3.00	2.20	5.00	61.805		-	-
61.403		3.50	2.00	6.00	61.803		-	-
61.406		3.50	2.50	5.00	61.806		-	-
61.407		3.50	2.50	6.00	61.807		-	-
-	-	4.00	1.50	6.10	-	-	61.908	
61.404		4.00	2.00	5.00	61.804		-	-
61.408		4.00	2.50	6.00	61.808		-	-
61.410		4.00	2.60	6.50	61.810		-	-
61.409		4.50	2.50	6.50	61.809		-	-
61.413		5.00	2.50	6.50	61.813		-	-
61.414		5.50	2.60	6.70	61.814		-	-
61.415		6.00	2.60	6.70	61.815		-	-

Kg 0.001

1/1



MSA	Qt.	Kg
99.232	24x	0.034

Assortiment de poussoirs à chasser étanches couleur acier, **forme cylindrique** ; acier inoxydable.

Assortiment of steel colour waterproof press-in pushers, **cylindrical shape** ; stainless steel.

Sortiment von Stahlfarbe wasserdichte Drücker zum einpressen, **zylindrische Form** ; Edelstahl.

Surtido de pulsadores a presión herméticos color acero, **forma cilíndrica** ; acero inoxidable.

Assortimento di pulsanti impermeabili a pressione colore acciaio, **forma cilindrica** ; acciaio inossidabile.

Sortido de botões à pressão estanques cor aço, **forma cilíndrica** ; aço inoxidável.

**Contenu - Contents - Inhalt - Contenido - Contenuto - Conteúdo :
 12 modèles - models - Modelle - modelos - modelli - modelos
 2x MSA61.402 / .403 / .404 / .405 / .406 / .407 / .408 / .409 / .410 / .413 / .414 / .415**



MSA	Qt.	Kg
99.233	24x	0.034

Assortiment de poussoirs à chasser étanches jaunes, **forme cylindrique** ; acier inoxydable.

Assortiment of yellow waterproof press-in pushers, **cylindrical shape** ; stainless steel.

Sortiment von gelbe wasserdichte Drücker zum einpressen, **zylindrische Form** ; Edelstahl.

Surtido de pulsadores a presión herméticos amarillos, **forma cilíndrica** ; acero inoxidable.

Assortimento di pulsanti impermeabili a pressione gialli, **forma cilindrica** ; acciaio inossidabile.

Sortido de botões à pressão estanques amarelos, **forma cilíndrica** ; aço inoxidável.

**Contenu - Contents - Inhalt - Contenido - Contenuto - Conteúdo :
 12 modèles - models - Modelle - modelos - modelli - modelos
 2x MSA61.802 / .803 / .804 / .805 / .806 / .807 / .808 / .809 / .810 / .813 / .814 / .815**

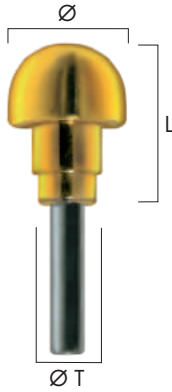

Poussoir à chasser étanche couleur acier et jaune, **forme demi-boule** ; acier inoxydable.

Steel colour and yellow waterproof press-in pusher, **domed shape** ; stainless steel.

Stahlfarbe und gelber wasserdichter Drücker zum einpressen, **Halbkugel Form** ; Edelstahl.

Pulsador a presión hermético color acero y amarillo, **forma media bola** ; acero inoxidable.

Pulsante impermeabile a pressione colore acciaio e giallo, **forma demiboule** ; acciaio inossidabile.

Botão de pressão estanque cor aço e amarelo, **forma meia bola** ; aço inoxidável.

MSA	Couleur acier/Steel colour	Ø mm	Ø T mm	L mm	MSA	Jaune/Yellow
61.601		3.00	1.80	4.30	61.101	
61.602		3.00	2.00	4.80	61.102	
61.603		3.00	2.00	5.00	61.103	
61.604		3.00	2.00	5.10	61.104	
61.605		3.00	2.00	5.25	61.105	
61.606		3.00	2.00	5.60	61.106	
61.607		3.50	2.00	5.20	61.107	
61.608		3.50	2.00	5.60	61.108	
61.609		3.50	2.00	6.10	61.109	
61.654		3.50	2.20	5.50	61.154	
61.655		3.50	2.50	5.20	61.155	
61.651		4.00	2.00	4.90	61.151	
61.652		4.00	2.00	5.40	61.152	
61.653		4.00	2.00	5.90	61.153	
61.656		4.00	2.50	5.70	61.156	
61.657		4.00	2.50	6.20	61.157	
61.658		4.00	2.50	7.30	61.158	
61.659		5.00	2.50	8.30	61.159	
61.660		5.50	2.60	7.00	61.160	
61.661		6.00	2.60	7.60	61.161	

Kg 0.001

1/1



MSA	Qt.	Kg
99.230	36x	0.046

Assortiment de poussoirs à chasser étanches couleur acier, **forme demi-boule** ; acier inoxydable.

Assortment of steel colour waterproof press-in pushers, **domed shape** ; stainless steel.

Sortiment von Stahlfarbe wasserdichte Drücker zum einpressen, **Halbkugel Form** ; Edelstahl.

Surtido de pulsadores a presión herméticos color acero, **forma media bola** ; acero inoxidable.

Assortimento di pulsanti impermeabili a pressione colore acciaio, **forma demiboule** ; acciaio inossidabile.

Sortido de botões de pressão estanques cor aço, **forma meia bola** ; aço inoxidável.

**Contenu - Contents - Inhalt - Contenido - Contenuto - Conteúdo :
18 modèles - models - Modelle - modelos - modelli - modelos
2x MSA61.602 / .604 / .605 / .606 / .607 / .608 / .609 / .651 / .652
/ .653 / .654 / .655 / .656 / .657 / .658 / .659 / .660 / .661**



MSA	Qt.	Kg
99.231	36x	0.047

Assortiment de poussoirs à chasser étanches jaunes, **forme demi-boule** ; acier inoxydable.

Assortment of yellow waterproof press-in pushers, **domed shape** ; stainless steel.

Sortiment von gelbe wasserdichte Drücker zum einpressen, **Halbkugel Form** ; Edelstahl.

Surtido de pulsadores a presión herméticos amarillos, **forma media bola** ; acero inoxidable.

Assortimento di pulsanti impermeabili a pressione gialli, **forma demiboule** ; acciaio inossidabile.

Sortido de botões de pressão estanques amarelos, **forma meia bola** ; aço inoxidável.

**Contenu - Contents - Inhalt - Contenido - Contenuto - Conteúdo :
18 modèles - models - Modelle - modelos - modelli - modelos
2x MSA61.102 / .104 / .105 / .106 / .107 / .108 / .109 / .151 / .152
/ .153 / .154 / .155 / .156 / .157 / .158 / .159 / .160 / .161**



Poussoir à chasser étanche couleur acier et jaune, **forme antique** ; acier inoxydable.

Steel colour and yellow wyaterproof press-in pusher, **antique shape** ; stainless steel.

Stahlfarbe und gelber wasserdichter Drücker zum einpressen, **Antiker Form** ; Edelstahl.

Pulsador a presión hermético color acero y amarillo, **forma antigua** ; acero inoxidable.

Pulsante a pressione impermeabile colore acciaio e giallo, **forma antica** ; acciaio inossidabile.

Botão de pressão estanque cor aço e amarelo, **forma antiga** ; aço inoxidável.

MSA	Couleur acier/Steel colour	Ø mm	Ø T mm	L mm	MSA	Jaune/Yellow
61.501		3.50	2.00	5.20	61.001	
61.502		3.50	2.00	6.20	61.002	
61.503		4.00	2.00	5.50	61.003	
61.504		4.00	2.00	5.70	61.004	
61.505		4.00	2.20	5.70	61.005	
61.506		4.00	2.20	6.00	61.006	
61.507		4.00	2.20	6.70	61.007	
61.508		4.00	2.50	6.20	61.008	
61.509		4.00	2.50	6.30	61.009	
61.510		4.00	2.50	6.60	61.010	
61.511		4.00	2.50	7.10	61.011	
61.512		4.00	2.50	7.20	61.012	
61.513		4.50	2.50	6.00	61.013	
61.514		5.00	2.60	6.50	61.014	
61.515		5.50	2.60	7.00	61.015	
61.516		6.00	2.60	7.20	61.016	

Kg 0.001

1/1



Assortiment de poussoirs à chasser étanches couleur acier, **forme antique** ; acier inoxydable.

Assortment of steel colour waterproof press-in pushers, **antique shape** ; stainless steel.

Sortiment von Stahlfarbe wasserdichte Drücker zum einpressen, **Antiker Form** ; Edelstahl.

Surtido de pulsadores a presión herméticos color acero, **forma antigua** ; acero inoxidable.

Assortimento di pulsanti a pressione impermeabili colore acciaio, **forma antica** ; acciaio inossidabile.

Sortido de botões de pressão estanques cor aço, **forma antiga** ; aço inoxidável.

Contenu - Contents - Inhalt - Contenido - Contenuto - Conteúdo : 16 modèles - models - Modelle - modelos - modelli - modelos 2x MSA61.501 /.502 /.503 /.504 /.505 /.506 /.507 /.508 /.509 /.510 /.511 /.512 /.513 /.514 /.515 /.516

MSA	Qt.	Kg
99.236	32x	0.046



Assortiment de poussoirs à chasser étanches jaunes, **forme antique** ; acier inoxydable.

Assortment of yellow waterproof press-in pushers, **antique shape** ; stainless steel.

Sortiment von gelbe wasserdichte Drücker zum einpressen, **Antiker Form** ; Edelstahl.

Surtido de pulsadores a presión herméticos amarillos, **forma antigua** ; acero inoxidable.

Assortimento di pulsanti a pressione impermeabili gialli, **forma antica** ; acciaio inossidabile.

Sortido de botões de pressão estanques amarelos, **forma antiga** ; aço inoxidável.

Contenu - Contents - Inhalt - Contenido - Contenuto - Conteúdo : 16 modèles - models - Modelle - modelos - modelli - modelos 2x MSA61.001 /.002 /.003 /.004 /.005 /.006 /.007 /.008 /.009 /.010 /.011 /.012 /.013 /.014 /.015 /.016

MSA	Qt.	Kg
99.237	32x	0.047

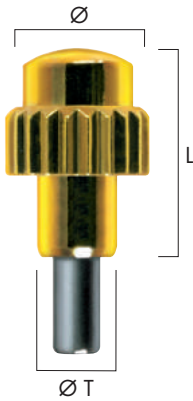

Poussoir à chasser étanche couleur acier et jaune, **forme cannelée** ; acier inoxydable.

















Steel colour and yellow waterproof press-in pusher, **fluted shape** ; stainless steel.

Stahlfarbe und gelber wasserdichter Drücker zum einpressen, **geriffelter Form** ; Edelstahl.

Pulsador a presión hermético color acero y amarillo, **forma estriada** ; acero inoxidable.

Pulsante a pressione impermeabile colore acciaio e giallo, **forma zigrinata** ; acciaio inossidabile.

Botão de pressão estanque cor aço e amarelo, **forma estriada** ; aço inoxidável.

MSA	Couleur acier/Steel colour	Ø mm	Ø T mm	L mm	MSA	Jaune/Yellow
61.552		4.50	2.40	5.20	61.052	
61.553		4.50	2.50	6.30	61.053	
61.554		4.50	2.50	6.50	61.054	
61.555		4.50	2.50	7.00	61.055	
61.556		5.00	2.50	5.70	61.056	
61.557		5.00	2.50	6.60	61.057	
61.558		5.00	2.50	7.10	61.058	
61.559		5.00	3.00	8.30	61.059	
61.551		5.50	2.30	6.70	61.051	
61.560		6.00	2.60	7.20	61.060	

Kg 0.001

1/1

61.551	61.552	61.553	61.554	61.555	61.556
ø 5.50	4.50	4.50	4.50	4.50	5.00
ø 2.30	2.40	2.50	2.50	2.50	2.50
L 6.70	5.20	6.30	6.50	7.00	5.70

ASSORTIMENT DE POUSSOIRS À CHASSER ÉTANCHES FORME CANNELÉE, ACIER INOXYDABLE.
ASSORTMENT OF WATERPROOF PRESS-IN PUSHERS FLUTED SHAPE, ST. STEEL.
SORTIMENT VON STAHLFARBE WASSERDICHTE DRÜCKER ZUM EINPRESSEN, GERIFFELTER FORM ; EDELSTAHL.
ASSORTIMENTO DI PULSANTI A PRESSIONE IMPERMEABILI FORMA ESTRIATA, ACCIAIO INOSSIDABILE.

MSA 99.239  20 pieces



Assortiment de pousoirs à chasser étanches couleur acier, **forme cannelée** ; acier inoxydable.

Assortment of steel colour waterproof press-in pushers, **fluted shape** ; stainless steel.

Sortiment von Stahlfarbe wasserdichte Drücker zum einpressen, **geriffelter Form** ; Edelstahl.

Surtido de pulsadores a presión herméticos color acero, **forma estriada** ; acero inoxidable.

Assortimento di pulsanti a pressione impermeabili colore acciaio, **forma zigrinata** ; acciaio inossidabile.

Sortido de botões de pressão estanques cor aço, **forma estriada** ; aço inoxidável.

Contenu - Contents - Inhalt - Contenido - Contenuto - Conteúdo : 10 modèles - models - Modelle - modelos - modelli - modelos 2x MSA61.551 /.552 /.553 /.554 /.555 /.556 /.557 /.558 /.559 /.560

MSA	Qt.	Kg
99.239	20x	0.033

61.051	61.052	61.053	61.054	61.055	61.056
ø 5.50	4.50	4.50	4.50	4.50	5.00
ø 2.30	2.40	2.50	2.50	2.50	2.50
L 6.70	5.20	6.30	6.50	7.00	5.70

ASSORTIMENT DE POUSSOIRS À CHASSER ÉTANCHES FORME CANNELÉE, JAUNES
ASSORTMENT OF WATERPROOF PRESS-IN PUSHERS FLUTED SHAPE, YELLOW
SORTIMENT VON GELBE WASSERDICHTE DRÜCKER ZUM EINPRESSEN, GERIFFELTER FORM ; EDELSTAHL.
ASSORTIMENTO DI PULSANTI A PRESSIONE IMPERMEABILI FORMA ESTRIATA, ACCIAIO INOSSIDABILE.

MSA 99.238  20 pieces



Assortiment de pousoirs à chasser étanches jaunes, **forme cannelée** ; acier inoxydable.

Assortment of yellow waterproof press-in pushers, **fluted shape** ; stainless steel.

Sortiment von gelbe wasserdichte Drücker zum einpressen, **geriffelter Form** ; Edelstahl.

Surtido de pulsadores a presión herméticos amarillos, **forma estriada** ; acero inoxidable.

Assortimento di pulsanti a pressione impermeabili gialli, **forma zigrinata** ; acciaio inossidabile.

Sortido de botões de pressão estanques amarelos, **forma estriada** ; aço inoxidável.

Contenu - Contents - Inhalt - Contenido - Contenuto - Conteúdo : 10 modèles - models - Modelle - modelos - modelli - modelos 2x MSA61.051 /.052 /.053 /.054 /.055 /.056 /.057 /.058 /.059 /.060

MSA	Qt.	Kg
99.238	20x	0.034

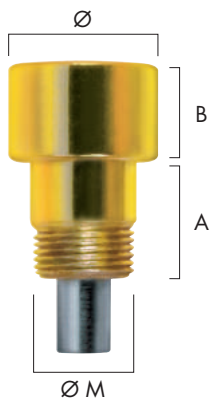

Poussoir à visser étanche couleur acier, jaune et noir, **formes cylindrique, antique et cannelée** ; acier inoxydable.

Steel colour, yellow and black waterproof screw-on pusher, **cylindrical, antique and fluted shapes** ; stainless steel.

Stahlfarbe, gelber und schwarzer wasserdichter Schraubdrücker, **zylindrische, Antik und geriffelte Formen** ; Edelstahl.

Pulsador de rosca hermético color acero, amarillo y negro, **formas cilíndrica, antigua y estriada** ; acero inoxidable.

Pulsante a vite impermeabile colore acciaio, giallo e nero, **forme cilindrica, antica e zigrinata** ; acciaio inossidabile.

Botão de rosca estanque cor aço, amarelo e preto, **formas cilíndrica, antiga e estriada** ; aço inoxidável.

MSA	Couleur acier / Steel colour	Ø x Ø M mm	A + B mm	Forme / Shape	MSA	Jaune / Yellow	MSA	Noir / Black
61.701		4.00 x 2.50	3.20 + 2.70	Cylindrique / Cylindrical	61.201		61.301	
61.703		4.00 x 2.50	3.15 + 2.80	Antique / Antique	61.203		-	-
61.704		4.00 x 2.80	4.50 + 3.20	Cylindrique / Cylindrical	61.204		-	-
61.702		4.40 x 2.50	3.00 + 2.80	Cylindrique / Cylindrical	61.202		-	-
61.705		4.50 x 2.80	2.90 + 2.70	Cylindrique / Cylindrical	-	-	-	-
61.706		5.00 x 2.80	3.00 + 2.70	Cylindrique / Cylindrical	61.206*		-	-
61.707		5.50 x 2.50	3.20 + 4.05	Cannelée / Fluted	61.207		-	-

Kg 0.001

* Jusqu'à épuisement des stocks / Will be discontinued after end of stock / Solange Vorrat / Hasta agotamiento del stock / Fino ad esaurimento dello stock / Até esgotamento do stock

1/1



61.201	61.202	61.203	61.204	61.207	61.701
ø 4.00	4.40	4.00	4.00	5.50	4.00
ø 2.50	2.50	2.50	2.80	2.50	2.50
ø 2.20	ø 2.20	ø 2.20	ø 2.20	ø 2.20	ø 2.20

HOLDFORME 4 ANTIPTI TRIMMER DE FORMAS CILINDRICAS ANTICAS Y ESTRIADAS
 WEISSFORMEN 4 ANTIPTI TRIMMER FÜR FORMEN ZYLINDRISCH ANTIK UND GERIFFELT
 PULSADORES ROSCA HERMÉTICO DE COLORES DE ACERO Y AMARILLO Y NEGRO
 PULSANTI A VITE IMPERMEABILI DI COLORE ACCIAIO, GIALLO E NERO
 BOTÕES DE ROSCA ESTANQUE DE CORES AÇO, AMARELO E PRETO

MSA 99 235 24 pieces



Assortiment de poussoirs à visser étanches couleur acier et jaunes, **formes cylindrique, antique et cannelée** ; acier inoxydable.

Assortment of steel colour and yellow waterproof screw-on pushers, **cylindrical, antique and fluted shapes** ; stainless steel.

Sortiment von Stahlfarbe und gelbe wasserdichte Schraubdrücker, **zylindrische, Antik und geriffelte Formen** ; Edelstahl.

Surtido de pulsadores de rosca herméticos color acero y amarillos, **formas cilíndrica, antigua y estriada** ; acero inoxidable.

Assortimento di pulsanti a vite impermeabili colore acciaio e gialli, **forme cilindrica, antica e zigrinata** ; acciaio inossidabile.

Sortido de botões de rosca estanques cor aço e amarelos, **formas cilíndrica, antiga e estriada** ; aço inoxidável.

Contenu - Contents - Inhalt - Contenido - Contenuto - Conteúdo :
12 modèles - models - Modelle - modelos - modelli - modelos
2x MSA61.201 / .202 / .203 / .204 / .207 / .701 / .702 / .703 / .704 / .705 / .706 / .707

MSA	Qt.	Kg
99.235	24x	0.035

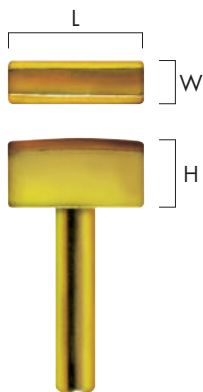

Poussoir rectangulaire couleur acier, jaune et rose.
Steel colour, yellow and pink rectangular pusher.
 Stahlfarbe, gelber und rosa rechteckiger Drücker.
Pulsador rectangular color acero, amarillo e rosado.
 Pulsante rettangolare colore acciaio, giallo e rosa.
Botão rectangular cor aço, amarelo e cor de rosa.

MSA	Couleur acier/ Steel colour	L mm	W mm	H mm	MSA	Jaune/ Yellow	MSA	Rose/ Pink
61.411		5.00	1.60	2.50	61.811		61.911	
-	-	5.00	2.00	2.00	-	-	61.912	
-	-	5.00	2.00	2.50	61.816		-	-
61.412		5.00	2.00	3.30	61.812		-	-

Kg 0.001

1/1



Assortiment de poussoirs rectangulaires couleur acier, jaunes et roses.
Assortment of steel colour, yellow and pink rectangular pushers.
 Sortiment von Stahlfarbe, gelbe und rosa rechteckiger Drücker.
Surtido de pulsadores rectangulares color acero, amarillos e rosados.
 Assortimento di pulsanti rettangolari colore acciaio, gialli e rosa.
Sortido de botões rectangulares cor aço, amarelos e cor de rosa.

MSA	Qt.	Kg
99.193	12x	0.031

Contenu - Contents - Inhalt - Contenido - Contenuto - Conteúdo :
6 modèles - models - Modelle - modelos - modelli - modelos
2x MSA61.411 /.412 /.811 /.812 /.911 /.912



MSA	Qt.	Kg
99.143	70x	0.025

Assortiment de clips pour ressorts de poussoirs.

Assortment of clips pusher springs.

Sortiment von Klipps für Drückfeder.

Surtido de clips para muelles de pulsadores.

Assortimento di clip per molle di pulsanti.

Sortido de clips para molas de botões.

Contenu - Contents - Inhalt - Contenido - Contenuto - Conteúdo :
7 modèles - models - Modelle - modelos - modelli - modelos
10x CT390.0043 /.0068 /.0069 /S81400669 /S83200219 /
S83200241 /S83200273

Ruled area with horizontal dotted lines for notes.

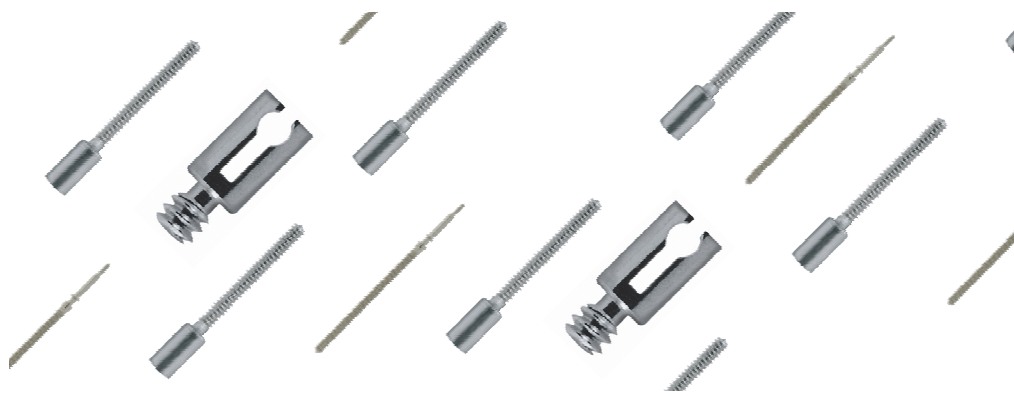

RALLONGEURS DE TIGES

08 - 2

TIGERONS

08 - 4

TIGES DE REMONTOIR

08 - 5





100 pièces / pieces / Stück / piezas / pezzi

Rallongeur de tiges ; acier inoxydable.
Stem extender ; stainless steel.
Aufzugwellen-Verlängerung ; Edelstahl.
Alargador de tijas ; acero inoxidable.
Prolunga per alberi di carica ; acciaio inossidabile.

MSA	Ø int. mm	Ø ext. mm	Kg	
56.000	0.50	0.50	0.010	
56.001	0.50	0.60	0.010	
56.002	0.50	0.70	0.010	
56.003	0.50	0.80	0.010	
56.004	0.50	0.90	0.010	
56.005	0.60	0.50	0.010	
56.006	0.60	0.60	0.010	
56.007	0.60	0.70	0.010	
56.008	0.60	0.80	0.010	
56.009	0.60	0.90	0.010	
56.010	0.70	0.50	0.010	
56.011	0.70	0.60	0.010	
56.012	0.70	0.70	0.010	
56.013	0.70	0.80	0.010	
56.014	0.70	0.90	0.010	
56.015	*	0.70	1.00	0.010
56.016		0.70	1.10	0.010
56.017	*	0.70	1.20	0.010
56.018		0.70	1.30	0.010
56.020	*	0.80	0.50	0.010
56.021		0.80	0.60	0.010
56.022		0.80	0.70	0.010
56.023		0.80	0.80	0.010
56.024		0.80	0.90	0.010

MSA	Ø int. mm	Ø ext. mm	Kg	
56.025	*	0.80	1.00	0.010
56.026	*	0.80	1.10	0.010
56.027		0.80	1.20	0.010
56.028		0.80	1.30	0.010
56.029		0.80	1.40	0.010
56.030		0.90	0.50	0.010
56.031		0.90	0.60	0.010
56.032		0.90	0.70	0.010
56.033		0.90	0.80	0.010
56.034		0.90	0.90	0.010
56.035		0.90	1.00	0.010
56.036		0.90	1.10	0.010
56.037		0.90	1.20	0.010
56.040		1.00	0.70	0.010
56.041	*	1.00	0.80	0.010
56.043		1.00	1.00	0.010
56.044	*	1.00	1.10	0.010
56.045		1.00	1.20	0.010
56.046		1.00	1.30	0.010
56.047		1.00	1.40	0.010
56.048		1.10	0.70	0.010
56.049		1.10	0.80	0.010
56.050		1.10	0.90	0.010
56.052		1.10	1.10	0.010

MSA	Ø int. mm	Ø ext. mm	Kg
56.054	1.10	1.30	0.010
56.055	1.10	1.40	0.010
56.056	1.20	0.70	0.010
56.057	1.20	0.80	0.010
56.058	1.20	0.90	0.010
56.059	1.20	1.00	0.010
56.060	1.20	1.10	0.010
56.061	1.20	1.20	0.010
56.062	1.20	1.30	0.010
56.063	1.20	1.40	0.010
56.064	1.30	0.70	0.010
56.065	1.30	0.80	0.010
56.067	1.30	1.00	0.010
56.068	1.30	1.10	0.010
56.069	1.30	1.20	0.010
56.071	1.30	1.40	0.010
56.072	1.40	0.70	0.010
56.073	1.40	0.80	0.010
56.074	1.40	0.90	0.010
56.075	1.40	1.00	0.010
56.076	1.40	1.10	0.010
56.077	1.40	1.20	0.010
56.079	1.40	1.40	0.010

* Jusqu'à épuisement des stocks / Will be discontinued after end of stock / Solange Vorrat / Hasta agotamiento del stock / Fino ad esaurimento dello stock



MSA	Qté. / Qty.	Kg
99.022	24x	0.026

Assortiment de rallongeurs de tiges ; acier inoxydable.
Assortiment of stem extenders ; stainless steel.
Sortiment von Aufzugswellen-Verlängerungen ; Edelstahl.
Surtido de alargadores de tijas ; acero inoxidable.
Assortimento di prolunghe per alberi di carica ; acciaio inossidabile.

Contenu - Contents - Inhalt - Contenido - Contenuto : 12 modèles - models - Modelle - modelos - modelli
2x MSA56.006 .012 .014 .023 .032 .033 .034 .037 .043 .052 .058 .061



MSA	Qté. / Qty.	Kg
99.021	120x	0.031

Assortiment de rallongeurs de tiges ; acier inoxydable.
Assortment of stem extenders ; stainless steel.
Sortiment von Aufzugswellen-Verlängerungen ; Edelstahl.
Surtido de alargadores de tijas ; acero inoxidable.
Assortimento di prolunghe per alberi di carica ; acciaio inossidabile.

Contenu - Contents - Inhalt - Contenido - Contenuto : 12 modèles - models - Modelle - modelos - modelli
10x MSA56.006 .012 .014 .023 .032 .033 .034 .037 .043 .052 .058 .061



MSA	Longueur / Length mm	Kg
56.500-8479	3	0.001

Tigeron femelle ; acier inoxydable.
 Female pivot-shank ; stainless steel.
 Muttertigeron ; Edelstahl.
 Tijita hembra ; acero inoxidable.
 Albero a strappo femmina ; acciaio inossidabile.



MSA	Longueur / Length mm	Ø Tar. / Tap. mm	Kg
56.500-09	12	0.90	0.001

Tigeron femelle ; acier inoxydable.
 Female pivot-shank ; stainless steel.
 Muttertigeron ; Edelstahl.
 Tijita hembra ; acero inoxidable.
 Albero a strappo femmina ; acciaio inossidabile.

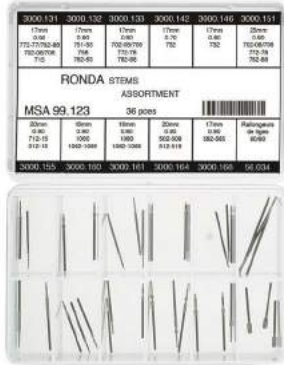

MSA	Qté. / Qty.	Kg
99.123	36x	0.026

Assortiment de tiges de remontoir Ronda.
 Assortment of Ronda winding stems.
 Sortiment von Ronda Aufzugwellen.
 Surtido tijas de remontuar Ronda.
 Assortimento di alberi di carica Ronda.

Contenu - Contents - Inhalt - Contenido - Contenuto :

12 modèles - models - Modelle - modelos - modelli

Réf./Item no.	Calibres	Dimension / Size mm
0.03x MSA56.034	Rallongeur de tige / Stem extender	Ø int. 0.90 x Ø ext. 0.90 mm
3x RL3000.131	702-706-708-715-772-777-782-788	Ø 0.90 x L 17 mm
3x RL3000.132	751-753-756-762-763	Ø 0.90 x L 17 mm
3x RL3000.133	702-706-708-772-778-782-788	Ø 0.90 x L 17 mm
3x RL3000.142	732	Ø 0.70 x L 17 mm
3x RL3000.146	732	Ø 0.80 x L 17 mm
3x RL3000.151	702-706-708-772-778-782-788	Ø 0.90 x L 25 mm
3x RL3000.155	312-315-712-715	Ø 0.90 x L 20 mm
3x RL3000.160	1060-1062-1069	Ø 0.90 x L 16 mm
3x RL3000.161	1060-1062-1069	Ø 0.90 x L 16 mm
3x RL3000.164	502-509-512-519	Ø 0.90 x L 20 mm
3x RL3000.168	582-585	Ø 0.90 x L 17 mm

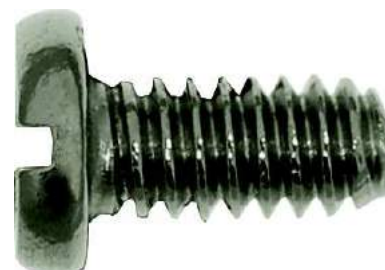
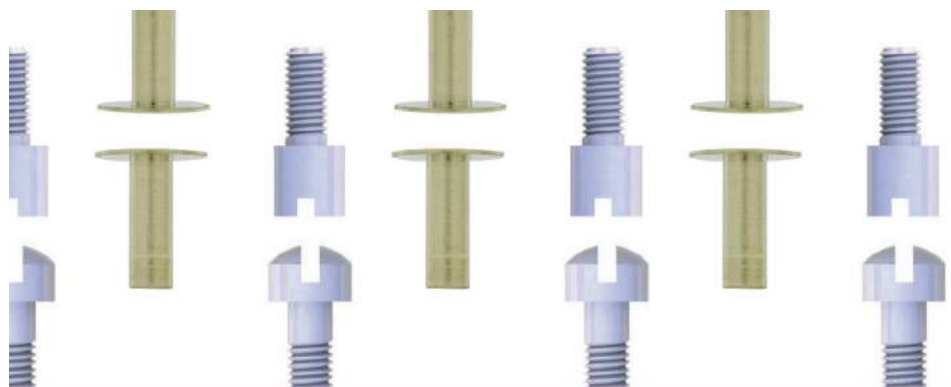

PIEDS DE CADRAN ■ DIAL FEET ■ ZIFFERBLATTFÜSSE
PIES DE ESFERA ■ PIEDINI DI QUADRANTE

09 - 2

VIS POUR FONDS DE BOÎTES ■ SCREWS FOR CASE BACKS ■ SCHRAUBEN FÜR GEHÄUSEBÖDEN
TORNILLOS PARA FONDOS DE CAJAS ■ VITI PER FONDO CASSA

09 - 3





Pied de cadran à coller, longueur 3 mm ; sachet de 10 pièces.
 Adhesive dial foot, length 3 mm ; bag of 10 pieces.
 Klebezifferblattfuss, Länge 3 mm ; Beutel mit 10 Stück.

Pie de esfera para pegar, longitud 3 mm ; bolsita de 10 piezas.
 Piedino di quadrante da incollare, lunghezza 3 mm ; bustina da 10 pezzi.

*Utiliser MSA26.534 (Loctite 496) pour coller les pieds de cadran.
 Use MSA26.534 (496 Loctite) to stick the dial feet.
 MSA26.534 (Loctite 496) benutzen, um die Zifferblattfüsse zu kleben.*

*Utilizar MSA26.534 (Loctite 496) para pegarse los pies de esfera.
 Utilizzare MSA26.534 (Loctite 496) per incollare i piedini di quadrante.*

10 pièces / pieces / Stück / piezas / pezzi

MSA	A x B x C mm	Kg
71.011-064	2.50 x 0.10 x 0.64	0.001
71.011-069	2.50 x 0.10 x 0.69	0.001

MSA	A x B x C mm	Kg
71.011-074	2.50 x 0.10 x 0.74	0.001
71.011-079	2.50 x 0.10 x 0.79	0.001

MSA	A x B x C mm	Kg
71.011-094	2.50 x 0.10 x 0.94	0.001
71.011-104	2.50 x 0.10 x 1.04	0.001



MSA	Qté. / Qty.	Kg
99.153	60x	0.025

Assortiment de pieds de cadran à coller, longueur 3 mm.
 Assortment of adhesive dial feet, length 3 mm.
 Sortiment von Klebezifferblattfüsse, Länge 3 mm.

Surtido de pies de esfera para pegar, longitud 3 mm.
 Assortimento di piedini di quadrante da incollare, lunghezza 3 mm.



**Contenu / Contents / Inhalt / Contenido / Contenuto : 6 modèles - models - Modelle - modelos - modelli
 10x MSA71.011-064 -069 -074 -079 -094 -104**

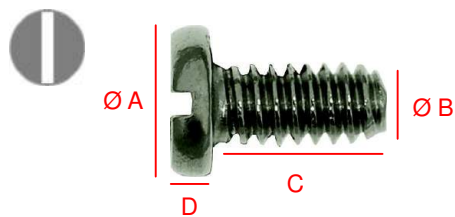

Vis pour fonds de boîtes en acier inoxydable avec tête plate ; sachet de 10 pièces.
Stainless steel screw for case backs with flat head ; bag of 10 pieces.
Edelstahl Schraube für Gehäuseböden mit flachem Kopf ; Beutel mit 10 Stück.

Tornillo para fondos de cajas en acero inoxidable con cabeza plana ; bolsita de 10 piezas.
Vite per fondo cassa in acciaio inossidabile con testa piatta ; bustina da 10 pezzi.

10 pièces / pieces / Stück / piezas / pezzi

MSA	A x B x C x D mm	Kg
71.500	1.20x1.00x1.50x0.70	0.001
71.501	1.40x1.00x1.70x0.70	0.001
71.502	1.50x1.00x1.60x0.70	0.001
71.503	1.50x1.00x2.00x0.70	0.001
71.504	1.60x1.00x2.00x0.70	0.001
71.505	1.60x1.00x2.20x0.70	0.001

MSA	A x B x C x D mm	Kg
71.506	1.80x1.00x1.50x0.70	0.001
71.507	1.80x1.00x1.80x0.70	0.001
71.508	1.80x1.00x2.50x0.70	0.001
71.509	1.80x1.00x2.70x0.70	0.001
71.510	1.80x1.40x1.50x0.70	0.001
71.511	1.80x1.40x1.50x0.70	0.001

MSA	A x B x C x D mm	Kg
71.512	2.00x1.20x2.20x0.70	0.001
71.513	2.00x1.20x2.50x0.70	0.001
71.514	2.00x1.40x2.00x0.70	0.001
71.515	2.00x1.40x2.40x0.70	0.001
71.516	2.50x1.40x2.60x0.70	0.001
71.517	2.50x1.40x3.00x0.70	0.001

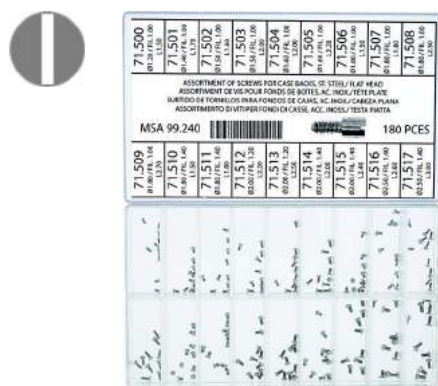

MSA	Qté. / Qty.	Kg
99.240	180x	0.042

Assortiment de vis pour fonds de boîtes avec tête plate ; acier inoxydable.
Assortment of screws for case backs with flat head ; stainless steel.
Sortiment von Schrauben für Gehäuseböden mit flachem Kopf ; Edelstahl.

Surtido de tornillos para fondos de cajas con cabeza plana ; acero inoxidable
Assortimento di viti per fondo cassa con testa piatta ; acciaio inossidabile.



Contenu / Contents / Inhalt / Contenido / Contenuto : 18 modèles - models - Modelle - modelos - modelli
10x MSA71.500 .501 .502 .503 .504 .505 .506 .507 .508 .509 .510 .511 .512 .513 .514 .515 .516 .517

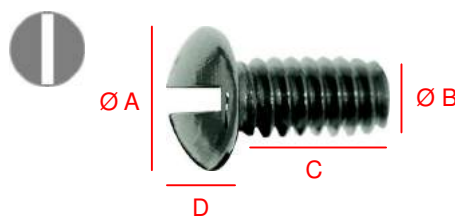

Vis pour fonds de boîtes en acier inoxydable avec tête bombée ; sachet de 10 pièces.
Stainless steel screw for case backs with rounded head ; bag of 10 pieces.
Edelstahl Schraube für Gehäuseböden mit gewölbtem Kopf ; Beutel mit 10 Stück.

Tornillo para fondos de cajas en acero inoxidable con cabeza bombeada ; bolsita de 10 piezas.
Vite per fondo cassa in acciaio inossidabile con testa bombata ; bustina da 10 pezzi.

10 pièces / pieces / Stück / piezas / pezzi

MSA	A x B x C x D mm	Kg
71.600	2.20x1.20x2.80x0.80	0.001
71.601	2.20x1.20x3.00x0.80	0.001
71.602	2.20x1.40x2.60x0.80	0.001
71.603	2.20x1.40x2.80x0.80	0.001
71.604	2.30x1.20x3.30x0.80	0.001
71.605	2.30x1.20x3.60x0.80	0.001

MSA	A x B x C x D mm	Kg
71.606	2.30x1.40x3.00x0.80	0.001
71.607	2.30x1.40x3.40x0.80	0.001
71.608	2.50x1.20x2.80x0.80	0.001
71.609	2.50x1.20x3.20x0.80	0.001
71.610	2.50x1.40x2.60x0.80	0.001
71.611	2.50x1.40x3.00x0.80	0.001

MSA	A x B x C x D mm	Kg
71.612	2.70x1.20x3.20x0.80	0.001
71.613	2.70x1.20x3.60x0.80	0.001
71.614	2.70x1.40x3.00x0.80	0.001
71.615	2.70x1.40x3.30x0.80	0.001
71.616	2.90x1.20x3.60x0.80	0.001
71.617	2.90x1.40x3.30x0.80	0.001



MSA	Qté. / Qty.	Kg
99.241	180x	0.042

Assortiment de vis pour fonds de boîtes avec tête bombée ; acier inoxydable.
 Assortment of screws for case backs with rounded head ; stainless steel.
 Sortiment von Schrauben für Gehäuseböden mit gewölbtem Kopf ; Edelstahl.

Surtido de tornillos para fondos de cajas con cabeza bombeada ; acero inoxidable.
 Assortimento di viti per fondo cassa con testa bombata ; acciaio inossidabile.



Contenu / Contents / Inhalt / Contenido / Contenuto : 18 modèles - models - Modelle - modelos - modelli
10x MSA71.600 .601 .602 .603 .604 .605 .606 .607 .608 .609 .610 .611 .612 .613 .614 .615 .616 .617

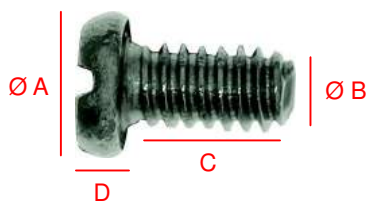

Vis pour fonds de boîtes en acier inoxydable avec tête cruciforme ; sachet de 10 pièces.
 Stainless steel screw for case backs with Phillips head ; bag of 10 pieces.
 Edelstahl Schraube für Gehäuseböden mit Kreuzschlitzkopf ; Beutel mit 10 Stück.

Tornillo para fondos de cajas en acero inoxidable con cabeza cruciforme ; bolsita de 10 piezas.
 Vite per fondo cassa in acciaio inossidabile con testa cruciforme ; bustina da 10 pezzi.

10 pièces / pieces / Stück / piezas / pezzi

MSA	A x B x C x D mm	Kg
71.700	1.40x1.00x1.50x0.70	0.001
71.701	1.50x1.20x1.60x0.70	0.001
71.702	1.50x1.20x2.00x0.70	0.001
71.703	1.60x1.00x2.00x0.70	0.001
71.704	1.60x1.00x2.20x0.70	0.001
71.705	1.80x1.00x2.50x0.70	0.001

MSA	A x B x C x D mm	Kg
71.706	1.80x1.00x2.70x0.70	0.001
71.707	2.00x1.20x2.40x0.70	0.001
71.708	2.00x1.40x1.80x0.70	0.001
71.709	2.00x1.40x2.20x0.70	0.001
71.710	2.20x1.20x2.80x0.70	0.001
71.711	2.20x1.40x3.00x0.70	0.001

MSA	A x B x C x D mm	Kg
71.712	2.20x1.40x3.30x0.70	0.001
71.713	2.30x1.20x3.60x0.70	0.001
71.714	2.50x1.20x3.20x0.70	0.001
71.715	2.50x1.30x2.80x0.70	0.001
71.716	2.50x1.40x2.60x0.70	0.001



MSA	Qté. / Qty.	Kg
99.242	170x	0.039

Assortiment de vis pour fonds de boîtes avec tête cruciforme ; acier inoxydable.
 Assortment of screws for case backs with Phillips head ; stainless steel.
 Sortiment von Schrauben für Gehäuseböden mit Kreuzschlitzkopf ; Edelstahl.

Surtido de tornillos para fondos de cajas con cabeza cruciforme ; acero inoxidable.
 Assortimento di viti per fondo cassa con testa cruciforme ; acciaio inossidabile.



Contenu / Contents / Inhalt / Contenido / Contenuto : 17 modèles - models - Modelle - modelos - modelli
10x MSA71.700 .701 .702 .703 .704 .705 .706 .707 .708 .709 .710 .711 .712 .713 .714 .715 .716



FERMOIRS CLASPS SCHLIESSEN CIERRES CHIUSURE FECHOS

Fermoirs pour bracelets
Clasps for straps
Schliessen für Armbänder
Cierres para correas
Chiusure per cinturini
Fechos para pulseiras



2



Fermeoir déployant ; acier inoxydable.
 Folding clasp ; stainless steel.
 Faltschliesse ; Edelstahl.
 Cierre desplegable ; acero inoxidable.
 Chiusura pieghevole ; acciaio inossidabile.
 Fecho desdobrável ; aço inoxidável.

MSA	1/1	A mm	B mm	C mm	Kg
51.005		35.50	3.50	8	0.004
51.007		35.50	4	7	0.004
51.001		36.00	4.50	9	0.005
51.003		38.00	7	10	0.005
51.004		40.50	4	10	0.006
51.002		40.50	7	10	0.005
51.000		41.00	6	10	0.007



MSA	Qt.	Kg
99.138	8x	0.065

Assortiment de 8 fermeoirs déployants ; acier inoxydable.
 Assortment of 8 folding clasps ; stainless steel.
 Sortiment von 8 Faltschliessen ; Edelstahl.
 Surtido de 8 cierres desplegadas ; acero inoxidable.
 Assortimento di 8 chiusure pieghevoli ; acciaio inossidabile.
 Sortido de 8 fechos desdobráveis ; aço inoxidável.

Contenu - Contents - Inhalt - Contenido - Contenuto - Conteúdo :
6 modèles - models - Modelle - modelos - modelli - modelos
1x MSA51.002 /.003 /.004 /.005
2x MSA51.000 /.001

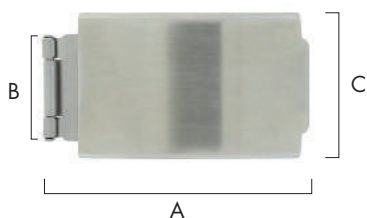

Fermeoir déployant ; acier inoxydable.

Folding clasp ; stainless steel.

Faltschliesse ; Edelstahl.

Cierre desplegable ; acero inoxidable.

Chiusura pieghevole ; acciaio inossidabile.

Fecho desdobrável ; aço inoxidável.

MSA	A mm	B mm	C mm	Bracelets/Straps mm	Kg
51.025-10	38.00	9.00	10.00	10	0.005
51.025-12	38.50	10.00	12.00	12	0.005
51.025-14	37.50	12.00	14.00	14	0.005
51.025-16	39.00	13.50	16.00	16	0.005
51.025-22B	40.00	22.00	22.00	22	0.008



Fermeoir déployant ; acier inoxydable.

Folding clasp ; stainless steel.

Faltschliesse ; Edelstahl.

Cierre desplegable ; acero inoxidable.

Chiusura pieghevole ; acciaio inossidabile.

Fecho desdobrável ; aço inoxidável.

MSA	A mm	B mm	C mm	Bracelets/Straps mm	Kg
51.025-16A	38.50	14.50	16.00	16	0.005
51.025-18A	38.50	14.50	18.00	18	0.005
51.025-18	38.50	15.50	18.00	18	0.005
51.025-20	39.00	14.50	20.00	20	0.005
51.025-20A	39.00	17.50	20.00	20	0.006
51.025-22	38.00	16.00	22.00	22	0.006

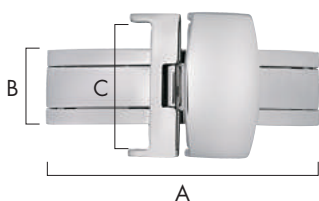

Fermeoir déployant ; acier inoxydable.

Folding clasp ; stainless steel.

Faltschliesse ; Edelstahl.

Cierre desplegable ; acero inoxidable.

Chiusura pieghevole ; acciaio inossidabile.

Fecho dobrável ; aço inoxidável.

MSA	A mm	B mm	C mm	Bracelets/Straps mm	Kg
51.008-10	35.50	8.00	10.00	10	0.007
51.008-12	36.00	8.00	12.00	12	0.008
51.008-14	36.00	8.00	14.00	14	0.010
51.008-16	40.00	11.00	16.00	16	0.012
51.008-18	40.00	11.00	18.00	18	0.012
51.008-20	40.00	11.00	20.00	20	0.012
51.008-22	40.00	11.00	22.00	22	0.012
51.008-24	40.00	11.00	24.00	24	0.012

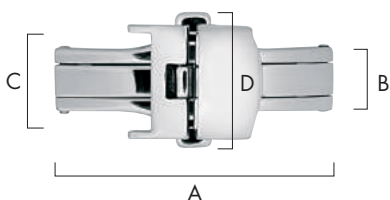

Fermeoir déployant avec boutons à pression ; acier inoxydable.

Folding clasp with push buttons ; stainless steel.

Faltschliesse mit Druckknöpfen ; Edelstahl.

Cierre desplegable con botones a presión ; acero inoxidable.

Chiusura pieghevole con bottoni a pressione ; acciaio inossidabile.

Fecho dobrável com botões de pressão ; aço inoxidável.

MSA	A mm	B mm	C mm	D mm	Bracelets/Straps mm	Kg
51.010-B	36	8	12.00	17.00	12	0.011
51.010-14	39	11	14.00	18.00	14	0.012
51.010-16	39	11	16.00	22.00	16	0.013
51.010-18	39	11	18.00	24.00	18	0.014
51.010-20	39	11	20.00	26.00	20	0.014
51.010-22	39	11	22.00	27.00	22	0.015
51.010-24	39	11	24.00	28.00	24	0.015

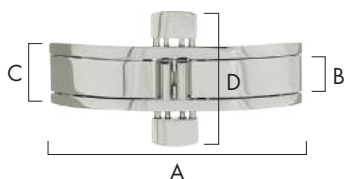

Fermeoir déployant avec boutons à pression ; acier inoxydable.

Folding clasp with push buttons ; stainless steel.

Faltschliesse mit Druckknöpfen ; Edelstahl.

Cierre desplegable con botones a presión ; acero inoxidable.

Chiusura pieghevole con bottoni a pressione ; acciaio inossidabile.

Fecho desdobrável com botões de pressão ; aço inoxidável.

MSA	A mm	B mm	C mm	D mm	Kg
51.017	36.00	4.00	8.00	18.00	0.005
51.020	40.00	6.00	10.00	22.00	0.007

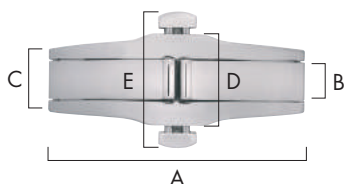

Fermeoir déployant avec boutons à pression ; acier inoxydable.

Folding clasp with push buttons ; stainless steel.

Faltschliesse mit Druckknöpfen ; Edelstahl.

Cierre desplegable con botones a presión ; acero inoxidable.

Chiusura pieghevole con bottoni a pressione ; acciaio inossidabile.

Fecho desdobrável com botões de pressão ; aço inoxidável.

MSA	A mm	B mm	C mm	D mm	E mm	Kg
51.018	35.50	4.50	8.00	11.00	18.00	0.006
51.009-15	36.00	4.00	8.00	10.00	16.00	0.006
51.019	37.00	4.50	8.00	10.00	16.00	0.006
51.021	40.00	6.00	11.00	14.00	21.00	0.010
51.009-20	40.00	7.00	11.00	14.00	21.00	0.009
51.022	40.00	7.00	11.00	16.00	23.00	0.009

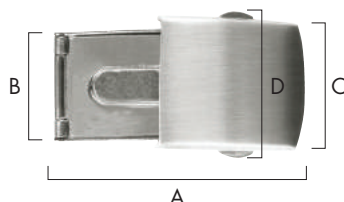

Fermeoir déployant avec boutons à pression ; acier inoxydable.

Folding clasp with push buttons ; stainless steel.

Faltschliesse mit Druckknöpfen ; Edelstahl.

Cierre desplegable con botones a presión ; acero inoxidable.

Chiusura pieghevole con bottoni a pressione ; acciaio inossidabile.

Fecho desdobrável com botões de pressão ; aço inoxidável.

MSA	A mm	B mm	C mm	D mm	Bracelets/Straps mm	Kg
51.023-12	34.00	10.00	12.00	17.00	12	0.005
51.023-14	42.00	12.00	14.00	18.00	14	0.005
51.023-16	42.00	14.00	16.00	20.00	16	0.006
51.023-18	41.50	12.00	18.00	22.00	18	0.006
51.023-20	42.50	14.00	20.00	25.00	20	0.008
51.023-22	42.00	20.00	22.00	26.00	22	0.008

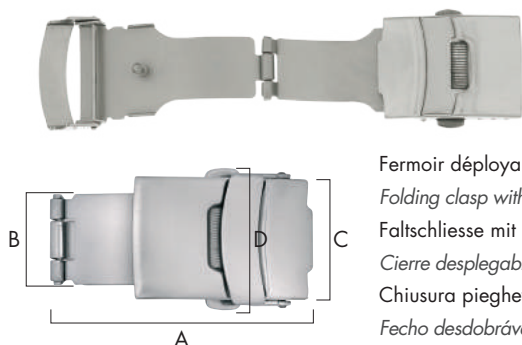

Fermeoir déployant avec boutons à pression ; acier inoxydable.

Folding clasp with push buttons ; stainless steel.

Faltschliesse mit Druckknöpfen ; Edelstahl.

Cierre desplegable con botones a presión ; acero inoxidable.

Chiusura pieghevole con bottoni a pressione ; acciaio inossidabile.

Fecho desdobrável com botões de pressão ; aço inoxidável.

MSA	A mm	B mm	C mm	D mm	Bracelets/Straps mm	Kg
51.011-12	40.00	9.00	12.00	17.00	12	0.011
51.011-14	40.00	11.00	14.00	19.00	14	0.012
51.011-16	40.00	13.00	16.00	21.00	16	0.013
51.011-18	40.00	13.00	18.00	23.00	18	0.015
51.011-20	40.00	13.00	20.00	25.00	20	0.017
51.011-22	40.00	17.00	22.00	27.00	22	0.019
51.011-24	44.00	17.00	24.00	29.00	24	0.020

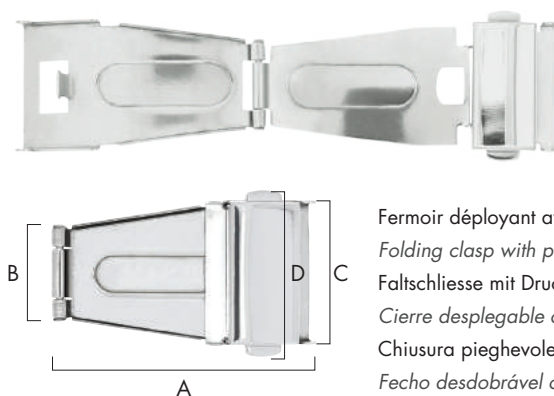

Fermeoir déployant avec boutons à pression ; acier inoxydable.

Folding clasp with push buttons ; stainless steel.

Faltschliesse mit Druckknöpfen ; Edelstahl.

Cierre desplegable con botones a presión ; acero inoxidable.

Chiusura pieghevole con bottoni a pressione ; acciaio inossidabile.

Fecho desdobrável com botões de pressão ; aço inoxidável.

MSA	A mm	B mm	C mm	D mm	Bracelets/Straps mm	Kg
51.012-10	35.00	9.50	10.00	14.00	10	0.005
51.012-12	30.00	8.00	12.00	16.00	12	0.005
51.012-14	35.00	11.00	14.00	18.00	14	0.006
51.012-15	35.00	11.00	15.00	18.00	15	0.006
51.012-16	36.5	12.00	16.00	19.00	16	0.006
51.012-17	32.00	11.00	17.00	21.00	17	0.006
51.012-18	37.00	12.00	18.00	22.00	18	0.007
51.012-19	37.00	12.00	19.00	22.00	19	0.007
51.012-20	37.50	14.00	20.00	23.00	20	0.007
51.012-22	36.50	14.00	22.00	25.00	22	0.009
51.012-24	36.50	16.00	24.00	27.00	24	0.009



Fermeoir déployant ; acier inoxydable.

Folding clasp ; stainless steel.

Faltschliesse ; Edelstahl.

Cierre desplegable ; acero inoxidable.

Chiusura pieghevole ; acciaio inossidabile.

Fecho desdobrável ; aço inoxidável.



MSA	A mm	B mm	C mm	Kg
51.006-B	33.00	4.00	9.00	0.004
51.006-10	36.00	6.00	14.00	0.006



MSA	Bracelets/Straps mm	Kg
51.015-03	3	0.001
51.015-04	4	0.001
51.015-05	5	0.002
51.015-06	6	0.002
51.015-07	7	0.002
51.015-08	8	0.002
51.015-09	9	0.002
51.015-10	10	0.003

MSA	Bracelets/Straps mm	Kg
51.015-11	11	0.003
51.015-12	12	0.003
51.015-13	13	0.003
51.015-14	14	0.003
51.015-15	15	0.004
51.015-16	16	0.004
51.015-17	17	0.004

Fermeur simple couleur acier ; acier.
Steel colour simple clasp ; steel.
 Stahlfarbe einfacher Schliesse ; Stahl.
Cierre simple color acero ; acero.
 Chiusura semplice colore acciaio ;
 acciaio.
Fecho simples cor aço ; aço.

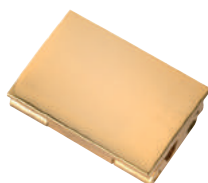

MSA	Bracelets/Straps mm	Kg
51.016-03	3	0.001
51.016-04	4	0.001
51.016-05	5	0.001
51.016-06	6	0.002
51.016-07	7	0.002
51.016-08	8	0.002
51.016-09	9	0.002
51.016-10	10	0.002

MSA	Bracelets/Straps mm	Kg
51.016-11	11	0.003
51.016-12	12	0.003
51.016-13	13	0.003
51.016-14	14	0.003
51.016-15	15	0.003
51.016-16	16	0.004
51.016-17	17	0.004

Fermeur simple jaune ; acier.
Yellow simple clasp ; steel.
 Gelber einfacher Schliesse ; Stahl.
Cierre simple amarillo ; acero.
 Chiusura semplice gialla ; acciaio.
Fecho simples amarelo ; aço.



MSA	Bracelets/Straps mm	Kg
51.013-03*	3	0.001
51.013-04*	4	0.001
51.013-05*	5	0.002
51.013-06*	6	0.002
51.013-07*	7	0.002
51.013-08*	8	0.002

MSA	Bracelets/Straps mm	Kg
51.013-10*	10	0.003
51.013-11*	11	0.003
51.013-12*	12	0.003
51.013-13*	13	0.003
51.013-14*	14	0.003
51.013-15*	15	0.004

Fermeur simple couleur acier ; acier.
Steel colour simple clasp ; steel.
Stahlfarbe einfacher Schliesse ; Stahl.
Cierre simple color acero ; acero.
Chiusura semplice colore acciaio ;
acciaio.
Fecho simples cor aço ; aço.

* *Jusqu'à épuisement des stocks / Will be discontinued after end of stock / Solange Vorrat /
Hasta agotamiento del stock / Fino ad esaurimento dello stock / Até esgotamento do stock*



MSA	Bracelets/Straps mm	Kg
51.014-04*	4	0.001
51.014-05*	5	0.001
51.014-06*	6	0.002
51.014-07*	7	0.002
51.014-08*	8	0.002
51.014-10*	10	0.002

MSA	Bracelets/Straps mm	Kg
51.014-11*	11	0.003
51.014-12*	12	0.003
51.014-13*	13	0.003
51.014-14*	14	0.003
51.014-15*	15	0.003

Fermeur simple jaune ; acier.
Yellow simple clasp ; steel.
Gelber einfacher Schliesse ; Stahl.
Cierre simple amarillo ; acero.
Chiusura semplice gialla ; acciaio.
Fecho simples amarelo ; aço.

* *Jusqu'à épuisement des stocks / Will be discontinued after end of stock / Solange Vorrat /
Hasta agotamiento del stock / Fino ad esaurimento dello stock / Até esgotamento do stock*

A series of horizontal dotted lines for writing, spanning most of the page width.

Verres minéraux
Mineral crystals
Mineralgläsern
Cristales minerales
Vetri minerali
Vidros minerais

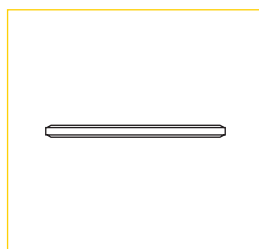

3

Verres saphir
Sapphire crystals
Saphirgläsern
Cristales zafiro
Vetri zaffiro
Vidros safira

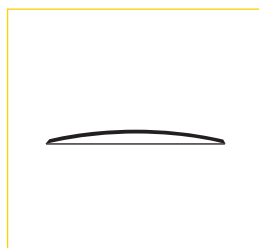

9

Plaques minérales
Mineral sheets
Mineralplatten
Placas minerales
Lastrine minerali
Placas minerais

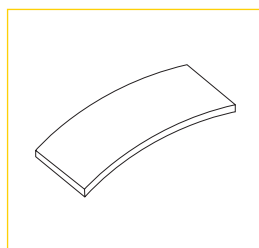

10

12

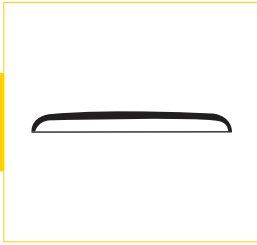

Verres plexiglas
Plexiglas crystals
Gläsern aus Plexiglas
Cristales plexiglás
Vetri plexiglas
Vidros plexiglas

14

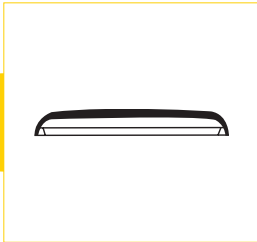

Verres ronds avec bague de tension
Round crystals with tension ring
Runde Gläsern mit Spannungsring
Cristales redondos con aro de tensión
Vetri rotondi con ghiera di tensione
Vidros redondos com aro de tensão

15

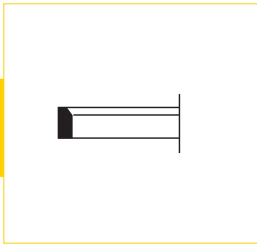

Joints pour verres
Gaskets for crystals
Dichtungen für Gläsern
Juntas para cristales
Guarnizioni per vetri
Juntas para vidros

17



Verres divers
Miscellaneous crystals
Unterschiedliche Gläsern
Cristales diversos
Vetri vari
Vidros diversos

Verre minéral plat trempé ; épaisseur entre 0.70 et 0.80 mm.
 Tempered flat mineral crystal ; thickness between 0.70 and 0.80 mm.
 Gehärtetes flaches Mineralglas ; Dicke zwischen 0.70 und 0.80 mm.
 Cristal mineral plano templado ; espesor entre 0.70 y 0.80 mm.
 Vetro minerale piatto temperato ; spessore tra 0.70 e 0.80 mm.
 Vidro mineral plano temperado ; espessura entre 0.70 e 0.80 mm.



Réf./Item no.	Ø mm
VLX.MUM120	12.00
...	...
VLX.MUM340	34.00

Incréments 0.10 mm du Ø 12.00 au Ø 34.00 mm (préciser le diamètre lors de la commande).
Increment 0.10 mm from Ø 12.00 to Ø 34.00 mm (specify the diameter when ordering).
Inkrementieren 0.10 mm von Ø 12.00 bis Ø 34.00 mm (bei der Bestellung, den Durchmesser angeben).
Incrementar 0.10 mm del Ø 12.00 al Ø 34.00 mm (precisar el diámetro en el pedido).
Incremento 0.10 mm dal Ø 12.00 al Ø 34.00 mm (specificare il diametro al momento dell'ordine).
Incrementar 0.10 mm do Ø 12.00 ao Ø 34.00 mm (precisar o diâmetro na encomenda).

Verre minéral plat trempé ; épaisseur entre 1.00 et 1.10 mm.
 Tempered flat mineral crystal ; thickness between 1.00 and 1.10 mm.
 Gehärtetes flaches Mineralglas ; Dicke zwischen 1.00 und 1.10 mm.
 Cristal mineral plano templado ; espesor entre 1.00 y 1.10 mm.
 Vetro minerale piatto temperato ; spessore tra 1.00 e 1.10 mm.
 Vidro mineral plano temperado ; espessura entre 1.00 e 1.10 mm.



Réf./Item no.	Ø mm
VLX.MMS130	13.00
...	...
VLX.MMS460	46.00

Incréments 0.10 mm du Ø 13.00 au Ø 46.00 mm (préciser le diamètre lors de la commande).
Increment 0.10 mm from Ø 13.00 to Ø 46.00 mm (specify the diameter when ordering).
Inkrementieren 0.10 mm von Ø 13.00 bis Ø 46.00 mm (bei der Bestellung, den Durchmesser angeben).
Incrementar 0.10 mm del Ø 13.00 al Ø 46.00 mm (precisar el diámetro en el pedido).
Incremento 0.10 mm dal Ø 13.00 al Ø 46.00 mm (specificare il diametro al momento dell'ordine).
Incrementar 0.10 mm do Ø 13.00 ao Ø 46.00 mm (precisar o diâmetro na encomenda).



Réf./Item no.	Ø mm
VLX.MMS/J1140	14.00
...	...
VLX.MMS/J1340	34.00
VLX.MMS/J1345	34.50
VLX.MMS/J1350	35.00
VLX.MMS/J1355	35.50
VLX.MMS/J1360	36.00
VLX.MMS/J1365	36.50
VLX.MMS/J1370	37.00
VLX.MMS/J1375	37.50
VLX.MMS/J1380	38.00
VLX.MMS/J1385	38.50
VLX.MMS/J1390	39.00
VLX.MMS/J1395	39.50
VLX.MMS/J1400	40.00

Verre minéral plat trempé, avec joint "I" ; épaisseur entre 1.00 et 1.10 mm.
 Tempered flat mineral crystal, with "I" gasket ; thickness between 1.00 and 1.10 mm.
 Gehärtetes flaches Mineralglas, mit "I" Dichtung ; Dicke zwischen 1.00 und 1.10 mm.
 Cristal mineral plano templado, con junta "I" ; espesor entre 1.00 y 1.10 mm.
 Vetro minerale piatto temperato, con guarnizione "I" ; spessore tra 1.00 e 1.10 mm.
 Vidro mineral plano temperado, com junta "I" ; espessura entre 1.00 e 1.10 mm.

Incréments 0.10 mm du Ø 14.00 au Ø 34.00 mm (préciser le diamètre lors de la commande).
Increment 0.10 mm from Ø 14.00 to Ø 34.00 mm (specify the diameter when ordering).
Inkrementieren 0.10 mm von Ø 14.00 bis Ø 34.00 mm (bei der Bestellung, den Durchmesser angeben).
Incrementar 0.10 mm del Ø 14.00 al Ø 34.00 mm (precisar el diámetro en el pedido).
Incremento 0.10 mm dal Ø 14.00 al Ø 34.00 mm (specificare il diametro al momento dell'ordine).
Incrementar 0.10 mm do Ø 14.00 ao Ø 34.00 mm (precisar o diâmetro na encomenda).



Verre minéral plat trempé ; épaisseur 1.50 mm.
 Tempered flat mineral crystal ; thickness 1.50 mm.
 Gehärtetes flaches Mineralglas ; Dicke 1.50 mm.
 Cristal mineral plano templado ; espesor 1.50 mm.
 Vetro minerale piatto temperato ; spessore 1.50 mm.
 Vidro mineral plano temperado ; espessura 1.50 mm.

Incrémenter 0.10 mm du Ø 18.00 au Ø 37.00 mm (préciser le diamètre lors de la commande).
Increment 0.10 mm from Ø 18.00 to Ø 37.00 mm (specify the diameter when ordering).
Inkrementieren 0.10 mm von Ø 18.00 bis Ø 37.00 mm (bei der Bestellung, den Durchmesser angeben).
Incrementar 0.10 mm del Ø 18.00 al Ø 37.00 mm (precisar el diámetro en el pedido).
Incremento 0.10 mm dal Ø 18.00 al Ø 37.00 mm (specificare il diametro al momento dell'ordine).
Incrementar 0.10 mm do Ø 18.00 ao Ø 37.00 mm (precisar o diâmetro na encomenda).

Réf./Item no.	Ø mm	Réf./Item no.	Ø mm	Réf./Item no.	Ø mm
VLX.MME180	18.00	VLX.MME388	38.80	VLX.MME420	42.00
...	...	VLX.MME390	39.00	VLX.MME425	42.50
VLX.MME370	37.00	VLX.MME393	39.30	VLX.MME430	43.00
VLX.MME373	37.30	VLX.MME395	39.50	VLX.MME435	43.50
VLX.MME375	37.50	VLX.MME398	39.80	VLX.MME440	44.00
VLX.MME378	37.80	VLX.MME400	40.00	VLX.MME445	44.50
VLX.MME380	38.00	VLX.MME405	40.50	VLX.MME450	45.00
VLX.MME383	38.30	VLX.MME410	41.00		
VLX.MME385	38.50	VLX.MME415	41.50		



Verre minéral plat trempé ; épaisseur 2.00 mm.
 Tempered flat mineral crystal ; thickness 2.00 mm.
 Gehärtetes flaches Mineralglas ; Dicke 2.00 mm.
 Cristal mineral plano templado ; espesor 2.00 mm.
 Vetro minerale piatto temperato ; spessore 2.00 mm.
 Vidro mineral plano temperado ; espessura 2.00 mm.

Incrémenter 0.10 mm du Ø 16.50 au Ø 39.00 mm (préciser le diamètre lors de la commande).
Increment 0.10 mm from Ø 16.50 to Ø 39.00 mm (specify the diameter when ordering).
Inkrementieren 0.10 mm von Ø 16.50 bis Ø 39.00 mm (bei der Bestellung, den Durchmesser angeben).
Incrementar 0.10 mm del Ø 16.50 al Ø 39.00 mm (precisar el diámetro en el pedido).
Incremento 0.10 mm dal Ø 16.50 al Ø 39.00 mm (specificare il diametro al momento dell'ordine).
Incrementar 0.10 mm do Ø 16.50 ao Ø 39.00 mm (precisar o diâmetro na encomenda).

Réf./Item no.	Ø mm	Réf./Item no.	Ø mm	Réf./Item no.	Ø mm
VLX.MNP155	15.50	VLX.MNP398	39.80	VLX.MNP430	43.00
VLX.MNP160	16.00	VLX.MNP400	40.00	VLX.MNP435	43.50
VLX.MNP165	16.50	VLX.MNP405	40.50	VLX.MNP440	44.00
...	...	VLX.MNP410	41.00	VLX.MNP445	44.50
VLX.MNP390	39.00	VLX.MNP415	41.50	VLX.MNP450	45.00
VLX.MNP393	39.30	VLX.MNP420	42.00		
VLX.MNP395	39.50	VLX.MNP425	42.50		



Verre minéral plat trempé, avec joint plat "L" ; épaisseur du verre 2.00 mm.
 Tempered flat mineral crystal, with "L" flat gasket ; crystal thickness 2.00 mm.
 Gehärtetes flaches Mineralglas, mit "L" Flachdichtung ; Glasdicke 2.00 mm.
 Cristal mineral plano templado, con junta plana "L" ; espesor del cristal 2.00 mm.
 Vetro minerale piatto temperato, con guarnizione piatta "L" ; spessore del vetro 2.00 mm.
 Vidro mineral plano temperado, com junta plana "L" ; espessura do vidro 2.00 mm.

Réf./Item no.	Ø mm
VLX.MNR/PJ176	17.60
...	...
VLX.MNR/PJ371	37.10

Incrémenter 0.10 mm du Ø 17.60 au Ø 37.10 mm (préciser le diamètre lors de la commande).
Increment 0.10 mm from Ø 17.60 to Ø 37.10 mm (specify the diameter when ordering).
Inkrementieren 0.10 mm von Ø 17.60 bis Ø 37.10 mm (bei der Bestellung, den Durchmesser angeben).
Incrementar 0.10 mm del Ø 17.60 al Ø 37.10 mm (precisar el diámetro en el pedido).
Incremento 0.10 mm dal Ø 17.60 al Ø 37.10 mm (specificare il diametro al momento dell'ordine).
Incrementar 0.10 mm do Ø 17.60 ao Ø 37.10 mm (precisar o diâmetro na encomenda).



Verre minéral plat trempé ; épaisseur 2.50 mm.
 Tempered flat mineral crystal ; thickness 2.50 mm.
 Gehärtetes flaches Mineralglas ; Dicke 2.50 mm.
 Cristal mineral plano templado ; espesor 2.50 mm.
 Vetro minerale piatto temperato ; spessore 2.50 mm.
 Vidro mineral plano temperado ; espessura 2.50 mm.

Incrémenter 0.10 mm du Ø 17.50 au Ø 34.50 mm (préciser le diamètre lors de la commande).
Increment 0.10 mm from Ø 17.50 to Ø 34.50 mm (specify the diameter when ordering).
Inkrementieren 0.10 mm von Ø 17.50 bis Ø 34.50 mm (bei der Bestellung, den Durchmesser angeben).
Incrementar 0.10 mm del Ø 17.50 al Ø 34.50 mm (precisar el diámetro en el pedido).
Incremento 0.10 mm dal Ø 17.50 al Ø 34.50 mm (specificare il diametro al momento dell'ordine).
Incrementar 0.10 mm do Ø 17.50 ao Ø 34.50 mm (precisar o diâmetro na encomenda).

Réf./Item no.	Ø mm
VLX.MSE175	17.50
...	...
VLX.MSE345	34.50
VLX.MSE350	35.00
VLX.MSE355	35.50
VLX.MSE360	36.00
VLX.MSE365	36.50
VLX.MSE370	37.00

Réf./Item no.	Ø mm
VLX.MSE375	37.50
VLX.MSE380	38.00
VLX.MSE385	38.50
VLX.MSE390	39.00
VLX.MSE395	39.50
VLX.MSE400	40.00
VLX.MSE405	40.50
VLX.MSE410	41.00

Réf./Item no.	Ø mm
VLX.MSE415	41.50
VLX.MSE420	42.00
VLX.MSE425	42.50
VLX.MSE430	43.00
VLX.MSE435	43.50
VLX.MSE440	44.00
VLX.MSE445	44.50
VLX.MSE450	45.00

Verre minéral plat trempé ; épaisseur 3.00 mm.
 Tempered flat mineral crystal ; thickness 3.00 mm.
 Gehärtetes flaches Mineralglas ; Dicke 3.00 mm.
 Cristal mineral plano templado ; espesor 3.00 mm.
 Vetro minerale piatto temperato ; spessore 3.00 mm.
 Vidro mineral plano temperado ; espessura 3.00 mm.

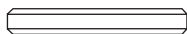

Incréments 0.10 mm du Ø 25.00 au Ø 34.00 mm (préciser le diamètre lors de la commande).
Increment 0.10 mm from Ø 25.00 to Ø 34.00 mm (specify the diameter when ordering).
Inkrementieren 0.10 mm von Ø 25.00 bis Ø 34.00 mm (bei der Bestellung, den Durchmesser angeben).
Incrementar 0.10 mm del Ø 25.00 al Ø 34.00 mm (precisar el diámetro en el pedido).
Incremento 0.10 mm dal Ø 25.00 al Ø 34.00 mm (specificare il diametro al momento dell'ordine).
Incrementar 0.10 mm do Ø 25.00 ao Ø 34.00 mm (precisar o diâmetro na encomenda).

Réf./Item no.	Ø mm
VLX.MTE250	25.00
...	...
VLX.MTE340	34.00
VLX.MTE345	34.50
VLX.MTE350	35.00
VLX.MTE355	35.50
VLX.MTE360	36.00
VLX.MTE365	36.50
VLX.MTE370	37.00

Réf./Item no.	Ø mm
VLX.MTE375	37.50
VLX.MTE380	38.00
VLX.MTE385	38.50
VLX.MTE390	39.00
VLX.MTE395	39.50
VLX.MTE400	40.00
VLX.MTE405	40.50
VLX.MTE410	41.00
VLX.MTE415	41.50

Réf./Item no.	Ø mm
VLX.MTE420	42.00
VLX.MTE425	42.50
VLX.MTE430	43.00
VLX.MTE435	43.50
VLX.MTE440	44.00
VLX.MTE445	44.50
VLX.MTE450	45.00



Verre minéral bombé trempé ; épaisseur entre 0.80 et 0.90 mm.
 Tempered domed mineral crystal ; thickness between 0.80 and 0.90 mm.
 Gehärtetes gewölbtes Mineralglas ; Dicke zwischen 0.80 und 0.90 mm.
 Cristal mineral bombeado templado ; espesor entre 0.80 y 0.90 mm.
 Vetro minerale bombato temperato ; spessore tra 0.80 e 0.90 mm.
 Vidro mineral encurvado temperado ; espessura entre 0.80 e 0.90 mm.

Réf./Item no.	Ø mm
VLX.MMB140	14.00
...	...
VLX.MMB340	34.00

Incréments 0.10 mm du Ø 14.00 au Ø 34.00 mm (préciser le diamètre lors de la commande).
Increment 0.10 mm from Ø 14.00 to Ø 34.00 mm (specify the diameter when ordering).
Inkrementieren 0.10 mm von Ø 14.00 bis Ø 34.00 mm (bei der Bestellung, den Durchmesser angeben).
Incrementar 0.10 mm del Ø 14.00 al Ø 34.00 mm (precisar el diámetro en el pedido).
Incremento 0.10 mm dal Ø 14.00 al Ø 34.00 mm (specificare il diametro al momento dell'ordine).
Incrementar 0.10 mm do Ø 14.00 ao Ø 34.00 mm (precisar o diâmetro na encomenda).

Réf./Item no.	Ø mm
VLX.MMB342	34.20
...	...
VLX.MMB398	39.80

Incréments 0.20 mm du Ø 34.20 au Ø 39.80 mm (préciser le diamètre lors de la commande).
Increment 0.20 mm from Ø 34.20 to Ø 39.80 mm (specify the diameter when ordering).
Inkrementieren 0.20 mm von Ø 34.20 bis Ø 39.80 mm (bei der Bestellung, den Durchmesser angeben).
Incrementar 0.20 mm del Ø 34.20 al Ø 39.80 mm (precisar el diámetro en el pedido).
Incremento 0.20 mm dal Ø 34.20 al Ø 39.80 mm (specificare il diametro al momento dell'ordine).
Incrementar 0.20 mm do Ø 34.20 ao Ø 39.80 mm (precisar o diâmetro na encomenda).

Réf./Item no.	Ø mm
VLX.MMB345	34.50
...	...
VLX.MMB400	40.00

Incréments 0.50 mm du Ø 34.50 au Ø 40.00 mm (préciser le diamètre lors de la commande).
Increment 0.50 mm from Ø 34.50 to Ø 40.00 mm (specify the diameter when ordering).
Inkrementieren 0.50 mm von Ø 34.50 bis Ø 40.00 mm (bei der Bestellung, den Durchmesser angeben).
Incrementar 0.50 mm del Ø 34.50 al Ø 40.00 mm (precisar el diámetro en el pedido).
Incremento 0.50 mm dal Ø 34.50 al Ø 40.00 mm (specificare il diametro al momento dell'ordine).
Incrementar 0.50 mm do Ø 34.50 ao Ø 40.00 mm (precisar o diâmetro na encomenda).



Verre minéral bombé trempé ; épaisseur 2.00 mm.

Tempered domed mineral crystal ; thickness 2.00 mm.

Gehärtetes gewölbtes Mineralglas ; Dicke 2.00 mm.

Cristal mineral bombeado templado ; espesor 2.00 mm.

Vetro minerale bombato temperato ; spessore 2.00 mm.

Vidro mineral encurvado temperado ; espessura 2.00 mm.

Incrémenter 0.10 mm du Ø 24.00 au Ø 33.00 mm (préciser le diamètre lors de la commande).

Increment 0.10 mm from Ø 24.00 to Ø 33.00 mm (specify the diameter when ordering).

Inkrementieren 0.10 mm von Ø 24.00 bis Ø 33.00 mm (bei der Bestellung, den Durchmesser angeben).

Incrementar 0.10 mm del Ø 24.00 al Ø 33.00 mm (precisar el diámetro en el pedido).

Incremento 0.10 mm dal Ø 24.00 al Ø 33.00 mm (specificare il diametro al momento dell'ordine).

Incrementar 0.10 mm do Ø 24.00 ao Ø 33.00 mm (precisar o diâmetro na encomenda).

Réf./Item no.	Ø mm
VLX.MBE240	24.00
...	...
VLX.MBE330	33.00
VLX.MBE335	33.50
VLX.MBE340	34.00
VLX.MBE345	34.50
VLX.MBE350	35.00
VLX.MBE355	35.50

Réf./Item no.	Ø mm
VLX.MBE360	36.00
VLX.MBE365	36.50
VLX.MBE370	37.00
VLX.MBE375	37.50
VLX.MBE380	38.00
VLX.MBE385	38.50
VLX.MBE390	39.00
VLX.MBE395	39.50

Réf./Item no.	Ø mm
VLX.MBE400	40.00
VLX.MBE405	40.50
VLX.MBE410	41.00
VLX.MBE415	41.50
VLX.MBE420	42.00
VLX.MBE425	42.50
VLX.MBE430	43.00



Verre minéral bombé trempé ; épaisseur entre 1.10 et 1.20 mm.

Tempered domed mineral crystal ; thickness between 1.10 and 1.20 mm.

Gehärtetes gewölbtes Mineralglas ; Dicke zwischen 1.10 und 1.20 mm.

Cristal mineral bombeado templado ; espesor entre 1.10 y 1.20 mm.

Vetro minerale bombato temperato ; spessore tra 1.10 e 1.20 mm.

Vidro mineral encurvado temperado ; espessura entre 1.10 e 1.20 mm.

Incrémenter 0.10 mm du Ø 18.00 au Ø 39.50 mm (préciser le diamètre lors de la commande).

Increment 0.10 mm from Ø 18.00 to Ø 39.50 mm (specify the diameter when ordering).

Inkrementieren 0.10 mm von Ø 18.00 bis Ø 39.50 mm (bei der Bestellung, den Durchmesser angeben).

Incrementar 0.10 mm del Ø 18.00 al Ø 39.50 mm (precisar el diámetro en el pedido).

Incremento 0.10 mm dal Ø 18.00 al Ø 39.50 mm (specificare il diametro al momento dell'ordine).

Incrementar 0.10 mm do Ø 18.00 ao Ø 39.50 mm (precisar o diâmetro na encomenda).

Réf./Item no.	Ø mm
VLX.MSB180	18.00
...	...
VLX.MSB395	39.50
VLX.MSB400	40.00

Réf./Item no.	Ø mm
VLX.MSB405	40.50
VLX.MSB410	41.00
VLX.MSB415	41.50
VLX.MSB420	42.00

Réf./Item no.	Ø mm
VLX.MSB425	42.50
VLX.MSB430	43.00

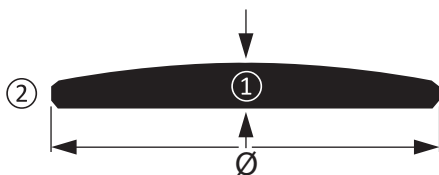

Verre minéral, type loupe.
 Mineral crystal, lens type.
 Mineralglas, Lupe Typ.
 Cristal mineral, tipo lupa.
 Vetro minerale, tipo lente.
 Vidro mineral, tipo lente.

Réf./Item no.	Ø mm	1 mm	2 mm
VLX.XMF155/725	15.50	2.10	1.60
VLX.XMF180/703	18.00	2.10	1.50
VLX.XMF185/726	18.50	2.30	1.60
VLX.XMF190/729	19.00	2.50	1.60
VLX.XMF195/730	19.50	2.50	1.60
VLX.XMF200/716	20.00	2.50	1.25
VLX.XMF205/731	20.50	3.00	1.50
VLX.XMF210/727	21.00	2.50	1.60
VLX.XMF210/735	21.00	4.40	2.40
VLX.XMF215/734	21.50	2.10	1.50
VLX.XMF220/728	22.00	2.50	1.60
VLX.XMF250/732	25.00	2.50	1.60
VLX.XMF256/714	25.60	2.50	1.50
VLX.XMF260/736	26.00	3.20	2.00
VLX.XMF264/713	26.40	2.50	1.50
VLX.XMF265/737	26.50	3.20	2.00
VLX.XMF266/715	26.60	2.50	1.50
VLX.XMF268/742	26.80	3.20	1.60
VLX.XMF270/700	27.00	2.50	1.50
VLX.XMF273/743	27.30	3.20	1.60
VLX.XMF275/701	27.50	2.40	1.60
VLX.XMF278/744	27.80	3.20	1.60
VLX.XMF280/705	28.00	2.50	1.50
VLX.XMF283/745	28.30	3.20	1.60

Réf./Item no.	Ø mm	1 mm	2 mm
VLX.XMF285/706	28.50	2.50	1.50
VLX.XMF288/746	28.80	3.20	1.60
VLX.XMF290/605	29.00	4.40	3.50
VLX.XMF290/707	29.00	2.50	1.50
VLX.XMF290/723	29.00	4.40	2.00
VLX.XMF293/747	29.30	3.20	1.60
VLX.XMF295/708	29.50	2.50	1.60
VLX.XMF296/738	29.60	3.20	2.00
VLX.XMF298/712	29.80	2.50	1.60
VLX.XMF298/721	29.80	4.00	3.20
VLX.XMF299/613	29.90	5.50	3.50
VLX.XMF300/709	30.00	2.50	1.60
VLX.XMF303/748	30.30	3.20	1.60
VLX.XMF305/710	30.50	2.50	1.60
VLX.XMF308/749	30.80	3.20	1.60
VLX.XMF310/711	31.00	2.50	1.60
VLX.XMF313/750	31.30	3.20	1.60
VLX.XMF315/702	31.50	3.60	2.50
VLX.XMF315/718	31.50	2.50	1.20
VLX.XMF320/615	32.00	3.60	2.50
VLX.XMF320/719	32.00	2.50	1.30
VLX.XMF323/616	32.30	3.20	2.00
VLX.XMF325/720	32.50	2.50	1.30
VLX.XMF330/739	33.00	2.50	1.80

Réf./Item no.	Ø mm	1 mm	2 mm
VLX.XMF335/740	33.50	2.50	1.80
VLX.XMF340/741	34.00	2.50	1.80
VLX.XMF345/722	34.50	4.40	2.70
VLX.XMF350/704	35.00	2.70	1.90
VLX.XMF350/717	35.00	3.60	1.20
VLX.XMF355/606	35.50	4.00	2.00
VLX.XMF360/733	36.00	3.50	2.30
VLX.XMF365/607	36.50	4.00	2.00
VLX.XMF365/612	36.50	2.50	1.50
VLX.XMF370/600	37.00	3.40	1.60
VLX.XMF375/601	37.50	3.40	1.60
VLX.XMF380/602	38.00	3.40	1.60
VLX.XMF385/608	38.50	4.00	2.00
VLX.XMF390/609	39.00	4.00	2.00
VLX.XMF394/618	39.40	2.40	1.00
VLX.XMF395/614	39.50	4.00	2.00
VLX.XMF400/603	40.00	4.00	2.00
VLX.XMF405/610	40.50	4.00	2.20
VLX.XMF410/611	41.00	4.00	2.00
VLX.XMF411/619	41.10	2.70	1.30
VLX.XMF450/604	45.00	3.60	1.60
VLX.XMF500/617	50.00	3.60	1.50

Loupe pour verres minéraux.
 Lens for mineral crystals.
 Lupe für Mineralgläsern.
 Lupa para cristales minerales.
 Lente per vetri minerali.
 Lupa para vidros minerais.

Réf./Item no.	Dimensions/Size mm
VLX.ML4.5X3.6	4.50 x 3.60
VLX.ML5.9X4.7	5.90 x 4.70
VLX.ML7.5X6.3	7.50 x 6.30



Réf./Item no.	Ø mm
VLX.SRV120	12.00
VLX.SRV125	12.50
VLX.SRV130	13.00
VLX.SRV135	13.50
VLX.SRV140	14.00
VLX.SRV145	14.50
VLX.SRV150	15.00
VLX.SRV155	15.50
VLX.SRV160	16.00
VLX.SRV165	16.50
VLX.SRV170	17.00
...	...
VLX.SRV210	21.00

Verre saphir plat ; épaisseur 0.80 mm.
Flat sapphire crystal ; thickness 0.80 mm.
 Flaches Saphirglas ; Dicke 0.80 mm.
Cristal zafiro plano ; espesor 0.80 mm.
 Vetro zaffiro piatto ; spessore 0.80 mm.
Vidro safira plano ; espessura 0.80 mm.
Incrémenter 0.10 mm du Ø 17.00 au Ø 21.00 mm (préciser le diamètre lors de la commande).
Increment 0.10 mm from Ø 17.00 to Ø 21.00 mm (specify the diameter when ordering).
Inkrementieren 0.10 mm von Ø 17.00 bis Ø 21.00 mm (bei der Bestellung, den Durchmesser angeben).
Incrementar 0.10 mm del Ø 17.00 al Ø 21.00 mm (precisar el diámetro en el pedido).
Incremento 0.10 mm dal Ø 17.00 al Ø 21.00 mm (specificare il diametro al momento dell'ordine).
Incrementar 0.10 mm do Ø 17.00 ao Ø 21.00 mm (precisar o diâmetro na encomenda).



Réf./Item no.	Ø mm
VLX.SRV211	21.10
...	...
VLX.SRV320	32.00
VLX.SRV325	32.50
VLX.SRV330	33.00
VLX.SRV335	33.50

Verre saphir plat ; épaisseur 0.90 mm.
Flat sapphire crystal ; thickness 0.90 mm.
 Flaches Saphirglas ; Dicke 0.90 mm.
Cristal zafiro plano ; espesor 0.90 mm.
 Vetro zaffiro piatto ; spessore 0.90 mm.
Vidro safira plano ; espessura 0.90 mm.
Incrémenter 0.10 mm du Ø 21.10 au Ø 32.00 mm (préciser le diamètre lors de la commande).
Increment 0.10 mm from Ø 21.10 to Ø 32.00 mm (specify the diameter when ordering).
Inkrementieren 0.10 mm von Ø 21.10 bis Ø 32.00 mm (bei der Bestellung, den Durchmesser angeben).
Incrementar 0.10 mm del Ø 21.10 al Ø 32.00 mm (precisar el diámetro en el pedido).
Incremento 0.10 mm dal Ø 21.10 al Ø 32.00 mm (specificare il diametro al momento dell'ordine).
Incrementar 0.10 mm do Ø 21.10 ao Ø 32.00 mm (precisar o diâmetro na encomenda).



Réf./Item no.	Ø mm
VLX.SRM260	26.00
...	...
VLX.SRM320	32.00
VLX.SRM325	32.50
VLX.SRM330	33.00
VLX.SRM335	33.50

Verre saphir plat ; épaisseur 1.40 mm.
Flat sapphire crystal ; thickness 1.40 mm.
 Flaches Saphirglas ; Dicke 1.40 mm.
Cristal zafiro plano ; espesor 1.40 mm.
 Vetro zaffiro piatto ; spessore 1.40 mm.
Vidro safira plano ; espessura 1.40 mm.
Incrémenter 0.10 mm du Ø 26.00 au Ø 32.00 mm (préciser le diamètre lors de la commande).
Increment 0.10 mm from Ø 26.00 to Ø 32.00 mm (specify the diameter when ordering).
Inkrementieren 0.10 mm von Ø 26.00 bis Ø 32.00 mm (bei der Bestellung, den Durchmesser angeben).
Incrementar 0.10 mm del Ø 26.00 al Ø 32.00 mm (precisar el diámetro en el pedido).
Incremento 0.10 mm dal Ø 26.00 al Ø 32.00 mm (specificare il diametro al momento dell'ordine).
Incrementar 0.10 mm do Ø 26.00 ao Ø 32.00 mm (precisar o diâmetro na encomenda).



Réf./Item no.	Ø mm
VLX.SRD260	26.00
...	...
VLX.SRD320	32.00
VLX.SRD325	32.50
VLX.SRD330	33.00
VLX.SRD335	33.50

Verre saphir bombé ; épaisseur 0.90 mm.
Domed sapphire crystal ; thickness 0.90 mm.
 Gewölbtes Saphirglas ; Dicke 0.90 mm.
Cristal zafiro bombeado ; espesor 0.90 mm.
 Vetro zaffiro bombato ; spessore 0.90 mm.
Vidro safira encurvado ; espessura 0.90 mm.
Incrémenter 0.10 mm du Ø 26.00 au Ø 32.00 mm (préciser le diamètre lors de la commande).
Increment 0.10 mm from Ø 26.00 to Ø 32.00 mm (specify the diameter when ordering).
Inkrementieren 0.10 mm von Ø 26.00 bis Ø 32.00 mm (bei der Bestellung, den Durchmesser angeben).
Incrementar 0.10 mm del Ø 26.00 al Ø 32.00 mm (precisar el diámetro en el pedido).
Incremento 0.10 mm dal Ø 26.00 al Ø 32.00 mm (specificare il diametro al momento dell'ordine).
Incrementar 0.10 mm do Ø 26.00 ao Ø 32.00 mm (precisar o diâmetro na encomenda).

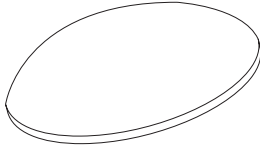

Plaque minérale bombée trempée, forme ronde.

Tempered domed mineral sheet, round shape.

Gehärtete gewölbte Mineralplatten, Runder Form.

Placa mineral bombeada templada, forma redonda.

Lastrina minerale bombata temperata, forma rotonda.

Placa mineral encurvada temperada, forma redonda.

Réf./Item no.	Ø mm	Épaisseur/Thickness mm
VLX.MPL/B22X07	22	0.70
VLX.MPL/B35X09	35	0.90
VLX.MPL/B/SP35X15	35	1.50
VLX.MPL/B/SP36X20	36	2.00

Réf./Item no.	Ø mm	Épaisseur/Thickness mm
VLX.MPL/B/SP40X09	40	0.90
VLX.MPL/B/SP45X12	45	1.20
VLX.MPL/B/SP50X11	50	1.10

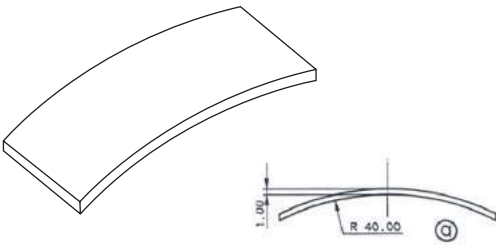

Plaque minérale galbée trempée, forme rectangulaire.

Tempered curved mineral sheet, rectangular shape.

Gehärtete gerundete Mineralplatte, Rechteckiger Form.

Placa mineral curvada templada, forma rectangular.

Lastrina minerale curvata temperata, forma rettangolare.

Placa mineral curvada temperada, forma rectangular.

Réf./Item no.	Dimensions/ Size mm	Galbe/ Curve R
VLX.MPL/G220X160X40	22 x 16	40
VLX.MPL/G220X160X50	22 x 16	50
VLX.MPL/G220X160X60	22 x 16	60
VLX.MPL/G220X160X70	22 x 16	70
VLX.MPL/G220X160X80	22 x 16	80
VLX.MPL/G220X160X100	22 x 16	100
VLX.MPL/G300X200X40	30 x 20	40
VLX.MPL/G300X200X50	30 x 20	50
VLX.MPL/G300X200X60	30 x 20	60
VLX.MPL/G300X200X70	30 x 20	70
VLX.MPL/G300X200X80	30 x 20	80
VLX.MPL/G300X200X100	30 x 20	100
VLX.MPL/G350X250X30	35 x 25	30
VLX.MPL/G350X250X40	35 x 25	40
VLX.MPL/G350X250X50	35 x 25	50
VLX.MPL/G350X250X60	35 x 25	60
VLX.MPL/G350X250X70	35 x 25	70

Réf./Item no.	Dimensions/ Size mm	Galbe/ Curve R
VLX.MPL/G350X250X80	35 x 25	80
VLX.MPL/G350X250X100	35 x 25	100
VLX.MPL/G370X280X40	37 x 28	40
VLX.MPL/G370X280X50	37 x 28	50
VLX.MPL/G370X280X60	37 x 28	60
VLX.MPL/G370X280X70	37 x 28	70
VLX.MPL/G370X280X80	37 x 28	80
VLX.MPL/G370X280X100	37 x 28	100
VLX.MPL/G/SP280X370X60	28 x 37	60
VLX.MPL/G/SP430X320X60	43 x 32	60
VLX.MPL/G/SP430X320X80	43 x 32	80
VLX.MPL/G/SP430X320X100	43 x 32	100
VLX.MPL/G/SP450X320X40	45 x 32	40
VLX.MPL/G/SP500X400X60	50 x 40	60
VLX.MPL/G/SP500X400X80	50 x 40	80
VLX.MPL/G/SP500X400X100	50 x 40	100

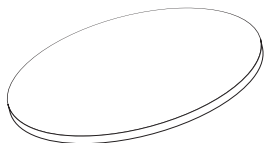

Plaque minérale plate trempée, forme ronde.
 Tempered flat mineral sheet, round shape.
 Gehärtete flache Mineralplatte, Runder Form.
 Placa mineral plana templada, forma redonda.
 Lastrina minerale piatta temperata, forma rotonda.
 Placa mineral plana temperada, forma redonda.

Réf./Item no.	Ø mm	Épaisseur / Thickness mm
VLX.MPL15X07	15	0.70
VLX.MPL15X09	15	0.90
VLX.MPL15X11	15	1.10
VLX.MPL20X07	20	0.70
VLX.MPL20X09	20	0.90
VLX.MPL20X11	20	1.10
VLX.MPL25X07	25	0.70
VLX.MPL25X09	25	0.90
VLX.MPL25X11	25	1.10
VLX.MPL30X07	30	0.70
VLX.MPL30X09	30	0.90

Réf./Item no.	Ø mm	Épaisseur / Thickness mm
VLX.MPL30X11	30	1.10
VLX.MPL30X13	30	1.30
VLX.MPL35X07	35	0.70
VLX.MPL35X09	35	0.90
VLX.MPL35X11	35	1.10
VLX.MPL35X13	35	1.30
VLX.MPL40X07	40	0.70
VLX.MPL40X09	40	0.90
VLX.MPL40X11	40	1.10
VLX.MPL40X13	40	1.30
VLX.MPL40X15	40	1.50

Réf./Item no.	Ø mm	Épaisseur / Thickness mm
VLX.MPL40X18	40	1.80
VLX.MPL/SP40X25	40	2.50
VLX.MPL/SP40X30	40	3.00
VLX.MPL45X09	45	0.90
VLX.MPL45X11	45	1.10
VLX.MPL45X13	45	1.30
VLX.MPL/SP50X09	50	0.90
VLX.MPL/SP50X25	50	2.50
VLX.MPL/SP55X11	55	1.10
VLX.MPL/SP55X16	55	1.65
VLX.MPL/SP55X20	55	2.00

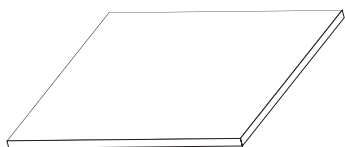

Plaque minérale plate trempée, forme carrée.
 Tempered flat mineral sheet, square shape.
 Gehärtete flache Mineralplatte, Viereckiger Form.
 Placa mineral plana templada, forma cuadrada.
 Lastrina minerale piatta temperata, forma quadrata.
 Placa mineral plana temperada, forma quadrada.

Réf./Item no.	Dim./ Size mm	Épaisseur / Thickness mm
VLX.MPL15X15X07	15 x 15	0.70
VLX.MPL15X15X09	15 x 15	0.90
VLX.MPL15X15X11	15 x 15	1.10
VLX.MPL20X20X07	20 x 20	0.70
VLX.MPL20X20X09	20 x 20	0.90
VLX.MPL20X20X11	20 x 20	1.10
VLX.MPL25X25X07	25 x 25	0.70
VLX.MPL25X25X09	25 x 25	0.90

Réf./Item no.	Dim./ Size mm	Épaisseur / Thickness mm
VLX.MPL25X25X11	25 x 25	1.10
VLX.MPL25X25X13	25 x 25	1.30
VLX.MPL30X30X07	30 x 30	0.70
VLX.MPL30X30X09	30 x 30	0.90
VLX.MPL30X30X11	30 x 30	1.10
VLX.MPL30X30X13	30 x 30	1.30
VLX.MPL35X35X07	35 x 35	0.70
VLX.MPL35X35X09	35 x 35	0.90

Réf./Item no.	Dim./ Size mm	Épaisseur / Thickness mm
VLX.MPL35X35X11	35 x 35	1.10
VLX.MPL35X35X13	35 x 35	1.30
VLX.MPL35X35X15	35 x 35	1.50
VLX.MPL35X35X18	35 x 35	1.80
VLX.MPL40X40X09	40 x 40	0.90
VLX.MPL40X40X11	40 x 40	1.10
VLX.MPL40X40X13	40 x 40	1.30



Réf./Item no.	Ø mm
VLX.NML90	9.00
...	...
VLX.NML380	38.00
VLX.NML382	38.20
...	...
VLX.NML700	70.00

Verre en plexiglas normalisé, à poser sous tension.

Snap-in standardized plexiglas crystal.

Normalisiertes Glas aus Plexiglas, unter Spannung einzustellen.

Cristal en plexiglás normalizado, para colocar bajo tensión.

Vetro in plexiglas normalizzato, da incassare a pressione.

Vidro em plexiglas normalizado, para colocar à pressão.

Incrémenter 0.10 mm du Ø 9.00 au Ø 38.00 mm (préciser le diamètre lors de la commande).

Increment 0.10 mm from Ø 9.00 to Ø 38.00 mm (specify the diameter when ordering).

Inkrementieren 0.10 mm von Ø 9.00 bis Ø 38.00 mm (bei der Bestellung, den Durchmesser angeben).

Incrementar 0.10 mm del Ø 9.00 al Ø 38.00 mm (precisar el diámetro en el pedido).

Incremento 0.10 mm dal Ø 9.00 al Ø 38.00 mm (specificare il diametro al momento dell'ordine).

Incrementar 0.10 mm do Ø 9.00 ao Ø 38.00 mm (precisar o diâmetro na encomenda).

Incrémenter 0.20 mm du Ø 38.20 au Ø 70.00 mm (préciser le diamètre lors de la commande).

Increment 0.20 mm from Ø 38.20 to Ø 70.00 mm (specify the diameter when ordering).

Inkrementieren 0.20 mm von Ø 38.20 bis Ø 70.00 mm (bei der Bestellung, den Durchmesser angeben).

Incrementar 0.20 mm del Ø 38.20 al Ø 70.00 mm (precisar el diámetro en el pedido).

Incremento 0.20 mm dal Ø 38.20 al Ø 70.00 mm (specificare il diametro al momento dell'ordine).

Incrementar 0.20 mm do Ø 38.20 ao Ø 70.00 mm (precisar o diâmetro na encomenda).



Réf./Item no.	Ø mm
VLX.ETC120*	12.00
...*	...
VLX.ETC380*	38.00

*Selon disponibilité / Upon availability
 Nach Verfügbarkeit / Según disponibilidad
 Se disponibile / Se disponível

Verre en plexiglas étanche, à poser sous tension.

Snap-in waterproof plexiglas crystal.

Wasserdichtes Glas aus Plexiglas, unter Spannung einzustellen.

Cristal en plexiglás hermético, para colocar bajo tensión.

Vetro in plexiglas impermeabile, da incassare a pressione.

Vidro em plexiglas estanque, para colocar à pressão.

Incrémenter 0.10 mm du Ø 12.00 au Ø 38.00 mm (Préciser le diamètre lors de la commande).

Incémenter 0.10 mm du Ø 12.00 au Ø 38.00 mm (préciser le diamètre lors de la commande).

Increment 0.10 mm from Ø 12.00 to Ø 38.00 mm (specify the diameter when ordering).

Inkrementieren 0.10 mm von Ø 12.00 bis Ø 38.00 mm (bei der Bestellung, den Durchmesser angeben).

Incrementar 0.10 mm del Ø 12.00 al Ø 38.00 mm (precisar el diámetro en el pedido).

Incremento 0.10 mm dal Ø 12.00 al Ø 38.00 mm (specificare il diametro al momento dell'ordine).

Incrementar 0.10 mm do Ø 12.00 ao Ø 38.00 mm (precisar o diâmetro na encomenda).



Réf./Item no.	Ø mm
VLX.MDN90	9.00
...	...
VLX.MDN380	38.00

Verre en plexiglas moderne, à poser sous tension.

Snap-in modern plexiglas crystal.

Modernes Glas aus Plexiglas, unter Spannung einzustellen.

Cristal en plexiglás moderno, para colocar bajo tensión.

Vetro in plexiglas moderno, da incassare a pressione.

Vidro em plexiglas moderno, para colocar à pressão.

Incémenter 0.10 mm du Ø 9.00 au Ø 38.00 mm (préciser le diamètre lors de la commande).

Increment 0.10 mm from Ø 9.00 to Ø 38.00 mm (specify the diameter when ordering).

Inkrementieren 0.10 mm von Ø 9.00 bis Ø 38.00 mm (bei der Bestellung, den Durchmesser angeben).

Incrementar 0.10 mm del Ø 9.00 al Ø 38.00 mm (precisar el diámetro en el pedido).

Incremento 0.10 mm dal Ø 9.00 al Ø 38.00 mm (specificare il diametro al momento dell'ordine).

Incrementar 0.10 mm do Ø 9.00 ao Ø 38.00 mm (precisar o diâmetro na encomenda).



Réf./Item no.	Ø mm
VLX.NMB100	10.00
...	...
VLX.NMB500	50.00

Verre en plexiglas "normabas", à poser sous tension.

Snap-in "normabas" plexiglas crystal.

"Normabas" Glas aus Plexiglas, unter Spannung einzustellen.

Cristal en plexiglás "normabas", para colocar bajo tensión.

Vetro in plexiglas "normabas", da incassare a pressione.

Vidro em plexiglas "normabas", para colocar à pressão.

Incrémenter 0.20 mm du Ø 10.00 au Ø 50.00 mm (préciser le diamètre lors de la commande).

Increment 0.20 mm from Ø 10.00 to Ø 50.00 mm (specify the diameter when ordering).

Inkrementieren 0.20 mm von Ø 10.00 bis Ø 50.00 mm (bei der Bestellung, den Durchmesser angeben).

Incrementar 0.20 mm del Ø 10.00 al Ø 50.00 mm (precisar el diámetro en el pedido).

Incremento 0.20 mm dal Ø 10.00 al Ø 50.00 mm (specificare il diametro al momento dell'ordine).

Incrementar 0.20 mm do Ø 10.00 ao Ø 50.00 mm (precisar o diâmetro na encomenda).



Réf./Item no.	Ø mm
VLX.MCV164	16.40
...	...
VLX.MCV500	50.00

Verre en plexiglas de forme semi-concave, à poser sous tension.

Snap-in half concave shape plexiglas crystal.

Halbkonkav-Form Glas aus Plexiglas, unter Spannung einzustellen.

Cristal en plexiglás de forma mitad cóncava, para colocar bajo tensión.

Vetro in plexiglas di forma mezza concava, da incassare a pressione.

Vidro em plexiglas de forma meia cóncava, para colocar à pressão.

Incrémenter 0.20 mm du Ø 16.40 au Ø 50.00 mm (préciser le diamètre lors de la commande).

Increment 0.20 mm from Ø 16.40 to Ø 50.00 mm (specify the diameter when ordering).

Inkrementieren 0.20 mm von Ø 16.40 bis Ø 50.00 mm (bei der Bestellung, den Durchmesser angeben).

Incrementar 0.20 mm del Ø 16.40 al Ø 50.00 mm (precisar el diámetro en el pedido).

Incremento 0.20 mm dal Ø 16.40 al Ø 50.00 mm (specificare il diametro al momento dell'ordine).

Incrementar 0.20 mm do Ø 16.40 ao Ø 50.00 mm (precisar o diâmetro na encomenda).



Réf./Item no.	Ø mm
VLX.SVN200	20.00
...	...
VLX.SVN500	50.00

Verre en plexiglas de forme savonnette, à poser sous tension.

Snap-in hunter shape plexiglas crystal.

Savonnette-Form Glas aus Plexiglas, unter Spannung einzustellen.

Cristal en plexiglás de forma saboneta, para colocar bajo tensión.

Vetro in plexiglas di forma saponetta, da incassare a pressione.

Vidro em plexiglas de forma sabonete, para colocar à pressão.

Incrémenter 0.20 mm du Ø 20.00 au Ø 50.00 mm (préciser le diamètre lors de la commande).

Increment 0.20 mm from Ø 20.00 to Ø 50.00 mm (specify the diameter when ordering).

Inkrementieren 0.20 mm von Ø 20.00 bis Ø 50.00 mm (bei der Bestellung, den Durchmesser angeben).

Incrementar 0.20 mm del Ø 20.00 al Ø 50.00 mm (precisar el diámetro en el pedido).

Incremento 0.20 mm dal Ø 20.00 al Ø 50.00 mm (specificare il diametro al momento dell'ordine).

Incrementar 0.20 mm do Ø 20.00 ao Ø 50.00 mm (precisar o diâmetro na encomenda).



Réf./Item no.	Ø mm
VLX.MTL/C141	14.10
...	...
VLX.MTL/C373	37.30

Verre rond en plexiglas avec bague de tension chromée.

Round plexiglas crystal with chromed tension ring.

Rundes Glas aus Plexiglas mit verchromtem Spannungsring.

Cristal redondo en plexiglás con aro de tensión cromado.

Vetro rotondo in plexiglas con ghiera di tensione cromata.

Vidro redondo em plexiglas com aro de tensão cromado.

Incrémenter 0.10 mm du Ø 14.10 au Ø 37.30 mm (préciser le diamètre lors de la commande).

Increment 0.10 mm from Ø 14.10 to Ø 37.30 mm (specify the diameter when ordering).

Inkrementieren 0.10 mm von Ø 14.10 bis Ø 37.30 mm (bei der Bestellung, den Durchmesser angeben).

Incrementar 0.10 mm del Ø 14.10 al Ø 37.30 mm (precisar el diámetro en el pedido).

Incremento 0.10 mm dal Ø 14.10 al Ø 37.30 mm (specificare il diametro al momento dell'ordine).

Incrementar 0.10 mm do Ø 14.10 ao Ø 37.30 mm (precisar o diâmetro na encomenda).



Réf./Item no.	Ø mm
VLX.MTL/D141	14.10
...	...
VLX.MTL/D373	37.30

Verre rond en plexiglas avec bague de tension dorée.

Round plexiglas crystal with gilt tension ring.

Rundes Glas aus Plexiglas mit vergoldetem Spannungsring.

Cristal redondo en plexiglás con aro de tensión dorado.

Vetro rotondo in plexiglas con ghiera di tensione dorata.

Vidro redondo em plexiglas com aro de tensão dourado.

Incrémenter 0.10 mm du Ø 14.10 au Ø 37.30 mm (préciser le diamètre lors de la commande).

Increment 0.10 mm from Ø 14.10 to Ø 37.30 mm (specify the diameter when ordering).

Inkrementieren 0.10 mm von Ø 14.10 bis Ø 37.30 mm (bei der Bestellung, den Durchmesser angeben).

Incrementar 0.10 mm del Ø 14.10 al Ø 37.30 mm (precisar el diámetro en el pedido).

Incremento 0.10 mm dal Ø 14.10 al Ø 37.30 mm (specificare il diametro al momento dell'ordine).

Incrementar 0.10 mm do Ø 14.10 ao Ø 37.30 mm (precisar o diâmetro na encomenda).

» Joints/Gaskets "I"



Réf./Item no.	Ø mm
VLX.JOINT/I140X08	14.00
...	...
VLX.JOINT/I340X08	34.00

Réf./Item no.	Ø mm
VLX.JOINT/I342X08	34.20
...	...
VLX.JOINT/I400X08	40.00

Réf./Item no.	Ø mm
VLX.JOINT/I345X08	34.50
VLX.JOINT/I355X08	35.50
VLX.JOINT/I365X08	36.50
VLX.JOINT/I375X08	37.50
VLX.JOINT/I385X08	38.50
VLX.JOINT/I395X08	39.50

Plastic Hytrel

Joint "I" pour verres minéraux minces ; hauteur 0.80 mm, épaisseur 0.35 mm.

"I" gasket for thin mineral crystals ; height 0.80 mm, thickness 0.35 mm.

"I" Dichtung für dünne Mineralgläsern ; Höhe 0.80 mm, Dicke 0.35 mm.

Junta "I" para vidrios minerales finos ; altura 0.80 mm, espesor 0.35 mm.

Guarnizione "I" per vetri minerali sottili ; altezza 0.80 mm, spessore 0.35 mm.

Junta "I" para vidros minerais finos ; altura 0.80 mm, espessura 0.35 mm.

Incrémenter 0.10 mm du Ø 14.00 au Ø 34.00 mm (préciser le diamètre lors de la commande).

Increment 0.10 mm from Ø 14.00 to Ø 34.00 mm (specify the diameter when ordering).

Inkrementieren 0.10 mm von Ø 14.00 bis Ø 34.00 mm (bei der Bestellung, den Durchmesser angeben).

Incrementar 0.10 mm del Ø 14.00 al Ø 34.00 mm (precisar el diámetro en el pedido).

Incremento 0.10 mm dal Ø 14.00 al Ø 34.00 mm (specificare il diametro al momento dell'ordine).

Incrementar 0.10 mm do Ø 14.00 ao Ø 34.00 mm (precisar o diâmetro na encomenda).

Incrémenter 0.20 mm du Ø 34.20 au Ø 40.00 mm (préciser le diamètre lors de la commande).

Increment 0.20 mm from Ø 34.20 to Ø 40.00 mm (specify the diameter when ordering).

Inkrementieren 0.20 mm von Ø 34.20 bis Ø 40.00 mm (bei der Bestellung, den Durchmesser angeben).

Incrementar 0.20 mm del Ø 34.20 al Ø 40.00 mm (precisar el diámetro en el pedido).

Incremento 0.20 mm dal Ø 34.20 al Ø 40.00 mm (specificare il diametro al momento dell'ordine).

Incrementar 0.20 mm do Ø 34.20 ao Ø 40.00 mm (precisar o diâmetro na encomenda).

» Joints/Gaskets "I"



Réf./Item no.	Ø mm
VLX.JOINT/I250X12	25.00
...	...
VLX.JOINT/I327X12	32.70
VLX.JOINT/I330X12	33.00
VLX.JOINT/I335X12	33.50
VLX.JOINT/I340X12	34.00
VLX.JOINT/I345X12	34.50

Plastic Hytrel

Joint "I" pour verres minéraux épais ; hauteur 1.20 mm, épaisseur 0.40 mm.

"I" gasket for thick mineral crystals ; height 1.20 mm, thickness 0.40 mm.

"I" Dichtung für dicke Mineralgläsern ; Höhe 1.20 mm, Dicke 0.40 mm.

Junta "I" para vidrios minerales gruesos ; altura 1.20 mm, espesor 0.40 mm.

Guarnizione "I" per vetri minerali spessi ; altezza 1.20 mm, spessore 0.40 mm.

Junta "I" para vidros minerais espessos ; altura 1.20 mm, espessura 0.40 mm.

Incrémenter 0.10 mm du Ø 25.00 au Ø 32.70 mm (préciser le diamètre lors de la commande).

Increment 0.10 mm from Ø 25.00 to Ø 32.70 mm (specify the diameter when ordering).

Inkrementieren 0.10 mm von Ø 25.00 bis Ø 32.70 mm (bei der Bestellung, den Durchmesser angeben).

Incrementar 0.10 mm del Ø 25.00 al Ø 32.70 mm (precisar el diámetro en el pedido).

Incremento 0.10 mm dal Ø 25.00 al Ø 32.70 mm (specificare il diametro al momento dell'ordine).

Incrementar 0.10 mm do Ø 25.00 ao Ø 32.70 mm (precisar o diâmetro na encomenda).

Réf./Item no.	Ø mm	Réf./Item no.	Ø mm
VLX.JOINT/I350X12	35.00	VLX.JOINT/I380X12	38.00
VLX.JOINT/I355X12	35.50	VLX.JOINT/I385X12	38.50
VLX.JOINT/I360X12	36.00	VLX.JOINT/I390X12	39.00
VLX.JOINT/I365X12	36.50	VLX.JOINT/I395X12	39.50
VLX.JOINT/I370X12	37.00	VLX.JOINT/I400X12	40.00
VLX.JOINT/I375X12	37.50	VLX.JOINT/I405X12	40.50

» Joints/Gaskets "L"

Zytel (polyamide nylon)



Joint "L" pour verres minéraux épais.

"L" gasket for thick mineral crystals.

"L" Dichtung für dicke Mineralgläsern.

Junta "L" para vidrios minerales gruesos.

Guarnizione "L" per vetri minerali spessi.

Junta "L" para vidros minerais espessos.

Réf./Item no.	Ø mm	Réf./Item no.	Ø mm	Réf./Item no.	Ø mm
VLX.JOINT/L175	17.50	VLX.JOINT/L240	24.00	VLX.JOINT/L305	30.50
VLX.JOINT/L180	18.00	VLX.JOINT/L245	24.50	VLX.JOINT/L310	31.00
VLX.JOINT/L185	18.50	VLX.JOINT/L250	25.00	VLX.JOINT/L315	31.50
VLX.JOINT/L190	19.00	VLX.JOINT/L255	25.50	VLX.JOINT/L320	32.00
VLX.JOINT/L195	19.50	VLX.JOINT/L260	26.00	VLX.JOINT/L325	32.50
VLX.JOINT/L200	20.00	VLX.JOINT/L265	26.50	VLX.JOINT/L330	33.00
VLX.JOINT/L205	20.50	VLX.JOINT/L270	27.00	VLX.JOINT/L335	33.50
VLX.JOINT/L210	21.00	VLX.JOINT/L275	27.50	VLX.JOINT/L340	34.00
VLX.JOINT/L215	21.50	VLX.JOINT/L280	28.00	VLX.JOINT/L345	34.50
VLX.JOINT/L220	22.00	VLX.JOINT/L285	28.50	VLX.JOINT/L350	35.00
VLX.JOINT/L225	22.50	VLX.JOINT/L290	29.00	VLX.JOINT/L355	35.50
VLX.JOINT/L230	23.00	VLX.JOINT/L295	29.50	VLX.JOINT/L360	36.00
VLX.JOINT/L235	23.50	VLX.JOINT/L300	30.00	VLX.JOINT/L365	36.50

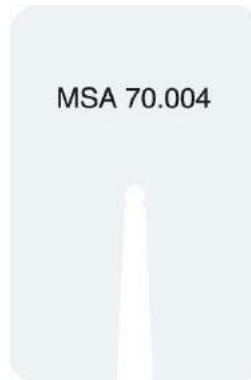
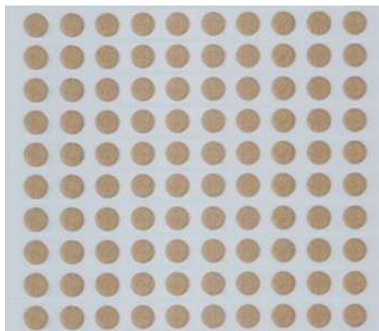

ÉTIQUETTES AUTOCOLLANTES ■ SELF-ADHESIVE LABELS ■ SELBSTKLEBENDE ETIKETTEN 12 - 2
 ETIQUETAS AUTOADHESIVAS ■ ETICHETTE AUTOADESIVE

ÉTIQUETTES ÉLECTROSTATIQUES ■ ELECTROSTATIC LABELS ■ ELEKTROSTATISCHE ETIKETTEN 12 - 4
 ETIQUETAS ELECTROSTÁTICAS ■ ADESIVI ELETTROSTATICI

FILMS ET RUBANS DE PROTECTION ■ PROTECTIVE FILMS AND RIBBONS ■ SCHUTZFILME UND 12 - 6
 KLEBEBÄNDER
 FILMS Y CINTAS DE PROTECCIÓN ■ PELLICOLE E NASTRI DI PROTEZIONE

RONDELLES DE PROTECTION ■ PROTECTION WASHERS ■ SCHUTZWACHE 12 - 7
 ARANDELAS DE PROTECCIÓN ■ RONDELLE DI PROTEZIONE

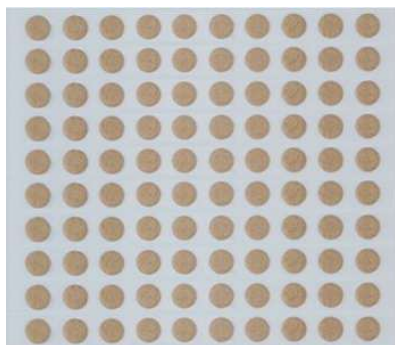

100 pièces / pieces / Stück / piezas / pezzi

MSA	Ø mm	Kg
70.001	3	0.001

Autocollant rond pour cadrans ; sachet de 100 pièces.
 Round self-adhesive sticker for dials ; bag of 100 pieces.
 Runder Aufkleber für Zifferblättern ; Beutel mit 100 Stück.
 Autoadhesivo redondo para esferas ; bolsita de 100 piezas.
 Adesivo tondo per quadranti ; bustina da 100 pezzi.



100 pièces / pieces / Stück / piezas / pezzi

MSA	Dimensions / Size mm	Kg
70.002	12 x 2	0.002

Autocollant rectangulaire pour cadrans ; sachet de 100 pièces.
 Rechteckiger Aufkleber für Zifferblättern ; Beutel mit 100 Stück.
 Rectangular self-adhesive sticker for dials ; bag of 100 pieces.
 Autoadhesivo rectangular para esferas ; bolsita de 100 piezas.
 Adesivo rettangolare per quadranti ; bustina da 100 pezzi.



MSA	Ø mm	Kg
70.004	25 x 38 x 0.20	0.001

Protège cadran en matière synthétique, à utiliser lors de l'extraction des aiguilles.
 Dial protection of synthetic material, used during hands removing.
 Zifferblattschutz aus Kunststoff, verwendet während Zeiger Abhebung.
 Protector de esfera en materia sintética, utilizar durante la extracción de agujas.
 Protezione per quadrante in materia sintetica, da utilizzare durante l'estrazione delle lancette.



100 pièces / pieces / Stück / piezas / pezzi

Etiquette autocollante de protection avec marque rouge et onglet non gommé pour les fonds de boîte ; sachet de 100 pièces.
 Protection self-adhesive label with red mark and adhesive free lip for watch case backs ; bag of 100 pieces.
 Selbstklebende Schutzetikette mit rotem Zeichen und klebfreiem Gehrung für Uhrgehäuseböden ; Beutel mit 100 Stück.
 Etiqueta autoadhesiva de protección con marca roja y uñeta sin adhesivo para fondos de cajas ; bolsita de 100 piezas.
 Adesivo di protezione con segno rosso e linguetta senza adesivo per fondo di cassa ; bustina da 100 pezzi.

MSA		Ø mm	Kg	MSA	Ø mm	Kg	MSA	Ø mm	Kg
70.006-10	*	10	0.007	70.006-24	24	0.015	70.006-36	36	0.031
70.006-12	*	12	0.008	70.006-25	25	0.016	70.006-38	38	0.032
70.006-16		16	0.009	70.006-26	26	0.016	70.006-40	40	0.034
70.006-17		17	0.009	70.006-27	27	0.017	70.006-42	42	0.036
70.006-18		18	0.011	70.006-28	28	0.018	70.006-45	45	0.042
70.006-19		19	0.012	70.006-30	30	0.020	70.006-50	50	0.053
70.006-20		20	0.012	70.006-32	32	0.024	70.006-55	55	0.066
70.006-22		22	0.013	70.006-34	34	0.026	70.006-60	60	0.082

* Jusqu'à épuisement des stocks / Will be discontinued after end of stock / Solange Vorrat
 Hasta agotamiento del stock / Fino ad esaurimento dello stock



1000 pièces / pieces / Stück / piezas / pezzi

Etiquette autocollante de protection avec marque rouge et onglet non gommé pour les fonds de boîte ; rouleau de 1'000 pièces.
 Protection self-adhesive label with red mark and adhesive free lip for watch case backs ; roll of 1'000 pieces.
 Selbstklebende Schutzetikette mit rotem Zeichen und klebfreiem Gehrung für Uhrgehäuseböden ; Rolle mit 1'000 Stück.
 Etiqueta autoadhesiva de protección con marca roja y uñeta sin adhesivo para fondos de cajas ; rollo de 1'000 piezas.
 Adesivo di protezione con segno rosso e linguetta senza adesivo per fondo di cassa ; rotolo da 1'000 pezzi.

MSA		Ø mm	Kg	MSA	Ø mm	Kg	MSA	Ø mm	Kg
70.016-10	*	10	0.054	70.016-25	25	0.145	70.016-38	38	0.303
70.016-16		16	0.085	70.016-26	26	0.149	70.016-40	40	0.322
70.016-17		17	0.091	70.016-27	27	0.156	70.016-42	42	0.355
70.016-18		18	0.098	70.016-28	28	0.193	70.016-45	45	0.460
70.016-19		19	0.100	70.016-30	30	0.206	70.016-50	50	0.575
70.016-20		20	0.111	70.016-32	32	0.230	70.016-55	55	0.718
70.016-22		22	0.120	70.016-34	34	0.251	70.016-60	60	0.898
70.016-24		24	0.135	70.016-36	36	0.301			

* Jusqu'à épuisement des stocks / Will be discontinued after end of stock / Solange Vorrat
 Hasta agotamiento del stock / Fino ad esaurimento dello stock



100 pièces / pieces / Stück / piezas / pezzi

Étiquette électrostatique de protection ; sachet de 100 pièces.
Electrostatic protection label ; bag of 100 pieces.
Elektrostatische Schutzetikette ; Beutel mit 100 Stück.
Etiqueta electrostática de protección ; bolsita de 100 piezas.
Adesivo elettrostatico di protezione ; bustina da 100 pezzi.

MSA	Ø mm	Kg	MSA	Ø mm	Kg	MSA	Ø mm	Kg
70.003-15	15	0.009	70.003-26	26	0.022	70.003-38	38	0.042
70.003-16	16	0.009	70.003-27	27	0.023	70.003-40	40	0.047
70.003-18	18	0.010	70.003-28	28	0.024	70.003-42	42	0.053
70.003-20	20	0.011	70.003-30	30	0.026	70.003-45	45	0.060
70.003-22	22	0.015	70.003-32	32	0.029	70.003-50	50	0.075
70.003-24	24	0.019	70.003-34	34	0.032	70.003-55	55	0.094
70.003-25	25	0.020	70.003-36	36	0.035	70.003-60	60	0.118

* Jusqu'à épuisement des stocks / Will be discontinued after end of stock / Solange Vorrat / Hasta agotamiento del stock / Fino ad esaurimento dello stock



1000 pièces / pieces / Stück / piezas / pezzi

Étiquette électrostatique de protection ; rouleau de 1'000 pièces.
Electrostatic protection label ; roll of 1'000 pieces.
Elektrostatische Schutzetikette ; Rolle mit 1'000 Stück.
Etiqueta electrostática de protección ; rollo de 1'000 piezas.
Adesivo elettrostatico di protezione ; rotolo da 1'000 pezzi.

MSA	Ø mm	Kg	MSA	Ø mm	Kg	MSA	Ø mm	Kg
70.013-15	15	0.086	70.013-28	28	0.211	70.013-40	40	0.460
70.013-20	20	0.127	70.013-30	30	0.253	70.013-42	42	0.520
70.013-22	22	0.082	70.013-32	32	0.308	70.013-45	45	0.620
70.013-24	24	0.098	70.013-34	34	0.346	70.013-50	50	0.775
70.013-25	25	0.186	70.013-36	36	0.201	70.013-55	55	0.968
70.013-26	26	0.178	70.013-38	38	0.410	70.013-60	60	1.210

* Jusqu'à épuisement des stocks / Will be discontinued after end of stock / Solange Vorrat / Hasta agotamiento del stock / Fino ad esaurimento dello stock



MSA	Largeur / Width mm	Longueur / Length m	Kg
70.008-150	150	10	0.590

Bande électrostatique de protection ; rouleau de 10 mètres.
Electrostatic protection tape ; roll of 10 metres.
Elektrostatiches Schutzband ; Rolle von 10 Metern.
Cinta electrostática de protección ; rollo de 10 metros.
Striscia elettrostatica di protezione ; rotolo da 10 metri.



100 pièces / pieces / Stück / piezas / pezzi

MSA	Dimensions / Size mm	Kg
70.008-60	60 x 60	0.117

Etiquette électrostatique de protection ; sachet de 100 pièces.
 Electrostatic protection label ; bag of 100 pieces.
 Elektrostatische Schutzetikette ; Beutel mit 100 Stück.
 Etiqueta electrostática de protección ; bolsita de 100 piezas.
 Adesivo elettrostatico di protezione ; bustina da 100 pezzi.



1000 pièces / pieces / Stück / piezas / pezzi

MSA	Dimensions / Size mm	Kg
70.008-60-A	60 x 60	1.080
70.008-70 *	70 x 50	1.095

Etiquette électrostatique de protection ; rouleau de 1'000 pièces.
 Electrostatic protection label ; roll of 1'000 pieces.
 Elektrostatische Schutzetikette ; Rolle mit 1'000 Stück.
 Etiqueta electrostática de protección ; rollo de 1'000 piezas.
 Adesivo elettrostatico di protezione ; rotolo da 1'000 pezzi.

* *Jusqu'à épuisement des stocks / Will be discontinued after end of stock / Solange Vorrat / Hasta agotamiento del stock / Fino ad esaurimento dello stock*



1000 pièces / pieces / Stück / piezas / pezzi

MSA	Dimensions / Size mm	Kg
70.008-A4	297 x 210	0.023

Feuille électrostatique de protection ; format A4.
 Electrostatic protection sheet ; A4 size.
 Elektrostatische Schutzblatt ; A4 Format.
 Hoja electrostática de protección ; formato A4.
 Foglio elettrostatico di protezione ; formato A4.



MSA	Largeur / Width mm	Longueur / Length m	Épaisseur / Thickness mm	Kg
70.009-050	50	50	0.07	0.250
70.009-100	100	50	0.12	0.650
70.009-150	150	50	0.14	1.200
70.009-200	200	25	0.15	0.800

Bande électrostatique de protection ; rouleau de 25 ou 50 mètres.
 Electrostatic protection tape ; roll of 25 or 50 metres.
 Elektrostatisches Schutzband ; Rolle von 25 oder 50 Metern.
 Cinta electrostática de protección ; rollo de 25 ó 50 metros.
 Striscia elettrostatica di protezione ; rotolo da 25 o 50 metri.



Film PVC de protection légèrement adhésif, épaisseur 75 µm ; rouleau de 100 mètres.
 Protective PVC film softly adhesive, thickness 75 µm ; roll of 100 meters.
 PVC Schutzfolie leicht selbstklebend, Dicke 75 µm ; Rolle von 100 Metern.
 Película PVC de protección ligeramente adhesiva, espesor 75 µm ; rollo de 100 metros.
 Pellicola PVC di protezione leggermente adesiva, spessore 75 µm ; rotolo da 100 metri.

MSA	Largeur / Width mm	Couleur / Colour	Kg
70.010-4	4	Bleu / Blue	0.046
70.010-5	5	Bleu / Blue	0.058
70.010-5/W	5	Transparent	0.058
70.010-6	6	Bleu / Blue	0.069
70.010-8	8	Bleu / Blue	0.092
70.010-10	10	Bleu / Blue	0.115
70.010-12	12	Bleu / Blue	0.138
70.010-14	14	Bleu / Blue	0.161
70.010-15	15	Bleu / Blue	0.173
70.010-20	20	Bleu / Blue	0.230
70.010-25	25	Bleu / Blue	0.288

MSA	Largeur / Width mm	Couleur / Colour	Kg
70.010-30	30	Bleu / Blue	0.345
70.010-35	35	Bleu / Blue	0.403
70.010-40	40	Bleu / Blue	0.460
70.010-40/W	40	Transparent	0.460
70.010-45	45	Bleu / Blue	0.518
70.010-50	50	Bleu / Blue	0.575
70.010-50/W	50	Transparent	0.575
70.010-55	55	Bleu / Blue	0.633
70.010-60	60	Bleu / Blue	0.690
70.010-65	65	Bleu / Blue	0.748
70.010-65/W	65	Transparent	0.748

Toutes les largeurs sont disponibles en bleu ou transparent (autres largeurs sur demande)
All widths are available in blue or transparent (other widths on request)
Alle Breiten sind in blau oder transparent verfügbar (weitere Breiten auf Anfrage)
Todas las anchuras son disponibles en azul y transparente (otras anchuras sobre pedido)
Tutte le larghezze sono disponibili in blu e trasparente (altre larghezze su richiesta)



Ruban spécial en polyimide Kapton pour bracelets et boîtes de montre ; rouleau de 33 mètres.
 Special ribbon in Kapton polyimide for bracelets and watch cases ; roll of 33 meters.
 Spezialklebeband aus Kapton Polyimid für Armbänder und Uhrgehäuse ; Rolle von 33 Metern.
 Cinta especial en poliimida Kapton para brazaletes y cajas de reloj ; rollo de 33 metros.
 Nastro speciale in poliimide Kapton per cinturini e casse di orologio ; rotolo da 33 metri.

MSA	Largeur / Width mm	Kg
70.007-02	2.00	0.008
70.007-03	3.00	0.010
70.007-04	4.00	0.014
70.007-04.4	4.40	0.015
70.007-05	5.00	0.017
70.007-5.15	5.15	0.017
70.007-5.75	5.75	0.020
70.007-06	6.00	0.021
70.007-06.5	6.50	0.023

MSA	Largeur / Width mm	Kg
70.007-6.95	6.95	0.024
70.007-07	7.00	0.025
70.007-07.5	7.50	0.027
70.007-8.05	8.05	0.028
70.007-08.8	8.80	0.030
70.007-09	9.00	0.032
70.007-10	10.00	0.035
70.007-12	12.00	0.042
70.007-20	20.00	0.069



5 pièces / pieces / Stück / piezas / pezzi

MSA	Ø mm	Épaisseur / Thickness mm	Kg
70.020-060	60	0.06	0.006

Rondelle de protection multi-usage en silicone ; sachet de 5 pièces.
 Multi-purpose silicon protection washer ; bag of 5 pieces.
 Mehrzweck Silikon-Schutzwasche ; Beutel mit 5 Stück.
 Arandela de protección multiuso en silicona ; bolsita de 5 piezas.
 Rondella di protezione multiuso in silicone ; bustina da 5 pezzi.



100 pièces / pieces / Stück / piezas / pezzi

MSA	Ø mm	Épaisseur / Thickness mm	Kg
70.021-060	60 mm	0.06 mm	0.057

Rondelle de protection multi-usage en silicone ; boîte en plastique de 100 pièces.
 Multi-purpose silicon protection washer ; 100-piece plastic box.
 Mehrzweck Silikon-Schutzwasche ; Kunststoffbox mit 100 Stück.
 Arandela de protección multiuso en silicona ; caja de plástico de 100 piezas.
 Rondella di protezione multiuso in silicone ; scatola di plastica da 100 pezzi.



KITS POUR L'ASSEMBLAGE DE MONTRES WATCH ASSEMBLY KITS KITS FÜR UHRENMONTAGE
KITS PARA EL MONTAJE DE RELOJES KIT PER L'ASSEMBLAGGIO DI OROLOGI KITS PARA A MONTAGEM DE RELÓGIOS

Boîtes de montre, cadrans, aiguilles,
mouvements et bracelets en cuir

*Watch cases, dials, hands, movements
and leather straps*

Uhrgehäuse, Zifferblättern, Zeiger,
Werke und Lederarmbänder

*Cajas de reloj, esferas, agujas,
movimientos y correas de cuero*

Casse di orologio, quadranti, lancette,
movimenti e cinturini di cuoio

*Caixas de relógio, mostradores, ponteiros,
movimentos e pulseiras de cuuro*



2

Faites votre montre
Make your watch

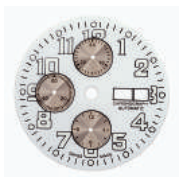

Calibre Valjoux 7750 - SW 500

MSA	Composants/Components	Ø mm	Entre-cornes/Lugs mm	Verre/Crystal	Fond/Back	Bracelets/Straps	Kg
66.011	Boîte titane/Titanium case	41.00	20	Saphir/Sapphire	Verre minéral/ Mineral crystal	Voir/See page 14-5	0.066
66.013	Cadran blanc/White dial	33.50	-	-	-	-	0.003
66.015	Cadran bleu index/Blue index dial	33.50	-	-	-	-	0.003
66.016	Cadran noir/Black dial	33.50	-	-	-	-	0.003
66.017	Jeu d'aiguilles lumineuses/ Set of luminous hands	-	-	-	-	-	-
ETAMP.7750	Mouvement/Movement	-	-	-	-	-	-
SWM.500	Mouvement/Movement	-	-	-	-	-	-

Boîte de montre en titane avec fond transparent, cadrans (blanc, bleu ou noir), aiguilles et mouvements.

Titanium watch case with look through back, dials (white, blue or black), hands and movements.

Titan Uhrgehäuse mit durchsichtigem Boden, Zifferblättern (weiss, blau oder schwarz), Zeiger und Uhrwerke.

Caja de reloj en titanio con fondo transparente, esferas (blanca, azul o negra), agujas y movimientos.

Cassa di orologio in titanio con fondo trasparente, quadranti (bianco, blu o nero), lancette e movimenti.

Caixa de relógio em titânio com fundo transparente, mostradores (branco, azul ou preto), ponteiros e movimentos.



Calibre ETA 2824-2 - SW 200-1

MSA	Composants/Components	Ø mm	Entre-cornes/Lugs mm	Verre/Crystal	Fond/Back	Bracelets/Straps	Kg
66.020	Boîte acier/Steel case	37.00	20	Minéral/Mineral	Verre minéral/ Mineral crystal	Voir/See page 14-5	0.035
66.023	Cadran blanc/White dial	31.50	-	-	-	-	0.003
66.026	Cadran noir/Black dial	31.50	-	-	-	-	0.003
66.027	Jeu d'aiguilles lumineuses/ Set of luminous hands	-	-	-	-	-	-
66.029	Jeu d'aiguilles noires/ Set of black hands	-	-	-	-	-	-
ETAMP.2824-2	Mouvement/Movement	-	-	-	-	-	-
SWM.200-1	Mouvement/Movement	-	-	-	-	-	-

Boîte de montre en acier avec fond transparent, cadrans (blanc ou noir), aiguilles et mouvements.

Steel watch case with look through back, dials (white or black), hands and movements.

Stahl Uhrgehäuse mit durchsichtigem Boden, Zifferblättern (weiss oder schwarz), Zeiger und Uhrwerke.

Caja de reloj en acero con fondo transparente, esferas (blanca o negra), agujas y movimientos.

Cassa di orologio di acciaio con fondo trasparente, quadranti (bianco o nero), lancette e movimenti.

Caixa de relógio em aço com fundo transparente, mostradores (branco ou preto), ponteiros e movimentos.



Calibre Unitas 6497 (seconde à 9H/second at 9H) - Unitas 6498 (seconde à 6H/second at 6H)

MSA	Composants/Components	Ø mm	Entre-cornes/Lugs mm	Verre/Crystal	Fond/Back	Bracelets/Straps	Kg
66.030	Boîte acier/Steel case	48.00	22	Saphir/Sapphire	Verre minéral/Mineral crystal	Voir/See page 14-5	0.047
66.033	Cadran argenté (9H)/Silver dial (9H)	42.50	-	-	-	-	0.003
66.034	Cadran argenté (6H)/Silver dial (6H)	42.50	-	-	-	-	0.003
66.035	Cadran noir (9H)/Black dial (9H)	42.50	-	-	-	-	0.003
66.036	Cadran noir (6H)/Black dial (6H)	42.50	-	-	-	-	0.003
66.038	Jeu d'aiguilles rhodiées/ Set of rhodium-plated hands	-	Hrs. L. 14 mm	Min. L. 19 mm	Sec. L. 5 mm	-	-
66.039	Jeu d'aiguilles noires/ Set of black hands	-	Hrs. L. 14 mm	Min. L. 19 mm	Sec. L. 5 mm	-	-
ETAMP.6497-1	Mouvement/Movement	-	-	-	-	-	-
ETAMP.6498-1	Mouvement/Movement	-	-	-	-	-	-

Boîte de montre en acier (PVD noir) avec fond transparent, cadrans (couleur argent ou noir), aiguilles et mouvements.

Steel watch case (black PVD) with look through back, dials (silver colour or black), hands and movements.

Stahl Uhrgehäuse (schwarzem PVD) mit durchsichtigem Boden, Zifferblättern (Silber-Farbe oder schwarz), Zeiger und Uhrwerke.

Caja de reloj en acero (PVD negro) con fondo transparente, esferas (color plata o negra), agujas y movimientos.

Cassa di orologio di acciaio (PVD nero) con fondo trasparente, quadranti (colore argento o nero), lancette e movimenti.

Caixa de relógio em aço (PVD preto) com fundo transparente, mostradores (cor prata ou preto), ponteiros e movimentos.



Calibre Unitas 6497 (seconde à 9H/second at 9H) - Unitas 6498 (seconde à 6H/second at 6H)

MSA	Composants/Components	Ø mm	Entre-cornes/Lugs mm	Verre/Crystal	Fond/Back	Bracelets/Straps	Kg
66.040	Boîte acier/Steel case	45.00	22	Saphir/Sapphire	Verre minéral/Mineral crystal	Voir/See page 14-5	0.046
66.043	Cadran argenté (9H)/Silver dial (9H)	37.00	-	-	-	-	0.003
66.044	Cadran argenté (6H)/Silver dial (6H)	37.00	-	-	-	-	0.003
66.045	Cadran noir (9H)/Black dial (9H)	37.00	-	-	-	-	0.003
66.046	Cadran noir (6H)/Black dial (6H)	37.00	-	-	-	-	0.003
66.048	Jeu d'aiguilles rhodiées/ Set of rhodium-plated hands	-	Hrs. L. 11 mm	Min. L. 15 mm	Sec. L. 4 mm	-	-
66.049	Jeu d'aiguilles noires/ Set of black hands	-	Hrs. L. 11 mm	Min. L. 15 mm	Sec. L. 4 mm	-	-
ETAMP.6497-1	Mouvement/Movement	-	-	-	-	-	-
ETAMP.6498-1	Mouvement/Movement	-	-	-	-	-	-

Boîte de montre en acier avec fond transparent, cadrans (couleur argent ou noir), aiguilles et mouvements.

Steel watch case with look through back, dials (silver colour or black), hands and movements.

Stahl Uhrgehäuse mit durchsichtigem Boden, Zifferblättern (Silber-Farbe oder schwarz), Zeiger und Uhrwerke.

Caja de reloj en acero con fondo transparente, esferas (color plata o negra), agujas y movimientos.

Cassa di orologio di acciaio con fondo trasparente, quadranti (colore argento o nero), lancette e movimenti.

Caixa de relógio em aço com fundo transparente, mostradores (cor prata ou preto), ponteiros e movimentos.



Calibre ETA 2892-A2 - SW 300-1

MSA	Composants/Components	Ø mm	Entre-cornes/Lugs mm	Verre/Crystal	Fond/Back	Bracelets/Straps	Kg
66.060	Boîte acier/Steel case	41.00	20	Saphir/Sapphire	Verre minéral/ Mineral crystal	Voir/See page 14-5	0.042
66.064	Cadran argenté/Silver dial	34.30	-	-	-	-	0.003
66.066	Cadran noir/Black dial	34.30	-	-	-	-	0.003
66.068	Jeu d'aiguilles rhodiées/ Set of rhodium-plated hands	-	-	-	-	-	-
66.069	Jeu d'aiguilles noires/ Set of black hands	-	-	-	-	-	-
ETAMP.2892-A2	Mouvement/Movement	-	-	-	-	-	-
SWM.300-1	Mouvement/Movement	-	-	-	-	-	-

Boîte de montre en acier avec fond transparent, cadrans (couleur argent ou noir), aiguilles et mouvements.

Steel watch case with look through back, dials (silver colour or black), hands and movements.

Stahl Uhrgehäuse mit durchsichtigem Boden, Zifferblättern (Silber-Farbe oder schwarz), Zeiger und Uhrwerke.

Caja de reloj en acero con fondo transparente, esferas (color plata o negra), agujas y movimientos.

Cassa di orologio di acciaio con fondo trasparente, quadranti (colore argento o nero), lancette e movimenti.

Caixa de relógio em aço com fundo transparente, mostradores (cor prata ou preto), ponteiros e movimentos.



Calibre Valjoux 7750 - SW 500

MSA	Composants/Components	Ø mm	Entre-cornes/Lugs mm	Verre/Crystal	Fond/Back	Bracelets/Straps	Kg
66.070 (1)	Boîte acier/Steel case	45.30	22	Saphir/Sapphire	Verre minéral/ Mineral crystal	Voir/See page 14-5	0.071
66.010 (2)	Boîte acier/Steel case	41.00	20	Minéral/Mineral	Verre minéral/ Mineral crystal	Voir/See page 14-5	0.066
66.073	Cadran blanc/White dial	37.00	-	-	-	-	0.004
66.076	Cadran noir/Black dial	37.00	-	-	-	-	0.004
66.017	Jeu d'aiguilles lumineuses/ Set of luminous hands	-	-	-	-	-	-
ETAMP.7750	Mouvement/Movement	-	-	-	-	-	-
SWM.500	Mouvement/Movement	-	-	-	-	-	-

Boîte de montre en acier avec fond transparent, cadrans (blanc ou noir), aiguilles et mouvements.

Steel watch case with look through back, dials (white or black), hands and movements.

Stahl Uhrgehäuse mit durchsichtigem Boden, Zifferblättern (weiss oder schwarz), Zeiger und Uhrwerke.

Caja de reloj en acero con fondo transparente, esferas (blanca o negra), agujas y movimientos.

Cassa di orologio di acciaio con fondo trasparente, quadranti (bianco o nero), lancette e movimenti.

Caixa de relógio em aço com fundo transparente, mostradores (branco ou preto), ponteiros e movimentos.



MSA	Largeur/Width mm	Couleur/Colour	Kg
66.200	20	Noir/Black	0.015
66.201	20	Bleu/Blue	0.015
66.202	20	Brun/Brown	0.015
66.203	20	Gris/Grey	0.015
66.204	20	Blanc/White	0.015
66.210	22	Noir/Black	0.015
66.211	22	Bleu/Blue	0.015
66.212	22	Brun/Brown	0.015
66.213	22	Gris/Grey	0.015
66.214	22	Blanc/White	0.015

Bracelet en cuir avec fermoir standard ; noir, bleu, brun, gris ou blanc.

Leather strap with standard clasp ; black, blue, brown, grey or white.

Lederarmband mit Standard Schliesse ; schwarz, blau, braun, grau oder weiss.

Correa de cuero con cierre estándar ; negro, azul, castaño, gris o blanco.

Cinturino di cuoio con chiusura standard ; nero, blu, bruno, grigio o bianco.

Pulseira de couro com fecho standard ; preto, azul, castanho, cinzento ou branco.

i **Voir les chapitres complets des BARRETTES et FERMOIRS, pages 2-xx et 10-xx.**
See the complete chapters of SPRING BARS and CLASPS, pages 2-xx and 10-xx.
Siehe die vollständigen Kapiteln der FEDERSTEGE und SCHLIESSEN, Seiten 2-xx und 10-xx.
Ver los capítulos completos de los PASADORES y CIERRES, páginas 2-xx y 10-xx.
Vedere i capitoli completi delle ANSE e CHIUSURE, pagine 2-xx e 10-xx.
Ver os capítulos completos dos PINOS e FECHOS, páginas 2-xx e 10-xx.



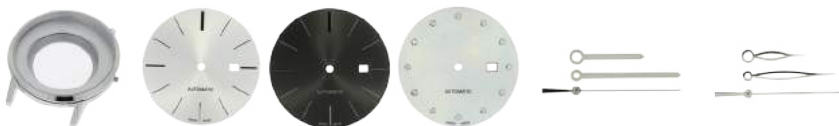

Calibre 2824 - SW 200

MSA	Composants/Components	Ø mm	Entre-cornes/Lugs mm	Verre/Crystal	Fond/Back	Bracelets/Straps	Kg
66.087	Boîte acier/Steel case	40.00	22	Saphir/Sapphire	Verre minéral/ Mineral crystal	Voir/See page 14-10	0.045
66.082	Cadran argenté/Silver dial	37	-	-	-	-	0.004
66.081	Cadran noir/Black dial	37	-	-	-	-	0.004
66.083	Cadran nacré avec pierres/ Mother-of-pearl dial with stones	37	-	-	-	-	0.004
66.084	Jeu d'aiguilles/ Set of hands	-	Hrs. L. 12 mm	Min. L. 17 mm	Sec. L. 17 mm	-	-
66.085	Jeu d'aiguilles feuille/ Set of hands leaf	-	Hrs. L. 10 mm	Min. L. 15 mm	Sec. L. 15 mm	-	-
ETAMP.2824-2	Mouvement/Movement	-	-	-	-	-	-
SWM.200-1	Mouvement/Movement	-	-	-	-	-	-

Boîte de montre en acier avec fond transparent, cadrans (couleur argent, noir ou nacré), aiguilles et mouvements.

Steel watch case with look through back, dials (silver colour, black or mother-of-pearl), hands and movements.

Stahl Uhrgehäuse mit durchsichtigem Boden, Zifferblättern (Silberfarbiger, schwarz oder Perlmutter), Zeiger und Uhrwerke.

Caja de reloj en acero con fondo transparente, esferas (color plata, negra o nacarada), agujas y movimientos.

Cassa di orologio di acciaio con fondo trasparente, quadranti (colore argento, nero o madreperlaceo), lancette e movimenti.

Caixa de relógio em aço com fundo transparente, mostradores (cor prata, preto ou mãe-de-pérola), ponteiros e movimentos.

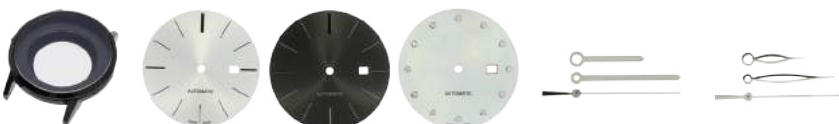

Calibre 2824 - SW 200

MSA	Composants/Components	Ø mm	Entre-cornes/Lugs mm	Verre/Crystal	Fond/Back	Bracelets/Straps	Kg
66.080	Boîte acier/Steel case	40.00	22	Saphir/Sapphire	Verre minéral/ Mineral crystal	Voir/See page 14-10	0.045
66.082	Cadran argenté/Silver dial	37	-	-	-	-	0.004
66.081	Cadran noir/Black dial	37	-	-	-	-	0.004
66.083	Cadran nacré avec pierres/ Mother-of-pearl dial with stones	37	-	-	-	-	0.004
66.084	Jeu d'aiguilles/ Set of hands	-	Hrs. L. 12 mm	Min. L. 17 mm	Sec. L. 17 mm	-	-
66.085	Jeu d'aiguilles feuille/ Set of hands leaf	-	Hrs. L. 10 mm	Min. L. 15 mm	Sec. L. 15 mm	-	-
ETAMP.2824-2	Mouvement/Movement	-	-	-	-	-	-
SWM.200-1	Mouvement/Movement	-	-	-	-	-	-

Boîte de montre en acier (PVD noir) avec fond transparent, cadrans (couleur argent, noir ou nacré), aiguilles et mouvements.

Steel watch case (black PVD) with look through back, dials (silver colour, black or mother-of-pearl), hands and movements.

Stahl Uhrgehäuse (schwarzem PVD) mit durchsichtigem Boden, Zifferblättern (Silberfarbiger, schwarz oder Perlmutter), Zeiger und Uhrwerke.

Caja de reloj en acero (PVD negra) con fondo transparente, esferas (color plata, negra o nacarada), agujas y movimientos.

Cassa di orologio di acciaio (PVD nero) con fondo trasparente, quadranti (colore argento, nero o madreperlaceo), lancette e movimenti.

Caixa de relógio em aço (PVD preto) com fundo transparente, mostradores (cor prata, preto ou mãe-de-pérola), ponteiros e movimentos.

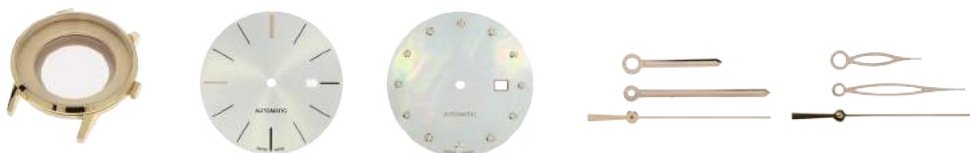

Calibre 2824 - SW 200

MSA	Composants/Components	Ø mm	Entre-cornes/Lugs mm	Verre/Crystal	Fond/Back	Bracelets/Straps	Kg
66.090	Boîte acier/Steel case	40.00	22	Saphir/Sapphire	Verre minéral/ Mineral crystal	Voir/See page 14-10	0.045
66.091	Cadran argenté/Silver dial	37	-	-	-	-	0.004
66.093	Cadran nacré avec pierres 5N/ Mother-of-pearl dial with stones 5N	37	-	-	-	-	0.004
66.094	Jeu d'aiguilles 5N/ Set of hands 5N	-	Hrs. L. 12 mm	Min. L. 17 mm	Sec. L. 17 mm	-	-
66.095	Jeu d'aiguilles feuille 5N/ Set of hands leaf 5N	-	Hrs. L. 10 mm	Min. L. 15 mm	Sec. L. 15 mm	-	-
ETAMP.2824-2	Mouvement/Movement	-	-	-	-	-	-
SWM.200-1	Mouvement/Movement	-	-	-	-	-	-

Boîte de montre en acier (5N) avec fond transparent, cadrans (couleur argent ou nacré), aiguilles et mouvements.

Steel watch case (5N) with look through back, dials (silver colour or mother-of-pearl), hands and movements.

Stahl Uhrgehäuse (5N) mit durchsichtigem Boden, Zifferblättern (Silber-Farbe oder Perlmutter), Zeiger und Uhrwerke.

Caja de reloj en acero (5N) con fondo transparente, esferas (color plata o nacarada), agujas y movimientos.

Cassa di orologio di acciaio (5N) con fondo trasparente, quadranti (colore argento o madreperlaceo), lancette e movimenti.

Caixa de relógio em aço (5N) com fundo transparente, mostradores (cor prata ou mãe-de-pérola), ponteiros e movimentos.



Calibre Valjoux 7750 - SW 500

MSA	Composants/Components	Ø mm	Entre-cornes/Lugs mm	Verre/Crystal	Fond/Back	Bracelets/Straps	Kg
66.108	Boîte acier/Steel case	44.00	22	Saphir/Sapphire	Verre minéral/ Mineral crystal	Voir/See page 14-10	0.095
66.109	Cadran argenté/Silver dial	34.50	-	-	-	-	0.005
66.107	Cadran noir/Black dial	34.50	-	-	-	-	0.005
66.101	Cadran noir (12-6)/ Black dial (12-6)	34.50	-	-	-	-	0.005
66.102	Jeu d'aiguilles noires/ Set of black hands	-	Hrs. L. 10 mm	Min. L. 17 mm	Sec. L. 17 mm	Counters L. 6-4 mm	-
ETAMP.7750	Mouvement/Movement	-	-	-	-	-	-
SWM.500	Mouvement/Movement	-	-	-	-	-	-

Boîte de montre en acier avec réhaut couleur argent et fond transparent, cadrans (couleur argent ou noir), aiguilles et mouvements.

Steel watch case with silver colour flange and look through back, dials (silver colour or black), hands and movements.

Stahl Uhrgehäuse mit Stahlfarbiger Höhenring und durchsichtigem Boden, Zifferblättern (Silber-Farbe oder schwarz), Zeiger und Uhrwerke.

Caja de reloj en acero con realce color plata y fondo transparente, esferas (color plata o negra), agujas y movimientos.

Cassa di orologio di acciaio con incassatura colore argento e fondo trasparente, quadranti (colore argento o nero), lancette e movimenti.

Caixa de relógio em aço com anel rotativo cor prata e fundo transparente, mostradores (cor prata ou preto), ponteiros e movimentos.



Calibre Valjoux 7750 - SW 500

MSA	Composants/Components	Ø mm	Entre-cornes/Lugs mm	Verre/Crystal	Fond/Back	Bracelets/Straps	Kg
66.100	Boîte acier/Steel case	44.00	22	Saphir/Sapphire	Verre minéral/ Mineral crystal	Voir/See page 14-10	0.095
66.109	Cadran argenté/Silver dial	34.50	-	-	-	-	0.005
66.107	Cadran noir/Black dial	34.50	-	-	-	-	0.005
66.101	Cadran noir (12-6)/ Black dial (12-6)	34.50	-	-	-	-	0.005
66.102	Jeu d'aiguilles noires/ Set of black hands	-	Hrs. L. 10 mm	Min. L. 17 mm	Sec. L. 17 mm	Counters L. 6-4 mm	-
ETAMP.7750	Mouvement/Movement	-	-	-	-	-	-
SWM.500	Mouvement/Movement	-	-	-	-	-	-

Boîte de montre en acier avec réhaut noir et fond transparent, cadrans (couleur argent ou noir), aiguilles et mouvements.

Steel watch case with black flange and look through back, dials (silver colour or black), hands and movements.

Stahl Uhrgehäuse mit schwarzer Höhenring und durchsichtigem Boden, Zifferblättern (Silber-Farbe oder schwarz), Zeiger und Uhrwerke.

Caja de reloj en acero con realce negro y fondo transparente, esferas (color plata o negra), agujas y movimientos.

Cassa di orologio di acciaio con incassatura nera e fondo trasparente, quadranti (colore argento o nero), lancette e movimenti.

Caixa de relógio em aço com anel rotativo preto e fundo transparente, mostradores (cor prata ou preto), ponteiros e movimentos.



Calibre Valjoux 7750 - SW 500

MSA	Composants/Components	Ø mm	Entre-cornes/Lugs mm	Verre/Crystal	Fond/Back	Bracelets/Straps	Kg
66.106	Boîte acier/Steel case	44.00	22	Saphir/Sapphire	Verre minéral/ Mineral crystal	Voir/See page 14-10	0.095
66.109	Cadran argenté/Silver dial	34.50	-	-	-	-	0.005
66.107	Cadran noir/Black dial	34.50	-	-	-	-	0.005
66.101	Cadran noir (12-6)/ Black dial (12-6)	34.50	-	-	-	-	0.005
66.102	Jeu d'aiguilles noires/ Set of black hands	-	Hrs. L. 10 mm	Min. L. 17 mm	Sec. L. 17 mm	Counters L. 6-4 mm	-
ETAMP.7750	Mouvement/Movement	-	-	-	-	-	-
SWM.500	Mouvement/Movement	-	-	-	-	-	-

Boîte de montre en acier (PVD noir) avec réhaut noir et fond transparent, cadrans (couleur argent ou noir), aiguilles et mouvements.

Steel watch case (black PVD) with black flange and look through back, dials (silver colour or black), hands and movements.

Stahl Uhrgehäuse (schwarzem PVD) mit schwarzer Höhenring und durchsichtigem Boden, Zifferblättern (Silber-Farbe oder schwarz), Zeiger und Uhrwerke.

Caja de reloj en acero (PVD negro) con realce negro y fondo transparente, esferas (color plata o negra), agujas y movimientos.

Cassa di orologio di acciaio (PVD nero) con incassatura nera e fondo trasparente, quadranti (colore argento o nero), lancette e movimenti.

Caixa de relógio em aço (PVD preto) com anel rotativo preto e fundo transparente, mostradores (cor prata ou preto), ponteiros e movimentos.



Calibre Valjoux 7751

MSA	Composants/Components	Ø mm	Entre-cornes/Lugs mm	Verre/Crystal	Fond/Back	Bracelets/Straps	Kg
66.114	Boîte acier/Steel case	44.00	22	Saphir/Sapphire	Verre minéral/ Mineral crystal	Voir/See page 14-10	0.095
66.113	Cadran argenté/Silver dial	34.50	-	-	-	-	0.005
66.111	Cadran noir/Black dial	34.50	-	-	-	-	0.005
66.112	Jeu d'aiguilles noires/ Set of black hands	-	Hrs. L. 10 mm	Min. L. 17 mm	Sec.+Red L. 17 mm	Counters L. 6-4-3 mm	-
ETAMP.7751	Mouvement/Movement	-	-	-	-	-	-

Boîte de montre en acier avec réhaut couleur argent et fond transparent, cadrans (couleur argent ou noir), aiguilles et mouvements.

Steel watch case with silver colour flange and look through back, dials (silver colour or black), hands and movements.

Stahl Uhrgehäuse mit Stahlfarbiger Höhenring und durchsichtigem Boden, Zifferblättern (Silber-Farbe oder schwarz), Zeiger und Uhrwerke.

Caja de reloj en acero con realce color plata y fondo transparente, esferas (color plata o negra), agujas y movimientos.

Cassa di orologio di acciaio con incassatura colore argento e fondo trasparente, quadranti (colore argento o nero), lancette e movimenti.

Caixa de relógio em aço com anel rotativo cor prata e fundo transparente, mostradores (cor prata ou preto), ponteiros e movimentos.



Calibre Valjoux 7751

MSA	Composants/Components	Ø mm	Entre-cornes/Lugs mm	Verre/Crystal	Fond/Back	Bracelets/Straps	Kg
66.110	Boîte acier/Steel case	44.00	22	Saphir/Sapphire	Verre minéral/ Mineral crystal	Voir/See page 14-10	0.095
66.113	Cadran argenté/Silver dial	34.50	-	-	-	-	0.005
66.111	Cadran noir/Black dial	34.50	-	-	-	-	0.005
66.112	Jeu d'aiguilles noires/ Set of black hands	-	Hrs. L. 10 mm	Min. L. 17 mm	Sec.+Red L. 17 mm	Counters L. 6-4-3 mm	-
ETAMP.7751	Mouvement/Movement	-	-	-	-	-	-

Boîte de montre en acier avec réhaut noir et fond transparent, cadrans (couleur argent ou noir), aiguilles et mouvements.

Steel watch case with black flange and look through back, dials (silver colour or black), hands and movements.

Stahl Uhrgehäuse mit schwarzer Höhenring und durchsichtigem Boden, Zifferblättern (Silber-Farbe oder schwarz), Zeiger und Uhrwerke.

Caja de reloj en acero con realce negro y fondo transparente, esferas (color plata o negra), agujas y movimientos.

Cassa di orologio di acciaio con incassatura nera e fondo trasparente, quadranti (colore argento o nero), lancette e movimenti.

Caixa de relógio em aço com anel rotativo preto e fundo transparente, mostradores (cor prata ou preto), ponteiros e movimentos.



MSA	Largeur/ Width mm	Couleur/Colour	Couture/Sewing	Kg
66.086	22	Noir/Black	Blanche/White	0.015
66.096	22	Brun/Brown	Brun/Brown	0.007
66.103	22	Noir/Black	Noir/Black	0.008
66.104	20	Gris/Grey	Blanche/White	0.012

Bracelet en cuir avec fermoir standard ; noir, brun ou gris.

Leather strap with standard clasp ; black, brown or grey.

Lederarmband mit Standard Schliesse ; schwarz, braun oder grau.

Correa de cuero con cierre estándar ; negro, castaño o gris.

Cinturino di cuoio con chiusura standard ; nero, bruno o grigio.

Pulseira de couro com fecho standard ; preto, castanho ou cinzento.



MSA	Largeur/Width mm	Kg
66.105	22	0.121

Bracelet en métal.

Metal bracelet.

Armband aus Metall.

Pulseira en metal.

Braccialeto in metallo.

Bracelete de metal.



PENDULERIE
PENDULERÍA

CLOCK PARTS
PENDOLERIA

PENDELUHR
PÊNDULARIA

Clés pour pendules
Clock keys
Schlüssel für Pendeluhr
Llaves para péndulos
Chiavi per pendoli
Chaves para pêndulos



2

Suspensions pour pendules
Pendulum suspensions
Pendelfedern
Suspensiones para péndulos
Sospensioni per pendoli
Suspensões para pêndulos



6

Clés pour montres de poche
Pocket watches keys
Schlüssel für Taschenuhren
Llaves para relojes de bolsillo
Chiavi per orologi da tasca
Chaves para relógios de bolso



3

Suspensions pour pendules 400 jours
Suspensions for 400-day-clocks
Pendelfedern für Jahruhrpendel
Suspensiones para péndulos 400 días
Sospensioni per pendoli 400 giorni
Suspensões para pêndulos 400 dias

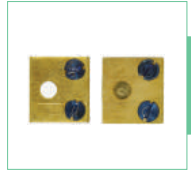

11

Goupilles coniques
Conical pins
Konische Stifte
Grupillas cónicas
Copiglie coniche
Cavilhas cônicas



4

Chiffres pour pendules
Pendulum numerals
Pendelziffern
Números para péndulos
Numeri per pendoli
Números para pêndulos



13

Gouttes et rondelles
Hand-collets and washers
Scheibchen
Gotas y arandelas
Gocce e rondelle
Gotas e rodela



5



Clé pour pendules.
Clock key.
 Schlüssel für Pendeluhren.
Llave para péndulos.
 Chiave per pendoli.
Chave para pêndulos.

PERF	N°/No.	mm	Kg
44.000	0000	1.50	0.008
44.001	000	1.75	0.008
44.002	00	2.00	0.008
44.003	0	2.25	0.008
44.004	1	2.50	0.008
44.005	2	2.75	0.008
44.006	3	3.00	0.008

PERF	N°/No.	mm	Kg
44.007	4	3.25	0.015
44.008	5	3.50	0.015
44.009	6	3.75	0.016
44.010	7	4.00	0.020
44.011	8	4.25	0.020
44.012	9	4.50	0.020
44.013	10	4.75	0.024

PERF	N°/No.	mm	Kg
44.014	11	5.00	0.024
44.015	12	5.25	0.025
44.016	13	5.50	0.031
44.017	14	5.75	0.031
44.018	15	6.00	0.031

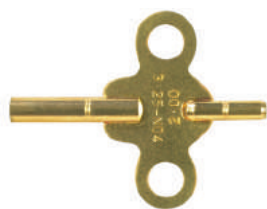

Clé double pour pendules.
Clock double key.
 Doppelschlüssel für Pendeluhren.
Llave doble para péndulos.
 Chiave doppia per pendoli.
Chave dupla para pêndulos.

PERF	mm	Kg
44.020	1.75-2.00	0.012
44.021	1.75-2.25	0.013
44.022	1.75-2.50	0.013
44.023	2.50-2.00	0.013
44.024	2.75-2.00	0.013
44.025	3.00-1.95	0.020

PERF	mm	Kg
44.026	3.25-2.00	0.016
44.027	3.50-2.00	0.016
44.028	3.75-2.00	0.015
44.029	4.00-2.00	0.015
44.030	4.25-2.00	0.017
44.031	4.50-2.00	0.018

PERF	mm	Kg
44.032	4.75-2.00	0.019
44.033	5.00-2.00	0.019
44.034	5.25-2.00	0.019
44.035	5.50-2.00	0.022
44.036	5.75-2.00	0.022



Clé à 5 branches pour pendules.
Five arm clock key.
 Schlüssel mit 5 Arme für Pendeluhren.
Llave a 5 brazos para péndulos.
 Chiave a 5 braccia per pendoli.
Chave de 5 braços para pêndulos.

PERF	N°/No.	mm	Kg
44.050	2-4-6-8-10	2.75-3.25-3.75-4.25-4.75	0.048
44.051	3-5-7-9-11	3.00-3.50-4.00-4.50-5.00	0.052
44.052	4-6-8-10-12	3.25-3.75-4.25-4.75-5.25	0.052



Clé pour pendules ; laiton.

Clock key ; brass.

Schlüssel für Pendeluhrn ; Messing.

Llave para péndulos ; latón.

Chiave per pendoli ; ottone.

Chave para pêndulos ; latão.

PERF	N°/No.	mm	Kg
44.090	5	3.50	0.006
44.091	6	3.75	0.006
44.092	7	4.00	0.006
44.093	8	4.25	0.006
44.094	9	4.50	0.006

PERF	N°/No.	mm	Kg
44.095	10	4.75	0.006
44.096	11	5.00	0.006
44.097	12	5.25	0.006
44.098	13	5.50	0.006
44.099	14	5.75	0.006

PERF	N°/No.	mm	Kg
44.100	15	6.00	0.006
44.101	16	6.25	0.006
44.102	17	6.50	0.006
44.103	18	6.75	0.006
44.104	19	7.00	0.006



Clé à 5 branches pour montres de poche ; laiton.

Five arm pocket watches key ; brass.

Schlüssel mit 5 Arme für Taschenuhren ; Messing.

Llave a 5 brazos para relojes de bolsillo ; latón.

Chiave a 5 braccia per orologi da tasca ; ottone.

Chave de 5 braços para relógios de bolso ; latão.

PERF	N°/No.	mm	Kg
44.250	3-5-7-9-11	1.65-1.50-1.30-1.15-1.00	0.012
44.251	2-4-6-8-10	1.75-1.60-1.40-1.20-1.05	0.012



Clé pour montres de poche, branche carrée ; acier trempé.

Pocket watches key, square arm ; tempered steel.

Schlüssel für Taschenuhren, viereckiger Arm ; gehärtet Edelstahl.

Llave para relojes de bolsillo, brazo cuadrado ; acero templado.

Chiave per orologi da tasca, braccio quadrato ; acciaio temperato.

Chave para relógios de bolso, braço quadrado ; aço temperado.

PERF	N°/No.	mm	Kg
44.200	00	2.00	0.002
44.201	0	1.90	0.002
44.202	1	1.80	0.002
44.203	2	1.75	0.002
44.204	3	1.65	0.002

PERF	N°/No.	mm	Kg
44.205	4	1.60	0.002
44.206	5	1.50	0.002
44.207	6	1.40	0.002
44.208	7	1.30	0.002
44.209	8	1.20	0.002

PERF	N°/No.	mm	Kg
44.210	9	1.15	0.002
44.211	10	1.05	0.002
44.212	11	1.00	0.002
44.213	12	0.95	0.002



Assortiment de goupilles coniques; laiton.
 Assortment of conical pins; brass.
 Sortiment von konische Stifte; Messing.
 Surtido de grupillas cónicas; latón.
 Assortimento di copiglie coniche; ottone.
 Sortido de cavilhas cônicas; latão.

PERF	Qt.	Kg
48.000	100x	0.027



Assortiment de goupilles coniques; acier.
 Assortment of conical pins; steel.
 Sortiment von konische Stifte; Stahl.
 Surtido de grupillas cónicas; acero.
 Assortimento di copiglie coniche; acciaio.
 Sortido de cavilhas cônicas; aço.

PERF	Qt.	Kg
48.001	100x	0.026



Assortiment de gouttes; laiton.
 Assortment of hand-collets; brass.
 Sortiment von Scheibchen; Messing.
 Surtido de gotas; latón.
 Assortimento di gocce; ottone.
 Sortido de gotas; latão.

PERF	Qt.	Kg
48.100	144x	0.031



Assortiment de gouttes; acier.
 Assortment of hand-collets; steel.
 Sortiment von Scheibchen; Stahl.
 Surtido de gotas; acero.
 Assortimento di gocce; acciaio.
 Sortido de gotas; aço.

PERF	Qt.	Kg
48.101	144x	0.031



Assortiment de rondelles; acier.
 Assortment of washers; steel.
 Sortiment von Scheiben; Stahl.
 Surtido de arandelas; acero.
 Assortimento di rondelle; acciaio.
 Sortido de rodelas; aço.

PERF	Qt.	Kg
48.200	144x	0.035

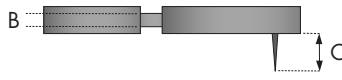
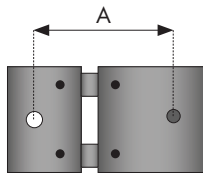









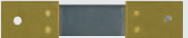

Suspension métallique pour pendule.
 Metallic pendulum suspension.
 Metallpendelfeder.
 Suspensión metálica para péndulo.
 Sospensione metallica per pendolo.
 Suspensão metálica para pêndulo.

MSA	1/1	N°/No.	A x B x C mm	Kg
55.018		18	- x 0.10 x -	0.001
55.054-S		54 S	9.00 x 0.04 x 5.50	0.003
55.001		1	10.50 x 0.04 x 6.80	0.001
55.035		35	10.50 x 0.04 x 6.80	0.001
55.009		9	10.50 x 0.05 x 6.80	0.001
55.019		19	10.50 x 0.06 x 6.80	0.001
55.002		2	11.50 x 0.04 x 6.80	0.001
55.024		24	11.50 x 0.05 x -	0.001
55.037		37	12.00 x 0.04 x 6.80	0.001
55.300		300	12.50 x 0.04 x 6.80	0.001
55.016		16	12.50 x 0.05 x -	0.001
55.023		23	12.50 x 0.05 x -	0.001
55.003		3	12.50 x 0.05 x 6.80	0.001
55.010		10	12.50 x 0.05 x 6.80	0.001

MSA	1/1	N°/No.	A x B x C mm	Kg
55.036		36	12.50 x 0.05 x 6.80	0.001
55.038		38	12.50 x 0.05 x 6.80	0.001
55.307		307	12.50 x 0.05 x 6.80	0.001
55.017		17	13.00 x 0.04 x 6.80	0.001
55.202		202	13.00 x 0.04 x 6.80	0.001
55.020		20	13.00 x 0.06 x 6.80	0.001
55.008		8	13.50 x 0.04 x 6.80	0.001
55.004		4	13.50 x 0.05 x 6.80	0.001
55.022		22	14.00 x 0.05 x -	0.001
55.005		5	14.50 x 0.05 x 6.80	0.001
55.015		15	14.50 x 0.05 x 6.80	0.001
55.130		130	14.50 x 0.05 x 6.80	0.008
55.014		14	15.00 x 0.05 x 6.80	0.001
55.201		201	15.00 x 0.05 x 6.80	0.001
55.026		26	15.50 x 0.05 x -	0.001
55.006		6	15.50 x 0.06 x 6.80	0.001
55.048		48	15.50 x 0.06 x 7.80	0.003



MSA	1/1	N°/No.	A x B x C mm	Kg
55.303		303	15.50 x 0.07 x 7.80	0.001
55.304		304	15.50 x 0.10 x 7.80	0.001
55.128		128	16.00 x 0.05 x 6.80	0.001
55.021		21	16.00 x 0.06 x 6.80	0.001
55.311		311	16.50 x 0.05 x 6.80	0.008
55.007		7	16.50 x 0.06 x 6.80	0.001
55.012		12	17.00 x 0.05 x 6.80	0.001
55.039		39	17.00 x 0.05 x 6.80	0.001
55.025		25	17.00 x 0.05 x -	0.001
55.027		27	17.50 x 0.04 x 6.80	0.001
55.301		301	17.50 x 0.06 x 8.00	0.001
55.132		132	18.00 x 0.05 x 6.80	0.001
55.045		45	18.00 x 0.06 x 7.80	0.002
55.047		47	18.00 x 0.06 x 7.80	0.002
55.308		308	18.00 x 0.10 x -	0.001
55.028		28	18.50 x 0.05 x 6.80	0.001

MSA	1/1	N°/No.	A x B x C mm	Kg
55.131		131	18.50 x 0.06 x 6.80	0.008
55.013		13	19.00 x 0.05 x 6.80	0.001
55.102		102	19.00 x 0.50	0.001
55.029		29	19.50 x 0.05 x 6.80	0.001
55.046		46	19.50 x 0.06 x 7.80	0.002
55.049		49	19.50 x 0.06 x 7.80	0.001
55.312		312	20.00 x 0.06 x 6.80	0.008
55.043		43	20.00 x 0.07 x 7.80	0.001
55.041		41	20.50 x 0.07 x 7.80	0.003
55.042		42	20.50 x 0.07 x 7.80	0.002
55.313		313	23.00 x 0.07 x 6.80	0.008
55.040		40	26.00 x 0.07 x 6.80	0.003

Suspension en plastique pour pendule.
 Plastic pendulum suspension.

Kunststoffpendelfeder.
 Suspensión de plástico para péndulo.

Sospensione in plastica per pendolo.
 Suspensão de plástico para pêndulo.

MSA	1/1	N°/No.	A x B x C mm	Kg
55.295		295	19.00 x 0.10 x -	0.001
55.296		296	32.00 x 0.10 x -	0.001

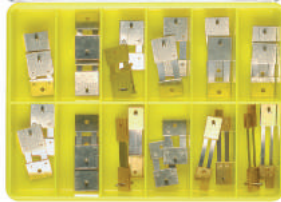
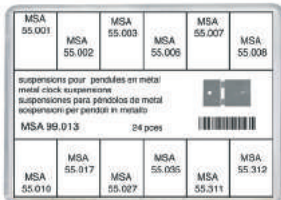

Assortiment de suspensions en métal pour pendule.

Assortment of pendulum metal suspensions.

Sortiment von metallische Pendelfedern.

Surtido de suspensiones en metal para péndulo.

Assortimento di sospensioni di metallo per pendolo.

Sortido de suspensões em metal para pêndulo.

Contenu - Contents - Inhalt - Contenido - Contenuto - Conteúdo :
12 modèles - models - Modelle - modelos - modelli - modelos
2x MSA55.001 /.002 /.003 /.006 /.007 /.008 /.010 /.017 /.027
/.035 /.311 /.312

MSA	Qt.	Kg
99.013	24x	0.057



Assortiment de suspensions en métal pour pendule.

Assortment of pendulum metal suspensions.

Sortiment von metallische Pendelfedern.

Surtido de suspensiones en metal para péndulo.

Assortimento di sospensioni di metallo per pendolo.

Sortido de suspensões em metal para pêndulo.

Contenu - Contents - Inhalt - Contenido - Contenuto - Conteúdo :
12 modèles - models - Modelle - modelos - modelli - modelos
3x MSA55.001 /.002 /.003 /.006 /.007 /.008 /.010 /.017 /.027
/.035 /.311 /.312

MSA	Qt.	Kg
99.014	36x	0.067

MSA	N°/No.	A x B mm	C mm	Description	Kg
55.901	1	7.40 x 8.10	-	Dessus/Upper part Gr. 1	0.001
55.902	2	7.40 x 8.10	Ø 1.00 x 7.85	Dessous/Bottom part Gr. 1	0.001
55.903	3	6.00 x 8.00	-	Dessus/Upper part Gr. 2	0.001
55.904	4	6.00 x 8.00	Ø 1.00 x 7.85	Dessous/Bottom part Gr. 2	0.001
55.905	5	5.15 x 5.90	-	Dessus/Upper part Gr. 3	0.001
55.906	6	5.15 x 5.90	Ø 1.00 x 6.00	Dessous/Bottom part Gr. 3	0.001
55.907	7	-	-	Jeu/Set MSA55.901+MSA55.902	0.002
55.908	8	-	-	Jeu/Set MSA55.903+MSA55.904	0.002
55.909	9	-	-	Jeu/Set MSA55.905+MSA55.906	0.002

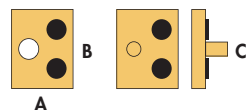

Plaque supérieure et inférieure pour pendule 400 jours.

Upper and bottom fitting for 400-day-clock.

Ober- und Unterbeschlag für Jahresuhrpendel.

Placa superior e inferior para pêndulo 400 dias.

Lastra superiore e inferiore per pendolo 400 giorni.

Placa superior e inferior para pêndulo 400 dias.



Assortiment de plaques supérieures et inférieures pour pendule 400 jours.

Assortment of upper and bottom fittings for 400-day-clock.

Sortiment von Ober- und Unterbeschläge für Jahresuhrpendel.

Surtido de placas superiores e inferiores para pêndulo 400 dias.

Assortimento di lastre superiori e inferiori per pendolo 400 giorni.

Sortido de placas superiores e inferiores para pêndulo 400 dias.

MSA	Qt.	Kg
55.921	6x	0.020

**Contenu - Contents - Inhalt - Contenido - Contenuto - Conteúdo :
 6 modèles - models - Modelle - modelos - modelli - modelos
 1x MSA55.901 /.902 /.903 /.904 /.905 /.906**

MSA	N°/No.	A x B x C mm	Kg
55.910	EH	3.00 x 5.70 x 12.20	0.001
55.911	EK	3.00 x 5.70 x 8.80	0.001
55.912	EN	3.00 x 5.70 x 14.00	0.001
55.913	G1	4.00 x 5.70 x 16.50	0.001
55.914	G2	4.00 x 5.90 x 14.00	0.001
55.915	MK	3.65 x 5.70 x 13.60	0.001

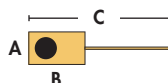

Entraîneur pour pendule 400 jours.

Actuator for 400-day-clock.

Mitnehmer für Jahresuhrpendel.

Arrastre para pêndulo 400 dias.

Conduttore per pendolo 400 giorni.

Arrastador para pêndulo 400 dias.



Assortiment d'entraîneurs pour pendule 400 jours.

Assortment of actuators for 400-day-clock.

Sortiment von Mitnehmern für Jahresuhrpendel.

Surtido de arrastres para pêndulo 400 dias.

Assortimento di conduttori per pendolo 400 giorni.

Sortido de arrastadores para pêndulo 400 dias.

MSA	Qt.	Kg
55.920	6x	0.020

**Contenu - Contents - Inhalt - Contenido - Contenuto - Conteúdo :
 6 modèles - models - Modelle - modelos - modelli - modelos
 1x MSA55.910 /.911 /.912 /.913 /.914 /.915**

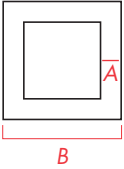

MSA	N°/No.	A x B x C mm	Kg
55.930	04	0.050 x 0.60 x 160	0.001
55.931	06	0.060 x 0.60 x 160	0.001
55.932	07	0.066 x 0.60 x 160	0.001
55.933	08	0.070 x 0.60 x 160	0.001
55.934	09	0.075 x 0.60 x 160	0.001
55.935	10	0.080 x 0.60 x 160	0.001
55.936	11	0.085 x 0.60 x 160	0.001
55.937	12	0.090 x 0.60 x 160	0.001
55.938	13	0.095 x 0.60 x 160	0.001
55.939	14	0.100 x 0.60 x 160	0.001

A : Epaisseur - Thickness - Dicke - Grosor - Spessore - Espessura.
 B : Largeur - Width - Breite - Anchura - Larghezza - Largura.
 C : Longueur - Length - Länge - Longitud - Lunghezza - Comprimento.

Fil de suspension pour pendule 400 jours, forme carrée.
 Suspension spring wire for 400-day-clock, square shape.
 Drehpendelfederndraht für Jahresuhrpendel, viereckige Form.
 Hilo de suspensión para péndulo 400 días, forma cuadrada.
 Filo di sospensione per pendolo 400 giorni, forma quadrata.
 Fio de suspensão para pêndulo 400 dias, forma quadrada.



Assortiment de fils de suspension pour pendule 400 jours.
 Assortment of suspension spring wires for 400-day-clock.
 Sortiment von Drehpendelfederndrähte für Jahresuhrpendel.
 Surtido de hilos de suspensión para péndulo 400 días.
 Assortimento di fili di sospensione per pendolo 400 giorni.
 Sortido de fios de suspensão para pêndulo 400 dias.

**Contenu - Contents - Inhalt - Contenido - Contenuto - Conteúdo :
 10 modèles - models - Modelle - modelos - modelli - modelos
 1x MSA55.930 /.931 /.932 /.933 /.934 /.935 /.936 /.937 /.938
 /.939**

MSA	Qt.	Kg
55.940	10x	0.015



MSA	Hauteur/Height	Kg
55.601	10 mm / 3/8"	0.002
55.602	13 mm / 1/2"	0.004
55.603	16 mm / 5/8"	0.006
55.604	21 mm / 13/16"	0.006
55.605	25 mm / 1"	0.009

Chiffres autocollants pour pendule ; 1 à 12.

Self-adhesive pendulum numerals ; 1 to 12.

Aufklebende Pendelziffern ; 1 bis 12.

Números autoadhesivos para péndulo ; 1 hasta 12.

Numeri autoadesivi per pendolo ; 1 a 12.

Números autocolantes para pêndulo ; 1 a 12.

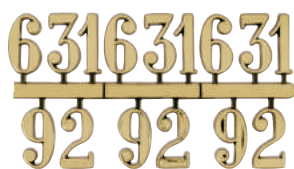

MSA	Hauteur/Height	Kg
55.611	10 mm / 3/8"	0.003
55.612	13 mm / 1/2"	0.003
55.613	16 mm / 5/8"	0.005
55.614	21 mm / 13/16"	0.007
55.615	25 mm / 1"	0.008

Chiffres autocollants pour pendule ; 3, 6, 9 et 12.

Self-adhesive pendulum numerals ; 3, 6, 9 and 12.

Aufklebende Pendelziffern ; 3, 6, 9 und 12.

Números autoadhesivos para péndulo ; 3, 6, 9 y 12.

Numeri autoadesivi per pendolo ; 3, 6, 9 e 12.

Números autocolantes para pêndulo ; 3, 6, 9 e 12.



MSA	Hauteur/Height	Kg
55.621	16 mm / 5/8"	0.003
55.622	19 mm / 3/4"	0.004
55.623	25 mm / 1"	0.005

Chiffres autocollants pour pendule ; 3, 6, 9, 12 et index.

Self-adhesive pendulum numerals ; 3, 6, 9, 12 and indexes.

Aufklebende Pendelziffern ; 3, 6, 9, 12 und Indexzeichen.

Números autoadhesivos para péndulo ; 3, 6, 9, 12 y índices.

Numeri autoadesivi per pendolo ; 3, 6, 9, 12 e indici.

Números autocolantes para pêndulo ; 3, 6, 9, 12 e índices.



MSA	Hauteur/Height	Kg
55.631	16 mm / 5/8"	0.003
55.632	19 mm / 3/4"	0.004
55.633	25 mm / 1"	0.007

Chiffres autocollants pour pendule ; 3, 6, 9, 12 et index.
Self-adhesive pendulum numerals ; 3, 6, 9, 12 and indexes.
 Aufklebende Pendelziffern ; 3, 6, 9, 12 und Indexzeichen.
Números autoadhesivos para péndulo ; 3, 6, 9, 12 y índices.
 Numeri autoadesivi per pendolo ; 3, 6, 9, 12 e indici.
Números autocolantes para pêndulo ; 3, 6, 9, 12 e índices.



MSA	Hauteur/Height	Kg
55.651	10 mm / 3/8"	0.002
55.652	13 mm / 1/2"	0.004
55.653	16 mm / 5/8"	0.005
55.654	21 mm / 13/16"	0.008
55.655	25 mm / 1"	0.010

Chiffres autocollants pour pendule ; I à XII.
Self-adhesive pendulum numerals ; I to XII.
 Aufklebende Pendelziffern ; I bis XII.
Números autoadhesivos para péndulo ; I hasta XII.
 Numeri autoadesivi per pendolo ; I a XII.
Números autocolantes para pêndulo ; I a XII.



MSA	Hauteur/Height	Kg
55.661	10 mm / 3/8"	0.002
55.662	13 mm / 1/2"	0.004
55.663	16 mm / 5/8"	0.004
55.664	21 mm / 13/16"	0.007
55.665	25 mm / 1"	0.014

Chiffres autocollants pour pendule ; III, VI, IX et XII.
Self-adhesive pendulum numerals ; III, VI, IX and XII.
 Aufklebende Pendelziffern ; III, VI, IX und XII.
Números autoadhesivos para péndulo ; III, VI, IX y XII.
 Numeri autoadesivi per pendolo ; III, VI, IX e XII.
Números autocolantes para pêndulo ; III, VI, IX e XII.

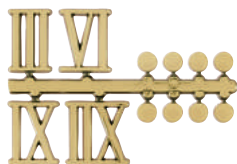

Chiffres autocollants pour pendule ; III, VI, IX, XII et index.
 Self-adhesive pendulum numerals ; III, VI, IX, XII and indexes.

MSA	Hauteur/Height	Kg
55.671	16 mm / 5/8"	0.004
55.672	19 mm / 3/4"	0.004
55.673	25 mm / 1"	0.006

Aufklebende Pendelziffern ; III, VI, IX, XII und Indexzeichen.
 Números autoadhesivos para péndulo ; III, VI, IX, XII y índices.
 Numeri autoadesivi per pendolo ; III, VI, IX, XII e indici.
 Números autocolantes para pêndulo ; III, VI, IX, XII e índices.

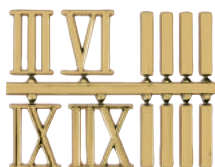

Chiffres autocollants pour pendule ; III, VI, IX, XII et index.
 Self-adhesive pendulum numerals ; III, VI, IX, XII and indices.

MSA	Hauteur/Height	Kg
55.681	16 mm / 5/8"	0.004
55.682	19 mm / 3/4"	0.005
55.683	25 mm / 1"	0.007

Selbstklebende Pendelziffern ; III, VI, IX, XII und Indexzeichen.
 Números autoadhesivos para péndulo ; III, VI, IX, XII y índices.
 Numeri autoadesivi per pendolo ; III, VI, IX, XII e indici.
 Números autocolantes para pêndulo ; III, VI, IX, XII e índices.

A series of horizontal dotted lines for writing notes, spanning the width of the page.

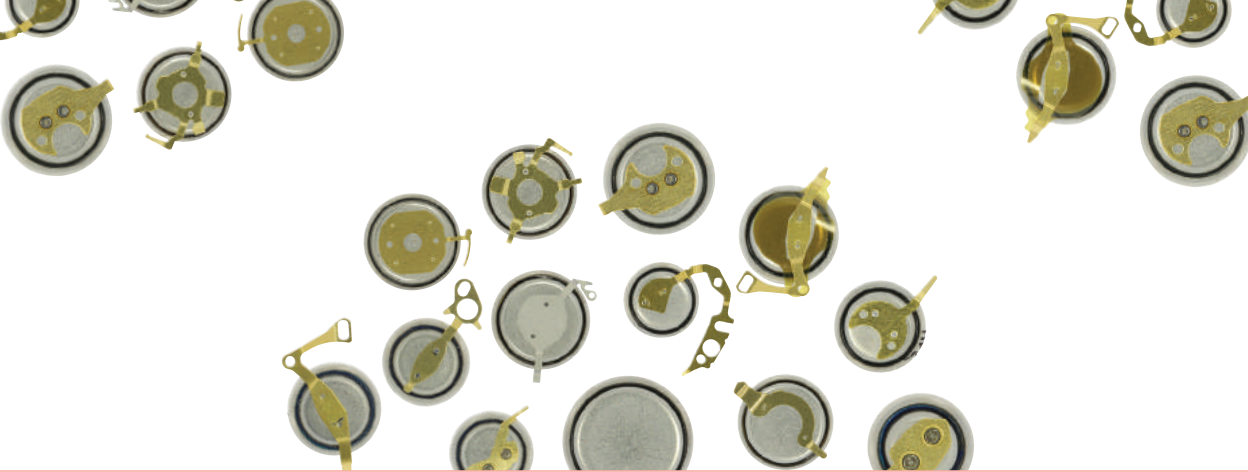

PILES BATTERIES BATTERIEN
 BATERÍAS BATTERIE PILHAS

Piles

Batteries

Batterien

Baterías

Batterie

Pilhas



2

Adaptateurs de pile

Battery adapters

Batterieadapter

Adaptadores de batería

Adattatori per batterie

Adaptadores de pilha



5

Accumulateurs

Capacitors

Akkumulatoren

Acumuladores

Accumulatori

Acumuladores



6

Assortiments de brides de fixation de pile

Assortments of battery clamps

Sortimente von Batteriehalterfedern

Surtidos de bridas de fijación de batería

Assortimenti di bride di fissaggio della batteria

Sortidos de bridas de fixação de pilha



10



Pile type bouton Energizer® 0% mercure.
Energizer® button type battery 0% mercury.
Energizer® Knopf-Typ Batterie 0% Quecksilber.
Batería tipo botón Energizer® 0% mercurio.
Batteria tipo bottone Energizer® 0% mercurio.
Pilha tipo botão Energizer® 0% mercúrio.

Réf./Item	N°/Nr.
PILE301	301/386
PILE303	303/357
PILE309	→ PILE393
PILE314	314/315
PILE317	317
PILE319	319
PILE321	321
PILE329	329
PILE335	335
PILE337	337
PILE341	341
PILE344	344/350
PILE346	346
PILE350	→ PILE344

Réf./Item	N°/Nr.
PILE357	→ PILE303
PILE361	→ PILE362
PILE362	362/361
PILE363	→ PILE364
PILE364	364/363
PILE365	365/366
PILE366	→ PILE365
PILE370	→ PILE371
PILE371	371/370
PILE373	373
PILE376	→ PILE377
PILE377	377/376
PILE379	379
PILE380	→ PILE394

Réf./Item	N°/Nr.
PILE384	→ PILE392
PILE386	→ PILE301
PILE389	389/390
PILE390	→ PILE389
PILE391	391/381
PILE392	392/384
PILE393	393/309
PILE394	394/380
PILE395	395/399
PILE396	396/397
PILE399	→ PILE395



i Horotec SA est le représentant exclusif Energizer® pour l'industrie horlogère suisse.

Horotec SA ist der Energizer® Exklusivvertreter für die Schweizer Uhrindustrie.

Horotec SA è il rappresentante esclusivo Energizer® per l'industria orologiera svizzera.

Pile type bouton Energizer® 0% mercure.
Energizer® Knopf-Typ Batterie 0% Quecksilber.
Batteria tipo bottone Energizer® 0% mercurio.

Réf./Item	N°/Nr.
PILE317VPO	317
PILE321VPO	321
PILE335VPO	335
PILE341VPO	341

Réf./Item	N°/Nr.
PILE362/361VPO	362/361
PILE364/363VPO	364/363
PILE371/370VPO	371/370
PILE377/376VPO	377/376

Réf./Item	N°/Nr.
PILE379VPO	379
PILE394/380VPO	394/380
PILE395/399VPO	395/399
PILE397/396VPO	397/396

Livraison sur plateau (commande minimum : 500 pièces par référence).

Lieferung auf Platte (Mindestauftrag : 500 Stück per Referenz).

Consegna su piattello (Ordine minimo : 500 pezzi per referenza).



Pile lithium Energizer®.
Energizer® lithium battery.
Energizer® Lithium-Batterie.
Batería de litio Energizer®.
Batteria di litio Energizer®.
Pilha de lítio Energizer®.

Réf./Item	N°/Nr.
PILEBR1225	BR1225
PILEBR2325***	BR2325
PILECR1025	CR1025
PILECR1216	CR1216
PILECR1220	CR1220

Réf./Item	N°/Nr.
PILECR1616	CR1616
PILECR1620	CR1620
PILECR1632	CR1632
PILECR2	CR2
PILECR2-12*	CR2, FSB-2

Réf./Item	N°/Nr.
PILECR2025***	CR2025
PILECR2032-2*	CR2032
PILECR2320**	CR2320
PILECR2430-2*	CR2430
PILECR2450-2*	CR2450

* Blister 2 pces

** Renata

*** Jusqu'à épuisement des stocks / Will be discontinued after end of stock / Solange Vorrat / Hasta agotamiento del stock
Fino ad esaurimento dello stock / Até esgotamento do stock



Pile lithium Leclanché®.
Leclanché® lithium battery.
Leclanché® Lithium-Batterie.
Batería de litio Leclanché®.
Batteria di litio Leclanché®.
Pilha de lítio Leclanché®.

Réf./Item	N°/Nr.
PILELS14250	LS14250 - 3.6 V
PILELS14500	LS14500 - 3.6 V
PILELS33600	LS33600 - 3.6 V



Pile Energizer®.
Energizer® battery.
Energizer® Batterie.
Batería Energizer®.
Batteria Energizer®.
Pilha Energizer®.

Réf./Item	N°/Nr.	Emballage/Packaging
PILE10	AC10E/10/PR70	Blister 8 pcs
PILE123	123/CR17345	Blister 1 pce
PILE13	AC13E/13/PR48	Blister 8 pcs
PILE312	AC312E/312/PR41	Blister 8 pcs
PILE6LR61VRAC12	6LR61/6AM6	Vrac/Bulk 12 pcs
PILEA23	A23/E23A	Blister 1 pce
PILEA27/2	A27	Blister 2 pcs
PILEA544	A544/4LR44	Blister 2 pcs
PILEE11A	E11A/A11	Blister 1 pce
PILEEPX625	EPX625G/LR9	Blister 1 pce
PILEEPX76	EPX76/SR44	Blister 2 pcs
PILEER3S1/2AA*	ER3S 1/2 AA	-
PILEHR03	AAA HR03 850	Blister 2 pcs
PILEHR14	HR14	Blister 2 pcs
PILEHR6	AA HR6 2450	Blister 4 pcs
PILELR91	AA/L91/FR6	Blister 2 pcs
PILELR92	AAA/L92/FR03	Blister 2 pcs
PILELR03	AAA/LR03	Blister 4 pcs
PILELR03VP	AAA/LR03	Carton 615 pcs

* Leclanché

Réf./Item	N°/Nr.	Emballage/Packaging
PILELR03VRAC10	AAA LR03/AM4	Vrac/Bulk 10 pcs
PILELR1	LR1/E90	Blister 1 pce
PILELR14	LR14	Blister 2 pcs
PILELR14VRAC12	LR14/AM2	Vrac/Bulk 12 pcs
PILELR1VRAC576	LR1	Vrac/Bulk 576 pcs
PILELR20	LR20	Blister 2 pcs
PILELR20VRAC12	LR20/AM1	Vrac/Bulk 12 pcs
PILELR43	LR43/186	Blister 2 pcs
PILELR44	LR44/A76	Blister 2 pcs
PILELR54	LR54/189	Blister 2 pcs
PILELR6	LR6	Blister 4 pcs
PILELR61	AAAA/LR61/AM5/E96	Blister 2 pcs
PILELR6VP	AA/LR6/AM3	Carton 325 pcs
PILELR6VRAC10	AA LR6/AM3	Vrac/Bulk 10 pcs



Adaptateur de pile pour réveil Cartier (pile EPX625G).
 Battery adapter for alarm clock Cartier (battery EPX625G).
 Batterieadapter für Cartier-Wecker (Batterie EPX625G).
 Adaptador de batería para despertador Cartier (Batería EPX625G).
 Adattatore per batteria per sveglia Cartier (batteria EPX625G).
 Adaptador de pilha para despertador Cartier (pilha EPX625G).

Réf./Item no.	Dimensions/Size mm	Kg
PIL.001	Ø 16.00 x 10.80	0.007











Adaptateur en POM pour pile 388, remplacée par la pile 329.
 Adapter made of POM for battery 388, replaced by the battery 329.
 Adapter aus POM für Batterie 388, ersetzt bei der Batterie 329.
 Adaptador en POM para batería 388, sustituida por la batería 329.
 Adattatore in POM per batteria 388, sostituita dalla batteria 329.
 Adaptador em POM para pilha 388, substituída pela pilha 329.

Réf./Item	Ø ext. x Ø int. mm	Epaisseur/Thickness mm	Kg
PIL.002	8.50 x 7.60	2.25	0.001



Accumulateur Seiko®.
 Seiko® capacitor.
 Seiko® Akkumulator.
 Acumulador Seiko®.
 Accumulatore Seiko®.
 Acumulador Seiko®.

Réf./Item	Pile/Battery	Calibres
S302265U		CTL920 S760A
S302324L		MT920 5D22 - 5D44
S302324M		MT920 7B22 - 7B24 - 7B25 - 7B26 - 7B32 - 7B37 - 7B42 7B52
S302324P		MT920 V121 - V122
S302324R		MT920 7M12A - 7M22A - 7M42A
S302324T		MT920 7L22 - YT57B
S302324X		MT920 5J21A - 5J22A - 5J23A - 5J32
S302324Y		MT920 5K22A - 5K25A - 5K2JA - V142A - V145A - V14JA VS32
S302334T		MT920 V172 - V174 - V175
S302344Z		TC920 5M62A - 5M63A - 5M65A
S30235MZ		TC920 5M22A - 5M23A - 5M25A - 5M42 - 5M43 - 5M47 5M54 - YT57 - YT58

Réf./Item		Pile/Battery	Calibres
S302624X		-	V137
S302726T		MT516	V110A
S302726Y		MT516	1M20A
S302726Z		MT516	4M61 - 4M71
S302729N		MT616	3M62A
S302729Y		MT616	V181 - V182
S30273MZ		MT616	3M21A - 3M22A - MT35
S30274MZ		MT616	3M62
S3029109		MT616	5Y75



Accumulateur Citizen®.
 Citizen® capacitor.
 Citizen® Akkumulator.
 Acumulador Citizen®.
 Accumulatore Citizen®.
 Acumulador Citizen®.

Réf./Item		Pile/Battery	Calibres
CT295.28		MT621	8510 - 8627
CT295.29		MT920	0850A - 0855A - 0870A - 0875A
CT295.31		MT1620	9447 - 9448 - 9455 - 9457
CT295.33		MT621	8511A - 8512A - 8515A - 862A - 8626A - 8628A 8629A - 8651 - 8730
CT295.34		MT920	7820A - 7870A - 7872A - 7875A - 7877A
CT295.37	-	-	→ CT295.55
CT295.38		MT920	C601 - C605 - C615
CT295.39		MT920	5080
CT295.40	-	-	→ CT295.56
CT295.41		MT616	A310A - A315A
CT295.44		MT1620	A160 - A270 - C690
CT295.45	-	-	→ CT295.63
CT295.46	-	-	→ CT295.61
CT295.50	-	-	→ CT295.55
CT295.51		MT621	E000M - E001M - E010M - E011M - E030M - E031M E068M - E100M - E101M - E110M - E111M - E168M E410G - G430M - G431M - G530G - H500M - H501M H570M - H571M

Réf./Item		Pile/Battery	Calibres
CT295.53		US2025	D600
CT295.55		MT621	A114A - A119A - A134A - A234 - A234A - A239A BP10 - F810M - F910M - 8S11
CT295.56		MT920	7W71 - 7821A - 7828A - 7871A - 7873 - 7876 7878 - 7879 - A730-G - B510 - B690 - B800M B810M - B870M - B873M
CT295.60		MT621	B232M - B236M - B237M - BP10
CT295.61	-	-	→ CT295.76
CT295.63*		MT621	B230M - B234M - B235M
CT295.67		MT416F	G620M - G670M - G671M - J620M
CT295.69		CTL920	E600M - E610M - E670M - G900M
CT295.758		CTL920	E310M - E690M - U200 - U700 - U706
CT295.76		MT516	B023M - B033M - B035M - B036M - H335M H338M - H360M - H380M - J015M - J165M
CT295.763		MT516	J015M - J165M

* Jusqu'à épuisement des stocks / Will be discontinued after end of stock / Solange Vorrat / Hasta agotamiento del stock
 Fino ad esaurimento dello stock / Até esgotamento do stock



Assortiment de brides de fixation de pile ; **Miyota.**

Assortment of battery clamps ; **Miyota.**

Sortiment von Batteriehaltefeder ; **Miyota.**

Surtido de bridas de fijación de batería ; **Miyota.**

Assortimento di bride di fissaggio della batteria ; **Miyota.**

Sortido de bridas de fixação de pilha ; **Miyota.**

MSA	Qt.	Kg
99.077	33x	0.025

**Contenu - Contents - Inhalt - Contenido - Contenuto - Conteúdo :
 11 modèles - models - Modelle - modelos - modelli - modelos**

Réf./Item no.	Calibres
3x MY231.105	0U30 - 2005 - 2015 - 2025 - 2034 - 2035 - 2115 - 213D
3x MY231.153	3S10 - 3S31 - 3S70
3x MY231.163	5S00 - 5S10 - 6L12 - 6L15 - 6L30 - 6M15 - 6M17
3x MY231.1634	6P29 - 6P89 - 6P90
3x MY231.174	5Y20 - 5Y26 - 5Y30 - 5Y36
3x MY231.182	5R20 - 5R21 - 5R - 5R31 - 5R32 - 5R37
3x MY231.183	6T50 - 6T60 - 6T65 - 6T66
3x MY231.345	0S10 - 0S20 - 0S30 - 0S31 - 0S40 - 0S60 - 0S70 - 0610
3x MY231.347	T200 - T205 - T240 - T241 - T250
3x MY231.368	1L02 - 1L12 - 1L22 - 1L32 - 1L40 - 1L45 - 1S13 - 9T13 - 9T15 - 9T22 - 9T33
3x MY231.3681	T480

A series of horizontal dotted lines for taking notes, spanning the width of the page.

Art. MSA Pages

MSA46.

46.910-x	2-52
46.911 ... 46.914	2-52
46.920-x	2-53
46.921 ... 46.924	2-53

MSA47.

47.000	6-3
47.001	6-3
47.002	6-3
47.003-x	6-2
47.005	6-4
47.101	5-9, 6-5

MSA50.

50.300	11-17
50.302 ... 50.332	11-17
50.S25192	11-17
50.S25206	11-17
50.S25206C	11-17
50.S25246	11-17
50.S25246C	11-17
50.S25286	11-17
50.S25286C	11-17
50.S25295	11-17
50.S25295C1	11-17
50.S25295C2	11-17
50.S25315C	11-17

MSA51.

51.000 ... 51.005	10-2
51.006-x	10-7
51.007	10-2
51.008-x	10-4
51.009-x	10-5
51.010-x	10-4
51.011-x	10-6
51.012-x	10-6
51.013-x	10-9
51.014-x	10-9
51.015-x	10-8
51.016-x	10-8
51.017 ... 51.022	10-5
51.023-x	10-5
51.025-x	10-3

MSA51.

51.000 ... 51.005	10-2
51.006-x	10-7
51.007	10-2
51.008-x	10-4
51.009-x	10-5
51.010-x	10-4
51.011-x	10-6
51.012-x	10-6
51.013-x	10-9
51.014-x	10-9
51.015-x	10-8
51.016-x	10-8
51.017 ... 51.022	10-5
51.023-x	10-5
51.025-x	10-3

MSA55.

55.001	15-6
55.002	15-6

Art. MSA Pages

MSA55.

55.003	15-6
55.004	15-7
55.005	15-7
55.006	15-7
55.007	15-8
55.008	15-7
55.009	15-6
55.010	15-6
55.012	15-8
55.013	15-9
55.014	15-7
55.015	15-7
55.016	15-6
55.017	15-7
55.018	15-6
55.019	15-6
55.020	15-7
55.021	15-8
55.022	15-7
55.023	15-6
55.024	15-6
55.025	15-8
55.026	15-7
55.027	15-8
55.028	15-8
55.029	15-9
55.035	15-6
55.036	15-7
55.037	15-6
55.038	15-7
55.039	15-8
55.040	15-9
55.041	15-9
55.042	15-9
55.043	15-9
55.045	15-8
55.046	15-9
55.047	15-8
55.048	15-7
55.049	15-9
55.054-S	15-6
55.102	15-9
55.128	15-8
55.130	15-7
55.131	15-9
55.132	15-8
55.201	15-7
55.202	15-7
55.295	15-10
55.296	15-10
55.300	15-6
55.301	15-8
55.303	15-8
55.304	15-8
55.307	15-7
55.308	15-8
55.311	15-8
55.312	15-9
55.313	15-9
55.601 ... 55.605	15-13
55.611 ... 55.615	15-13
55.621	15-13
55.622	15-13
55.623	15-13
55.631	15-14

Art. MSA Pages

MSA55.

55.632	15-14
55.633	15-14
55.651 ... 51.655	15-14
55.661 ... 55.665	15-14
55.671	15-15
55.672	15-15
55.673	15-15
55.681	15-15
55.682	15-15
55.683	15-15
55.901 ... 55.915	15-11
55.920	15-11
55.921	15-11
55.930 ... 55.940	15-12

MSA56.

56.000 ... 56018	8-2
56.020 ... 56.052	8-2
56.054 ... 56.069	8-2
56.071 ... 56.080	8-2
56.500-09	8-4
56.500-8479	5-67, 8-4

MSA60.

60.001 ... 60.007	5-51
60.008	5-52
60.009	5-52
60.010	5-52
60.011	5-55
60.012	5-55
60.013	5-51
60.014	5-51
60.015	5-51
60.015-S	5-51
60.015-T	5-52
60.016	5-52
60.016-S	5-52
60.016-T	5-52
60.017	5-52
60.018	5-51
60.019	5-51
60.021	5-55
60.022	5-51
60.023	5-55
60.024	5-55
60.025	5-51
60.026	5-51
60.027	5-52
60.028	5-52
60.029	5-51
60.030	5-51
60.032	5-51
60.033	5-51
60.035	5-51
60.037	5-51
60.045	5-51
60.055	5-58
60.056	5-58
60.065	5-58
60.067	5-59
60.067-T	5-59
60.320	5-55
60.323	5-55
60.501 ... 60.507	5-51

Art. MSA	Pages
MSA60.	
60.508	5-52
60.509	5-52
60.510	5-52
60.511	5-55
60.512	5-55
60.513	5-51
60.514	5-51
60.515	5-51
60.515-S	5-51
60.515-T	5-52
60.516	5-52
60.516-S	5-52
60.516-T	5-52
60.517	5-52
60.518	5-51
60.519	5-51
60.520	5-55
60.521	5-55
60.522	5-51
60.523	5-55
60.524	5-55
60.525	5-51
60.526	5-51
60.527	5-52
60.528	5-52
60.530	5-51
60.533	5-51
60.534	5-51
60.548	5-59
60.551	5-58
60.567	5-59
60.567-T	5-59
60.600 ... 60.615	5-60
60.700 ... 60.715	5-60
60.716 ... 60.721	5-61
60.802	5-65
60.804	5-65
60.806	5-65
60.810	5-65
60.815	5-65
60.825	5-65
60.826	5-65
60.828	5-65
60.845	5-65
60.860 ... 60.864	5-65
60.901	5-65
60.902	5-65
60.904	5-65
60.906	5-65
60.915	5-65
60.926	5-65
60.961	5-65
MSA61.	
61.001 ... 61.016	7-6
61.051 ... 61.060	7-8
61.101 ... 61.109	7-4
61.151 ... 60.161	7-4
61.201 ... 61.204	7-10
61.206	7-10
61.207	7-10
61.301	7-10
61.310 ... 61.320	7-12
61.322 ... 61.329	7-12
61.331 ... 61.345	7-12

Art. MSA	Pages
MSA61.	
61.401 ... 61.410	7-2
61.411	7-11
61.412	7-11
61.413	7-2
61.414	7-2
61.415	7-2
61.501 ... 61.516	7-6
61.551 ... 61.560	7-8
61.601 ... 61.609	7-4
61.651 ... 61.661	7-4
61.701 ... 61.707	7-10
61.801 ... 61.810	7-2
61.811	7-11
61.812	7-11
61.813	7-2
61.814	7-2
61.815	7-2
61.816	7-11
61.908	7-2
61.911	7-11
61.912	7-11
MSA63.	
63.001 ... 63.005	5-47
63.005-120	5-47
63.006	5-48
63.006-120	5-48
63.050 ... 63.055	5-47
63.057	5-47
63.058	5-48
63.059	5-48
63.100	5-49
63.101	5-49
63.102	5-49
63.150 ... 63.155	5-49
63.155-120	5-49
63.200 ... 63.206	5-49
63.501	5-47
63.502	5-47
63.503	5-47
63.503-140	5-47
63.504	5-47
63.504-120	5-47
63.505	5-47
63.505-120	5-47
63.505-140	5-47
63.506	5-48
63.506-120	5-48
63.506-140	5-48
63.550 ... 63.555	5-47
63.555-100	5-47
63.557	5-47
63.557-120	5-47
63.558-090	5-48
63.558-110	5-48
63.558-120	5-48
63.558-140	5-48
63.559-090	5-48
63.559-140	5-48
63.600	5-49
63.601	5-49
63.602	5-49
63.650 ... 63.654	5-49
63.654-120	5-49
63.655	5-49
MSA66.	
66.020	14-2
66.023	14-2
66.026	14-2
66.027	14-2
66.029	14-2
66.030	14-3
66.033 ... 66.036	14-3
66.038	14-3
66.039	14-3
66.040	14-3
66.043 ... 66.046	14-3
66.048	14-3
66.049	14-3
66.060	14-4
66.064	14-4
66.066	14-4
66.068	14-4
66.069	14-4
66.070	14-4
66.073	14-4
66.076	14-4
66.080 ... 66.085	14-6
66.086	14-10
66.087	14-6
66.090	14-7
66.091	14-7
66.093	14-7
66.094	14-7
66.095	14-7
66.096	14-10
66.100	14-8
66.101	14-7, 14-8
66.102	14-7, 14-8
66.103	14-10
66.104	14-10
66.105	14-10
66.106	14-8
66.107	14-7, 14-8
66.108	14-7
66.109	14-7, 14-8
66.110 ... 66.114	14-9
66.200 ... 66.204	14-5
66.210 ... 66.214	14-5

Art. MSA	Pages
MSA63.	
63.655-120	5-49
63.700 ... 63.706	5-49
MSA65.	
65.001	6-6, 6-8
65.001-A	1-15, 6-6
65.002	6-6, 6-8
65.002-A	1-15, 6-6
65.003	6-6, 6-8
65.003-A	1-15, 6-6
65.004	6-6, 6-8
65.004-A	1-15, 6-6
65.004-R	6-6
65.005	6-6, 6-8
65.005-A	1-15, 6-6
65.006	6-6, 6-8
65.006-A	1-15, 6-6
65.007	6-6
65.008	6-6
MSA66.	
66.020	14-2
66.023	14-2
66.026	14-2
66.027	14-2
66.029	14-2
66.030	14-3
66.033 ... 66.036	14-3
66.038	14-3
66.039	14-3
66.040	14-3
66.043 ... 66.046	14-3
66.048	14-3
66.049	14-3
66.060	14-4
66.064	14-4
66.066	14-4
66.068	14-4
66.069	14-4
66.070	14-4
66.073	14-4
66.076	14-4
66.080 ... 66.085	14-6
66.086	14-10
66.087	14-6
66.090	14-7
66.091	14-7
66.093	14-7
66.094	14-7
66.095	14-7
66.096	14-10
66.100	14-8
66.101	14-7, 14-8
66.102	14-7, 14-8
66.103	14-10
66.104	14-10
66.105	14-10
66.106	14-8
66.107	14-7, 14-8
66.108	14-7
66.109	14-7, 14-8
66.110 ... 66.114	14-9
66.200 ... 66.204	14-5
66.210 ... 66.214	14-5

Art. MSA Pages

MSA70.

70.001	13-2
70.002	13-2
70.003-x	13-4
70.004	13-2
70.005	13-2
70.006-x	13-3
70.007-x	13-6
70.008-150	13-4
70.008-60	13-5
70.008-60-A	13-5
70.008-70	13-5
70.008-A4	13-5
70.009-x	13-5
70.010-x	13-6
70.013-x	13-4
70.016-x	13-3

MSA71.

71.011-x	9-2
71.500 ... 71.517	9-3
71.600 ... 71.617	9-4
71.700 ... 71.716	9-5
71.800	9-6

Art. MSA Pages

MSA80.

80.001 ... 80.009-x	5-34
80.009	5-35
80.009-070	5-35
80.009-080	5-35
80.010 ... 80.013-x	5-34
80.014 ... 80.022	5-35
80.501 ... 80.508-x	5-34
80.509	5-35
80.509-070	5-35
80.509-080	5-35
80.510 ... 80.513-x	5-34
80.514 ... 80.522	5-35

MSA81.

81.001	5-39
81.002	5-39
81.004	5-39
81.006	5-39
81.007	5-39
81.008	5-39
81.009	5-39
81.101 ... 81.115	5-40
81.201	5-42
81.202	5-42
81.204 ... 81.212	5-42
81.213 ... 81.228	5-43
81.229 ... 81.240	5-44
81.241	5-42
81.243 ... 81.246	5-42
81.247	5-43
81.248	5-42
81.249	5-44
81.250 ... 81.254	5-43
81.255	5-44
81.256	5-44
81.257	5-44
81.258	5-42
81.259	5-43
81.260	5-43
81.262	5-42
81.263	5-43
81.264	5-43
81.265	5-42
81.266	5-43
81.271	5-43
81.275	5-42
81.276	5-44
81.278	5-44
81.504	5-39
81.506	5-39
81.507	5-39
81.601	5-40
81.602	5-40
81.606	5-40
81.613	5-40
81.614	5-40
81.615	5-40
81.702	5-42
81.704	5-42
81.705	5-42

Art. MSA Pages

MSA81.

81.707 ... 81.712	5-42
81.713	5-43
81.715	5-43
81.717	5-43
81.718	5-43
81.719	5-43
81.721	5-43
81.722	5-43
81.725	5-43
81.726	5-43
81.727	5-43
81.729	5-44
81.730	5-44
81.731	5-44
81.734	5-44
81.735	5-44
81.737	5-44
81.738	5-44
81.740	5-44
81.741	5-44
81.742	5-42
81.743	5-44
81.744	5-43
81.745	5-44
81.750	5-43
81.761	5-43
81.766	5-43
81.772	5-43
81.773	5-44
81.774	5-44
81.777	5-44

MSA82.

82.001-x ... 82.009-x	5-4
82.051-x ... 82.058-x	5-6
82.201-x ... 82.208-x	5-4
82.251-x ... 82.258-x	5-6

MSA83.

83.202-090 ... 83.207-090	5-11
83.252-090 ... 83.257-090	5-8
83.272-090 ... 83.277-090	5-8
83.302-090 ... 83.307-090	5-11
83.401 ... 83.405	5-9
83.451	5-9
83.452	5-9
83.453	5-9

MSA84.

84.202-x ... 84.204-x	5-14
84.212-x ... 84.213-x	5-14
84.223-x ... 83.225-x	5-14
84.226-090	5-15
84.227-090	5-15
84.235-x	5-14
84.236-090	5-15
84.237-090	5-15
84.239-090	5-15
84.252-x ... 84.253-x	5-22
84.262-x ... 84.263-x	5-22
84.273-x ... 84.275-x	5-22
84.276-090	5-23
84.277-090	5-23
84.285-x ... 84.287-x	5-23
84.289-090	5-23

Art. MSA	Pages
MSA84.	
84.302-x ... 84.304-x	5-14
84.312-x ... 84.313-x	5-14
84.323-x ... 84.325-x	5-14
84.326-090	5-15
84.327-090	5-15
84.335-x	5-14
84.336-090	5-15
84.337-090	5-15
84.339-090	5-15
84.340-090	5-15
84.352-x ... 84.353-x	5-22
84.362-x ... 84.363-x	5-22
84.373-x ... 84.375-x	5-22
84.376-090	5-23
84.377-090	5-23
84.385-x ... 84.387-x	5-23
84.389-090	5-23
84.401-090	5-14
84.402-090	5-14
84.403-090	5-14
84.404-090	5-15
84.405-090	5-15
84.406-090	5-15
84.411-090	5-14
84.412-090	5-14
84.413-090	5-14
84.414-090	5-15
84.415-090	5-15
84.416-090	5-15
84.421-090 ... 84.426-090	5-15
84.427-090 ... 84.431-090	5-16
84.432-090	5-17
84.441-090 ... 84.446-090	5-15
84.447-090 ... 84.450-090	5-16
84.451-090	5-17
84.452-090	5-17
84.453-090	5-15
84.454-090	5-15
84.455-090 ... 84.459-090	5-16
84.460-090	5-17
84.461-090	5-17
84.465-090	5-15
84.466-090	5-15
84.467-090 ... 84.471-090	5-16
84.472-090	5-17
84.473-090	5-17
84.475-090	5-15
84.476-090	5-15
84.477-090 ... 84.481-090	5-16
84.482-090	5-17
84.483-090	5-17
84.485-090	5-15
84.486-090	5-15
84.487-090 ... 84.491-090	5-16
84.492-090	5-17
84.493-090	5-17
84.501-090	5-14
84.502-090	5-14
84.503-090	5-14
84.504-090	5-15
84.505-090	5-15
84.506-090	5-15
84.511-090	5-14
84.512-090	5-14
84.513-090	5-14

Art. MSA	Pages
MSA84.	
84.514-090	5-15
84.515-090	5-15
84.516-090	5-15
84.601-090	5-22
84.602-090	5-22
84.603-090	5-22
84.604-090	5-23
84.605-090	5-23
84.606-090	5-23
84.611-090	5-22
84.612-090	5-22
84.613-090	5-22
84.614-090	5-23
84.615-090	5-23
84.616-090	5-23
84.618-090	5-22
84.619-090	5-22
84.620-090	5-22
84.621-090 ... 84.625-090	5-23
84.626-090 ... 84.630-090	5-24
84.631-090	5-25
84.632-090	5-25
84.641-090 ... 84.645-090	5-23
84.646-090 ... 84.650-090	5-24
84.651-090	5-25
84.652-090	5-25
84.660-090	5-23
84.661-090	5-23
84.662-090 ... 84.666-090	5-24
84.667-090	5-25
84.668-090	5-25
84.670-090	5-23
84.671-090	5-23
84.672-090 ... 84.676-090	5-24
84.677-090	5-25
84.678-090	5-25
84.680-090	5-23
84.681-090	5-23
84.682-090 ... 84.686-090	5-24
84.687-090	5-25
84.688-090	5-25
84.690-090	5-23
84.691-090	5-23
84.692-090 ... 84.696-090	5-24
84.697-090	5-25
84.698-090	5-25
84.701-090	5-22
84.702-090	5-22
84.703-090	5-22
84.704-090	5-23
84.705-090	5-23
84.706-090	5-23
84.711-090	5-22
84.712-090	5-22
84.713-090	5-22
84.714-090	5-23
84.715-090	5-23
84.716-090	5-23
84.720-090	5-22
84.721-090	5-22
84.722-090	5-22
84.723-090	5-23
84.724-090	5-23
84.725-090	5-23
84.800-090	5-32

Art. MSA	Pages
MSA84.	
84.801-090	5-32
84.802-090	5-32
84.804-090	5-32
84.807-090 ... 84.809-090	5-32
84.810-090 ... 84.833-090	5-30
84.900-090 ... 84.909-090	5-32
84.910-090 ... 84.923-090	5-30
MSA85.	
85.001 ... 85.010	5-66
85.011 ... 85.016	5-67
85.042 ... 85.046	5-66
85.050	5-66
85.052 ... 85.057	5-67
85.082	5-66
85.084	5-66
85.085	5-66
85.086	5-66
85.088	5-66
85.089	5-66
85.090	5-66
85.092 ... 85.096	5-67
85.101	5-68
85.102	5-68
85.103	5-68
85.106	5-68
85.107	5-68
85.109	5-68
85.110	5-68
85.112	5-68
85.115 ... 85.119	5-68
85.122	5-69
85.123	5-69
85.124	5-69
85.130	5-69
85.131	5-69
85.133	5-69
85.134	5-69
85.137	5-69
85.202 ... 85.207	5-68
85.209	5-68
85.211	5-68
85.216	5-68
85.218	5-68
85.226	5-69
85.229	5-69
85.230	5-69
85.234	5-69
85.236	5-69
85.238	5-69
85.240	5-69
85.401	5-67
85.520	5-70
85.603	5-70
85.606	5-70
85.611	5-70
85.614	5-70
85.618	5-70
85.619	5-70
85.627	5-70
85.703	5-70

Art. MSA	Pages
MSA99.	
99.263	5-28
99.264	5-28
99.265	5-20
99.266	5-21
99.267	5-28
99.268	5-29
99.269	5-21, 5-29
99.270	5-21, 5-29
PERF44..	
44.000 ... 44.018	15-2
44.020 ... 44.036	15-2
44.050	15-2
44.051	15-2
44.052	15-2
44.090 ... 44.104	15-3
44.200 ... 44.213	15-3
44.250	15-3
44.251	15-3
PERF48.	
48.000	3-22, 15-4
48.001	3-22, 15-4
48.100	15-5
48.101	15-5
48.200	15-5
PIL.	
001	16-5
002	16-5
PILE	
10	16-4
123	16-4
13	16-4
301	16-2
303	16-2
309	16-2
312	16-4
314	16-2
317	16-2
317VPO	16-2
319	16-2
321	16-2
321VPO	16-2
329	16-2
335	16-2
335VPO	16-2
337	16-2
341	16-2
341VPO	16-2
344	16-2
346	16-2
350	16-2
357	16-2
361	16-2
362	16-2
362/361VPO	16-2
363	16-2
364	16-2
364/363VPO	16-2
365	16-2
366	16-2
370	16-2
371	16-2

Art. MSA	Pages
PILE	
371/370VPO	16-2
373	16-2
376	16-2
377	16-2
377/376VPO	16-2
379	16-2
379VPO	16-2
380	16-2
384	16-2
386	16-2
389	16-2
390	16-2
391	16-2
392	16-2
393	16-2
394	16-2
394/380VPO	16-2
395	16-2
395/399VPO	16-2
396	16-2
399	16-2
6LR61VRAC12	16-4
A23	16-4
A27/2	16-4
A544	16-4
BR1225	16-3
BR2325	16-3
BR2330	16-3
CR1025	16-3
CR1216	16-3
CR1220	16-3
CR1616	16-3
CR1620	16-3
CR1632	16-3
CR2	16-3
CR2-12	16-3
CR2025	16-3
CR2032-2	16-3
CR2320	16-3
CR2430-2	16-3
CR2450-2	16-3
E11A	16-4
EPX625	16-4
EPX76	16-4
ER3S1/2AA	16-4
HR03	16-4
HR14	16-4
HR6	16-4
L91	16-4
L92	16-4
LR03	16-4
LR03VP	16-4
LR03VRAC10	16-4
LR1	16-4
LR14	16-4
LR14VRAC12	16-4
LR1VRAC576	16-4
LR20	16-4
LR20VRAC12	16-4
LR43	16-4
LR44	16-4
LR54	16-4
LR6	16-4
LR61	16-4
LR6VP	16-4

Art. MSA	Pages
PILE	
LR6VRAC10	16-4
LS14250	16-3
LS14500	16-3
LS33600	16-3
S.	
302265U	16-6
302324L	16-6
302324M	16-6
302324P	16-6
302324R	16-6
302324T	16-6
302324X	16-6
302324Y	16-6
302334T	16-6
302344Z	16-6
30235MZ	16-6
302624X	16-7
302726T	16-7
302726Y	16-7
302726Z	16-7
302729N	16-7
302729Y	16-7
30273MZ	16-7
30274MZ	16-7
3029109	16-7
VLX	
ETC137 ... ETC380	11-12
JOINT/1140X08 ... /1400X08	11-15
JOINT/1250X12 ... /1405X12	11-15
JOINT/L175 ... /L365	11-16
MBE240 ... MBE430	11-7
MCV164 ... MCV500	11-13
MDN90 ... MDN380	11-12
ML4.5X3.6	11-8
ML5.9X4.7	11-8
ML7.5X6.3	11-8
MMB140 ... MMB400	11-6
MME180 ... MME450	11-4
MMS/JI140 ... MMS/JI400	11-3
MMS130 ... MMS460	11-3
MNP155 ... MNP450	11-4
MNR/PJ176 ... MNR/PJ371	11-5
MPL/B/SPx	11-11
MPL/B22X07	11-11
MPL/B35X09	11-11
MPL/G/SP280X370X60	11-11
MPL/G/SP430Xx	11-11
MPL/G/SP450X320X40	11-11
MPL/G/SP500Xx	11-11
MPL/G220Xx	11-11
MPL/G300Xx	11-11
MPL/G350Xx	11-11
MPL/G370Xx	11-11
MPL/SP40Xx	11-10
MPL/SP50Xx	11-10
MPL/SP55Xx	11-10
MPL15Xx	11-10
MPL20Xx	11-10
MPL25Xx	11-10
MPL30Xx	11-10
MPL35Xx	11-10
MPL40Xx	11-10
MPL45Xx	11-10

Art. MSA Pages

VLX

MSB180 ... MSB430	11-7
MSE175 ... MSE450	11-5
MTE250 ... MTE450	11-6
MTL/C241 ... MTL/C373	11-14
MTL/D141 ... MTL/D373	11-14
MUM120 ... MUM340	11-3
NMB100 ... NMB500	11-13
NML100 ... NML700	V11-12
SRD260 ... SRD335	11-9
SRM260 ... SRM335	11-9
SRV120 ... SRV335	11-9
SVN200 ... SVN500	11-13
XMF155/725 ... XMF500/617	11-8

Art. MSA Pages

Art. MSA Pages



Le catalogue HOROTEC® WATCH PARTS SERVICE est édité à La Chaux-de-Fonds, Suisse, Copyright © 2018.
Reproduction, modification et diffusion partielles ou totales sont interdites sans l'autorisation écrite de l'éditeur.
Tous droits réservés.

*The HOROTEC® WATCH PARTS SERVICE catalogue is published in La Chaux-de-Fonds, Switzerland, Copyright © 2018.
Reproduction, modification and distribution in part or whole is forbidden without written permission from the Editor.
All rights reserved.*

Der HOROTEC® WATCH PARTS SERVICE Katalog wird an La Chaux-de-Fonds veröffentlicht, Copyright © 2018.
Nachdruck, auch auszugsweise, ist nur mit schriftlicher Genehmigung gestattet.
Alle Rechte vorbehalten.

*El catálogo HOROTEC® WATCH PARTS SERVICE es publicado en La Chaux-de-Fonds, Suiza, Copyright © 2018.
Reproducción, modificación y difusión parciales o totales son prohibidas sin la autorización escrita del editor.
Todos los derechos reservados.*

Il catalogo HOROTEC® WATCH PARTS SERVICE è pubblicato a La Chaux-de-Fonds, Svizzera, Copyright © 2018.
Riproduzione, modificazione e diffusione parziali o totali sono vietate senza l'autorizzazione scritta dell'editore.
Tutti i diritti riservati.

*O catálogo HOROTEC® WATCH PARTS SERVICE é editado em La Chaux-de-Fonds, Suíça, Copyright © 2018.
Reprodução, modificação e difusão parciais ou totais são proibidas sem autorização escrita do editor.
Todos os direitos reservados.*