

HOROTEC[®]
SWISS

L'outil Horloger...

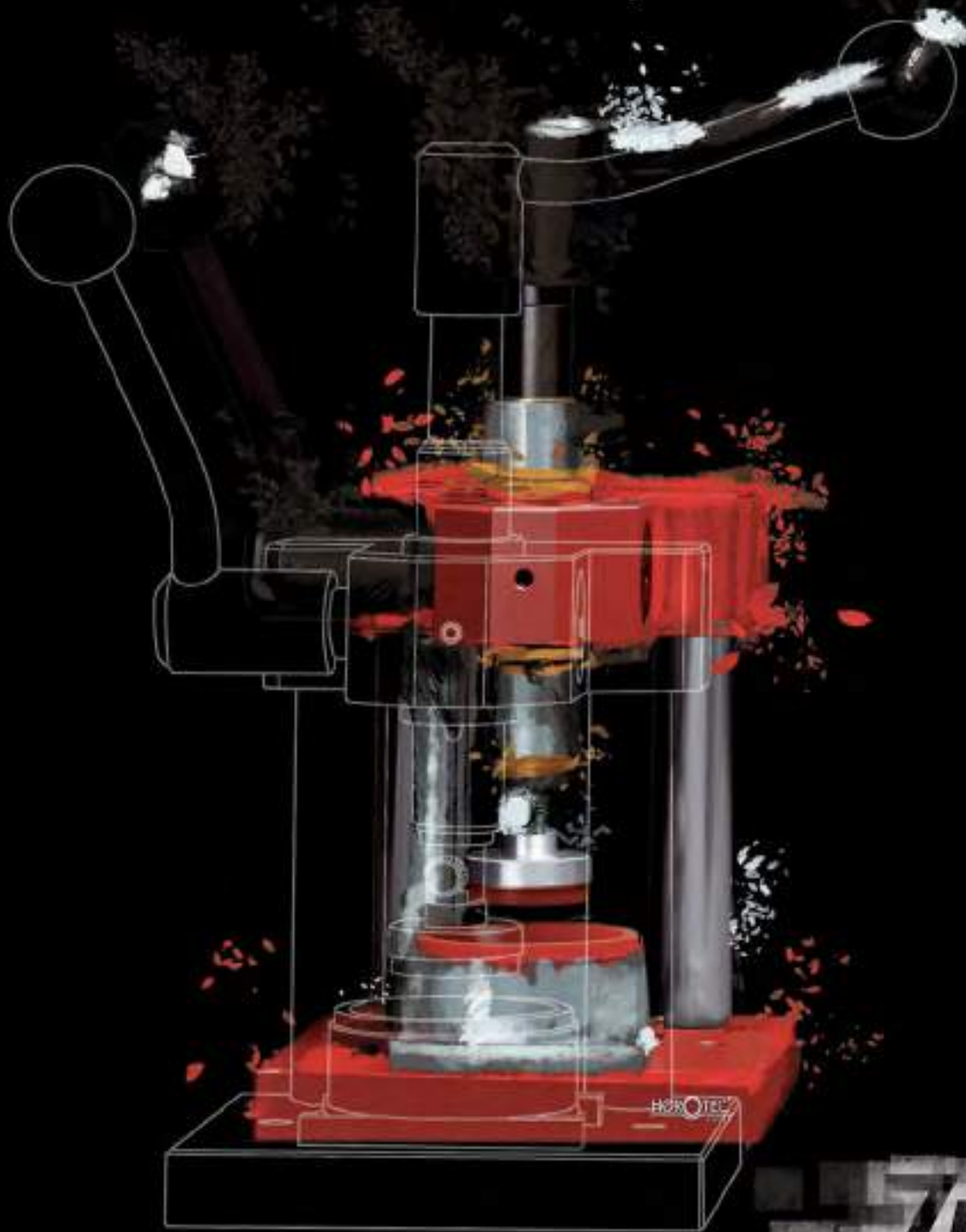

2021

TOOLS CATALOG



75TH

1946 ANNIVERSARY 2021

00

Eyeglasses - Lamps

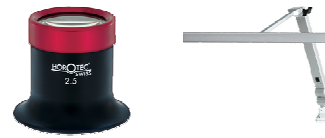

01

Screwdrivers and blades
Tools for shaping and sharpening blades



02

Pin vices - Cutting and smoothing broaches



03

Specialized watch making tools - Lathes
Riveting stakes - Drill machines



04

Hammers - Anvils - Saw frames
Saw blades - Taps/Draw plates



05

Hands fitting tools/presses
Hands removing presses
Hands removing tools

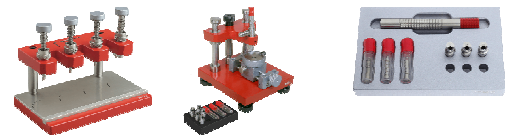

06/07

Universal presses and dies
Presses/Tools for screw/unscrew case backs
Tools for snap-on case backs - Other tools
Glass machine



08

Case holders - Vices



09

Movement holders - Case cushions



SUMMARY

10

Bracelet presses
Bracelet tools - Spring bars tools



11

Pliers



12

Tweezers



13

Jewelling presses - Riveting and milling presses -
Incabloc®/KIF®



14

Video inspection systems - Microscopes
Lighting - Camera



15

Measuring instruments



16

Arkansas stones - India stones - Degussit stones
Synthetic stones



17

Oilers - Oil cups - Packaging



18

Handles for files, gravers and hammers



19

Apparatus/Machines : Testers / Watch winders / Waterproof Cleaning / Packaging / Vacuum/Compressed air / Adhesives Polymerisation/UV / Magnetism



20

Micromotors



21

Small brushes - Polishers - Circular graining sticks
Hand brushes - Circular brushes

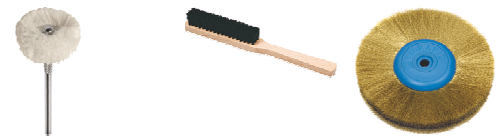

22

End mills - Reamers - Diamond burs - Drills



23

Polishing tools - Polishing machines
Sandblasters - Suction



24

Benches - Chairs
Bench accessories



26

Polishing/Abrasives - Protections - Cleaning Solutions - Luminous pigments - Other articles
Glues/Adhesives



28

Oils - Greases - Lubricants - Epilames



29

Soldering - Electro lettering device



32

Beading tools - Beading tools plates - Millgrain tools



38

Reagents - Diamond testers - Wrapping paper



42

Balances



98

Professional kits



Economical items



Files - Diamond products - Ceramic fibres
Gravers - Rifflers - Rasps - Handles



L'outil Horloger...

Copyright © 2021. All rights reserved.
Reproduction and modification in part or whole are forbidden without written permission.
HOROTEC® trademark is registered in Switzerland, U.S.A., Europe and many other countries.
Other registered trademarks or product names are the property of their respective owners.
We reserve the right to modify the specifications of products without prior notice.

DOCHOR.TOOLS21-EN

00



EYEGASSES

00 - 2

LAMPS

00 - 13

Horotec eyeglasses.



MSA	No.	Magnification	Ø lens	Kg
00.031-1	1	10.0x	25 mm	0.024
00.031-1.5	1.5	6.5x	25 mm	0.024
00.031-2	2	5.0x	25 mm	0.024
00.031-2.5	2.5	4.0x	25 mm	0.024
00.031-3	3	3.5x	25 mm	0.024
00.031-3.5	3.5	3.0x	25 mm	0.024
00.031-4	4	2.5x	25 mm	0.024

Aluminium eyeglass, classic shape with screwed aluminium bezel and removable lens. Nice finish, very light and sturdy. Red anodised.

On request and from 50 pieces (assorted magnifications), these eyeglasses are available with different colours of body and bezel and customized.



MSA	No.	Magnification	Ø lens	Kg
00.032-1	1	10.0x	25 mm	0.020
00.032-1.5	1.5	6.5x	25 mm	0.020
00.032-2	2	5.0x	25 mm	0.020
00.032-2.5	2.5	4.0x	25 mm	0.020
00.032-3	3	3.5x	25 mm	0.020
00.032-3.5	3.5	3.0x	25 mm	0.020
00.032-4	4	2.5x	25 mm	0.020

Black plastic eyeglass, classic shape with screwed aluminium bezel and removable lens. Nice finish, very light and sturdy.

On request and from 50 pieces (assorted magnifications), these eyeglasses are available with different colours of bezel and customized.



MSA	No.	Magnification	Ø	Kg
00.030-L1	1	10.0x	25 mm	0.005
00.030-L1.5	1.5	6.5x	25 mm	0.005
00.030-L2	2	5.0x	25 mm	0.005
00.030-L2.5	2.5	4.0x	25 mm	0.005
00.030-L3	3	3.5x	25 mm	0.005
00.030-L3.5	3.5	3.0x	25 mm	0.005
00.030-L4	4	2.5x	25 mm	0.005

Spare lens for MSA00.031-x and MSA00.032-x.



MSA	No.	Magnification	Ø lens	Kg
00.025-1	1	10.5x	22.50 mm	0.016
00.025-1.5	1.5	7.75x	22.50 mm	0.016
00.025-2	2	5.75x	22.50 mm	0.016
00.025-2.5	2.5	5.0x	22.50 mm	0.016
00.025-3	3	4.25x	22.50 mm	0.016
00.025-3.5	3.5	3.75x	22.50 mm	0.016
00.025-4	4	3.5x	22.50 mm	0.016

Black plastic eyeglass, classic shape with screwed red aluminium bezel and removable lens. Nice finish, very light and sturdy.



MSA	No.	Magnification	Ø	Kg
00.002-L1	1	10.50x	22.50 mm	0.005
00.002-L1.5	1.5	7.75x	22.50 mm	0.005
00.002-L2	2	5.75x	22.50 mm	0.005
00.002-L2.5	2.5	5.00x	22.50 mm	0.005
00.002-L3	3	4.25x	22.50 mm	0.005
00.002-L3.5	3.5	3.75x	22.50 mm	0.005
00.002-L4	4	3.50x	22.50 mm	0.005

Spare lens for MSA00.025-x.

Standard eyeglasses.



MSA	No.	Magnification	Ø lens	Kg
00.001-1	1	10.0x	25 mm	0.012
00.001-1.5	1.5	6.5x	25 mm	0.012
00.001-2	2	5.0x	25 mm	0.012
00.001-2.5	2.5	4.0x	25 mm	0.012
00.001-3	3	3.5x	25 mm	0.012
00.001-3.5	3.5	3.0x	25 mm	0.012
00.001-4	4	2.5x	25 mm	0.012

Black plastic eyeglass ASCO, classic shape with screwed aluminium bezel and blued removable lens.

Nice finish, polished black exterior and matt interior.



MSA	No.	Magnification	Ø	Kg
00.030-L1	1	10.0x	25 mm	0.005
00.030-L1.5	1.5	6.5x	25 mm	0.005
00.030-L2	2	5.0x	25 mm	0.005
00.030-L2.5	2.5	4.0x	25 mm	0.005
00.030-L3	3	3.5x	25 mm	0.005
00.030-L3.5	3.5	3.0x	25 mm	0.005
00.030-L4	4	2.5x	25 mm	0.005

Spare lens for MSA00.001-x.



MSA	No.	Magnification	Ø lens	Kg
00.002-1	1	10.50x	22.50 mm	0.015
00.002-1.5	1.5	7.75x	22.50 mm	0.015
00.002-2	2	5.75x	22.50 mm	0.015
00.002-2.5	2.5	5.00x	22.50 mm	0.015
00.002-3	3	4.25x	22.50 mm	0.015
00.002-3.5	3.5	3.75x	22.50 mm	0.015
00.002-4	4	3.50x	22.50 mm	0.015

Black plastic eyeglass, classic shape with screwed bezel and removable lens. Nice finish and lightweight.



MSA	No.	Magnification	Ø	Kg
00.002-L1	1	10.50x	22.50 mm	0.005
00.002-L1.5	1.5	7.75x	22.50 mm	0.005
00.002-L2	2	5.75x	22.50 mm	0.005
00.002-L2.5	2.5	5.00x	22.50 mm	0.005
00.002-L3	3	4.25x	22.50 mm	0.005
00.002-L3.5	3.5	3.75x	22.50 mm	0.005
00.002-L4	4	3.50x	22.50 mm	0.005

Spare lens for MSA00.002-x.

EYEGASSES



MSA	Ring	No.	Magnification	Ø lens	Kg
00.027-1	Green	1	10.0x	25 mm	0.021
00.027-1.5	Blue	1.5	6.5x	25 mm	0.021
00.027-2	Yellow	2	5.0x	25 mm	0.021
00.027-2.5	Copper	2.5	4.0x	25 mm	0.021
00.027-3	Violet	3	3.5x	25 mm	0.021
00.027-3.5	Black	3.5	3.0x	25 mm	0.021
00.027-4	Aluminium	4	2.5x	25 mm	0.021

Soft rubber eyeglass, classic shape with screwed aluminium bezel and removable lens.



MSA	No.	Magnification	Ø lens	Kg
00.009-1.5	1.5	7.7x	23.50 mm	0.012
00.009-2	2	6.0x	23.50 mm	0.012
00.009-2.5	2.5	5.0x	23.50 mm	0.012
00.009-3	3	4.4x	23.50 mm	0.012
00.009-3.5	3.5	3.8x	23.50 mm	0.012
00.009-4	4	3.5x	23.50 mm	0.012

Black plastic eyeglass with classic shape and nice finish.



MSA	No.	Magnification	Ø lens	Kg
00.008-1	1	10.0x	30 mm	0.015
00.008-1.5	1.5	7.0x	30 mm	0.015
00.008-2	2	5.0x	30 mm	0.015
00.008-2.5	2.5	4.0x	30 mm	0.015

Sturdy black plastic eyeglass, with side hole. Large vision field.

Control eyeglasses.



MSA		No.	Magnification	Ø lens	Kg
00.026-2	(1)	2	5x	40 mm	0.072
00.026-2.5	(2)	2.5	4x	40 mm	0.068

Aluminium ASCO eyeglass for engraver with screwed aluminium bezel and removable bluish lens. Blue anodised.

(1) yellow coloured bezel
(2) copper coloured bezel





MSA	Magnification	Ø lenses	Kg
00.023-08X	8x	22 mm	0.117

Oblique achromatic measuring eyeglass type F+C.
 - 3 corrected lenses
 - 1 scale of 15 mm divided in 0.1 mm.

Spare part :

MSA	Item	Kg
00.023-R	Reticle	0.005



MSA	Magnification	Ø lenses	Kg
00.003-10X	10x	25 mm	0.015
00.003-14X	14x	25 mm	0.015

Black plastic aplanatic control eyeglass ASCO with 2 removable convex lenses and screwed aluminium ring.
 Nice finish, polished black exterior and matt interior.



MSA	Magnification	Ø lenses	Kg
00.004-10X	10x	14 mm	0.019
00.004-12X	12x	14 mm	0.019
00.004-16X	16x	14 mm	0.019
00.004-20X	20x	14 mm	0.019

Black plastic aplanatic control eyeglass ASCO with 2 removable blued convex lenses (best possible optical correction for limited distortion or colour blurring) and screwed aluminium bezel.
 Nice finish, polished black exterior and matt interior.



MSA	Magnification	Ø lenses	Kg
00.006-10X	10x	14 mm	0.015
00.006-12X	12x	14 mm	0.015
00.006-16X	16x	14 mm	0.015
00.006-20X	20x	14 mm	0.015
00.006-25X	25x	12 mm	0.015

Black plastic achromatic control eyeglass ASCO with 3 removable blued highly luminous lenses providing wide range of vision. Screwed aluminium bezel.
 Nice finish, polished black exterior and matt interior.



MSA	Magnification	Ø lenses	Kg
00.010-12	12x	16.00 - 23.50 mm	0.017
00.010-15	15x	16.00 - 23.50 mm	0.017

Black plastic control eyeglass extra-large with 2 removable lenses and a screwed bezel.
Nice finish and lightweight.

Eyeglass holders.

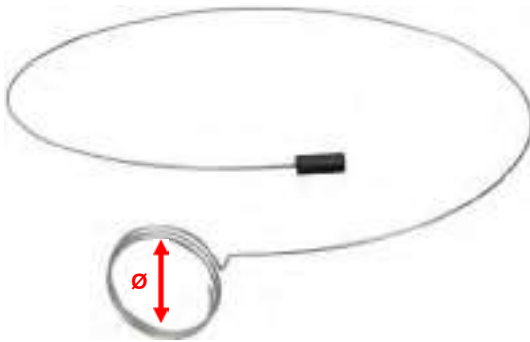

MSA	Ø	Kg
00.014	23 mm	0.005
00.007	30 mm	0.008

Stainless steel wire eyeglass holder.
Adaptable to any type of eyeglass.

ARY® eyeglass for spectacles. Lightweight, removable and pivots upwards when not needed. Easy attachment to the eyeglass frame thanks to the system of spring clip covered with rubber.

ARY®



MSA	Kg
00.100	0.005

Additional eyeglass for ARY® eyeglasses MSA00.099-x, MSA00.100-x and MSA00.103-x. Simply press to fix it.
Additional magnification from 6.5x to 7x.

ARY®



For SMALL sized spectacles

MSA	Eye	No.	Magnification	Ø lens	Kg
00.099G-1	Left	1	10.0x	25 mm	0.025
00.099G-1.5	Left	1.5	6.5x	25 mm	0.025
00.099G-2	Left	2	5.0x	25 mm	0.025
00.099G-2.5	Left	2.5	4.0x	25 mm	0.025
00.099G-3	Left	3	3.5x	25 mm	0.025
00.099G-3.5	Left	3.5	3.0x	25 mm	0.025
00.099G-4	Left	4	2.5x	25 mm	0.025
00.099D-1	Right	1	10.0x	25 mm	0.025
00.099D-1.5	Right	1.5	6.5x	25 mm	0.025
00.099D-2	Right	2	5.0x	25 mm	0.025
00.099D-2.5	Right	2.5	4.0x	25 mm	0.025
00.099D-3	Right	3	3.5x	25 mm	0.025
00.099D-3.5	Right	3.5	3.0x	25 mm	0.025
00.099D-4	Right	4	2.5x	25 mm	0.025

Spare parts :

MSA	Item	Kg
00.099D-A1	Small right clip	0.004
00.099G-A1	Small left clip	0.004





MSA	No.	Magnification	Ø	Kg
00.030-L1	1	10.0x	25 mm	0.005
00.030-L1.5	1.5	6.5x	25 mm	0.005
00.030-L2	2	5.0x	25 mm	0.005
00.030-L2.5	2.5	4.0x	25 mm	0.005
00.030-L3	3	3.5x	25 mm	0.005
00.030-L3.5	3.5	3.0x	25 mm	0.005
00.030-L4	4	2.5x	25 mm	0.005

Spare lens for exeglasses with lenses Ø 25 mm.

ARY[®]



For STANDARD sized spectacles

MSA	Eye	No.	Magnification	Ø lens	Kg
00.100G-1	Left	1	10.0x	25 mm	0.027
00.100G-1.5	Left	1.5	6.5x	25 mm	0.027
00.100G-2	Left	2	5.0x	25 mm	0.027
00.100G-2.5	Left	2.5	4.0x	25 mm	0.027
00.100G-3	Left	3	3.5x	25 mm	0.027
00.100G-3.5	Left	3.5	3.0x	25 mm	0.027
00.100G-4	Left	4	2.5x	25 mm	0.027
00.100D-1	Right	1	10.0x	25 mm	0.027
00.100D-1.5	Right	1.5	6.5x	25 mm	0.027
00.100D-2	Right	2	5.0x	25 mm	0.027
00.100D-2.5	Right	2.5	4.0x	25 mm	0.027
00.100D-3	Right	3	3.5x	25 mm	0.027
00.100D-3.5	Right	3.5	3.0x	25 mm	0.027
00.100D-4	Right	4	2.5x	25 mm	0.027

Spare parts :

MSA	Item	Kg
00.100D-A	Standard right clip	0.005
00.100G-A	Standard left clip	0.005



ARY[®]



For LARGE sized spectacles

MSA	Eye	No.	Magnification	Ø lens	Kg
00.103G-1	Left	1	10.0x	25 mm	0.022
00.103G-1.5	Left	1.5	6.5x	25 mm	0.022
00.103G-2	Left	2	5.0x	25 mm	0.022
00.103G-2.5	Left	2.5	4.0x	25 mm	0.022
00.103G-3	Left	3	3.5x	25 mm	0.022
00.103G-3.5	Left	3.5	3.0x	25 mm	0.022
00.103G-4	Left	4	2.5x	25 mm	0.022
00.103D-1	Right	1	10.0x	25 mm	0.022
00.103D-1.5	Right	1.5	6.5x	25 mm	0.022
00.103D-2	Right	2	5.0x	25 mm	0.022
00.103D-2.5	Right	2.5	4.0x	25 mm	0.022
00.103D-3	Right	3	3.5x	25 mm	0.022
00.103D-3.5	Right	3.5	3.0x	25 mm	0.022
00.103D-4	Right	4	2.5x	25 mm	0.022

Spare parts :

MSA	Item	Kg
00.100D-A1	Large right clip	0.005
00.100G-A1	Large left clip	0.005



See chapter PERF.



Clip-on spectacle eyeglasses.



MSA	Magnification	Ø lens	Kg
00.012-1	10x	15 mm	0.050
00.012-1.5	7x	24 mm	0.050
00.012-2	5x	24 mm	0.050
00.012-2.5	4x	24 mm	0.050
00.012-3.5	3x	24 mm	0.050

Lightweight simple lateral eyeglass for spectacles (right and left eye).
 Delivered in plastic case with a variety of fixing clamps for spectacle frames from 1.60 to 6.35 mm.



MSA	Magnifications	Ø lenses	Kg
00.013-01	5x - 10x - 15x	24 - 15 mm	0.050
00.013-03	5x - 7x - 12x	24 - 25 mm	0.050
00.013-02	4x - 10x - 14x	24 - 15 mm	0.050
00.013-04	4x - 7x - 11x	24 - 25 mm	0.050
00.013-05	3x - 7x - 10x	24 - 25 mm	0.050
00.013-06	3x - 5x - 8x	24 - 25 mm	0.050

Lightweight double lateral eyeglass for spectacles (right and left eye). Each model allows 3 different magnifications by combining the lenses.
 Delivered in a plastic case with a variety of fixing clamps for spectacle frames from 1.60 to 6.35 mm.

Safety spectacles.



See chapter 26.

Binocular magnifiers.



MSA	Magnifications	Kg
00.259	1.5x - 2.5x - 3.5x	0.085

Binocular magnifier with clip, adaptable to all types of spectacles.
Delivered in a cardboard box.



MSA	Magnification	Kg
00.256-3	3.0x	0.100
00.256-2.5	2.5x	0.100
00.256-2	2.0x	0.100

Binocular magnifier with plastic frame.
Suitable for people wearing spectacles.
Delivered in a plastic box with a cleaning cloth.

Spare parts :

MSA	Item	Kg
00.257-2	Binocular plate in acrylic resin 2.0x, 74 x 28 mm	0.012
00.257-2.5	Binocular plate in acrylic resin 2.5x, 74 x 28 mm	0.012
00.257-3	Binocular plate in acrylic resin 3.0x, 74 x 28 mm	0.012

ECOLINE



MSA	Magnifications	Kg
00.258	1.5x - 2.5x - 3.5x	0.174

Binocular magnifier on metal frame.
Suitable for people wearing optical glasses.
Delivered in a synthetic case with a cleaning cloth.

00.250-10



MSA	No.	Magnification	Focal length	Kg
00.250-10	10	3.50x	10.16 cm / 4"	0.240
00.250-07	7	2.75x	15.240 cm / 6"	0.240
00.250-05	5	2.50x	20.32 cm / 8"	0.240
00.250-04	4	2.00x	25.40 cm / 10"	0.240
00.250-03	3	1.75x	35.56 cm / 14"	0.240
00.250-02	2	1.50x	50.80 cm / 20"	0.240

Binocular magnifier with high quality mobile visor. Rounded edges, folding visor mounted on hinges, adjustable headband using button and comfortable front part furnished with leather doubled of felt. Can be worn over spectacles.

Spare parts :

MSA	Item	Kg
00.251-02	Binocular plate no. 2 (1.50x), 103 x 38 mm	0.031
00.251-03	Binocular plate no. 3 (1.75x), 103 x 38 mm	0.031
00.251-04	Binocular plate no. 4 (2.00x), 103 x 38 mm	0.031
00.251-05	Binocular plate no. 5 (2.50x), 103 x 38 mm	0.031
00.251-07	Binocular plate no. 7 (2.75x), 103 x 38 mm	0.031
00.251-10	Binocular plate no. 10 (3.50), 103 x 38 mm	0.031

Accessory :

MSA	Item	Kg
00.252	Auxiliary lens 2.50x, lentille Ø 36 mm. Can be mounted on both sides	0.020

ECO LINE



MSA	Magnifications	Size	Kg
00.245	1.2x - 1.8x - 2.5x - 3.5x	290 x 215 x 65 mm	0.500

Binocular magnifier with frontal lamp 2 LED, adjustable headband and folding ocular plate. Multiple adjustable positions for frontal lamp: about 25° to the left or right and 45° upwards or downwards. It functions with 2 AAA batteries included.

Delivered with a plastic case containing 4 interchangeable ocular plates in acrylic resin.

Spare part :

MSA	Item	Kg
00.245-B	Case with 4 ocular plates	0.205

Accessory :

PILE	Item	Kg
L92	Battery ENERGIZER AAA, blister 2 pieces	0.013

ECOLINE



MSA	Magnifications	Kg
00.242	1.8x - 2.3x - 3.7x - 4.8x	0.185

Non-reflecting binocular magnifier with multiple magnifications, folding internal lens and auxiliary lens. Headband with easy Velcro® attachment.



Spare part :

MSA	Item	Kg
00.242-A	Additional eyeglass 2.5x, Ø 30 mm	0.004

Control mirror.



MSA	Ø mirror	Length	Kg
00.280	30 mm	210 mm	0.022

Control mirror to inspect the difficult places of access, with hexagonal metal handle.

Triplet loupes.

ECOLINE



MSA	Magnification	Ø lenses	Kg
00.303	10x	18 mm	0.046

Triplet loupe for gem examination with 3 lenses, linked to obtain an increased, clear and very fine image. Inclusions of diamonds are definitely visible with this type of loupe. Chromed finish.

Delivered in a plastic box.

ECOLINE



MSA	Magnification	Ø lenses	Kg
00.304	20x	20.50 mm	0.056

Triplet loupe for gem examination with 3 lenses, linked to obtain an increased, clear and very fine image. Inclusions of diamonds are definitely visible with this type of loupe. Black plastic body and nickel-plated brass cover.

Delivered in a plastic box.

Hand and on stand loupes.

ECOLINE



MSA	Magnification	Ø lens	Length	Kg
00.512	15x	37 mm	132 mm	0.060

Hand control magnifying-glass with 2 LED lighting.

ECOLINE



MSA	Magnifications	Ø lenses	Length	Kg
00.506	2x - 6x	90 - 21 mm	360 mm	0.499

Magnifying-glass on stand with flexible arm and 2 LED lighting.

ECOLINE



MSA	Magnifications	Ø lenses	Length	Kg
00.507	2x - 6x	107 - 24 mm	360 mm	0.450

Magnifying-glass on stand with flexible arm and 2 LED lighting.

HOROTEC lamps by RMD.

SLIM LINE II Pro Line lamps with variable intensity.



The LED lamp with articulated arm of the Pro Line range is perfectly suitable for watchmakers, goldsmiths, as well as for all professions and hobbies with very high visual requirements.

- Compact and robust luminaire housing with a spring-supported articulated arm
- The 3D joint on the lamp head has a large adjustment range and, in conjunction with a smooth-running friction joint arm made of aluminium profile tube, provides a great deal of flexibility for working.

Technical data :

- Anti-stroboscopic effect
- Opaque white diffuser as standard
- Wide light distribution, direct lighting
- Homogeneous, large-area light by one row of LED-modules. Dimmable as standard
- Control gear electronic LED-driver (no separate power supply)
- Switch multifunctional push-button in articulated arm (ON/OFF/DIMMER)
- LED-lifetime up to 50'000 hours
- Protection class IP20
- Colour temperature : 5700 K
- Very high colour rendering : CRI > 95 (97)
- No IR and UV emission
- No heat emission in direction of the light ; working area remains cool and the lighting head remains lukewarm.



MSA	LED	Voltage	Power	Head size	Kg
00.675	48 LED	220-240 V / 50-60 Hz	24 W	58.6 x 11 x 3.6 cm	3.500
00.668	24 LED	220-240 V / 50-60 Hz	12 W	35.0 x 11 x 3.6 cm	3.500

Spare parts :

MSA	Item	Kg
00.659-B	Opaque white diffuser for MSA00.675 and MSA00.676	0.110
00.659-C	Prismatic diffuser for MSA00.675 and MSA00.676	0.065
00.660-B	Opaque white diffuser for MSA00.668	0.064
00.660-C	Prismatic diffuser for MSA00.668	0.044

Accessory :

MSA	Item	Kg
00.676-L	Additional eyeglass Ø 120 mm, 3.4 dioptres / magnification 1.9x	0.340



Maximum lightning strength at a distance of 50 cm (MSA00.675) :

- With opaque diffuser : CRI > 95 (97) - Temp. 5700 K - Emax = 2002 Lux
- With prismatic diffuser : CRI > 95 (97) - Temp. 5700 K - Emax = 3512 Lux

Maximum lightning strength at a distance of 50 cm (MSA00.668) :

- With opaque diffuser : CRI > 95 (97) - Temp. 5700 K - Emax = 1171 Lux
- With prismatic diffuser : CRI > 95 (97) - Temp. 5700 K - Emax = 2130 Lux

SLIM LINE III Premium Line ergonomic lamp with variable intensity.



This LED lamp with articulated arm of the Premium Line range impresses with its flexible and simple operation. It is therefore one of our most flexible LED articulated lamps.

- Thanks to an innovative gas pressure spring arm, the lamp head can be easily positioned without the use of a locking screw and can be tilted if required
- Excellent light quality is ensured by double-row Mid-Power LED modules, which provide sufficient light for every workplace.



- Technical data :**
- Anti-stroboscopic effect
 - Opaque white diffuser as standard
 - Parallelogram-arm with 2 integral gas pressure springs
 - Ergonomic arm with gas springs, easy to adjust for an ideal workstation
 - Continuously and flicker-free dimmable as standard, with memory function
 - Continuous, shadow-free, glare-free light
 - LED Modules: 96 daylight white midpower-LEDs (in 2 rows)
 - Colour temperature : 5700 K
 - Colour rendering : CRI >95 (97)
 - Protection class : IP20
 - LED-lifetime : 50'000 hours
 - No IR and UV emission
 - No heat emission in direction of the light, working area remains cool and the lighting head remains lukewarm
 - Switch multifunctional push-button in the lamp head (ON/OFF/DIMMER).

MSA	LED	Voltage	Power	Head size	Kg
00.676	96 LED	220-240 V / 50-60 Hz	22 W	58.6 x 11 x 3.6 cm	4.200

Spare parts :

MSA	Item	Kg
00.659-B	Opaque white diffuser for MSA00.675 and MSA00.676	0.110
00.659-C	Prismatic diffuser for MSA00.675 and MSA00.676	0.065

Accessory :

MSA	Item	Kg
00.676-L	Additional eyeglass Ø 120 mm, 3.4 diopres / magnification 1.9x	0.340



Maximum lightning strength at a distance of 50 cm :

With opaque diffuser : CRI > 95 (93) - Temp. 5700 K - 2153 Lux
 With prismatic diffuser : CRI > 95 (93) - Temp. 5700 K - 3915 Lux

Ergonomic arm with gas springs



PREMIUM LINE StepDim lamp.



HOROTEC PREMIUM LINE lamp with variable light intensity in steps of 50-60-70-80-90-100 % thanks to new Stepdim technology.

- Thanks to an arm equipped with an innovative gas pressure spring, the lamp head can be easily positioned without using a locking screw (can be tilted if necessary)
- CRI 97 / Daylight colour temperature 5400 K
- Maximum lightning strength at a distance of 50 cm : 12 W lamp (100% = 1235 Lux, 50 % approx. 700 Lux) and 22 W lamp (100% = 2150 Lux, 50 % approx. 1100 Lux).

MSA	LED	Voltage	Power	Head size	Kg
00.678	48 LED	220-240 V - 50-60 Hz	12 W-954	L 35.0 cm	5.640
00.679	96 LED	220-240 V - 50-60 Hz	22 W-954	L 58.6 cm	6.125

Maximum lightning strength at a distance of 50 cm :

- MSA00.678 : CRI = 97 - Temp. 5400 K - Emax = 1235 Lux (100%) ; 700 Lux (50%)
- MSA00.679 : CRI = 97 - Temp. 5400 K - Emax = 2150 Lux (100%) ; 1100 Lux (50%)



POWER LINE StepDim lamp.



HOROTEC POWER LINE lamp with variable light intensity in steps of 50-60-70-80-90-100 % thanks to new Stepdim technology.

- The 3D articulation of the head lamp has a large adjustment range and, combined with a friction arm made of profiled aluminium tube, offers great working flexibility
- CRI 97 / Daylight colour temperature 5400 K
- Maximum lightning strength at a distance of 50 cm : 12 W lamp (100% = 1235 Lux, 50 % approx. 700 Lux) and 22 W lamp (100% = 2150 Lux, 50 % approx. 1100 Lux).

MSA	LED	Voltage	Power	Head size	Kg
00.674	48 LED	220-240 V / 50-60 Hz	12 W-954	L 35.0 cm	4.575
00.687	96 LED	220-240 V / 50-60 Hz	22 W-954	L 58.6 cm	5.265

Maximum lightning strength at a distance of 50 cm :

- MSA00.674 : CRI = 97 - Temp. 5400 K - Emax = 1235 Lux (100%) ; 700 Lux (50%)
- MSA00.687 : CRI = 97 - Temp. 5400 K - Emax = 2150 Lux (100%) ; 1100 Lux (50%)



BASIC LINE lamp with fixed intensity.



LED lamp with articulated arm.

- Equipped with 24 white LED daylight, unvariable intensity
- Low power consumption
- No UV and infrared components in the light spectrum
- No stroboscopic effect
- Lamp colour : silver grey (RAL 9006)
- Opaque white diffuser as standard
- Colour temperature : 5000 K
- Colour rendering : CRI > 80 (84).

MSA	LED	Voltage	Power	Head size	Arms length	Kg
00.677	24 LED	220-240 V / 50-60 Hz	12 W	35.5 x 9.8 x 5 cm	Sup. 39 x Inf. 43 cm	4.365



Magnifying lamp.



Magnifying round LED lamp, 3 dioptries.

- Continuous dimming function from approximately 5% to 100% luminance
- 3 different lighting scenes for supporting different visual tasks
- (1) All segments ON : even and broad light pattern underneath the lens
- (2) Left + right segment ON for setting off structures, etc.
- (3) Rear segment only for strong "hi-lighting" effect
- Best colour rendering index : CRI >90
- Colour temperature 5000K supporting visual recognition of contrasts
- LED-lifetime : 50'000 hours
- Total power 12 W.

MSA	LED	Voltage	Dioptries/ Magnification	Head size	Arms length	Kg
00.667	48 LED	220-240 V / 50-60 Hz	3 / 175 %	Ø 31.3 cm	41.5 x 31.5 cm	3.500

Maximum lightning strength at a distance of 15 cm :

With opaque diffuser : CRI > 90 - Temp. 5300 K - Emax = 6000 Lux

Accessories for HOROTEC lamps.

Accessories for SLIM LINE II + III, PREMIUM LINE, POWER LINE, BASIC LINE and magnifying lamps.



MSA	Size	Kg
00.670	24 x 26.5 x 2 cm	10.250

Bench base to fix lamps without foot.



MSA	Size	Kg
00.671	22.3 x 22.3 x 2 cm	9.000

Bench base to fix lamps with foot and magnifying lamps.



MSA	Kg
00.672	0.133

Fitting base.



MSA	Size	Kg
00.673	80 x 85 mm	0.412

Wall angle.



MSA	Opening	Kg
00.657	0...44 mm	0.400
00.663	16...85 mm	0.600

Bench clamp.

WALDMANN lamps.

WALDMANN® universal lamps.



Universal lamp TANE0.

- Maintenance-free dimmable LED technology with 24 diodes
- Service life of up to 50,000 hours and more
- Requirements-oriented output levels for up to 3600 lx. 30 % energy saving
- Glare-free thanks to Conical Prismatic Screen (CDP) or white opal screen
- Flicker-free light with no IR or UV content
- Good contrast sensitivity and very good colour recognition thanks to premium LED
- Uniquely flexible and balanced arm with an enormous radius of action or intelligent connections for space-saving under-cabinet assembly
- Colour temperature neutral white 5000 K
- Touch panel integrated in the luminaire head for On/Off and dimming
- Table power supply and 3 metre connecting cable.

MSA	IRC > 90 LED	Voltage	Power	Head size	Arms length	Kg
00.650	24 LED	100-240 V / 50-60 Hz	24 W	39.8 x 13.6 x 3.3 cm	Sup. 38.4 cm Inf. 40.0 cm	4.100
00.653	24 LED	100-240 V / 50-60 Hz	24 W	39.8 x 13.6 x 3.3 cm	Sup. 24.4 cm Inf. 45.0 cm	4.100
00.654	*	24 LED	24 W	39.8 x 13.6 x 3.3 cm	Sup. 24.4 cm Inf. 45.0 cm	4.100

* Protected intensity adjustment

Accessories :

MSA	Item	Kg
00.650-L	(1) Additional eyeglass 110 x 60 mm, 4 dioptries	0.290
00.650-M	(2) Additional eyeglass Ø 132 mm, 3.5 dioptries	0.460



WALDMANN® magnifying lamps.

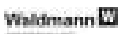

Magnifier lamp TEVISIO. It supports demanding viewing tasks with ergonomic perfection.

- Equipped with the latest LED technology. The multifunction button adjusts the light intensity and segment switching
- Easily adjustable arm which, if necessary, can be locked precisely if require
- Strength lightning power of 5500 lx at only 14 W
- Colour temperature neutral white 4000 K
- Integrated electronic ballast
- Maintenance-free : LED service life up to 50'000 hours
- Anti-reflective glass or plastic lens Ø 160 mm
- Wide field of view adapted ideally to the inter-ocular distance allowing a distortion-free viewing
- Index protection IP 20, protection class II
- Supplied with a 3.5 metre power cable.

MSA	Model	Voltage	Power	Dioptries	Arms length	Kg
00.652	Glass lens Ø 160 mm 3D articulation (head)	100-240 V / 50-60 Hz	14 W	3.5	Sup. 38.4 cm Inf. 40.0 cm	4.200
00.685	Anti-reflective glass lens Ø 160 mm 3D articulation (head)	100-240 V / 50-60 Hz	14 W	3.5	Sup. 38.4 cm Inf. 40.0 cm	4.200
00.686	Plastic lens Ø 160 mm 2D articulation (head)	100-240 V / 50-60 Hz	14 W	3.5	Sup. 38.4 cm Inf. 40.0 cm	4.200

Accessories for WALDMANN lamps.

WALDMANN® universal lamps.



MSA	Opening	Kg
00.608-A	0...45 mm	0.700
00.608-B	0...65 mm	0.500
00.608-C	65...135 mm	0.500
00.608-D	95...165 mm	0.500

Black bench clamp TK1.



MSA	Size	Kg
00.627	300 x 200 x 70 mm	7.000

Grey bench base.



MSA	Size	Kg
00.617-B	80 x 90 x 40 mm	0.122

Standard fitting base for lamps type SN/SNE.



MSA	Size	Kg
00.621	105 x 160 mm	1.200

Adaptable magnifier 3 dioptres for lamps type SN(E) 118/136.



MSA	Size	Kg
00.655	100 x 50 mm	0.210

Magnifying glass with steel supports adapted to the head of the SN/SNE lamps.

ECOLINE lamps.

ECOLINE



Head size : 61 x 11 cm

MSA	Voltage	Arms length	Kg
00.646	220 V	45 x 45 cm	3.400

Bench lamp.

- 2 articulated arms
- 3 fluorescent tubes 15 W, daylight
- Parabolic grid
- Electronic ballast
- Fixing clamp.

Spare part :

MSA	Item	Kg
00.646-A	Fluorescent tube 15 W, daylight	0.055

ECOLINE



Head size : 58 x 8 cm

MSA	Voltage	Power	Arms length	Kg
00.649	110 - 220 V	21 W	47 x 45 cm	3.200

Bench lamp.

- 2 articulated arms in white lacquered steel, mast 47 cm and arm 45 cm
- Lighting with 84 LED, light intensity adjustable by multifunction button
- Luminous flux 1300 lm
- Integrated electronic ballast
- Fixing with a universal clamp.

UV lamps.

PRECITEC



MSA	Size	Kg
00.682	Ø 13 x 125 mm	0.033

UV lamp (pen light) for controlling fluorescent oils.
Light colour : blue/violet. 395 Nm.

Works with 2 AAA batteries (not included).

Accessory :

PILE	Item	Kg
L92	Battery ENERGIZER AAA, blister 2 pieces	0.013

PRECITEC



MSA	Size	Kg
00.683	Ø 25 x 140 mm	0.215

UV flashlight for controlling fluorescent oils and detecting dust.
Light colour : white. 365 Nm.

Delivered with 1 rechargeable battery MSA00.683-A and 1 charger.

Spare part :

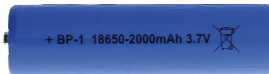

MSA	Item	Kg
00.683-A	Rechargeable battery, 3.7 V / 2000 mAh	0.045

PRECITEC



MSA	Size	Kg
00.684	220 x 150 x 295 mm	1.555

UV flashlight MSA00.683 mounted on an adjustable stand for controlling fluorescent oils and detecting dust.
Light colour : white. 365 Nm.



MSA	Size	Kg
00.690	-	0.130

The Moebius® LUBETRACKER is an eye-safe visual aid for checking fluorescent lubrication points.

Advantages :

- Easy visualization of Moebius fluorescent lubricants (example: 9010-FL, 9104-FL, 8200-FL, etc.)
- No UV light harmful to the eyes (white light only)
- No need for expensive equipment with UV filter
- Using your own watchmaker's eyeglass
- Compact, easy to carry and to store.

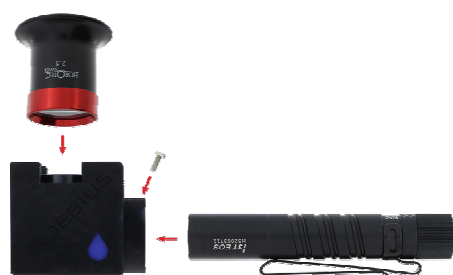

Preparation before use

01

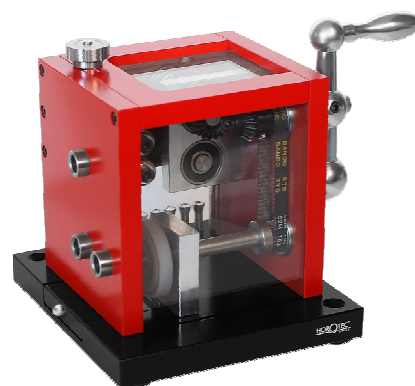

ALUMINIUM HOROTEC® SCREWDRIVERS, STANDARD BLADES	01 - 2
STAINLESS STEEL HOROTEC® SCREWDRIVERS, STANDARD BLADES	01 - 5
STAINLESS STEEL HOROTEC® SCREWDRIVERS, "T" SHAPE BLADES	01 - 9
ST. STEEL HOROTEC® SCREWDRIVERS, PHILLIPS BLADES / LARGE SCREWDRIVER	01 - 10
CHROMED BRASS CLASSIC SCREWDRIVERS, STANDARD BLADES	01 - 11
CHROMED BRASS CLASSIC SCREWDRIVERS, ANTIMAGNETIC BLADES	01 - 14
SPECIAL SCREWDRIVERS	01 - 16
TOOLS FOR SHAPING AND SHARPENING BLADES	01 - 20

ALUMINIUM HOROTEC® SCREWDRIVERS, STANDARD BLADES

WATCHMAKER screwdrivers. Knurled anodised ALUMINIUM handle, ergonomic head in black POM and interchangeable stainless steel blade.



MSA	Ø blades	Kg
01.020-C	0.50 - 0.60 - 0.80 - 1.00 - 1.20 - 1.40 - 1.60 - 2.00 - 2.50 - 3.00 mm	0.270

Assortment of 10 watchmaker screwdrivers MSA01.020-xxx :

- Turning stand
- Non-skid base
- Colour coded hole for fast identification.

Delivered with 10 stainless steel spare blades MSA01.215-xxx stored in the central compartment of the stand.

ASSORTMENT



MSA	Ø blades	Kg
01.020-E	0.60 - 0.80 - 1.00 - 1.20 - 1.40 - 1.60 - 2.00 - 2.50 - 3.00 mm	0.227

Assortment of 9 watchmaker screwdrivers MSA01.020-xxx.

Livré dans 1 coffret en bois avec 9 mèches de rechange MSA01.215-xxx en acier inoxydable et 2 vis de fixation MSA01.218-V.

ASSORTMENT



MSA	Ø blades	Kg
01.020-F	0.60 - 0.80 - 1.00 - 1.20 mm	0.029
01.020-G	0.80 - 1.00 - 1.20 - 1.40 mm	0.029

Assortment of 4 watchmaker screwdrivers MSA01.020-xxx.

Delivered in 1 plastic pouch.

ASSORTMENT



ASSORTMENT

MSA	Ø blades	Kg
01.020-A	0.60 - 0.80 - 1.00 - 1.20 - 1.40 mm	0.111

Assortment of 5 watchmaker screwdrivers MSA01.020-xxx.
Delivered in a plastic box with foam cut-out.



ASSORTMENT

MSA	Ø blades	Kg
01.020-B	1.00 - 1.20 - 1.40 - 1.60 - 2.00 mm	0.116

Assortment of 5 watchmaker screwdrivers MSA01.020-xxx.
Delivered in a plastic box with foam cut-out.



ASSORTMENT

MSA	Ø blades	Kg
01.020-D	0.80 - 1.00 - 1.20 - 1.40 - 1.60 mm	0.114

Assortment of 5 watchmaker screwdrivers MSA01.020-xxx.
Delivered in a plastic box with foam cut-out.

ALUMINIUM HOROTEC® SCREWDRIVERS, STANDARD BLADES



MSA	Ø blades	Model	Kg
01.020-050	0.50 mm	Orange	0.007
01.020-060	0.60 mm	Natural	0.007
01.020-080	0.80 mm	Yellow	0.007
01.020-100	1.00 mm	Black	0.020
01.020-120	1.20 mm	Red	0.020
01.020-140	1.40 mm	Dark grey	0.020
01.020-160	1.60 mm	Violet	0.020
01.020-200	2.00 mm	Green	0.020
01.020-250	2.50 mm	Blue	0.020
01.020-300	3.00 mm	Brown	0.020

Watchmaker screwdriver.

- Knurled anodised aluminium handle
- Ergonomic head in black POM
- Interchangeable stainless steel blade.

Delivered individually in a pouch with mounted blade.



Antimagnetic blades, see page 01-13.

MSA	Ø	Kg	MSA	Ø	Kg
01.215-050	0.50 mm	0.001	01.215-140	1.40 mm	0.003
01.215-060	0.60 mm	0.003	01.215-150	1.50 mm	0.003
01.215-070	0.70 mm	0.003	01.215-160	1.60 mm	0.003
01.215-080	0.80 mm	0.003	01.215-180	1.80 mm	0.003
01.215-090	0.90 mm	0.003	01.215-200	2.00 mm	0.003
01.215-100	1.00 mm	0.003	01.215-250	2.50 mm	0.003
01.215-110	1.10 mm	0.003	01.215-300	3.00 mm	0.003
01.215-120	1.20 mm	0.003	01.215-350	3.50 mm	0.003
01.215-130	1.30 mm	0.003			

Stainless steel interchangeable blade for watchmaker screwdrivers MSA01.020-xxx. Hardness 54 ± 2 HRC.



MSA	Ø blades	Kg
01.201-M	2x 0.50 - 0.60 - 0.70 - 0.80 - 1.00 mm	0.065

Plastic tube containing 21 stainless steel blades MSA01.215-xxx for watchmaker screwdrivers MSA01.020-xxx. Hardness 54 ± 2 HRC.



MSA	Kg
01.218-V	0.001

Spare screws for :

- Watchmaker screwdrivers MSA01.020-xxx.

The absolutely best WATCHMAKER screwdrivers ! Knurled STAINLESS STEEL handle, hexagonal swivel large diameter head mounted on ball bearings and interchangeable stainless steel blade.



MSA	Ø blades	Kg
01.218-E	0.50 - 0.60 - 0.70 - 0.80 - 1.00 - 1.20 - 1.40 - 1.50 - 1.60 - 2.00 - 2.50 - 3.00 mm	0.820

Assortment of 12 watchmaker screwdrivers MSA01.218-xxx :
 - Turning stand in solid aluminium with ball bearing
 - Non-skid base
 - Colour coded holes for fast identification.

Delivered with 21 stainless steel spare blades MSA01.215-xxx stored in the central compartment of the stand.

Stand size : Ø 90 x height 41 mm.

ASSORTMENT



MSA	Ø blades	Kg
01.218-C	0.60 - 0.80 - 1.00 - 1.20 - 1.40 - 1.60 - 2.00 - 2.50 mm	0.406

Assortment of 8 watchmaker screwdrivers MSA01.218-xxx :
 - Turning stand in solid aluminium
 - Non-skid base.

Delivered with 8 stainless steel spare blades MSA01.215-xxx stored in the central compartment of the stand.

Stand size : Ø 60 x height 39 mm.

ASSORTMENT



MSA	Ø blades	Kg
01.218-D	0.60 - 0.80 - 1.00 - 1.20 - 1.40 - 2.00 mm	0.293

Assortment of 6 watchmaker screwdrivers MSA01.218-xxx :
 - Sturdy aluminium stand
 - 6 coloured heads for quick identification.

Delivered with 6 stainless steel spare blades MSA01.215-xxx.

Stand size : 110 x 35 x 36 mm.

ASSORTMENT

STAINLESS STEEL HOROTEC® SCREWDRIVERS, STANDARD BLADES



ASSORTMENT

MSA	Ø blades	Kg
01.218-A	0.60 - 0.80 - 1.00 - 1.20 - 1.40 - 1.60 - 2.00 - 2.50 - 3.00 mm	0.242

Assortment of 9 watchmaker screwdrivers MSA01.218-xxx.
Delivered in a wooden case with 9 stainless steel spare blades MSA01.215-xxx and 2 fixing screws MSA01.218-V.



MSA	Ø blades	Head colour	Kg
01.218-050	0.50 mm	Orange	0.020
01.218-060	0.60 mm	Light grey	0.020
01.218-070	0.70 mm	Dark blue	0.020
01.218-080	0.80 mm	Yellow	0.020
01.218-090	0.90 mm	Rose	0.020
01.218-100	1.00 mm	Black	0.020
01.218-110	1.10 mm	Pastel yellow	0.020
01.218-120	1.20 mm	Red	0.020
01.218-130	1.30 mm	Light green	0.020
01.218-140	1.40 mm	Dark grey	0.020
01.218-150	1.50 mm	Salmon	0.020
01.218-160	1.60 mm	Violet	0.020
01.218-180	1.80 mm	Orange	0.020
01.218-200	2.00 mm	Green	0.020
01.218-250	2.50 mm	Blue	0.020
01.218-300	3.00 mm	Brown	0.020

Watchmaker screwdriver.
- Knurled stainless steel handle
- Hexagonal swivel large diameter anodized aluminium head mounted on ball bearings
- Interchangeable stainless steel blade.
Delivered individually with screwed blade.



Antimagnetic blades, see page 01-13.

MSA	Ø	Kg	MSA	Ø	Kg
01.215-050	0.50 mm	0.001	01.215-140	1.40 mm	0.003
01.215-060	0.60 mm	0.003	01.215-150	1.50 mm	0.003
01.215-070	0.70 mm	0.003	01.215-160	1.60 mm	0.003
01.215-080	0.80 mm	0.003	01.215-180	1.80 mm	0.003
01.215-090	0.90 mm	0.003	01.215-200	2.00 mm	0.003
01.215-100	1.00 mm	0.003	01.215-250	2.50 mm	0.003
01.215-110	1.10 mm	0.003	01.215-300	3.00 mm	0.003
01.215-120	1.20 mm	0.003	01.215-350	3.50 mm	0.003
01.215-130	1.30 mm	0.003			

Stainless steel interchangeable blade for watchmaker screwdrivers MSA01.218-xxx. Hardness 54 ± 2 HRC.
See assortment MSA01.201-M with 21 blades on page 01-3.



MSA	Kg
01.218-V	0.001

Spare screws for :
- Watchmaker screwdrivers MSA01.218-xxx
- Enlargement rings MSA01.218-Txxx.

STAINLESS STEEL HOROTEC® SCREWDRIVERS, STANDARD BLADES



MSA	Model	Ø	Use with	Kg
01.218-T450	Small	4.50 mm	Screwdriver Ø 0.50...1.50 mm	0.002
01.218-T500	Medium	5.00 mm	Screwdriver Ø 1.60...2.00 mm	0.002
01.218-T550	Large	5.50 mm	Screwdriver Ø 2.50...3.00 mm	0.002

Aluminium enlargement ring for watchmaker screwdrivers, allowing better grip for screwing and unscrewing.
Size : Ø 8 x length 20 mm.



MSA		Ø blades	Head colour	Kg
01.219-050		0.50 mm	Orange	0.023
01.219-060		0.60 mm	Light grey	0.023
01.219-070		0.70 mm	Dark blue	0.023
01.219-080		0.80 mm	Yellow	0.023
01.219-090		0.90 mm	Rose	0.023
01.219-100		1.00 mm	Black	0.023
01.219-110		1.10 mm	Pastel yellow	0.023
01.219-120		1.20 mm	Red	0.023
01.219-130		1.30 mm	Light green	0.023
01.219-140		1.40 mm	Dark grey	0.023
01.219-150		1.50 mm	Salmon	0.023
01.219-160		1.60 mm	Violet	0.023
01.219-180		1.80 mm	Orange	0.023
01.219-200		2.00 mm	Green	0.023
01.219-250		2.50 mm	Blue	0.023
01.219-300		3.00 mm	Brown	0.023

Watchmaker screwdriver MSA01.218-xxx.
Delivered in 1 plastic pouch with 1 tube containing 3 stainless steel blades.



MSA	Ø blades	Kg
01.216-050	0.50 mm	0.003
01.216-060	0.60 mm	0.003
01.216-070	0.70 mm	0.003
01.216-080	0.80 mm	0.003
01.216-090	0.90 mm	0.003
01.216-100	1.00 mm	0.003
01.216-110	1.10 mm	0.003
01.216-120	1.20 mm	0.003
01.216-130	1.30 mm	0.003
01.216-140	1.40 mm	0.003
01.216-150	1.50 mm	0.003
01.216-160	1.60 mm	0.003
01.216-180	1.80 mm	0.003
01.216-200	2.00 mm	0.003
01.216-250	2.50 mm	0.003
01.216-300	3.00 mm	0.003
01.216-350	3.50 mm	0.003

Plastic tube containing 3 stainless steel blades for watchmaker screwdrivers MSA01.218-xxx.
Other Ø and shapes available upon request and according to quantities.

STAINLESS STEEL HOROTEC® SCREWDRIVERS, STANDARD BLADES



MSA	Ø blades	Kg
01.218-G	0.60 - 0.80 - 1.00 - 1.20 mm	0.080

Assortment of 4 watchmaker screwdrivers MSA01.218-xxx.
Delivered in 1 plastic pouch.

ASSORTMENT



MSA	Ø blades	Kg
01.218-B	0.60 - 0.80 - 1.00 - 1.20 - 1.40 mm	0.100

Assortment of 5 watchmaker screwdrivers MSA01.218-xxx.
Delivered in 1 plastic pouch.

ASSORTMENT



MSA	Ø blades	Kg
01.218-F	1.00 - 1.20 - 1.40 - 1.60 - 2.00 mm	0.100

Assortment of 5 watchmaker screwdrivers MSA01.218-xxx.
Delivered in 1 plastic pouch.

ASSORTMENT



MSA	Ø blades	Kg
01.218-H	0.60 - 0.80 - 1.00 - 1.20 - 1.60 - 2.50 mm	0.120

Assortment of 6 watchmaker screwdrivers MSA01.218-xxx.
Delivered in 1 plastic pouch.

ASSORTMENT

STAINLESS STEEL HOROTEC® SCREWDRIVERS, "T" SHAPE BLADES



MSA	Ø blades	Kg
01.214	0.60 - 0.70 - 0.80 - 1.00 - 1.20 - 1.40 - 1.50 - 1.60 - 1.80 - 2.00 mm	0.210

Assortment of 10 watchmaker screwdrivers MSA01.214-xxx.
Delivered in a plastic box with 10 "T" shaped stainless steel spare blades MSA01.220-xxx and 2 fixing screws MSA01.218-V.



ASSORTMENT

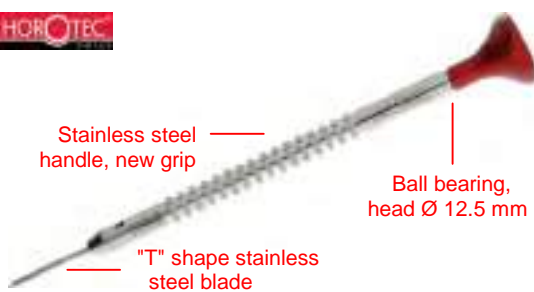

MSA	Head colour	Ø blades	Kg
01.214-050	Orange	0.50 mm	0.020
01.214-060	Light grey	0.60 mm	0.020
01.214-070	Dark blue	0.70 mm	0.020
01.214-080	Yellow	0.80 mm	0.020
01.214-090	Rose	0.90 mm	0.020
01.214-100	Black	1.00 mm	0.020
01.214-110	Pastel yellow	1.10 mm	0.020
01.214-120	Red	1.20 mm	0.020
01.214-130	Light green	1.30 mm	0.020
01.214-140	Dark grey	1.40 mm	0.020
01.214-150	Salmon	1.50 mm	0.020
01.214-160	Violet	1.60 mm	0.020
01.214-180	Orange	1.80 mm	0.020
01.214-200	Dark green	2.00 mm	0.020

Watchmaker screwdriver.
- Knurled stainless steel handle
- Hexagonal swivel large diameter anodized aluminium head mounted on ball bearings
- Interchangeable "T" shape stainless steel blade.
Delivered individually with screwed blade.

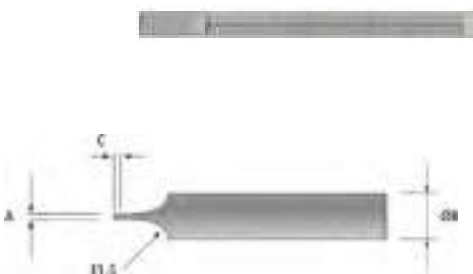

* hardened-blue steel

MSA	A	Ø B	C	Length	Kg
01.220-050	0.10 mm	0.50 mm	0.15 mm	18 mm	0.003
01.220-060	0.12 mm	0.60 mm	0.15 mm	18 mm	0.003
01.220-070	0.14 mm	0.70 mm	0.18 mm	18 mm	0.003
01.220-080	0.14 mm	0.80 mm	0.18 mm	18 mm	0.003
01.220-090	0.14 mm	0.90 mm	0.18 mm	18 mm	0.003
01.220-100	0.14 mm	1.00 mm	0.18 mm	21 mm	0.003
01.220-110	0.14 mm	1.10 mm	0.18 mm	21 mm	0.003
01.220-120	0.14 mm	1.20 mm	0.18 mm	21 mm	0.003
01.220-130	0.16 mm	1.30 mm	0.20 mm	21 mm	0.003
01.220-140	0.16 mm	1.40 mm	0.20 mm	23 mm	0.003
01.220-150	0.16 mm	1.50 mm	0.20 mm	23 mm	0.003
01.220-160	0.16 mm	1.60 mm	0.20 mm	23 mm	0.003
01.220-180	0.20 mm	1.80 mm	0.25 mm	23 mm	0.003
01.220-200	0.20 mm	2.00 mm	0.25 mm	25 mm	0.003
01.202-T250 *	-	2.50 mm	-	25 mm	0.001
01.202-T300 *	-	3.00 mm	-	25 mm	0.001

Stainless steel interchangeable "T" shape blade for watchmaker screwdrivers MSA01.214-xxx. Hardness 54 ± 2 HRC.

ST. STEEL HOROTEC® SCREWDRIVERS, PHILLIPS BLADES / LARGE SCREWDRIVER



MSA	Head colour	Ø blades	Kg
01.418-120	Red	1.20 mm	0.014
01.418-150	Salmon	1.50 mm	0.014
01.418-200	Green	2.00 mm	0.014
01.418-250	Blue	2.50 mm	0.017
01.418-300	Brown	3.00 mm	0.017

Watchmaker screwdriver with Phillips blade.
 - Knurled stainless steel handle
 - Hexagonal swivel large diameter anodized aluminium head mounted on ball bearings
 - Interchangeable stainless steel Phillips blade.
Delivered individually with screwed blade.



MSA	Ø	Kg
01.403-1.2	1.20 mm	0.001
01.403-1.5	1.50 mm	0.001
01.403-2.0	2.00 mm	0.001
01.403-2.5	2.50 mm	0.002
01.403-3.0	3.00 mm	0.002

Stainless steel interchangeable Phillips blade for watchmaker screwdrivers MSA01.404-x.x. Hardness 54 ± 2 HRC.



MSA	Ø blades	Kg
01.418	1.20 - 1.50 - 2.00 - 2.50 - 3.00 mm	0.061

Assortment of 5 watchmaker screwdrivers with Phillips blade MSA01.418-xxx.
Delivered in 1 plastic pouch.

ASSORTMENT

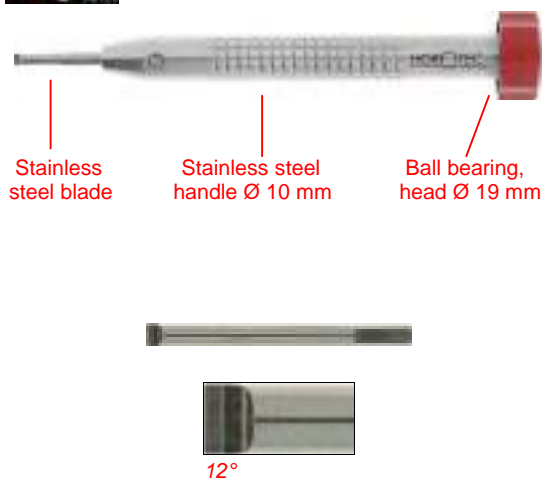

MSA	Ø blades	Kg
01.018-150	1.50 mm	0.066
01.018-200	2.00 mm	0.066
01.018-250	2.50 mm	0.066
01.018-300	3.00 mm	0.066

Large watchmaker screwdriver.
 - Knurled stainless steel handle Ø 10 mm, length 95 mm
 - Swivel large diameter (Ø 19 mm) anodized aluminium red head mounted on ball bearings and interchangeable stainless steel blade.
Delivered individually with screwed blade.

Spare parts :

MSA	Item	Kg
01.019-150	Blade Ø 1.50 mm, length 37 mm, body Ø 3 mm	0.002
01.019-200	Blade Ø 2.00 mm, length 37 mm, body Ø 3 mm	0.002
01.019-250	Blade Ø 2.50 mm, length 37 mm, body Ø 3 mm	0.002
01.019-300	Blade Ø 3.00 mm, length 37 mm, body Ø 3 mm	0.002

CHROMED BRASS CLASSIC SCREWDRIVERS, STANDARD BLADES

Classic precision screwdrivers. Knurled handle in chromed brass ; the head is equipped with a coloured ring indicating the diameter of the blade.



ASSORTMENT

MSA	Ø blades	Kg
01.100	0.60 - 0.80 - 1.00 - 1.20 - 1.40 - 1.60 - 2.00 - 2.50 - 3.00 mm	0.342

Assortment of 9 classic precision screwdrivers MSA01.101xxx :
- Chromed turning stand
- Non-skid base.

Delivered with 19 hardened-blue steel spare blades MSA01.102-xxx and 2 fixing screws MSA01.101-V stored in the central compartment of the stand.



ASSORTMENT

MSA	Ø blades	Kg
01.300	0.60 - 0.80 - 1.00 - 1.20 - 1.40 - 1.60 - 2.00 - 2.50 - 3.00 mm	0.258

Assortment of 9 classic precision screwdrivers MSA01.101xxx.

Delivered in a wooden box with 19 hardened-blue steel spare blades MSA01.102-xxx and 2 fixing screws MSA01.101-V in a plastic tube.



MSA	Ring colour	Ø blades	Kg
01.101-050	Dark green	0.50 mm	0.010
01.101-060	Rose	0.60 mm	0.010
01.101-080	Yellow	0.80 mm	0.010
01.101-100	Black	1.00 mm	0.015
01.101-120	Red	1.20 mm	0.016
01.101-140	Grey	1.40 mm	0.016
01.101-160	Violet	1.60 mm	0.020
01.101-180	Orange	1.80 mm	0.020
01.101-200	Light green	2.00 mm	0.023
01.101-250	Blue	2.50 mm	0.028
01.101-300	Brown	3.00 mm	0.030

Classic precision screwdriver.

- Knurled handle in chromed brass
- Head equipped with a coloured ring indicating the diameter of the blade
- Interchangeable hardened-blue steel blade.

Delivered individually with screwed blade.

CHROMED BRASS CLASSIC SCREWDRIVERS, STANDARD BLADES



MSA	Ring colour	Ø blades	Kg
01.099-050	Dark green	0.50 mm	0.012
01.099-060	Rose	0.60 mm	0.012
01.099-080	Yellow	0.80 mm	0.012
01.099-100	Black	1.00 mm	0.017
01.099-120	Red	1.20 mm	0.017
01.099-140	Grey	1.40 mm	0.017
01.099-160	Violet	1.60 mm	0.022
01.099-180	Orange	1.80 mm	0.022
01.099-200	Light green	2.00 mm	0.022
01.099-250	Blue	2.50 mm	0.030
01.099-300	Brown	3.00 mm	0.032

Classic precision screwdriver MSA01.101-xxx.

Delivered in 1 plastic pouch with 1 tube containing 3 hardened-blue steel blades.



MSA	Ø	Kg
01.215-050 *	0.50 mm	0.001
01.102-060	0.60 mm	0.001
01.102-080	0.80 mm	0.001
01.102-100	1.00 mm	0.001
01.102-120	1.20 mm	0.001
01.102-140	1.40 mm	0.001
01.102-160	1.60 mm	0.001
01.102-180	1.80 mm	0.001
01.102-200	2.00 mm	0.001
01.102-250	2.50 mm	0.001
01.102-300	3.00 mm	0.001

* *stainless steel*

Interchangeable hardened-blue steel blade for classic precision screwdrivers MSA01.101-xxx.



MSA	Ø blades	Kg
01.216-050 *	0.50 mm	0.003
01.103-060	0.60 mm	0.003
01.103-080	0.80 mm	0.003
01.103-100	1.00 mm	0.003
01.103-120	1.20 mm	0.003
01.103-140	1.40 mm	0.003
01.103-160	1.60 mm	0.003
01.103-180	1.80 mm	0.003
01.103-200	2.00 mm	0.003
01.103-250	2.50 mm	0.003
01.103-300	3.00 mm	0.003

* *stainless steel*

Plastic tube containing 3 hardened-blue steel blades for classic precision screwdrivers MSA01.101-xxx.



MSA	Kg
01.101-V	0.001

Screws for classic precision screwdrivers MSA01.101-xxx.

CHROMED BRASS CLASSIC SCREWDRIVERS, STANDARD BLADES



ASSORTMENT

MSA	Ø blades	Kg
01.003	0.60 - 0.80 - 1.00 - 1.20 mm	0.049

Assortment of 4 classic precision screwdrivers MSA01.101-xxx.
Delivered in 1 plastic pouch.



ASSORTMENT

MSA	Ø blades	Kg
01.095	0.60 - 0.80 - 1.00 - 1.20 - 1.40 mm	0.057

Assortment of 5 classic precision screwdrivers MSA01.101-xxx.
Delivered in 1 plastic pouch.



ASSORTMENT

MSA	Ø blades	Kg
01.095-Z	0.60 - 0.80 - 1.00 - 1.20 - 1.40 mm	0.060

Assortment of 5 classic precision screwdrivers MSA01.101-xxx and 5 interchangeable blades MSA01.102.xxx.
Delivered in 1 plastic pouch.



ASSORTMENT

MSA	Ø blades	Kg
01.013	0.60 - 0.80 - 1.00 - 1.20 - 2.00 - 3.00 mm	0.091

Assortment of 6 classic precision screwdrivers MSA01.101-xxx.
Delivered in 1 plastic pouch.

CHROMED BRASS CLASSIC SCREWDRIVERS, ANTIMAGNETIC BLADES

Precision classic screwdrivers. Knurled handle in chromed brass, anodised aluminium black head equipped with a coloured ring to indicate the blade diameter.
The interchangeable blades made of copper-beryllium alloy (CuBe) are 100% antimagnetic.



ANTIMAGNETIC ASSORTMENT

MSA	Ø blades	Kg
01.104	0.60 - 0.80 - 1.00 - 1.20 - 1.40 - 1.60 - 2.00 - 2.50 - 3.00 mm	0.340

Assortment of 9 precision antimagnetic screwdrivers MSA01.105-xxx :
- Chromed turning stand
- Non-skid base.

Delivered with 19 spare blades MSA01.106-xxx made of copper-beryllium alloy (CuBe) and 2 fixing screws MSA01.101-V stored in the central compartment of the stand.



ANTIMAGNETIC

MSA	Ring colour	Ø blades	Kg
01.105-050	Dark green	0.50 mm	0.010
01.105-060	Rose	0.60 mm	0.010
01.105-080	Yellow	0.80 mm	0.010
01.105-100	Black	1.00 mm	0.015
01.105-120	Red	1.20 mm	0.015
01.105-140	Grey	1.40 mm	0.015
01.105-160	Violet	1.60 mm	0.020
01.105-200	Light green	2.00 mm	0.020
01.105-250	Blue	2.50 mm	0.028
01.105-300	Brown	3.00 mm	0.030

Precision antimagnetic screwdriver.

- Knurled handle in chromed brass
- Head equipped with a coloured ring indicating the diameter of the blade
- Interchangeable blade made of copper-beryllium alloy (CuBe).

Delivered individually with screwed blade.



ANTIMAGNETIC

MSA	Ø	Kg	MSA	Ø	Kg
01.106-050	0.50 mm	0.001	01.106-140	1.40 mm	0.001
01.106-060	0.60 mm	0.001	01.106-160	1.60 mm	0.001
01.106-080	0.80 mm	0.001	01.106-200	2.00 mm	0.001
01.106-100	1.00 mm	0.001	01.106-250	2.50 mm	0.001
01.106-120	1.20 mm	0.001	01.106-300	3.00 mm	0.001

Interchangeable antimagnetic blade made of copper-beryllium alloy (CuBe).
Fits all types of screwdrivers with interchangeable blades.



MSA	Kg
01.101-V	0.001

Screws for precision antimagnetic screwdrivers MSA01.105-xxx.

Bag of 10 pieces.



**ANTIMAGNETIC
ASSORTMENT**

MSA	Ø blades	Kg
01.004	0.60 - 0.80 - 1.00 - 1.20 mm	0.051

Assortment of 4 precision antimagnetic screwdrivers MSA01.105-xxx.
Delivered in 1 plastic pouch.



**ANTIMAGNETIC
ASSORTMENT**

MSA	Ø blades	Kg
01.014	0.60 - 0.80 - 1.00 - 1.20 - 2.00 - 3.00 mm	0.090

Assortment of 6 precision antimagnetic screwdrivers MSA01.105-xxx.
Delivered in 1 plastic pouch with 1 tube containing 6 antimagnetic blades.

SPECIAL SCREWDRIVERS

SPECIAL screwdriver with fixed key of varied shapes. Knurled handle in chromed brass ; coloured identified heads indicating the diameter or the width of the key. The hole in the upper part of the handle allows the tool to be suspended or the insertion of a tightening stem. The fabrication and the heat-treatment of the keys are particularly neat to assure a good resistance.



MSA	Ring colour	Length	Internal width	Kg
01.107-A	Grey	107 mm	3.00 mm	0.026
01.107-B	Violet	107 mm	3.50 mm	0.026
01.107-C	Green	107 mm	4.00 mm	0.026
01.107-D	Blue	107 mm	4.50 mm	0.026
01.107-E	Brown	107 mm	5.00 mm	0.026

Special screwdriver with fixed female key for hexagonal nuts.
- Knurled handle in chromed brass.



MSA	Internal width	Kg
01.107-05	3.00 - 3.50 - 4.00 - 4.50 - 5.00 mm	0.125

Assortment of 5 special screwdrivers with fixed female key MSA01.107-x.
Delivered in 1 plastic pouch.

ASSORTMENT



MSA	Ring colour	Length	External width	Kg
01.108-1.5	Violet	107 mm	1.50 mm	0.025
01.108-2	Green	107 mm	2.00 mm	0.025
01.108-2.5	Blue	107 mm	2.50 mm	0.025
01.108-3	Brown	107 mm	3.00 mm	0.025

Special screwdriver with fixed male ALLEN type key for hexagonal hollow nuts.
- Knurled handle in chromed brass.



MSA	External width	Kg
01.008	1.50 - 2.00 - 2.50 - 3.00 mm	0.085

Assortment of 4 special screwdrivers with fixed male ALLEN type key MSA01.108-x.
Delivered in 1 plastic pouch.

ASSORTMENT



MSA	Ring colour	Ø blades	Kg
01.400-1.2	Grey	1.20 mm	0.026
01.400-1.5	Violet	1.50 mm	0.027
01.400-2.0	Green	2.00 mm	0.028
01.400-2.5	Blue	2.50 mm	0.029
01.400-3.0	Brown	3.00 mm	0.030

Special screwdriver with fixed cruciform PHILLIPS type blade.
- Knurled handle in chromed brass.



MSA	Ø blades	Kg
01.400-A	1.50 - 2.00 - 2.50 - 3.00 mm	0.093

Assortment of 4 special screwdrivers with fixed cruciform PHILLIPS type blade MSA01.400-x.
Delivered in 1 plastic pouch.

ASSORTMENT



MSA	Ø blades	Kg
01.400-B	1.20 - 1.50 - 2.00 - 2.50 - 3.00 mm	0.115

Assortment of 5 special screwdrivers with fixed cruciform PHILLIPS type blade MSA01.400-x.
Delivered in 1 plastic pouch.

ASSORTMENT

SPECIAL SCREWDRIVERS

Practical screwdrivers with **REVERSIBLE BLADE**. This system allows the user to easily reverse the blade using a threaded ferrule to replace it. Grooved handle in chromed brass, coloured head and interchangeable special steel blade ground at both ends.



MSA		Ø blades	Head colour	Length	Kg
01.221-060		0.60 mm	Blue	80 mm	0.012
01.221-070		0.70 mm	Grey	80 mm	0.012
01.221-080		0.80 mm	Red	80 mm	0.012
01.221-100		1.00 mm	Brown	80 mm	0.012
01.221-120		1.20 mm	Green	80 mm	0.012
01.221-130		1.30 mm	Black	80 mm	0.012
01.221-150		1.50 mm	Orange	80 mm	0.012

Screwdriver with reversible blade.

- Grooved handle in chromed brass
- Coloured head depending on the blade diameter
- Interchangeable reversible special steel blade cut at both ends.

Delivered individually with assembled blade.



MSA		Ø	Kg
01.222-050		0.50 mm	0.001
01.222-060		0.60 mm	0.001
01.222-070		0.70 mm	0.001
01.222-080		0.80 mm	0.001
01.222-100		1.00 mm	0.001
01.222-120		1.20 mm	0.001
01.222-130		1.30 mm	0.001
01.222-150		1.50 mm	0.001

Interchangeable reversible special steel blade cut at both ends for screwdrivers with reversible blade MSA01.221-xxx.



MSA	Ø blades	Kg
01.005	0.60 - 0.80 - 1.00 - 1.20 mm	0.046

Assortment of 4 screwdrivers with reversible blade MSA01.221-xxx.

Delivered in 1 plastic pouch.

ASSORTMENT



ASSORTMENT

MSA	Ø blades	Kg
01.225	0.60 - 0.80 - 1.00 - 1.20 - 1.50 mm	0.060

Assortment of 5 screwdrivers with reversible blade MSA01.221-xxx.
Delivered in 1 plastic pouch.

Special screwdriver for glasses.



MSA	Ø blades	Kg
01.401	1.60 - 1.80 - 2.00 - 2.50 mm	0.047

Special screwdriver for glasses.
- Large knurled hollow aluminium handle
- Threaded ferrule in chromed brass for a quick changing of the interchangeable blades.
Delivered with 4 hardened-blue steel blades of different diameters, body Ø 2.50 mm.

Spare parts :

MSA	Item	Kg
01.401-160	Blade Ø 1.60 mm	0.001
01.401-180	Blade Ø 1.80 mm	0.001
01.401-200	Blade Ø 2.00 mm	0.001
01.401-250	Blade Ø 2.50 mm	0.001



MSA	Length	Kg
01.051	60 mm	0.008

Key-ring screwdriver for glasses.
- Grooved nickel-plated brass body in 2 screwed parts
- Hardened-blue steel blade Ø 1.60 mm with nickel-plated steel ring.

Device for shaping screwdriver blades.

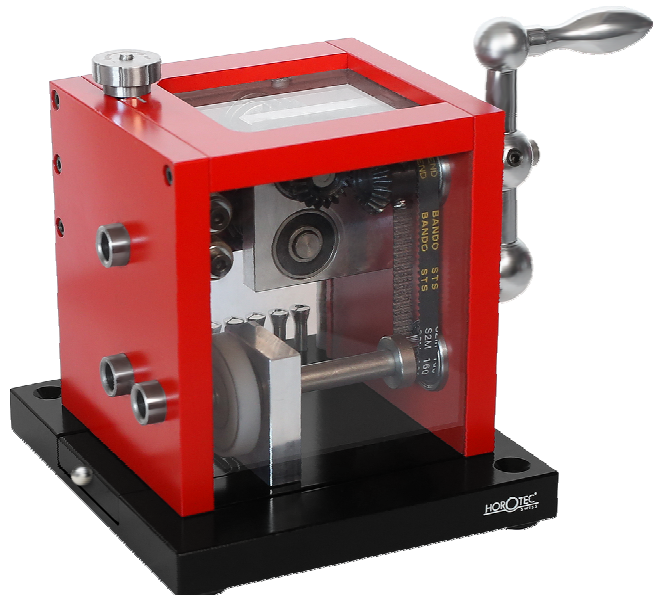

MSA	Size	Kg
01.505	180 x 130 x 135 mm	3.180

Device for forming screwdriver blades equipped with two Borazon CBN cylindrical grinding wheels grain B91 medium with adjustable spacing and one Arkansas Stone (wheel shaped).
 - This principle makes it possible to obtain a parallel blade with a controlled width
 - Handling is facilitated and it prevents damages to the screw slots
 - The watchmaker can work optimally by adapting the blade to the geometry of the screw to be processed
 - The CBN grinding wheels and the Arkansas stone are reversible and interchangeable.

Delivered with 1 tool holder, 5 tightening chucks P4.5 Ø 0.50-1.00

MSA	Item	Kg
16.042-RED	Arkansas stone wheel shaped, Ø 35 x 5 mm, hole Ø 6 mm	?
16.801	Borazon grinding-wheel grain B91 medium, head Ø 12 x 10 mm, bore Ø 6 mm	0.007

Accessories :

MSA	Item	Kg
03.875-080	Tightening chuck P 4.5 type, Ø 0.80 mm	0.002
16.800	Borazon grinding-wheel grain B126 coarse, head Ø 12 x 10 mm, bore Ø 6 mm	0.007
16.802	Borazon grinding-wheel grain B126 coarse, head Ø 12 x 10 mm, bore Ø 6 mm	0.007



MSA	Size	Kg
01.504	130 x 50 x 45 mm	0.780

Tool for shaping the screwdriver blades.
 Using this tool avoids any damage of screws slots when repairing or assembling watches. These screwdrivers with shaped blades will be mainly used for repairing of high range watches with crystal case backs showing the movements and provided with gold or blued screws.

Delivered with 3 stones (1 square and 2 round), 3 screwdriver holders and 1 user manual.

Spare parts :

MSA	Item	Kg
01.504-4.5	Screwdrivers holder, handle Ø 4.50 mm	0.058
01.504-5.0	Screwdrivers holder, handle Ø 5.00 mm	0.057
01.504-5.5	Screwdrivers holder, handle Ø 5.50 mm	0.055
01.502-V	Assortment of 5 screws	0.002
01.502-A	Interchangeable round stone	0.020
16.002	Interchangeable square stone	0.022



Tool for sharpening screwdriver blades.



MSA	Size	Kg
01.500	Ø 14 x 40 mm	0.024

Tool for sharpening screwdriver blades.
 To use preferably with 1 Arkansas stone having a minimum width of 40 mm (see chapter 16).
 No screwdriver or stones included.



Sharpening stones, see chapter 16.

NOTES

Lined area for notes, consisting of 20 horizontal lines.

02



PIN VICES

02 - 2

CUTTING BROACHES

02 - 9

ASSORTMENT OF CUTTING BROACHES

02 - 11

SMOOTHING BROACHES

02 - 12

PIN VICES

Pin vices are used to firmly hold items such as winding stems, cutting and smoothing broaches, drills, taps, wires, screws, etc.

Choosing a square or hexagonal head model will assure you a tighter fit.



MSA	Tightening	Length	Kg
02.001-01	0...1.50 mm	70 mm	0.022
02.001-02 *	0...1.80 mm	80 mm	0.025
02.001-03	0...2.30 mm	90 mm	0.030
02.001-04 *	0...2.80 mm	100 mm	0.040
02.001-05	0...3.00 mm	110 mm	0.050
02.001-06 *	0...3.50 mm	120 mm	0.060
02.001-07	0...4.00 mm	130 mm	0.080
02.001-08 *	0...5.00 mm	140 mm	0.094

Pin vice with fluted hollow brass handle and square head to prevent rolling on bench.

Delivered with 2 steel chucks.

* In assortments MSA02.026 and MSA02.027



ASSORTMENT

MSA	Kg
02.026	0.212

Assortment of 4 pin vices MSA02.001-02, -04, -06 and -08.

Delivered in 1 plastic pouch.



MSA	Kg
02.027	0.422

Assortment of 5 brass pin vices, 4 with square head (MSA02.001-02 /-04 /-06 /-08) and 1 with round head (MSA02.021).

Delivered in 1 wooden box.



MSA	Tightening	Length	Kg
02.015-01	0...1.50 mm	70 mm	0.022
02.015-02	0...1.80 mm	80 mm	0.022
02.015-03	0...2.30 mm	90 mm	0.030
02.015-04	0...2.80 mm	100 mm	0.040
02.015-05	0...3.00 mm	110 mm	0.040
02.015-06	0...3.50 mm	120 mm	0.040
02.015-07	0...4.00 mm	130 mm	0.080
02.015-08	0...5.00 mm	140 mm	0.094

Pin vice with fluted hollow nickel-plated handle and square head to prevent rolling on bench.

Provided with 2 steel chucks.



MSA	Tightening	Length	Kg
02.002-01	0...1.50 mm	70 mm	0.020
02.002-02	0...1.80 mm	80 mm	0.020
02.002-03	0...2.30 mm	90 mm	0.030
02.002-04	0...2.80 mm	100 mm	0.040
02.002-05	0...3.00 mm	110 mm	0.045
02.002-06	0...3.50 mm	120 mm	0.060
02.002-07	0...4.00 mm	130 mm	0.070
02.002-08	0...5.00 mm	140 mm	0.093

Pin vice with fluted hollow brass handle and round head.
Provided with 2 steel chucks.



MSA	Tightening	Length	Kg
02.003-01	0...0.80 mm	80 mm	0.012
02.003-02	0...0.80 mm	90 mm	0.015
02.003-03	0...0.80 mm	100 mm	0.015
02.003-04	0...0.80 mm	110 mm	0.015
02.003-05	0...0.80 mm	120 mm	0.017

Pin vice with fluted hollow brass, thin handle Ø 5 mm and round head.
Provided with 1 steel chuck.



MSA	Tightening	Length	Kg
02.014-02	0.00...0.80 mm	80 mm	0.013
02.014-04	0.00...1.00 mm	100 mm	0.025
02.014-06	1.40...2.50 mm	120 mm	0.025

Pin vice with fluted hollow brass handle and round head.
Delivered with 1 steel chuck.



MSA	Tightening	Length	Kg
02.021 *	0...0.70 mm	110 mm	0.015

Thin pin vice with conical and fluted brass handle and round head.
Provided with 1 steel chuck.

* In assortment MSA02.027



MSA	Tightening	Length	Kg
02.005	0...2.50 mm	100 mm	0.033

Double-ended pin vice with fluted nickel-plated handle and 2 round heads.
Provided with 2 steel 4-lip chucks.



MSA	Tightening	Length	Kg
02.012	0...2.80 mm	110 mm	0.038

Double-ended pin vice with fluted hollow nickel-plated handle and 2 knurled round heads.
Provided with 2 steel 4-lip chucks.

PIN VICES



MSA	Tightening	Length	Kg
02.016 *	0...0.70 mm	110 mm	0.015

Thin pin vice with conical fluted nickel-plated handle and round head.
Provided with 1 steel chuck.

* See assortment MSA02.025



MSA	Tightening	Length	Kg
02.020-01	0...1.50 mm	70 mm	0.020
02.020-02	0...1.80 mm	80 mm	0.020
02.020-03 *	0...2.30 mm	90 mm	0.025
02.020-04 *	0...2.80 mm	100 mm	0.030
02.020-05	0...3.00 mm	110 mm	0.045
02.020-06	0...3.50 mm	120 mm	0.050
02.020-08	0...5.00 mm	140 mm	0.096

Pin vice with fluted hollow nickel-plated handle and round head.
Provided with 2 steel chucks.

* See assortment MSA02.025



ASSORTMENT

MSA	Kg
02.025	0.088

Assortment of 3 pin vices with fluted hollow nickel-plated handles and round heads.

Contents : MSA02.016, 02.020-03 and 02.020-04.

Delivered in 1 plastic pouch.



Ø 2.35 mm

MSA	Tightening	Length	Kg
02.035	0...1.20 mm	55 mm	0.005

Pin vice with black finished adapter and round head. For manual use on a lathe or a drilling machine.

Provided with 1 steel chuck.



Ø 2.35 mm

MSA	Model	Tightening	Length	Kg
02.036	Medium	0.00...1.00 - 0.90...1.60 - 1.50...2.40 mm	80 mm	0.028
02.037	Large	0.00...1.30 - 1.10...2.30 - 1.70...3.00 mm	80 mm	0.028

Pin vice with black finished adapter and round head. For manual use on a lathe or a drilling machine.

Delivered with 3 interchangeable steel chucks.



MSA	Tightening	Length	Kg
02.099	0...0.90 mm	50 mm	0.008

Mini cutting broaches holder pin vice with fluted hollow handle made of aluminium.

Provided with 1 steel chuck.



MSA	Ø crowns	Model	Length	Kg
02.008-01	3...5 mm	Small	75 mm	0.031
02.008-02	4...6 mm	Medium	75 mm	0.031
02.008-03	5...7 mm	Large	75 mm	0.031

Winding crowns pin vice with knurled nickel-plated handle. Specially made for winding watches.



MSA	Tightening	Length	Kg
02.098	0...1.10 mm	60 mm	0.013

Mini cutting broaches holder pin vice with knurled hollow handle made of black steel and round head. Provided with 1 steel chuck.



MSA	Tightening	Length	Kg
02.004	0...2.80 mm	110 mm	0.040

Double-ended pin vice with fluted hollow nickel-plated handle and 2 hexagonal heads to prevent rolling on bench. Provided with 2 steel 4-lip chucks.



MSA	Tightening	Length	Kg
02.050	1.40...2.80 mm	107 mm	0.039

Double-ended pin vice with fluted hollow nickel-plated handle and 2 knurled round heads. Provided with 2 identical steel chucks with 4 cutters.



MSA	Length	Kg
02.007	110 mm	0.015

Forked pin vice with knurled nickel-plated handle. Provided with a sliding locker for an easy and quick tightening with one hand.

PIN VICES



MSA	Tightening	Length	Kg
02.030	0...1.50 mm	110 mm	0.031

Crown pin vice with knurled hollow nickel-plated handle.
Provided with a sliding locker for an easy and quick tightening with one hand.



MSA	Ø	Length	Kg
02.022-075	0.75 mm	120 mm	0.048
02.022-080	0.80 mm	120 mm	0.048
02.022-090	0.90 mm	120 mm	0.048
02.022-100	1.00 mm	120 mm	0.048
02.022-120	1.20 mm	120 mm	0.048
02.022-125	1.25 mm	120 mm	0.048
02.022-130	1.30 mm	120 mm	0.048
02.022-140	1.40 mm	120 mm	0.048
02.022-145	1.45 mm	120 mm	0.048
02.022-150	1.50 mm	120 mm	0.048
02.022-160	1.60 mm	120 mm	0.048
02.022-170	1.70 mm	120 mm	0.048
02.022-175	1.75 mm	120 mm	0.048
02.022-180	1.80 mm	120 mm	0.048
02.022-200	2.00 mm	120 mm	0.048
02.022-220	2.20 mm	120 mm	0.048
02.022-250	2.50 mm	120 mm	0.048
02.022-300	3.00 mm	120 mm	0.048
02.022-350	3.50 mm	120 mm	0.048

Pin vice for barrel staff with hollow nickel-plated hexagonal handle.
Provided with a sliding locker for an easy and quick tightening with one hand.



MSA	Ø	Length	Kg
02.006-020	0.20 mm	115 mm	0.017
02.006-025	0.25 mm	115 mm	0.017
02.006-030	0.30 mm	115 mm	0.017
02.006-035	0.35 mm	115 mm	0.017
02.006-040	0.40 mm	115 mm	0.017
02.006-045	0.45 mm	115 mm	0.017
02.006-050	0.50 mm	115 mm	0.017
02.006-055	0.55 mm	115 mm	0.017
02.006-060	0.60 mm	115 mm	0.017
02.006-065	0.65 mm	115 mm	0.017
02.006-070	0.70 mm	115 mm	0.017
02.006-075	0.75 mm	115 mm	0.017
02.006-080	0.80 mm	115 mm	0.017
02.006-085	0.85 mm	115 mm	0.017
02.006-090	0.90 mm	115 mm	0.017
02.006-095	0.95 mm	115 mm	0.017
02.006-100	1.00 mm	115 mm	0.017
02.006-110	1.10 mm	115 mm	0.017
02.006-120	1.20 mm	115 mm	0.017

Balance screws hardened steel pin vice, knurled nickel-plated handle.
Provided with a sliding locker for an easy and quick tightening with one hand.

Knurled broaches.



MSA	Ø	Length	Kg
02.024	8 mm	100 mm	0.047

Knurled steel broach, handle Ø 8.00 mm.

Delivered with 4 tightening chucks P 4.5 type Ø 1.00 - 1.60 - 2.35 - 3.00 mm (MSA03.875-100 - MSA03.875-160 - MSA03.875-235 - MSA03.875-300).

Spare part :

MSA	Item	Kg
02.024-B	Broach only	0.033
03.875-100	Tightening chuck P 4.5 type, Ø 1.00 mm	0.002
03.875-160	Tightening chuck P 4.5 type, Ø 1.60 mm	0.002
03.875-235	Tightening chuck P 4.5 type, Ø 2.35 mm	0.002
03.875-300	Tightening chuck P 4.5 type, Ø 3.00 mm	0.002

Other tightening chucks P 4.5 type :

MSA	Item	Kg
03.875-080	Tightening chuck P 4.5 type, Ø 0.80 mm	0.002
03.875-150	Tightening chuck P 4.5 type, Ø 1.50 mm	0.002
03.875-200	Tightening chuck P 4.5 type, Ø 2.00 mm	0.002
03.875-250	Tightening chuck P 4.5 type, Ø 2.50 mm	0.002
03.875-400	Tightening chuck P 4.5 type, Ø 4.00 mm	0.002

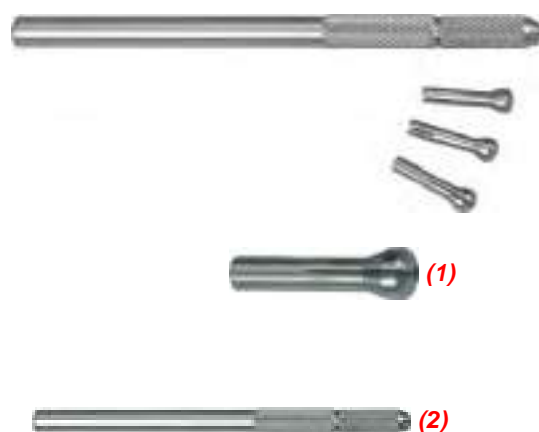

MSA	Ø	Length	Kg
02.019	6 mm	105 mm	0.026

Knurled steel broach for manual use or mounted on a lathe. Precise tightening and steady.

Delivered with 4 easily interchangeable tightening chucks Ø 0.80, 1.00, 1.20 and 1.50 mm.

Spare parts :

MSA	Item	Kg
02.019-080	(1) Tightening chuck Ø 0.80 mm	0.001
02.019-100	Tightening chuck Ø 1.00 mm	0.001
02.019-120	Tightening chuck Ø 1.20 mm	0.001
02.019-150	Tightening chuck Ø 1.50 mm	0.001
02.019-A	(2) Broach	0.020

Accessories :

MSA	Item	Kg
02.019-060	Tightening chuck Ø 0.60 mm	0.001
02.019-200	Tightening chuck Ø 2.00 mm	0.001

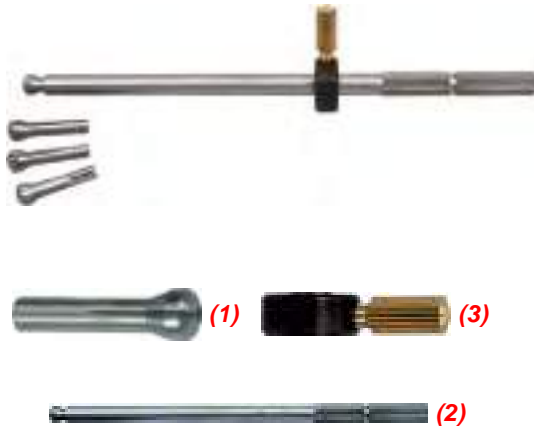

MSA	Ø	Length	Kg
02.029	4.70 mm	105 mm	0.020

Knurled steel broach for use with STAR staking tools.
 Delivered with 1 adjustment ring and 4 easily interchangeable tightening chucks Ø 0.80, 1.00, 1.20 and 1.50 mm.

Spare parts :

MSA	Item	Kg
02.019-080	(1) Tightening chuck Ø 0.80 mm	0.001
02.019-100	Tightening chuck Ø 1.00 mm	0.001
02.019-120	Tightening chuck Ø 1.20 mm	0.001
02.019-150	Tightening chuck Ø 1.50 mm	0.001
02.029-B	(2) Broach	0.015
02.029-BG	(3) Adjusting ring	0.003

Accessories :

MSA	Item	Kg
02.019-060	Tightening chuck Ø 0.60 mm	0.001
02.019-200	Tightening chuck Ø 2.00 mm	0.001

The cutting broaches are used for enlarging holes. They have a 5-sided tapered shaft (pentagonal section) with sharp cutting edges.



MSA	No.	Total length (L)	Useful length (u)	Ø (D)	Ø (d)	Kg
02.100-01	01	162 mm	107 mm	5.75 mm	4.80 mm	0.030
02.100-02	02	160 mm	105 mm	5.50 mm	4.50 mm	0.030
02.100-04	04	158 mm	104 mm	5.25 mm	4.30 mm	0.030
02.100-08	08	156 mm	103 mm	5.00 mm	4.10 mm	0.030
02.100-12	12	154 mm	102 mm	4.75 mm	3.80 mm	0.030
02.100-16	16	151 mm	100 mm	4.50 mm	3.60 mm	0.030
02.100-18	18	149 mm	99 mm	4.25 mm	3.40 mm	0.030
02.100-22	22	147 mm	98 mm	4.00 mm	3.10 mm	0.030
02.100-26	26	145 mm	97 mm	3.75 mm	2.70 mm	0.030
02.100-28	28	142 mm	96 mm	3.50 mm	2.60 mm	0.030
02.100-30	30	140 mm	95 mm	3.25 mm	2.40 mm	0.030
02.100-31	31	138 mm	93 mm	3.00 mm	2.20 mm	0.030
02.100-32	32	135 mm	91 mm	2.90 mm	2.10 mm	0.020
02.100-35	35	132 mm	89 mm	2.80 mm	2.05 mm	0.020
02.100-36	36	129 mm	87 mm	2.70 mm	2.00 mm	0.020
02.100-38	38	127 mm	85 mm	2.60 mm	1.90 mm	0.020
02.100-40	40	125 mm	82 mm	2.50 mm	1.80 mm	0.020
02.100-41	41	122 mm	80 mm	2.40 mm	1.75 mm	0.020
02.100-42	42	119 mm	78 mm	2.30 mm	1.70 mm	0.020
02.100-44	44	116 mm	76 mm	2.20 mm	1.60 mm	0.020
02.100-45	45	113 mm	74 mm	2.10 mm	1.50 mm	0.020
02.100-46	46	110 mm	72 mm	2.00 mm	1.40 mm	0.020
02.100-48	48	107 mm	70 mm	1.90 mm	1.30 mm	0.020
02.100-49	49	104 mm	68 mm	1.80 mm	1.20 mm	0.010
02.100-51	51	101 mm	65 mm	1.70 mm	1.15 mm	0.010
02.100-52	52	98 mm	63 mm	1.60 mm	1.10 mm	0.010
02.100-53	53	95 mm	61 mm	1.50 mm	1.00 mm	0.010
02.100-54	54	92 mm	59 mm	1.40 mm	0.90 mm	0.010
02.100-55	55	89 mm	57 mm	1.30 mm	0.80 mm	0.010
02.100-56	56	86 mm	54 mm	1.20 mm	0.70 mm	0.010
02.100-58	58	83 mm	52 mm	1.10 mm	0.63 mm	0.010
02.100-60	60	80 mm	50 mm	1.00 mm	0.57 mm	0.010
02.100-62	62	77.5 mm	48 mm	0.95 mm	0.54 mm	0.010
02.100-64	64	75 mm	47 mm	0.90 mm	0.50 mm	0.010
02.100-65	65	72.5 mm	46 mm	0.85 mm	0.48 mm	0.010
02.100-66	66	70.5 mm	44 mm	0.80 mm	0.45 mm	0.001
02.100-68	68	68 mm	42 mm	0.75 mm	0.41 mm	0.001
02.100-70	70	66 mm	41 mm	0.70 mm	0.37 mm	0.001
02.100-71	71	64 mm	40 mm	0.65 mm	0.34 mm	0.001
02.100-72	72	62 mm	38 mm	0.60 mm	0.30 mm	0.001
02.100-74	74	60 mm	37 mm	0.55 mm	0.28 mm	0.001
02.100-75	75	58 mm	36 mm	0.50 mm	0.25 mm	0.001
02.100-76	76	56 mm	34 mm	0.45 mm	0.20 mm	0.001
02.100-78	78	54 mm	33 mm	0.40 mm	0.15 mm	0.001
02.100-79	79	52 mm	32 mm	0.35 mm	0.13 mm	0.001
02.100-80	80	50 mm	31 mm	0.30 mm	0.10 mm	0.001

5-sided conical cutting broach, without handle, made of tool steel. The taper is 1:100. The numbers correspond to the measurements from the English screw-plate (Stubs) and in mm. Size (D) is measured slightly below largest portion of cutting edges.

CUTTING BROACHES



MSA	No.	Useful length (u)	Ø (D)	Ø (d)	Kg
02.170-01	01	107 mm	5.75 mm	4.80 mm	0.035
02.170-02	02	105 mm	5.50 mm	4.50 mm	0.025
02.170-04	04	104 mm	5.25 mm	4.30 mm	0.020
02.170-08	08	103 mm	5.00 mm	4.10 mm	0.020
02.170-12	12	102 mm	4.75 mm	3.80 mm	0.020
02.170-16	16	100 mm	4.50 mm	3.60 mm	0.015
02.170-18	18	99 mm	4.25 mm	3.40 mm	0.015
02.170-22	22	98 mm	4.00 mm	3.10 mm	0.010
02.170-26	26	97 mm	3.75 mm	2.70 mm	0.010
02.170-28	28	96 mm	3.50 mm	2.60 mm	0.010
02.170-30	30	95 mm	3.25 mm	2.40 mm	0.010
02.170-31	31	93 mm	3.00 mm	2.20 mm	0.005
02.170-32	32	91 mm	2.90 mm	2.10 mm	0.005
02.170-35	35	89 mm	2.80 mm	2.05 mm	0.005
02.170-36	36	87 mm	2.70 mm	2.00 mm	0.004
02.170-38	38	85 mm	2.60 mm	1.90 mm	0.004
02.170-40	40	82 mm	2.50 mm	1.80 mm	0.004
02.170-41	41	80 mm	2.40 mm	1.75 mm	0.003
02.170-42	42	78 mm	2.30 mm	1.70 mm	0.003
02.170-44	44	76 mm	2.20 mm	1.60 mm	0.003
02.170-45	45	74 mm	2.10 mm	1.50 mm	0.002
02.170-46	46	72 mm	2.00 mm	1.40 mm	0.002
02.170-48	48	70 mm	1.90 mm	1.30 mm	0.002
02.170-49	49	68 mm	1.80 mm	1.20 mm	0.001
02.170-51	51	65 mm	1.70 mm	1.15 mm	0.001
02.170-52	52	63 mm	1.60 mm	1.10 mm	0.001
02.170-53	53	61 mm	1.50 mm	1.00 mm	0.001
02.170-54	54	59 mm	1.40 mm	0.90 mm	0.001
02.170-55	55	57 mm	1.30 mm	0.80 mm	0.001
02.170-56	56	54 mm	1.20 mm	0.70 mm	0.001
02.170-58	58	52 mm	1.10 mm	0.63 mm	0.001
02.170-60	60	50 mm	1.00 mm	0.57 mm	0.001
02.170-64	64	47 mm	0.90 mm	0.50 mm	0.001
02.170-66	55	44 mm	0.80 mm	0.45 mm	0.001
02.170-70	70	41 mm	0.70 mm	0.37 mm	0.001
02.170-72	72	38 mm	0.60 mm	0.30 mm	0.001
02.170-75	75	36 mm	0.50 mm	0.25 mm	0.001
02.170-78	78	33 mm	0.40 mm	0.15 mm	0.001
02.170-80	80	31 mm	0.30 mm	0.10 mm	0.001
02.170-020	020	20 mm	0.20 mm	0.07 mm	0.001
02.170-015	015	18 mm	0.15 mm	0.05 mm	0.001
02.170-010	010	17 mm	0.10 mm	0.0 mm	0.001
02.170-008	008	16 mm	0.08 mm	0.03 mm	0.001
02.170-005	005	15 mm	0.05 mm	0.02 mm	0.001

5-sided conical cutting broach, with plastic handle, made of tool steel. The taper is 1:100. The numbers correspond to the measurements from the English screw-plate (Stubs) and in mm. Size (D) is measured slightly below largest portion of cutting edges.



MSA	Packaging size	Kg
02.155	60 x 44 mm	0.010

Assortment of 12 extra thin cutting broaches with plastic handle.
Contents : Ø 0.05, 0.08, 0.10, 0.15, 0.20, 0.25, 0.30, 0.35, 0.40, 0.45, 0.50 and 0.55 mm.



MSA	Packaging size	Kg
02.151	133 x 60 mm	0.010

Assortment of 6 5-sided cutting broaches with plastic handle.
Contents : Ø 0.40, 0.60, 0.80, 1.00, 1.20 and 1.40 mm.



MSA	Packaging size	Kg
02.150	133 x 60 mm	0.013

Assortment of 6 5-sided cutting broaches with plastic handle.
Contents : Ø 0.60, 0.80, 1.00, 1.30, 1.60 and 2.00 mm.



MSA	Packaging size	Kg
02.152	152 x 15 x 15 mm	0.029

Assortment of 6 5-sided cutting broaches with plastic handle.
Contents : Ø 0.70, 1.00, 1.50, 2.00, 2.50 and 3.00 mm.



MSA	Packaging size	Kg
02.153	152 x 15 x 15 mm	0.030

Assortment of 6 5-sided cutting broaches with plastic handle.
Contents : Ø 1.20, 1.50, 1.80, 2.20, 2.50 and 3.00 mm.



MSA	Packaging size	Kg
02.161	205 x 65 mm	0.112

Assortment of 6 5-sided cutting broaches with plastic handle. Large models for watches, alarm clocks and clocks.
Contents : Ø 1.50, 2.20, 3.00, 4.00, 5.50 and 7.00 mm.



MSA	Packaging size	Kg
02.160	205 x 65 mm	0.110

Assortment of 6 5-sided cutting broaches with plastic handle. Large models for alarm clocks and clocks.
Contents : Ø 2.20, 2.50, 3.00, 4.00, 5.00 and 6.00 mm.



MSA	Packaging size	Kg
02.162	250 x 75 mm	0.330

Assortment of 4 5-sided cutting broaches with plastic handle. Large models for alarm clocks and clocks.
Contents : Ø 7.00, 8.00, 9.25 and 10.50 mm.

SMOOTHING BROACHES

Smoothing broaches are used for polishing the holes.



MSA	No.	Useful length (u)	Ø (D)	Ø (d)	Kg
02.250-01	01	107 mm	5.75 mm	4.80 mm	0.035
02.250-02	02	105 mm	5.50 mm	4.50 mm	0.035
02.250-04	04	104 mm	5.25 mm	4.30 mm	0.035
02.250-08	08	103 mm	5.00 mm	4.10 mm	0.035
02.250-12	12	102 mm	4.75 mm	3.80 mm	0.035
02.250-16	16	100 mm	4.50 mm	3.60 mm	0.030
02.250-18	18	99 mm	4.25 mm	3.40 mm	0.030
02.250-22	22	98 mm	4.00 mm	3.10 mm	0.030
02.250-26	26	97 mm	3.75 mm	2.70 mm	0.030
02.250-28	28	96 mm	3.50 mm	2.60 mm	0.030
02.250-30	30	95 mm	3.25 mm	2.40 mm	0.025
02.250-31	31	93 mm	3.00 mm	2.20 mm	0.025
02.250-32	32	91 mm	2.90 mm	2.10 mm	0.025
02.250-35	35	89 mm	2.80 mm	2.05 mm	0.025
02.250-36	36	87 mm	2.70 mm	2.00 mm	0.025
02.250-38	38	85 mm	2.60 mm	1.90 mm	0.020
02.250-40	40	82 mm	2.50 mm	1.80 mm	0.020
02.250-41	41	80 mm	2.40 mm	1.75 mm	0.020
02.250-42	42	78 mm	2.30 mm	1.70 mm	0.020
02.250-44	44	76 mm	2.20 mm	1.60 mm	0.020
02.250-45	45	74 mm	2.10 mm	1.50 mm	0.015
02.250-46	46	72 mm	2.00 mm	1.40 mm	0.015
02.250-48	48	70 mm	1.90 mm	1.30 mm	0.015
02.250-49	49	68 mm	1.80 mm	1.20 mm	0.015
02.250-51	51	65 mm	1.70 mm	1.15 mm	0.015
02.250-52	52	63 mm	1.60 mm	1.10 mm	0.010
02.250-53	53	61 mm	1.50 mm	1.00 mm	0.010
02.250-54	54	59 mm	1.40 mm	0.90 mm	0.010
02.250-55	55	57 mm	1.30 mm	0.80 mm	0.010
02.250-56	56	54 mm	1.20 mm	0.70 mm	0.010
02.250-58	58	52 mm	1.10 mm	0.63 mm	0.001
02.250-60	60	50 mm	1.00 mm	0.57 mm	0.001
02.250-64	64	47 mm	0.90 mm	0.50 mm	0.001
02.250-66	66	44 mm	0.80 mm	0.45 mm	0.001
02.250-70	70	41 mm	0.70 mm	0.37 mm	0.001
02.250-72	72	38 mm	0.60 mm	0.30 mm	0.001
02.250-75	75	36 mm	0.50 mm	0.25 mm	0.001
02.250-78	78	33 mm	0.40 mm	0.15 mm	0.001
02.250-80	80	31 mm	0.30 mm	0.10 mm	0.001

Smoothing broach, with plastic handle, made of tool steel. The taper is 1:100. The numbers correspond to the measurements from the English screw-plate (Stubs) and in mm. Size (D) is measured slightly below largest portion of cutting edges.



ASSORTMENT

MSA	Packaging size	Kg
02.221	133 x 60 mm	0.010

Assortment of 6 smoothing broaches with plastic handle.
 Contents : Ø 0.40, 0.60, 0.80, 1.00, 1.20 and 1.40 mm.



ASSORTMENT

MSA	Packaging size	Kg
02.220	133 x 60 mm	0.013

Assortment of 6 smoothing broaches with plastic handle.
 Contents : Ø 0.60, 0.80, 1.00, 1.30, 1.60 and 2.00 mm.

Assortments of smoothing broaches in wooden box.



MSA22.567

See chapter 22.



MSA22.571

See chapter 22.

03



SPECIALIZED WATCH MAKING TOOLS

03 - 2

LATHES

03 - 11

RIVETING STAKES

03 - 15

DRILL MACHINES

03 - 16

**Tools for locking/unlocking oscillating weight bolts.
Calibres 2892... and 7750...**



MSA	For calibres	Kg
03.676-2892	ETA 2892 - 2893 - 2894 - 2895	0.665
03.676-7750	ETA 7750 - 7751 - 7753	0.665

Press for locking/unlocking oscillation weight bolts. The broach is mounted on spring for a fast and precise job. The broach is interchangeable and easily disassembled by unscrewing the head.
Delivered without movement holder MSA03.678-xxx or MSA03.680-xxx.

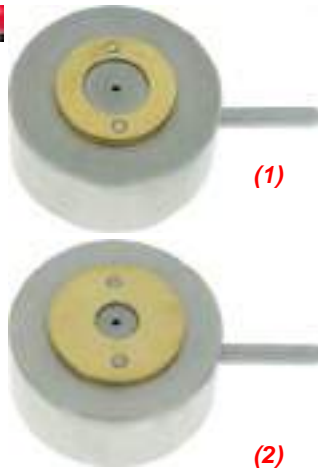

MSA	For calibres	Kg
03.680-2892 (1)	ETA 2892 - 2893 - 2894 - 2895 - 2896 - 2897	0.078
03.680-7750 (2)	ETA 7700 - 7750 - A07111 - A07161 - A07271	0.079

Support for assembling/disassembling the oscillating weight bolts.

Spare part :

MSA	Item	Kg
03.676-A	Guide staff Ø 4 mm	0.001



MSA	For calibres	Kg
03.678-2892 (1)	ETA 2892 - 2893 - 2894 - 2895	0.070
03.678-7750 (2)	ETA 7750 - 7751 - 7753	0.090

Base holder for MSA03.676-2892 and 03.676-7750.



MSA	For calibres	Kg
03.679-2892	ETA 2892 - 2893 - 2894 - 2895	0.090
03.679-7750	ETA 7750 - 7751 - 7753	0.110

Broach for MSA03.676-xxxx and 03.677-xxxx.

Tools for assembling/disassembling oscillating weight bolts, screw-on pushers, screw-on tubes and battery covers.



MSA	Kg
03.675	0.170

Tool for locking/unlocking oscillating weight bolts.
 Delivered with 2 interchangeable snap-on keys (MSA03.620-2892 and 03.620-7750) and a detailed user's manual.

Spare parts :

MSA	Item	Kg
03.620-2892	Key for calibres 2892, 2893, 2894 and 2895	0.008
03.620-7750	Key for calibres 2000-1, 7750, 7751 and 7753	0.008
03.620-A	Hexagonal handle compatible with all illustrated keys	0.060



MSA	Size	Kg
03.622	120 x 70 x 35 mm	0.448

Tool for assembling/disassembling screw-on pushers and tubes.

Contents :
 - 1 plate
 - 1 hexagonal handle MSA03.620-A
 - 13 interchangeable keys MSA03.620-01, -02, -03, -04, -05, -06, -07, -08, -203, -207, -P3, -P27 and -P39.
 See next page for details of spare parts.



MSA	Size	Kg
03.623	120 x 70 x 35 mm	0.460

Tool for locking/unlocking oscillating weight bolts and assembling/disassembling screw-on pushers and tubes.

Contents :
 - 1 plate
 - 1 hexagonal handle MSA03.620-A
 - 15 interchangeable keys MSA03.620-01, -02, -03, -04, -05, -06, -07, -08, -203, -207, -2892, -7750, -P3, -P27 and -P39.
 See next page for details of spare parts.











MSA	Size	Kg
03.621	120 x 70 x 35 mm	0.496

Tool for locking/unlocking oscillating weight bolts and assembling/disassembling screw-on pushers, screw-on tubes and battery covers.





Contents :
 - 1 plate
 - 1 hexagonal handle MSA03.620-A
 - 18 interchangeable keys MSA03.620-01, -02, -03, -04, -05, -06, -07, -08, -203, -207, -2892, -7750, -GENT, -LADY, -MED, -P3, -P27 and -P39.
 See below the details of spare parts.

SPECIALIZED WATCH MAKING TOOLS

Spare parts for screwing tubes :

MSA	Item	Kg	
03.620-01	Key for tubes MSA65.001, Ø 1.50 mm	0.005	
03.620-02	Key for tubes MSA65.002, Ø 1.80 mm	0.005	
03.620-03	Key for tubes MSA65.003, Ø 2.65 mm	0.005	
03.620-04	Key for tubes MSA65.004, Ø 2.75 mm	0.005	
03.620-05	Key for tubes MSA65.005, Ø 2.95 mm	0.005	
03.620-06	Key for tubes MSA65.006, Ø 3.00 mm	0.005	
03.620-07	Key for tubes MSA65.007, Ø 3.00 mm	0.005	
03.620-08	Key for tubes OM SEAM.	0.005	

Spare parts for screwing pushers :

MSA	Item	Kg	
03.620-203	Key for pushers MSA61.203 / .703	0.005	
03.620-207	Key for pushers MSA61.207 / .707	0.005	
03.620-P27	Key for pushers type P27	0.006	
03.620-P3	Key for pushers type P3	0.006	
03.620-P39	Key for pushers type P39	0.006	

Spare parts for oscillating weight bolts :

MSA	Item	Kg	
03.620-2892	Key for calibres 2892, 2893, 2894 and 2895	0.008	
03.620-7750	Key for calibres 2000-1, 7750, 7751 and 7753	0.008	

Spare parts for Swatch® battery covers :

MSA	Item	Kg	
03.620-GENT	Key for Gent watches	0.015	
03.620-LADY	Key for Lady watches	0.015	
03.620-MED	Key for Medium watches	0.015	

Spare part :

MSA	Item	Kg	
03.620-A	Hexagonal handle compatible with all illustrated keys	0.060	



MSA	Type	Internal Ø	Kg
03.653-P3	P3	3.00 mm	0.060
03.653-P27	P27	3.50 mm	0.060
03.653-P39	P39	3.60 mm	0.060

Tool for screw/unscrew fluted pusher tubes.
Aluminium handle.

Tools for riveting oscillating weight axles.



ASSORTMENT

MSA	Kg
03.666	0.110

Assortment of 4 punchers for riveting oscillating weight axles.

Spare parts :

MSA	Item	Kg
03.666-1570	Puncher, Ø 4.70 x L85 mm	0.011
03.666-2135	Puncher, Ø 4.70 x L85 mm	0.011
03.666-2235	Puncher, Ø 4.70 x L85 mm	0.011
03.666-3035	Puncher, Ø 4.70 x L85 mm	0.011

Press for fitting/removing press-in pushers and crown tubes.

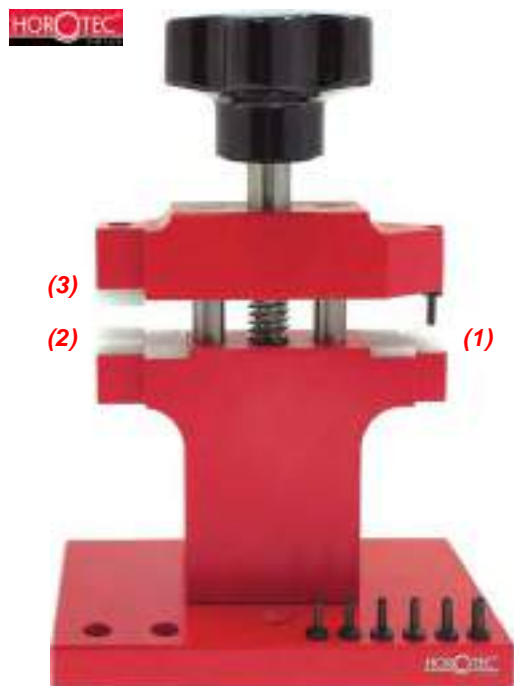

MSA	Size	Kg
03.657	100 x 60 x 142 mm	0.480

Press for fitting/removing press-in pushers and crown tubes easily and without damage.

Delivered with 7 stakes, external Ø from 1.55 to 2.95 mm.

Spare parts :

MSA	Item	Kg
03.654-A	(1) Stake Ø ext. 2.95 - Ø int. 1.55 mm	0.001
03.654-B	Stake Ø ext. 2.65 - Ø int. 1.55 mm	0.001
03.654-C	Stake Ø ext. 2.45 - Ø int. 1.55 mm	0.001
03.654-D	Stake Ø ext. 2.15 - Ø int. 1.55 mm	0.001
03.654-E	Stake Ø ext. 1.95 - Ø int. 1.55 mm	0.001
03.654-F	Stake Ø ext. 1.75 - Ø int. 1.55 mm	0.001
03.654-G	Stake Ø ext. 1.55 - Ø int. 1.55 mm	0.001
03.654-H	(2) Removing support	0.001
03.656-A	(3) Lower fitting support	0.001
03.656-B	(4) Upper fitting support	0.001



Keys for screw/unscrew pushers.



MSA	Internal Ø	Kg
03.655	3.10 mm	0.007

Steel key for screw/unscrew the chronograph pushers MSA61.207 and 61.707.

Nice black finish.

Keys for screw/unscrew the tubes of screw-on crowns.



MSA	For tubes	External Ø	Kg
03.665-01	MSA65.001	1.60 mm	0.006
03.665-02	MSA65.002	1.90 mm	0.006
03.665-03	MSA65.003	2.65 mm	0.006
03.665-04	MSA65.004	2.70 mm	0.006
03.665-05	MSA65.005	2.90 mm	0.006
03.665-06	MSA65.006	3.05 mm	0.006

Steel key for screw/unscrew the tubes of screw-on crowns to assure waterproof of diving watches.

Nice black finish.

Crowns extractor.



MSA	Size	Kg
03.604	40 x 15 x 25 mm	0.023

Crowns extractor with adjustment screw.

Tools for lanterning canon pinions.



MSA	Size	Kg
03.005	50 x 50 x 120 mm	0.317

Press for lanterning canon pinions with hard metal beaks and sliding ring mounted on grooved broach.

This press can be used in 2 different ways :

- (1) - With the standard broach for single use.
- (2) - With the grooved scale broach and 1 screwed sliding ring for height punch adjustment.

Spare parts :

MSA	Item	Kg
03.005-A	Punch stem with weight	0.050
03.005-B	Broach with beak, L54 x Ø 4 mm + Lower beak, L16 x Ø 4 mm	0.008

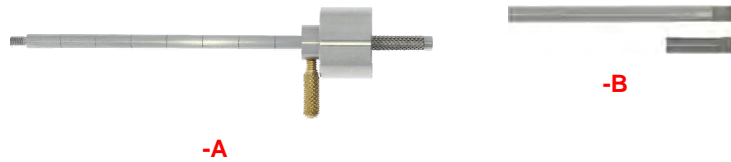

MSA	Size	Kg
03.004	97 x 7 x 45 mm	0.135

Tool for lanterning canon pinions, fixable on a vice.

Setting rounds.



MSA	Ø	Ø hole	Kg
03.428	35 mm	4.50 mm	?
03.429	35 mm	3.50 mm	?

Setting round with glass top and grey anodized aluminium body.

Tools for hairspring collets.



MSA	Ø	Kg	MSA	Ø	Kg
03.101-03	0.30 mm	0.006	03.101-08	0.80 mm	0.006
03.101-04	0.40 mm	0.006	03.101-09	0.90 mm	0.006
03.101-05	0.50 mm	0.006	03.101-10	1.00 mm	0.006
03.101-06	0.60 mm	0.006	03.101-12	1.20 mm	0.006
03.101-07	0.70 mm	0.006			

Broaches for hairspring collets with nickel-plated brass knurled handle.
Length 98 mm.



MSA	External Ø	Ø hole	Length	Kg
03.102-11	1.10 mm	0.45 mm	95 mm	0.010
03.102-16	1.60 mm	0.55 mm	95 mm	0.010
03.102-21	2.10 mm	0.75 mm	95 mm	0.010

Tool for turning and setting hairspring collets with nickel-plated brass knurled handle.



MSA	Spatulas width	Total length	Kg
03.103-E	1.80 mm	95 mm	0.015
03.103-C	2.50 mm	115 mm	0.022
03.103-D	3.00 mm	120 mm	0.024

PAIR

Pair of hairspring collets levers with nickel-plated brass knurled handle.

Truing callipers.



MSA	Size	Kg
03.416	?	?

Truing calliper for the control of wheels or balances. A stop screw enables the fine adjustment of its opening.
Equipped with 4 safety-runners, 2 conical and 2 in ruby with holes Ø 0.15 mm.

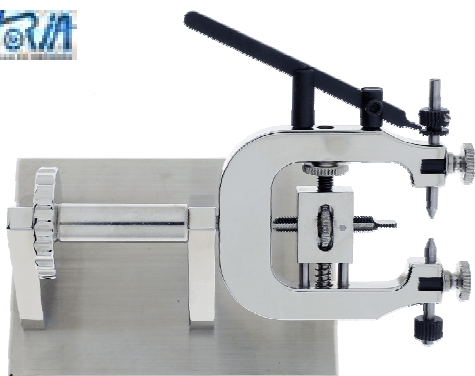

MSA	Size	Kg
03.415	85 x 70 mm	0.260

Truing calliper on base.

Poising tool.



MSA	Size	Kg
03.419	80 x 50 x 45 mm	0.300

Poising tool with spirit level Ø 18 mm and 2 adjustable feet.
Delivered with 2 ruby jaws MSA03.419-A, length 15 mm.

Spare parts :

MSA	Item	Kg
03.419-A	Ruby jaw	0.001
03.419-B	Wooden box	0.175



Tools for stud holding and for setting balance screws.



MSA	Size	Kg
03.200	Ø 40 x 9 mm	0.106

Tool for stud holding, used for fixing the stud on the balance-spring.



MSA	Size	Kg
03.424	Ø 40 x 7 mm	0.030

Nickel-plated brass tool with holes for setting the balances, with 12 holes from Ø 0.5 to 2.5 mm.

Tools for winding stems.

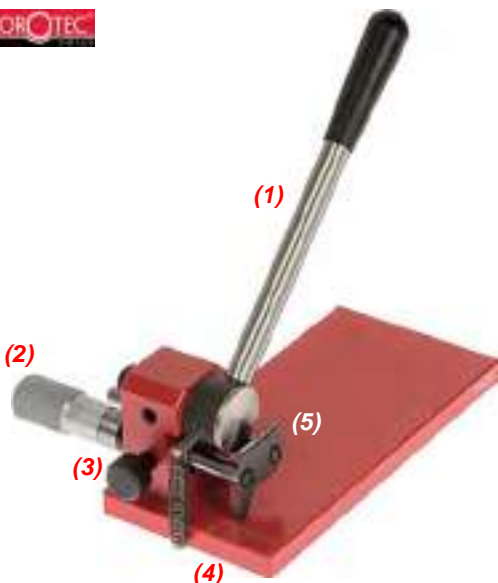

MSA	Base size	Kg
03.602	60 x 118 mm	0.353

Tool for shortening winding stems, allowing the length setting of stems in serial production.

Description :

- (1) - Lever with ergonomic handle with 1 return spring
- (2) - Micrometric screw graduated to 1/10 mm for precise setting of cut length
- (3) - Blocking screw to always keep the same length during cutting in serial production
- (4) - Base equipped with a small ruler with divisions from 0 to 15 mm
- (5) - Side pierced with 3 holes suitable for stems Ø 0.90, 1.00 and 1.20 mm.

Spare parts :

MSA	Item	Kg
03.602-A	Spring	0.001
03.602-B	Knife	0.016





MSA	∅	Kg	MSA	∅	Kg
03.600-08	0.80 mm	0.030	03.600-13	1.30 mm	0.030
03.600-09	0.90 mm	0.030	03.600-14	1.40 mm	0.030
03.600-10	1.00 mm	0.030	03.600-15	1.50 mm	0.030
03.600-11	1.10 mm	0.030	03.600-16	1.60 mm	0.030
03.600-12	1.20 mm	0.030			

Tool for shortening winding stems, with knurled handle. Provided with a stop for regular cutting.
Length 70 mm.



MSA	Kg
03.603	0.100

Tool for oiling the winding stems. Allows a perfect, clean and quick greasing for all types of stems.

Spare part :

MSA	Item	Kg
03.603-A	Cup with felt	0.007



Other tools.



MSA	Size	Kg
03.006	127 x 80 mm	1.050

Tool used to check the perfect straightness of stems. This tool is usually placed in a vice.
Delivered without American chuck. See MSA03.839-x (page 03-16).



MSA	Length	Kg
03.010	115 mm	0.011

Lantern-chuck. Tool to hold the screw by its head used to shorten or round and polish the screw thread end.
Delivered with 3 heads of different diameters.

Spare parts :

MSA	Item	Kg
03.010-040	Head for ∅ 0.40 mm	0.001
03.010-060	Head for ∅ 0.60 mm	0.001
03.010-080	Head for ∅ 0.80 mm	0.001



MSA	Size	Kg
03.310	∅ 25 x 19 mm	0.022

Tool for closing barrel covers.

SPECIALIZED WATCH MAKING TOOLS



MSA	Size	Kg
03.019	140 x 70 x 35 mm	0.115

The specialised watchmaking tool kit is the essential ally of watchmaking professionals for precise interventions.

This ingenious box contains four specialised tools :

- MSA03.011 : tool for shockproof spring Novodiac
- MSA03.012 : tool for shockproof spring Novodiac
- MSA03.014 : tool for turning the stud and the regulator pins block ETACHRON
- MSA03.015 : tool for pressing out the stud from the stud support ETACHRON.



MSA	Kg
03.011	0.013

Tool for shockproof spring Novodiac.
For calibres ETA 2801 - 2824-2 - 2834-2 - 2836-2 - 6497.



MSA	Kg
03.012	0.013

Tool for shockproof spring Novodiac.
For calibres ETA 2660 - 2671 - 2688.



MSA	Kg
03.015	0.008

Tool for pressing out the stud from the stud support ETACHRON.



MSA	Kg
03.014	0.008

Tool for turning the stud and the regulator pins block ETACHRON.



MSA	Kg
03.016	0.008

Tool for opening the dial bolts (fastener split pin).
Mirror polished tip.

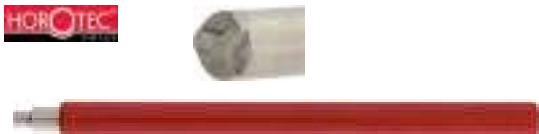

MSA	Kg
03.017	0.008

Tool for oscillating weight bolts.



MSA	Size	Kg
03.018	Ø 6 x 61.50 mm	0.017

Corrector tool with black POM tip.

Spare part :

MSA	Item	Kg
03.018-A	Black POM tip	0.002

Special lathes for polishing pivots.



(1)

MSA	Type	Version
03.452	(1)	106 With 3 broaches MSA 03.467, MSA03.474 and MSA03.475
03.454	108	With 4 broaches MSA03.467, MSA03.468, MSA03.469 and MSA03.475

Nickel-plated brass pivoting tool with 3 broaches (24 notches and 48 lanterns) or 4 broaches (36 notches and 72 lanterns).
Delivered in a wooden box.

Spare broaches for MSA03.452 and MSA03.454 :

MSA	Item
03.467	Type 123 : Broach with conical notched disk. For seconds \varnothing 0.15 - 0.30 mm
03.468	Broach with lantern and notched disk. For pivots \varnothing 0.04 - 0.10 mm
03.469	Type 125 : Broach with lantern and notched disk. For pivots \varnothing 0.10 - 0.15 mm
03.474	Type 126 : Broach with lantern and notched disk. For pivots \varnothing 0.04 - 0.15 mm
03.475	Type 127 : Broach with lantern and notched disk. For pivots \varnothing 0.16 - 0.36 mm

Spare parts for MSA03.452 and MSA03.454 :

MSA	Item
03.425-A	Type 131 : Pivot gauge \varnothing 0.05 - 0.40 mm
03.425-B	Type 131a : Pivot gauge \varnothing 0.40 - 0.80 mm
03.425-C	Type 131b : Pivot gauge \varnothing 0.80 - 1.20 mm
03.470	Type 119 : Supplement for sliding puppet
03.472	Type 135 : Pulley with fork
03.473	Type 135a : Fork
03.476	Type 118a : Broach with notched disks for pivots \varnothing 0.38 - 0.76 mm
03.477	Type 117a : Broach with notched disks for pivots \varnothing 0.38 - 1.00 mm
03.478	Type 118 : Broach with notched disks for pivots \varnothing 0.38 - 1.20 mm
03.479	Type 122 : Cylinder for broaches MSA03.468, 03.469 and 03.474
03.481	Type 155a : Bow for hand work
03.484	Type 155 : Bow for hand work, spring steel

???



MSA

03.483

Lathe for polishing screws.

Contents :

- 1 wooden box
- 1 lathe with chuck and broach : body 8 mm, \varnothing 5 mm
- 4 grinding wheels \varnothing 50 mm : 1 cast iron, 1 bronze, 1 boxwood and 1 tin
- 1 set of 22 chucks : body 5 mm from \varnothing 0.40 to 2.50 mm
- 1 set of 12 lanterns : body 5 mm from \varnothing 0.30 to 2.50 mm.

American chucks.



MSA	Ø	Kg	MSA	Ø	Kg
03.840-0.3	0.30 mm	0.090	03.840-2.0	2.00 mm	0.090
03.840-0.4	0.40 mm	0.090	03.840-2.2	2.20 mm	0.090
03.840-0.5	0.50 mm	0.090	03.840-2.3	2.30 mm	0.090
03.840-0.6	0.60 mm	0.090	03.840-2.4	2.40 mm	0.090
03.840-0.7	0.70 mm	0.090	03.840-2.5	2.50 mm	0.090
03.840-0.8	0.80 mm	0.090	03.840-2.6	2.60 mm	0.090
03.840-0.9	0.90 mm	0.090	03.840-2.7	2.70 mm	0.090
03.840-1.0	1.00 mm	0.090	03.840-2.8	2.80 mm	0.090
03.840-1.1	1.10 mm	0.090	03.840-2.9	2.90 mm	0.090
03.840-1.2	1.20 mm	0.090	03.840-3.0	3.00 mm	0.090
03.840-1.3	1.30 mm	0.090	03.840-3.5	3.50 mm	0.090
03.840-1.4	1.40 mm	0.090	03.840-4.0	4.00 mm	0.090
03.840-1.5	1.50 mm	0.090	03.840-4.5	4.50 mm	0.090
03.840-1.6	1.60 mm	0.090	03.840-4.6	4.60 mm	0.090
03.840-1.7	1.70 mm	0.090	03.840-5.0	5.00 mm	0.090
03.840-1.8	1.80 mm	0.090	03.840-6.0	6.00 mm	0.090
03.840-1.9	1.90 mm	0.090	03.840-7.0	7.00 mm	0.090

B8 american chuck.



MSA	Ø	Kg	MSA	Ø	Kg
03.839-030	0.30 mm	0.060	03.839-200	2.00 mm	0.060
03.839-050	0.50 mm	0.060	03.839-210	2.10 mm	0.060
03.839-060	0.60 mm	0.060	03.839-220	2.20 mm	0.060
03.839-070	0.70 mm	0.060	03.839-230	2.30 mm	0.060
03.839-080	0.80 mm	0.060	03.839-240	2.40 mm	0.060
03.839-090	0.90 mm	0.060	03.839-250	2.50 mm	0.060
03.839-100	1.00 mm	0.060	03.839-260	2.60 mm	0.060
03.839-110	1.10 mm	0.060	03.839-270	2.70 mm	0.060
03.839-120	1.20 mm	0.060	03.839-280	2.80 mm	0.060
03.839-130	1.30 mm	0.060	03.839-290	2.90 mm	0.060
03.839-140	1.40 mm	0.060	03.839-300	3.00 mm	0.060
03.839-150	1.50 mm	0.060	03.839-350	3.50 mm	0.060
03.839-160	1.60 mm	0.060	03.839-400	4.00 mm	0.060
03.839-170	1.70 mm	0.060	03.839-450	4.50 mm	0.060
03.839-180	1.80 mm	0.060	03.839-500	5.00 mm	0.060
03.839-190	1.90 mm	0.060			

American chuck B6/128.

Chucks P 4.5 type.



Tightening chuck 4.5 type.

MSA	Item	Kg
03.875-080	Tightening chuck P 4.5 type, Ø 0.80 mm	0.002
03.875-100	Tightening chuck P 4.5 type, Ø 1.00 mm	0.002
03.875-150	Tightening chuck P 4.5 type, Ø 1.50 mm	0.002
03.875-160	Tightening chuck P 4.5 type, Ø 1.60 mm	0.002
03.875-200	Tightening chuck P 4.5 type, Ø 2.00 mm	0.002
03.875-235	Tightening chuck P 4.5 type, Ø 2.35 mm	0.002
03.875-250	Tightening chuck P 4.5 type, Ø 2.50 mm	0.002
03.875-300	Tightening chuck P 4.5 type, Ø 3.00 mm	0.002
03.875-400	Tightening chuck P 4.5 type, Ø 4.00 mm	0.002

Carriers.



MSA	Size	Kg
03.838	40 x 16 x 12 mm	0.060

Set of 12 small carriers with block.
 Ø 0.25, 0.30, 0.35, 0.40, 0.45, 0.50, 0.65, 0.70, 0.75, 0.85, 0.95 and 1.05 mm.

Belts for the lathes illustrated on previous pages.



MSA	Ø	Length	Kg
03.890-2	2 mm	1 m	0.015
03.890-3	3 mm	1 m	0.015
03.890-4	4 mm	1 m	0.015
03.890-5	5 mm	1 m	0.015
03.890-6	6 mm	1 m	0.015
03.890-7	7 mm	1 m	0.015
03.890-8	8 mm	1 m	0.015
03.890-10	10 mm	1 m	0.015
03.890-12	12 mm	1 m	0.015

Belt in polyurethane.



MSA	Ø	Length	Kg
03.891-4	4 mm	1 m	0.018
03.891-5	5 mm	1 m	0.018
03.891-6	6 mm	1 m	0.018

Green POLYCORD belt.

Riveting stakes and hole plates are in tempered stainless steel. Used for riveting, unriveting or holing small pieces. "V" shape slots are suitable to remove pinions or any other watch components.



MSA		Size	Number of holes	Ø holes	Kg
03.901	(1)	53 x 15 mm	24	0.50...2.20 mm	0.030
03.902	(2)	53 x 15 mm	36	0.50...2.50 mm	0.026

Hardened steel riveting stake with 24 calibrated holes from Ø 0.50 to 2.20 mm or 36 calibrated holes from Ø 0.50 to 2.50 mm.



MSA		Size	Number of holes	Ø holes	Kg
03.903		50 x 15 mm	36	0.50...2.50 mm	0.025

Brass riveting stake with 36 calibrated holes from Ø 0.50 to 2.50 mm.



MSA		Size	Number of holes	Ø holes	Kg
03.904		72 x 15 mm	20	0.50...2.50 mm	0.030

Hardened steel riveting stake, with 20 calibrated holes from Ø 0.50 to 2.50 mm, 2 "V" shape slots and 5 notches of different dimensions.



MSA		Size	Number of holes	Ø holes	Kg
03.905		40 x 40 x 40 mm	36	0.30...10.00 mm	0.378

Hardened steel riveting stake, universal cubic shape, with 36 calibrated holes from Ø 0.30 to 10.00 mm and 16 slots with different shapes and dimensions.

For watches, alarm clocks and wall clocks.



MSA		Size	Number of holes	Ø holes	Kg
03.906		46 x 46 x 15 mm	15	0.80...6.50 mm	0.196

Polished hardened steel riveting stake, hexagonal shape, with 15 calibrated holes from Ø 0.80 to 6.50 mm and 4 slots of different dimensions.

Holes : Ø 0.80 - 1.00 - 1.20 - 1.50 - 2.00 - 2.30 - 2.70 - 3.00 - 3.20 - 3.70 - 4.00 - 4.50 - 5.50 - 6.00 - 6.50 mm.
Slots : 0.30 - 0.50 - 0.70 - 0.90 mm.

High-precision sensitive drilling machine SERVO.



MSA	Voltage	Kg
03.300	220 V	9.500

The SERVO 7150 is a high-speed benchtop micro drilling machine. Easy-to-use, very precise, it is equipped as standard with a spindle taking the B-8 chucks.

- Continuously adjustable speeds by potentiometer integrated in the frame.
- With thyristor-controlled variable speed motor
- Removable protective cover on the belt
- Built-in switch in the frame
- Hardened and rectified spindle
- Drilling lever with adjustable angular position and graduated ring
- Depth micrometric stop
- Front dial indicator for measuring the spindle travel
- Lighting.

Technical data :	
Drilling capacity in steel	3 mm
Continuous spindle speeds	200...20'000 rpm
Spindle travel	38 mm
Distance spindle - column	89 mm
Distance table - spindle nose	0...130 mm
Table area	182 x 300 mm
Total height	342 mm

Optional :

MSA	Item
03.300-A	Self-tightening chuck with chuck holder die, tightening 0...3 mm / Ø 24 x L44 mm

Bench-top drill machine PROXXON®.



MSA	Voltage	Kg
03.301	230 V (50 - 60 Hz)	3.300

Bench-top drill machine PROXXON® TBM 220. Plane-milled worktable made of cast aluminium (220 x 120mm) with adjustable fence and scale as well as threaded holes for securing the MICRO compound table KT 70.

- Solid steel column (20 x 340mm)
- Cast aluminium console with guides and spindle-worked adjustments
- Very high-quality motor, extremely quiet and very durable
- Belt transmission with 3 speeds. The movement of the belts provides 3 speeds and triple torque at low speeds
- Feed lever with adjustable depth scale.

Delivered with 6 tightening chucks Ø 1.00, 1.50, 2.00, 2.40, 3.00 and 3.20 mm.

Technical data :	
- Power supply	230 V (50 - 60Hz)
- Motor power	85 W
- Spindle speeds	1'800, 4'700 and 8'500 rpm
- Throat depth, column to drill spindle	140 mm
- Spindle travel	30 mm
- 3/8" threading for fixing a toothed tightening chuck	

Optional :

MSA	Item
03.301-T	Micro-coordinate table KT 70, 200 x 70 x 42 mm

04



HAMMERS

04 - 2

ANVILS

04 - 4

SAW FRAMES

04 - 5

SAW BLADES

04 - 6

TAPS AND DRAW PLATES

04 - 7

Hammers for watchmaker.



MSA	Head length	Total length	Kg
04.007	35 mm	193 mm	0.020
04.001	50 mm	195 mm	0.052
04.002	60 mm	210 mm	0.052
04.006	67 mm	218 mm	0.050
04.003	70 mm	230 mm	0.052
04.004	80 mm	230 mm	0.123

Hammer with forged polished steel flat head, conic shape on one side and "V" shape for riveting on the other.
 Delivered with a wooden handle, ideal for lightweight precise watch making work.



MSA	Head length	Total length	Kg
04.008	70 mm	230 mm	0.070

Hammer with forged polished steel flat head, conic shape on one side and "V" shape for riveting on the other.
 Delivered with a plastic handle, ideal for lightweight precise watch making work.



MSA	Head length	Total length	Kg
04.010	52 mm	235 mm	0.123

Hammer with cylindrical head made of polished brass Ø 16 mm, flat shape on one side and dome shape on the other.
 Delivered with a wooden handle.



MSA	Head length	Total length	Kg
04.011	52 mm	235 mm	0.110

Hammer with cylindrical head made of polished brass Ø 16 mm, flat shape on one side and dome shape on the other.
 Delivered with a plastic handle.



MSA	Head length	Total length	Kg
04.012	65 mm	230 mm	0.090

Hammer with cylindrical head made of brass Ø 16 mm and 2 inserts in white Delrin (flat/conical).
 Delivered with a synthetic beige handle.

Spare parts :

MSA	Item	Kg
04.012-A	Flat insert in white Delrin®	0.004
04.012-B	Conical insert in white Delrin®	0.004



MSA	Head length	Total length	Kg
04.020	75 mm	230 mm	0.106

Watchmakers hammer for riveting with steel head, flat and round shape (Ø 10 mm) on one side and "V" shape (width 2 mm) on the other.
 Delivered with a wooden handle.

Mallets for watchmaker.



MSA	Head size	Total length	Kg
04.200	Ø 30 x 70 mm	220 mm	0.085

Robust beech wood mallet, ideal for flattening metals without scraping.



MSA	Head size	Total length	Kg
04.210	Ø 30 x Ø 10 x 73 mm	225 mm	0.073

Robust beech wood mallet with conic shape head, ideal for flattening metals without scraping.

Hammer handles.



MSA	Length	Kg
04.102	240 mm	0.060
04.103	260 mm	0.060

Wooden handle for chase hammers, with straight oval shape.



MSA	Head	Length	Kg
04.104	11 x 11 mm	235 mm	0.035
04.105	11 x 13 mm	245 mm	0.038
04.106	11 x 14 mm	255 mm	0.042

Wooden handle for watchmakers' hammer.

ANVILS



MSA	Size	Hardness	Kg
04.061	110 x 68 x 75 mm	55 HRC*	0.670

Anvil with 2 horns, made of hardened and galvanized steel on cast iron base. For forging, riveting or stamping.

* HRC : Hardness Rockwell Scale "C"



MSA	Size	Hardness	Kg
04.062	105 x 30 x 42 mm	55 HRC*	0.550

Bench-anvil with 2 horns, made of forged and hardened steel. For forging, riveting or stamping.

* HRC : Hardness Rockwell Scale "C"



MSA	Size	Hardness	Kg
04.063	60 x 60 x 20 mm	60 HRC*	0.570
04.064	80 x 80 x 20 mm	60 HRC*	1.000
04.065	100 x 100 x 20 mm	60 HRC*	1.570

Square-shaped anvil, made of hardened rectified steel. For forging, riveting or stamping.

* HRC : Hardness Rockwell Scale "C"

FIXED



MSA	Depth	Kg
04.311-075	75 mm	0.140

Rigid steel fixed saw frame with plastic handle.

ADJUSTABLE



MSA	Depth	Kg
04.316-075	75 mm	0.175
04.316-100	100 mm	0.185

Rigid stainless steel adjustable saw frame with plastic handle.
Steel tension screw to tighten the saw blades.

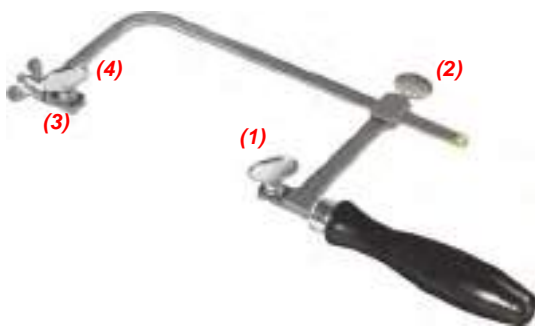

MSA	Depth	Kg
04.315-060	60 mm	0.150
04.315-070	70 mm	0.150
04.315-080	80 mm	0.153
04.315-100	100 mm	0.170
04.315-120	120 mm	0.180
04.315-150	150 mm	0.190
04.315-200	200 mm	0.210

Saw frame made of rigid and resistant steel, with black varnished wooden handle.
Delivered with 1 toothed plate and fixing screws to firmly hold the saw blades in place. Tension screw to tighten the saw blades.

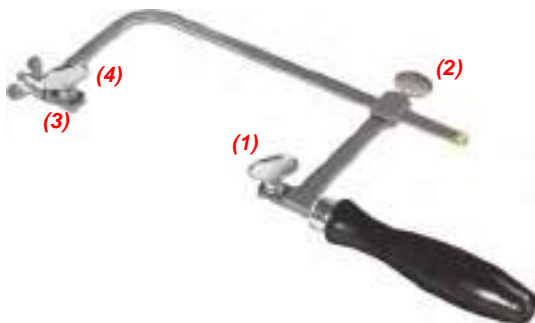

MSA	Depth	Kg
04.310-060	60 mm	0.140
04.310-070	70 mm	0.145
04.310-080	80 mm	0.150
04.310-100	100 mm	0.155
04.310-120	120 mm	0.165

Saw frame made of rigid and resistant steel, with black varnished wooden handle.
Delivered with 1 toothed plate and fixing screws to firmly hold the saw blades in place.

Spare parts for MSA04.310-x and MSA04.315-x :

MSA	Item	Kg
04.310-A	(1) Saw blades screw	0.007
04.310-B	(2) Upper screw	0.005
04.310-C	(3) Fixing plate for saw blades	0.002
04.310-D	(4) Washer for saw blades	0.001

SAW BLADES



MSA	No.	Length	Kg
04.402-2/0	2/0	130	0.018
04.402-0	0	130	0.020
04.402-1	1	130	0.022
04.402-2	2	130	0.028
04.402-3	3	130	0.032
04.402-4	4	130	0.036
04.402-5	5	130	0.042

MSA	No.	Length	Kg
04.402-6	6	130	0.047
04.402-7	7	130	0.056
04.402-8	8	130	0.062
04.402-9	9	130	0.074
04.402-10	10	130	0.083
04.402-11	11	130	0.090
04.402-12	12	130	0.100

Saw blade NIQUA-FIX® for wood.
 Delivered in a bag with 1 gross (144 pieces).
 Note : 2/0 (fine)... 12 (coarse).



MSA	No.	Length	Kg
04.420-8/0	8/0	130	0.019
04.420-7/0	7/0	130	0.019
04.420-6/0	6/0	130	0.019
04.420-5/0	5/0	130	0.019
04.420-4/0	4/0	130	0.019
04.420-3/0	3/0	130	0.019
04.420-2/0	2/0	130	0.019
04.420-0	0	130	0.019

MSA	No.	Length	Kg
04.420-1	1	130	0.019
04.420-2	2	130	0.019
04.420-3	3	130	0.019
04.420-4	4	130	0.019
04.420-5	5	130	0.019
04.420-6	6	130	0.019
04.420-8	8	130	0.019

Saw blade SUPER PIKE® for metal.
 Delivered in a bag with 1 gross (144 pieces).
 Note : 8/0 (fine)... 8 (coarse).



MSA	Kg
04.420-A	0.022

Assortment of saw blades SUPER PIKE® for metal.
 Delivered in a plastic pouch with the numbers 6/0, 4/0, 3/0, 2/0, 1 and 3 (12 pieces per number).

ASSORTMENT



MSA	Ø nominal	Pitch mm	Ø shank mm	Total length mm	Useful length mm	External Ø mm	Ø drilling steel mm	Ø drilling brass mm	Kg
04.524-030	S 0.30	0.080	1.00	22	2.0	0.32	0.24	0.24	0.001
04.524-035	S 0.35	0.090	1.00	22	2.0	0.37	0.28	0.28	0.001
04.524-040	S 0.40	0.100	1.00	22	2.5	0.42	0.33	0.32	0.001
04.524-050	S 0.50	0.125	1.00	22	3.0	0.52	0.43	0.40	0.001
04.524-060	S 0.60	0.150	1.00	22	3.5	0.63	0.51	0.49	0.001
04.524-070	S 0.70	0.175	1.50	25	4.5	0.73	0.59	0.57	0.001
04.524-080	S 0.80	0.200	1.50	25	5.0	0.83	0.67	0.65	0.001
04.524-090	S 0.90	0.225	1.50	25	5.5	0.93	0.75	0.73	0.001
04.524-100	S 1.00	0.250	1.50	25	6.0	1.04	0.83	0.81	0.001
04.524-110	S 1.10	0.250	1.50	25	7.0	1.14	0.93	0.91	0.001
04.524-120	S 1.20	0.250	1.50	25	7.0	1.24	1.03	1.01	0.002
04.524-130	S 1.30	0.300	1.50	25	8.0	1.34	1.09	1.07	0.002
04.524-140	S 1.40	0.300	2.00	30	8.5	1.44	1.19	1.17	0.002
04.524-150	S 1.50	0.300	2.00	30	10	1.54	1.29	1.27	0.002
04.524-160	M 1.60	0.350	2.00	30	10	1.64	1.32	1.30	0.002
04.524-170	M 1.70	0.350	2.00	30	10	1.74	1.42	1.40	0.002
04.524-180	M 1.80	0.350	2.00	30	10	1.84	1.52	1.50	0.002
04.524-200	M 2.00	0.400	3.00	35	13	2.07	1.68	1.65	0.002
04.524-220	M 2.20	0.450	3.00	35	13	2.27	1.84	1.80	0.002
04.524-230	M 2.30	0.400	3.00	35	13	2.37	1.98	1.95	0.002
04.524-240	M 2.40	0.450	3.00	40	15	2.47	2.04	2.00	0.002
04.524-250	M 2.50	0.450	3.00	40	15	2.57	2.14	2.10	0.002
04.524-260	M 2.60	0.450	3.00	40	15	2.67	2.24	2.20	0.002
04.524-300	M 3.00	0.500	4.00	40	16	3.09	2.60	2.50	0.002
04.524-350	M 3.50	0.600	4.00	40	17	3.59	3.01	2.90	0.002
04.524-400	M 4.00	0.700	5.00	50	20	4.10	3.42	3.30	0.002
04.524-450	M 4.50	0.750	5.00	50	20	4.60	3.87	3.75	0.002
04.524-500	M 5.00	0.800	6.00	55	25	5.10	4.35	4.20	0.002
04.524-600	M 6.00	1.000	6.00	55	25	6.12	5.15	5.00	0.002

Machine tap HSS 50/3G NIHS for steel and brass material suitable for through and blind holes. Good break resistance. For lathe and tapping machines.



MSA	Ø nominal	Pitch mm	Ø	Kg
04.526-02	M2.5	0.25 mm	10 mm (L 70 mm)	0.040
04.526-04	M3.0	0.35 mm	10 mm (L 70 mm)	0.040

Tap HSS on support key.

TAPS AND DRAW PLATES



MSA	Ø nominal	Pitch mm	Kg
04.525-01	M 2.50	0.20 mm	0.002
04.525-02	M 2.50	0.25 mm	0.002
04.525-03	M 2.80	0.20 mm	0.002
04.525-04	M 3.00	0.35 mm	0.002

Tap HSS for through holes. Good break resistance.



MSA	Number	Ø nominal	Kg
04.550-S0.60	40/3G	S 0.60	0.002
04.550-S0.70	40/3G	S 0.70	0.002
04.550-S0.90	40/3G	S 0.90	0.002
04.550-S1.00	40/3G	S 1.00	0.002
04.550-S1.10	40/3G	S 1.10	0.002
04.550-S1.50	40/3G	S 1.50	0.002

Machine tap HSS for brass.



MSA	Ø nominal	Kg
04.542-030	S 0.30	0.002
04.542-035	S 0.35	0.002
04.542-040	S 0.40	0.002
04.542-050	S 0.50	0.002
04.542-060	S 0.60	0.002
04.542-070	S 0.70	0.002
04.542-080	S 0.80	0.002
04.542-090	S 0.90	0.002
04.542-100	S 1.00	0.002
04.542-110	S 1.10	0.002
04.542-120	S 1.20	0.002

Tap for blind holes.



MSA	External Ø x thickness mm	Ø nominal	Pitch mm	Kg
04.541-M1.20	16 x 5	M 1.20	0.25	0.006

ASCO drawplate HSS.

05

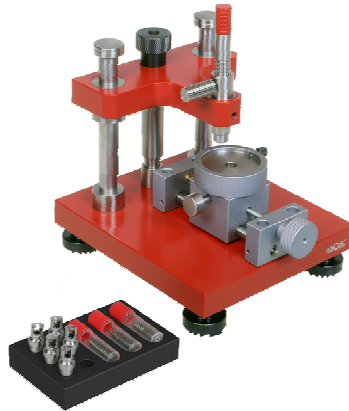

HANDS FITTING TOOLS

05 - 2

HANDS FITTING PRESSES

05 - 5

HANDS REMOVING PRESSES

05 - 10

HANDS REMOVING TOOLS

05 - 12



ASSORTMENT

MSA	Size	Kg
05.023	132 x 63 x 30 mm	0.107

Assortment of hands fitting tools equipped with Delrin® driven stakes. Knurled handle in anodised aluminium. Delivered in a wooden box.

Contents :

- 1x MSA05.010 Hands fitting tool, Ø 0.50 - 1.00 mm
- 1x MSA05.019 Hands fitting tool, Ø 0.65 - 1.10 mm
- 1x MSA05.011 Hands fitting tool, Ø 0.80 mm - flat
- 1x MSA05.012 Hands fitting tool, Ø 1.50 - 2.00 mm



ASSORTMENT

MSA	Kg
05.020	?

Assortment of hands fitting tools, equipped with Delrin® driven stakes. Knurled handle in anodised aluminium. Delivered in 1 plastic pouch.

Contents :

- 1x MSA05.012 Hands fitting tool, Ø 1.50 - 2.00 mm
- 1x MSA05.011 Hands fitting tool, Ø 0.80 mm - flat
- 1x MSA05.019 Hands fitting tool, Ø 0.65 - 1.10 mm
- 1x MSA05.010 Hands fitting tool, Ø 0.50 - 1.00 mm



ASSORTMENT

MSA	Kg
05.024	?

Assortment of hands fitting tools, equipped with Delrin® driven stakes. Knurled handle in anodised aluminium. Delivered in 1 plastic pouch.

Contents :

- 1x MSA05.012 Hands fitting tool, Ø 1.50 - 2.00 mm
- 1x MSA05.019 Hands fitting tool, Ø 0.65 - 1.10 mm



Ø 0.80 mm

MSA	Length	Kg
05.011	112 mm	0.010

Hands fitting tool with Delrin® driven stakes. Knurled handle in anodised aluminium.

Spare parts :

MSA	Item	Kg
05.011-A	Flat stake	0.001
05.011-B	Stake Ø hole 0.80 mm	0.001



Ø 0.50 mm

Ø 1.00 mm

MSA	Length	Kg
05.010	112 mm	0.010

Hands fitting tool with Delrin® driven stakes. Knurled handle in anodised aluminium.

Spare parts :

MSA	Item	Kg
05.010-A	Stake Ø hole 0.50 mm	0.001
05.010-B	Stake Ø hole 1.00 mm	0.001



Ø 0.65 mm

Ø 1.10 mm

MSA	Length	Kg
05.019	112 mm	0.010

Hands fitting tool with Delrin® driven stakes. Knurled handle in anodised aluminium.

Spare parts :

MSA	Item	Kg
05.019-A	Stake Ø hole 0.65 mm	0.001
05.019-B	Stake Ø hole 1.10 mm	0.001



Ø 2.00 mm

Ø 1.50 mm

MSA	Length	Kg
05.012	112 mm	0.010

Hands fitting tool with Delrin® driven stakes. Knurled handle in anodised aluminium.

Spare parts :

MSA	Item	Kg
05.012-A	Stake Ø hole 1.50 mm	0.001
05.012-B	Stake Ø hole 2.00 mm	0.001



MSA	Kg
05.031	0.155

Hands fitting tool on a rotating base.
Delivered with 8 PEEK tips and 1 protective cap.

PEEK (polyetheretherketone phenylene) is a polymer with different properties and high performance used, among others, in the aerospace industry.

- Very good resistance to solvents
- Stability over time
- Doesn't mark the parts.

Spare parts :

MSA	Item	Kg
05.031-0	PEEK flat tip, Ø ext. 2.00 mm	0.001
05.031-0.30	PEEK tip Ø int. 0.30, Ø ext. 2.50 mm	0.001
05.031-0.80	PEEK tip Ø int. 0.80, Ø ext. 2.60 mm	0.001
05.031-0.95	PEEK tip Ø int. 0.95, Ø ext. 2.80 mm	0.001
05.031-1.10	PEEK tip Ø int. 1.10, Ø ext. 2.90 mm	0.001
05.031-1.35	PEEK tip Ø int. 1.35, Ø ext. 3.00 mm	0.001
05.031-1.50	PEEK tip Ø int. 1.50, Ø ext. 3.20 mm	0.001
05.031-2.10	PEEK tip Ø int. 2.10, Ø ext. 3.50 mm	0.001
05.031-E	PEEK protective cap	0.001
05.031-M	(1) Handle	0.024
05.031-S	Rotating base	0.098



Fitting watch hands, without damaging the dial and the hands are delicate operations that guarantee the aesthetics of the watch.

An ideal hands press for any after-sales service jobs.



MSA	Size	Kg
05.021	70 x 70 x 65 mm	0.400

Hands fitting press for wrist and pocket watches, for a quick and efficient job. It allows a precise control by holding the die vertically while pressing on the hand. Nice finish in steel and aluminium.

Delivered with 8 Delrin® screw-on stakes.

Spare parts :

MSA	Item	Kg
05.017-01	(1) Broach	0.009
05.017-02	Spring	0.002
05.017-A	Stake Ø 0.50 mm	0.002
05.017-B	Stake Ø 0.70 mm	0.002
05.017-C	Stake Ø 0.90 mm	0.002
05.017-D	Stake Ø 1.20 mm	0.002
05.017-E	Stake Ø 1.50 mm	0.002
05.017-F	Stake Ø 1.70 mm	0.002
05.017-G	Flat stake	0.002
05.017-H	Conical stake	0.002



MSA	Size	Kg
05.022	105 x 70 x 72 mm	0.520

Hands fitting press with 3 broaches for wrist and pocket watches without any broach replacement.

Delivered with 8 Delrin® screw-on stakes.

Spare parts :

MSA	Item	Kg
05.017-01	(1) Broach	0.009
05.017-02	Spring	0.002
05.017-A	Stake Ø 0.50 mm	0.002
05.017-B	Stake Ø 0.70 mm	0.002
05.017-C	Stake Ø 0.90 mm	0.002
05.017-D	Stake Ø 1.20 mm	0.002
05.017-E	Stake Ø 1.50 mm	0.002
05.017-F	Stake Ø 1.70 mm	0.002
05.017-G	Flat stake	0.002
05.017-H	Conical stake	0.002



ASSORTMENT

MSA	Kg
05.017-03	0.026

Assortment with 1 broach and 8 Delrin® screw-on stakes for presses MSA05.021 and MSA05.022.



MSA	Size	Kg
05.050	160 x 100 x 130 mm	1.440

Hands fitting press, 4 broaches.
 Delivered with stakes equipped with PEEK tips (doesn't mark the hands).
 For hands : hours (Ø 1.35 mm), minutes (Ø 0.95 mm), seconds (Ø 0.30 mm) and 1 decentred stake.

See following pages for other compatible stakes.

Spare parts :

MSA	Item	Kg
05.050-BA	Adjustable stop ringDE	0.010
05.050-BR	Broach with head	0.018
05.050-RE	Spring for broach	0.002

Accessory :

MSA	Item	Kg
05.050-P	Decentred adaptor for movement holder. Base Ø 31 mm	0.105



High precision hands fitting press with revolving head to avoid changing broaches, ideal for production series. Each broach is equipped with a knurled ring for fine height adjustment. Suitable for movement holder MSA09.010-xx Ø 31 mm (see chapter 09).



MSA	Tips	Use	Kg
05.109	Steel	For H/M hands	1.350
05.114	PEEK	For H/M hands	1.350

High precision hand fitting press, with 2 hardened steel broaches and 2 stakes Ø 1.35 - 0.95 mm.



MSA	Tips	Use	Kg
05.110	Steel	For H/M/S hands	1.475
05.115	PEEK	For H/M/S hands	1.475

High precision hand fitting press, with 3 hardened steel broaches and 3 stakes Ø 1.35 - 0.95 - 0.30 mm.



MSA	Tips	Use	Kg
05.111	Steel	For H/M/decentred Sec hands	1.455
05.116	PEEK	For H/M/decentred Sec hands	1.455

High precision hand fitting press, with 3 hardened steel broaches and 3 stakes Ø 1.35 - 0.95 mm - decentred.



MSA	Tips	Use	Kg
05.112	Steel	For H/M/S/Date hands	1.585
05.117	PEEK	For H/M/S/Date hands	1.585

High precision hand fitting press, with 4 hardened steel broaches and 4 stakes Ø 1.35 - 0.95 - 0.30 - 2.10 mm.

Accessories for use with the presses illustrated above.



MSA	Kg
05.015-R	0.010

Table to set counter.



MSA	Kg
05.015-P	0.010

Decentred adaptor for movement holder.



Other accessories :

MSA	Item	Kg
05.110-A	(1) Stop ring, height 18 mm	0.008
05.110-B	Stop ring, height 12 mm	0.007
05.110-S	Spring for broach	0.002
05.118	Broach with spring	0.015
05.119	Broach with groove and spring	0.015
05.119-A	Simple broach	0.013



MSA	Tips	Ø hole	Kg
05.110-03	Steel	0.30 mm	0.002
05.110-04	Steel	0.95 mm	0.002
05.110-09	Steel	1.10 mm	0.002
05.110-05	(1) Steel	1.35 mm	0.002
05.110-08	Steel	1.50 mm	0.002
05.110-07	Steel	1.70 mm	0.002
05.110-06	Steel	2.10 mm	0.002
05.110-01	(2) Steel	7.50 mm (Length)	0.004
05.110-02	Steel	Flat	0.002

Spare stainless steel stakes for presses MSA05.050, MSA05.109, MSA05.110, MSA05.111 and MSA05.112. Other diameters available upon request.

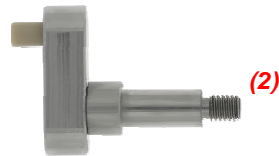

MSA	Tips	Ø hole	Kg
05.114-03	PEEK	0.30 mm	0.002
05.114-14	PEEK	0.40 mm	0.002
05.114-15	PEEK	0.50 mm	0.002
05.114-16	PEEK	0.55 mm	0.002
05.114-17	PEEK	0.75 mm	0.002
05.114-18	PEEK	0.85 mm	0.002
05.114-04	PEEK	0.95 mm	0.002
05.114-19	PEEK	1.05 mm	0.002
05.114-09	PEEK	1.10 mm	0.002
05.114-20	PEEK	1.15 mm	0.002
05.114-21	PEEK	1.25 mm	0.002
05.114-05	(1) PEEK	1.35 mm	0.002
05.114-08	PEEK	1.50 mm	0.002
05.114-22	PEEK	1.55 mm	0.002
05.114-23	PEEK	1.65 mm	0.002
05.114-07	PEEK	1.70 mm	0.002
05.114-24	PEEK	1.80 mm	0.002
05.114-25	PEEK	1.95 mm	0.002
05.114-06	PEEK	2.10 mm	0.002
05.114-13	PEEK	3.00 mm	0.002
05.114-01	(2) PEEK	7.50 mm (Length)	0.004
05.114-02	PEEK	Flat	0.002

Spare stakes with PEEK tip for presses MSA05.050, MSA05.114, MSA05.115, MSA05.116 and MSA05.117. Other diameters available upon request.



MSA	Tips	Ø hole	Kg
05.111-03	Delrin®	0.30 mm	0.002
05.111-12	Delrin®	0.60 mm	0.002
05.111-04	Delrin®	0.95 mm	0.002
05.111-09	Delrin®	1.10 mm	0.002
05.111-11	Delrin®	1.20 mm	0.002
05.111-05	Delrin®	1.35 mm	0.002
05.111-08	Delrin®	1.50 mm	0.002
05.111-10	Delrin®	1.60 mm	0.002
05.111-07	Delrin®	1.70 mm	0.002
05.111-06	Delrin®	2.10 mm	0.002
05.111-13	Delrin®	3.00 mm	0.002
05.111-01	Delrin®	7.50 mm (Length)	0.004
05.111-02	Delrin®	Flat	0.002

Spare stakes with Delrin® tip for presses MSA05.050, MSA05.109, MSA05.110, MSA05.111 and MSA05.112. Other diameters available upon request.

High precision hands fitting press equipped with 2 adjustable and interchangeable broaches, ideal for production series. Suitable for movement holder MSA09.010-xx (see chapter 09).



MSA	Use	Kg
05.100	For hour and minute hands	0.780

High precision hands fitting press with 2 adjustable and interchangeable broaches.

Base Ø 31 mm.

See also movement holders MSA 09.010-xx (chapter 09).

Spare parts :

MSA	Item	Kg
05.101-A	Adjustable broach with white head for minute hands, Ø hole 1.00 mm	0.019
05.101-B	Adjustable broach with black head for hour hands, Ø hole 1.20 mm	0.019



MSA	Use	Kg
05.101	For hour and minute hands	1.260

High precision hands fitting press with 2 adjustable and interchangeable broaches. Revolving head to avoid broach changing.

Base Ø 31 mm.

See also movement holders MSA 09.010-xx (chapter 09).

Spare parts :

MSA	Item	Kg
05.101-A	Adjustable broach with white head for minute hands, Ø hole 1.00 mm	0.019
05.101-B	Adjustable broach with black head for hour hands, Ø hole 1.20 mm	0.019

Accessories for presses MSA05.100 and MSA05.101.



MSA	Kg
05.101-C	0.019

Simple broach with red head for second hands, flat not pierced.

Hands removing press, without contact with the dial.

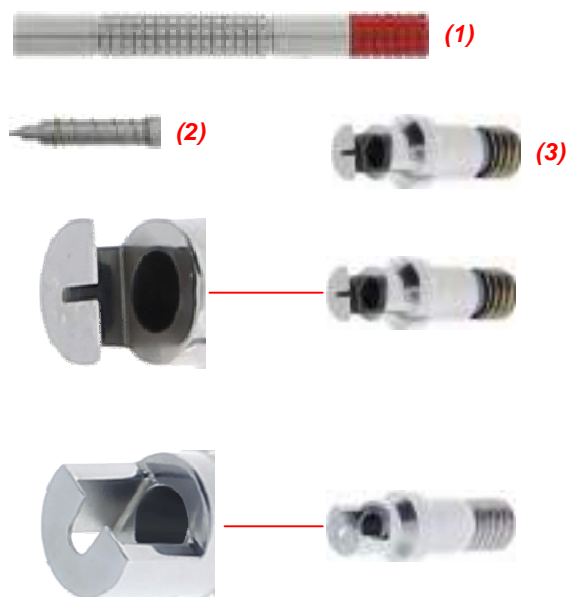

MSA	Size	Kg
05.129	80 x 80 x 85 mm	0.700

Hands removing press, without contact with the dial.
This press allows removing safely the hands fitted on dial, guaranteeing their extraction without damaging the dial.

Contents :

- 1 press MSA05.129-01
- 1 hand tool MSA05.128-02
- 1 base MSA05.129-02 for extractors and pins
- 1 removable plate
- 3 extractors MSA05.129-060, MSA05.129-150 and MSA05.129-250
- 3 pins MSA05.128-015, MSA05.128-060 and MSA05.128-100.

Spare parts :

MSA	Item	Kg
05.128-015	Pin with spring Ø 0.15 mm	0.002
05.128-02	(1) Hand tool	0.020
05.128-060	(2) Pin with spring Ø 0.60 mm	0.002
05.128-100	Pin with spring Ø 1.00 mm	0.002
05.129-01	Press only	0.660
05.129-02	Base only	0.090
05.129-060	(3) Hands extractor, notch 0.60 mm	0.003
05.129-150	Hands extractor, notch 1.50 mm	0.003
05.129-250	Hands extractor, notch 2.50 mm	0.003

Optional extractors :

MSA	Item	Kg
05.129-060C	Counter hands extractor, notch 0.60 mm	0.003
05.129-085	Hands extractor, notch 0.85 mm	0.003
05.129-100	Hands extractor, notch 1.00 mm	0.003
05.129-200	Hands extractor, notch 2.00 mm	0.003

Optional extractors with columns :

MSA	Item	Kg
05.128-B	Hands extractor with columns, 0.60 x 3.80 mm	0.003
05.128-C	Hands extractor with columns, 1.45 x 3.80 mm	0.003
05.128-D	Hands extractor with columns, 2.10 x 4.70 mm	0.003

Other sizes of extractors upon request.

Accessory :

MSA	Item	Kg
05.129-E	Blind hands and counter hands extractor	0.065

Hands removing press with fine adjustment, without contact with the dial.

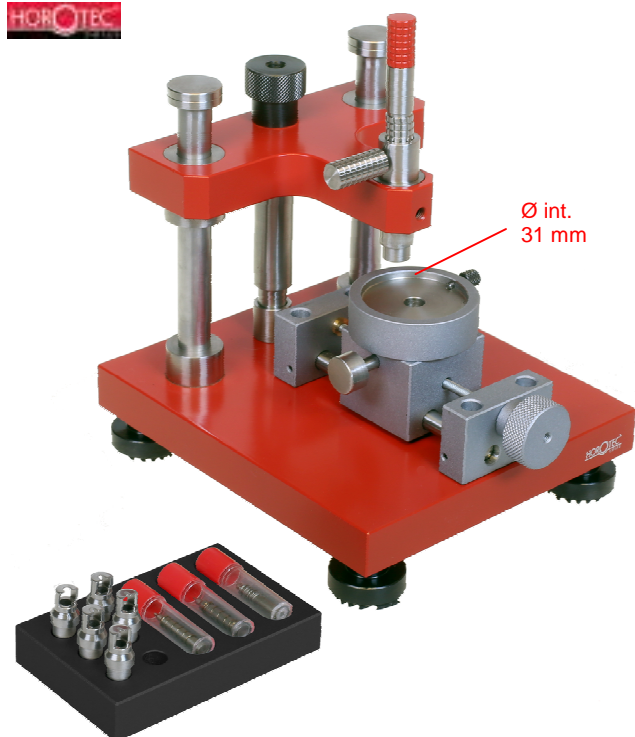

MSA	Size	Kg
05.131	110 x 125 x 125 mm	1.875

Hands removing press with fine adjustment, without contact with the dial.

This press allows removing safely the hands fitted on dial, guaranteeing their extraction without damaging the dial.

Contents :

- 1 press MSA05.131-P
- 1 hand tool MSA05.128-02
- 1 base MSA05.129-02 for extractors and pins
- 5 extractors MSA05.129-060, MSA05.129-060C, MSA05.129-150, MSA05.129-200 and MSA05.129-250
- 3 pins MSA05.128-015, MSA05.128-060 and MSA05.128-100.

Spare parts :

MSA	Item	Kg
05.128-015	Pin with spring Ø 0.15 mm	0.002
05.128-02	(1) Hand tool	0.020
05.128-060	(2) Pin with spring Ø 0.60 mm	0.002
05.128-100	Pin with spring Ø 1.00 mm	0.002
05.129-02	Base only	0.090
05.129-060	(3) Hands extractor, notch 0.60 mm	0.003
05.129-060C	Counter hands extractor, notch 0.60 mm	0.003
05.129-150	Hands extractor, notch 1.50 mm	0.003
05.129-200	Hands extractor, notch 2.00 mm	0.003
05.129-250	Hands extractor, notch 2.50 mm	0.003
05.131-P	Press only	1.720

Optional extractors :

MSA	Item	Kg
05.129-085	Hands extractor, notch 0.85 mm	0.003
05.129-100	Hands extractor, notch 1.00 mm	0.003

Optional extractors with columns :

MSA	Item	Kg
05.128-B	Hands extractor with columns, 0.60 x 3.80 mm	0.003
05.128-C	Hands extractor with columns, 1.45 x 3.80 mm	0.003
05.128-D	Hands extractor with columns, 2.10 x 4.70 mm	0.003

Other sizes of extractors upon request.



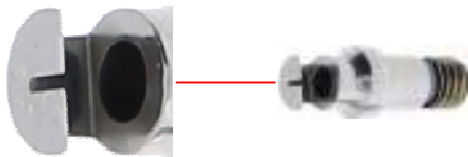
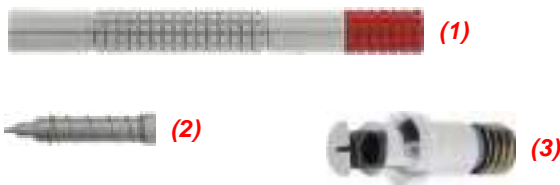

MSA	Size	Kg
05.128	109 x 69 x 15 mm	0.400

Hands removing tool, without contact with the dial.

Contents :

- 1 hand tool MSA05.128-02
- 1 base MSA05.128-01 for extractors and pins
- 3 extractors MSA05.129-060, MSA05.129-150 and MSA05.129-250
- 3 pins MSA05.128-015, MSA05.128-060 and MSA05.128-100.

Spare parts :

MSA	Item	Kg
05.128-01	Base only	0.225
05.128-015	Pin with spring Ø 0.15 mm	0.002
05.128-02	(1) Hand tool	0.020
05.128-060	(2) Pin with spring Ø 0.60 mm	0.002
05.128-100	Pin with spring Ø 1.00 mm	0.002
05.129-060	(3) Hands extractor, notch 0.60 mm	0.003
05.129-150	Hands extractor, notch 1.50 mm	0.003
05.129-250	Hands extractor, notch 2.50 mm	0.003

Optional extractors :

MSA	Item	Kg
05.129-060C	Counter hands extractor, notch 0.60 mm	0.003
05.129-085	Hands extractor, notch 0.85 mm	0.003
05.129-100	Hands extractor, notch 1.00 mm	0.003
05.129-200	Hands extractor, notch 2.00 mm	0.003

Optional extractors with columns :

MSA	Item	Kg
05.128-B	Hands extractor with columns, 0.60 x 3.80 mm	0.003
05.128-C	Hands extractor with columns, 1.45 x 3.80 mm	0.003
05.128-D	Hands extractor with columns, 2.10 x 4.70 mm	0.003

Other sizes of extractors upon request.



PAIR

MSA	Tips width	Length	Kg
05.009	1.00 mm	105 mm	0.020

Pair of hand levers with varnished aluminium handles, for sweep second hands and small counter hands of chronometers.
Delivered with 2 dial protectors MSA70.004.



PAIR

MSA	Tips width	Length	Kg
05.007	2.50 mm	105 mm	0.022

Pair of hand levers with varnished aluminium handles, for wrist watches.
Delivered with 2 dial protectors MSA70.004.



PAIR

MSA	Tips width	Length	Kg
05.013	3 mm	115 mm	0.015

Pair of hand levers with varnished aluminium handles and polished work surface.
Delivered with 2 dial protectors MSA70.004.



PAIR

MSA	Tips width	Length	Kg
05.008	4 mm	105 mm	0.042

Pair of hand levers with varnished aluminium handles, for pocket watches.
Delivered with 2 dial protectors MSA70.004.



PAIR

MSA	Tips width	Length	Kg
05.014	10 mm	115 mm	0.020

Pair of hand levers with varnished aluminium handles and polished work surface, for alarm and wall clocks.
Delivered with 2 dial protectors MSA70.004.



PAIR

MSA	Tips width	Length	Kg
05.107	2.50 mm	105 mm	0.020

Pair of hand levers with anodised grey aluminium knurled handles.
Delivered with 2 dial protectors MSA70.004 in 1 plastic pouch.



MSA	Length	Kg
70.004	25 x 38 x 0.20	0.001

Plastic dial protector to be used during hands extraction.
Avoids scratching the dial with the hand levers illustrated above.



ZBG	Length	Kg
30636-1	98 mm	0.020

PRESTO hands remover for wrist watches, equipped with buffer to avoid damaging the dial.

06/07



UNIVERSAL PRESSES FOR SCREW-ON / SNAP-ON DIES

07 - 2

ASSORTMENTS OF SCREW-ON DIES

07 - 9

ASSORTMENTS OF SNAP-ON DIES

07 - 15

PRESSES FOR SCREW / UNSCREW CASE BACKS

07 - 17

TOOLS FOR SCREW / UNSCREW CASE BACKS

07 - 29

TOOLS FOR SNAP-ON CASE BACKS

07 - 34

OTHER TOOLS

07 - 39

Rack-press.



MSA	Size	Kg
07.060	200 x 200 x 380 mm	8.140

The strongest rack-press in its class, ideally suited for all work requiring high force or for production work, series (adjustable stop ensuring repeatability of the press in).

Its extreme robustness as well as its long travel make it a perfect versatile press. Its one-piece design guarantees an optimal alignment.

- Reaming table/broach : Ø 10 mm
- Travel 110 mm.

*Delivered with 2 adaptors (lower and upper) compatible with all Horotec® screw-on dies (thread Ø 6 mm).
See pages 07-9...07-14.*

Spare parts :

MSA	Item	Kg
07.060-A	Adjustment screw	0.010
07.060-B	Ring on adjustment screw	0.003
07.060-C	Maintaining screw of the broach die support	0.012
07.060-D	Tightening knob of the lower die support	0.020
07.170-A	Lower and upper adaptor for screw-on dies	0.011

Accessory :

MSA	Item	Kg
10.523	Pin punch support, Ø 10 x L 40 mm	0.019



MSA	Size	Kg
07.170	160 x 150 x 220 mm	7.000

Rack-press for right or left handed users (the lever is removable and can be placed on the right or on the left according to the user).

For heavy-duty jobs in production or after sales service.

The broach is pierced and equipped with an air connector Ø 6 mm on the top to eventually handle the components by vacuum.

- Travel 110 mm.

*Delivered with 2 adaptors (lower and upper) compatible with all Horotec® screw-on dies (thread Ø 6 mm).
See pages 07-9...07-14.*

Spare part :

MSA	Item	Kg
07.170-A	Lower and upper adaptor for screw-on dies	0.011

Accessory :

MSA	Item	Kg
10.523	Pin punch support, Ø 10 x L 40 mm	0.019



Left-handed version.

Right-handed version.



MSA	Broach	Size	Kg
06.135	Simple	80 x 225 x 180 mm	1.980

Stable precision press, equipped with a head and a massive aluminium base mounted on 2 robust steel columns. The frontal part V shaped, allows the glass fitting without removing the bracelets. The steel axle slides freely in a self-lubricated sleeve for maximum precision: this is essential for fitting back cases, glasses or bezels without scratching. The end of the threaded axle (Ø 6 mm) is specially made for screwing all dies in a perfect horizontal position. Changing dies becomes easier. The lever covered with an anti-skid rubber and equipped with a return spring, which allows a fine control of fitting pressure.

Compatible with all Horotec® screw-on dies (thread Ø 6 mm).
See pages 07-9...07-14.

FOR SCREW-ON DIES



MSA	Broach	Kg
06.136	Simple	2.800

Precision press MSA06.135 (see above), delivered with 4 assortments of Delrin® screw-on dies MSA06.520, MSA06.521, MSA06.522 and MSA07.106 (43 pieces).

Compatible with all Horotec® screw-on dies (thread Ø 6 mm).
See pages 07-9...07-14.

FOR SCREW-ON DIES





MSA	Broach	Size	Kg
06.150	Double	80 x 215 x 185 mm	2.685

This precision rack-press is provided with a small slide that allows to block or to free the toothed rack. The watchmaker thus has an exceptional tool for fitting glasses and bezels, closing watch cases and maintain the glass on the watch case during joining time. After screwing the die on the die holder, one can determine the best way to proceed :

- free toothed rack (slide ahead) :
For usual work on steel watch cases, thick or sturdy ; apply pressure on the lever provided with an anti-skid rubber. The return spring and the fixed handle allow for careful adjustment of pressure upon use.

- blocked toothed rack (slide behind) :
For delicate work on gold cases, thin or delicate; pull the slide to lock the toothed rack in the desired position, then use the spanner, to fit the glass or the case back; with each rotation the die goes down about 1.5 mm. The fitting precision can be perfectly controlled.

Compatible with all Horotec® screw-on dies (thread Ø 6 mm).
See pages 07-9...07-14.

FOR SCREW-ON DIES



MSA	Broach	Kg
06.151	Double	3.120

Precision rack-press MSA06.150 (see above), delivered with 4 assortments of Delrin® screw-on dies MSA06.520, MSA06.521, MSA06.522 and MSA07.106 (43 pieces).

Compatible with all Horotec® screw-on dies (thread Ø 6 mm).
See pages 07-9...07-14.

FOR SCREW-ON DIES





MSA	Broach	Kg
06.152	Double	6.640

Precision rack-press MSA06.150 (see previous page), delivered in a wooden box. (1)
 - 4 assortments of Delrin® screw-on dies (43 pieces) : MSA06.520, MSA06.521, MSA06.522 and MSA07.106. Delivered in a wooden box. (2)
 Compatible with all Horotec® screw-on dies (thread Ø 6 mm).
 See pages 07-9...07-14.

FOR SCREW-ON DIES



Items of the wooden box MSA06.052 (delivered without dies) :

MSA	Item	Kg
06.050	(1) Empty wooden box for press, 240x220x90 mm	0.860
06.052	(2) Empty wooden box for dies, 240x220x160 mm	2.220
06.051	(3) Wooden box with 80 dies, 240x220x160 mm	3.540
-	-	-
06.051-01	(4) Lower base	0.235
06.051-02	(5) Upper base	0.297
06.051-03	(6) Spacer	0.124
06.051-04	(7) Tray for dies assortments MSA07.106 and MSA07.108	0.264
06.051-05	(8) Tray for dies assortments MSA06.521 and MSA06.525	0.264
06.051-06	(9) Tray for dies assortments MSA06.522 and MSA06.523	0.260
06.051-07	(10) Tray for dies assortments MSA06.520 and MSA06.524	0.263
06.051-08	(11) Tray for dies assortments MSA06.526 and MSA06.530	0.262

Details of the dies assortments, see pages 07-9...07-14.



(4)



(5)



(6)

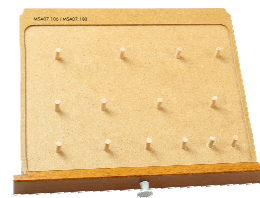

(7)



(8)



(9)



(10)



(11)

HOROTEC® press provided with SNAP-ON dies.



FOR SNAP-ON DIES

MSA	Broach	Size	Kg
07.110	Simple	80 x 60 x 130 mm	0.580

Small press for closing snap-on case backs, equipped with a simple threaded broach.

Compatible with all Horotec® snap-on reversible dies (see pages 07-15...07-16).

Delivered with an assortment of 6 Delrin® snap-on dies MSA07.111.

Spare parts :

MSA	Item	Kg
07.110-A	(1) Upper die support	0.002
07.110-B	(2) Upper plate	0.062
07.110-J	(3) O'Ring gasket for upper die support	0.001
07.110-P	(4) Broach with handle	0.040

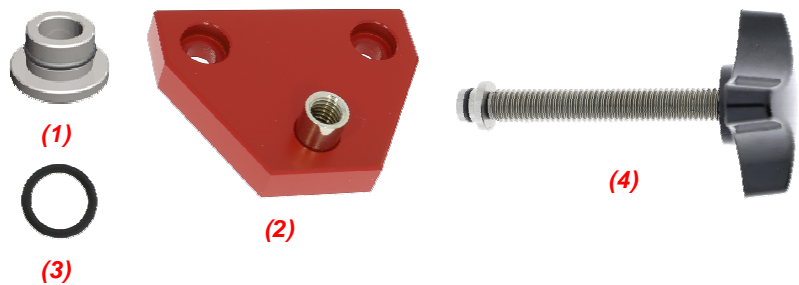

HOROTEC® press provided with SCREW-ON dies.

Advantage : a wide variety of dies is available with a standard thread of 6 mm.



FOR SCREW-ON DIES

MSA	Broach	Size	Kg
07.105	Simple	80 x 60 x 135 mm	0.630

Small press for closing snap-on case backs, equipped with a simple threaded broach.

Compatible with all Horotec® screw-on dies (thread Ø 6 mm). See pages 07-9...07-14.

Delivered with an assortment of 9 Delrin® screw-on dies MSA07.106.

Spare parts :

MSA	Item	Kg
07.105-A	(1) Upper dies holder	0.008
07.105-P	(2) Broach with handle	0.034
07.105-V	(3) Fixing screw for upper dies holder	0.001

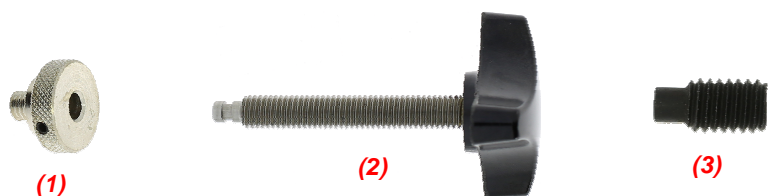

HOROTEC® presses for both SCREW-ON and SNAP-ON dies.

Advantage : a wide variety of screw-on dies is available with a standard thread of 6 mm and snap-on dies Ø 8 mm (upper dies) and Ø 5 mm (lower dies). See pages 07-9...07-16.



For screw-on dies



FOR SCREW-ON AND SNAP-ON DIES

MSA	Size	Kg
07.131	110 x 95 x 210 mm	1.575

Small sized press, suitable for screw-on and snap-on dies, even large diameters. Compatible with all Horotec® dies. See pages 07-9...07-16.

Delivered with an assortment of 12 Delrin® screw-on dies for fitting snap-on case backs.

Press MSA07.131 contents :

MSA	Item	Kg
07.104	assortment of 12 screw-on dies	0.180
07.130	Press	1.000
07.130-A	(1) Upper adaptor for screw-on dies	0.012
07.130-B	(2) Reversible lower adaptor for screw-on and snap-on dies	0.008
07.130-C	(4) Broach with wheel	0.185

Assortment MSA07.104 contents :

MSA	Item	Kg
07.106-17	Screw-on die, Ø 17 mm	0.004
07.106-1921	Screw-on die, Ø 19-21 mm	0.005
07.106-2225	Screw-on die, Ø 22-25 mm	0.006
07.106-2629	Screw-on die, Ø 26-29 mm	0.008
07.106-3033	Screw-on die, Ø 30-33 mm	0.010
07.106-3437	Screw-on die, Ø 34-37 mm	0.012
07.106-3841	Screw-on die, Ø 38-41 mm	0.015
07.106-4245	Screw-on die, Ø 42-45 mm	0.017
07.106-4648	Screw-on die, Ø 46-48 mm	0.020
07.106-4950	Screw-on die, Ø 49-50 mm	0.022
07.106-5255	Screw-on die, Ø 52-55 mm	0.025
07.106-U	Universal screw-on inferior die, Ø 45 mm	0.014

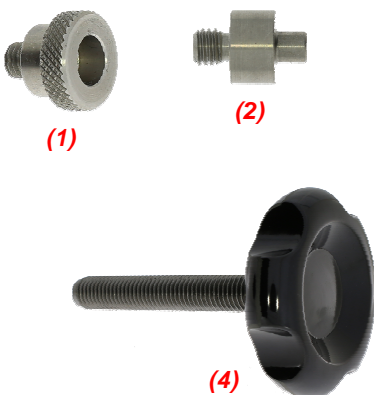



For screw-on dies

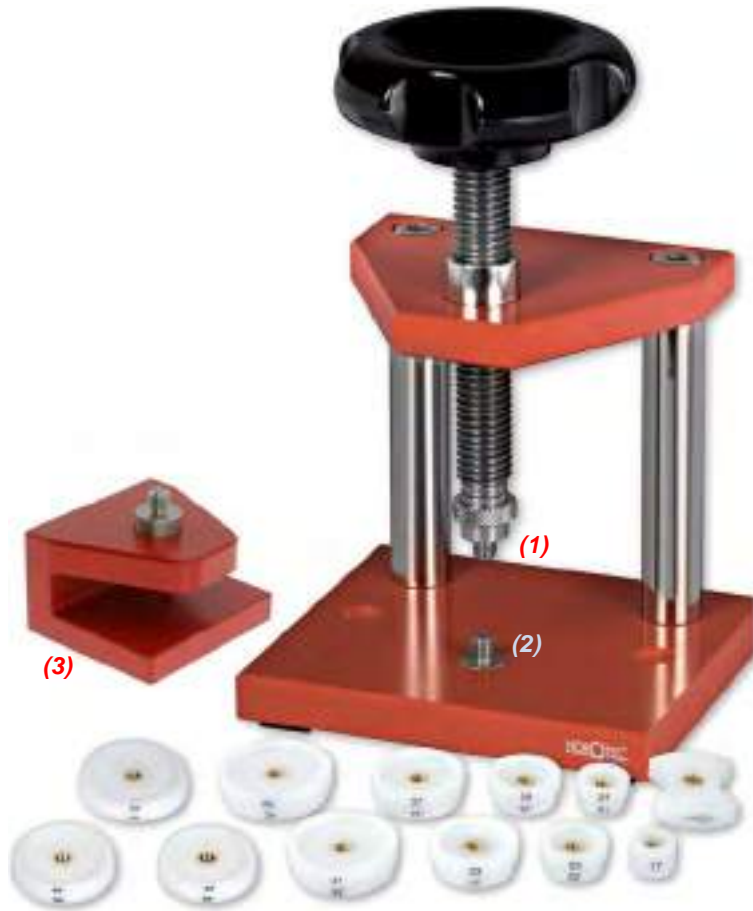

FOR SCREW-ON AND SNAP-ON DIES

MSA	Size	Kg
07.132	110 x 95 x 210 mm	1.460

Small sized press, suitable for screw-on and snap-on dies, even large diameters. Compatible with all Horotec® dies. See pages 07-9...07-16.

Delivered with an assortment of 12 Delrin® screw-on dies for fitting snap-on case backs and 1 support for closed bracelet MSA07.160-A.

Press MSA07.132 contents :

MSA	Item	Kg
07.104	assortment of 12 screw-on dies	0.180
07.130	Press	1.000
07.130-A	(1) Upper adaptor for screw-on dies	0.012
07.130-B	(2) Reversible lower adaptor for screw-on and snap-on dies	0.008
07.130-C	(4) Broach with wheel	0.185
07.160-A	(3) Support for closed band	0.125

Assortment contents MSA07.104 :

MSA	Item	Kg
07.106-17	Screw-on die, Ø 17 mm	0.004
07.106-1921	Screw-on die, Ø 19-21 mm	0.005
07.106-2225	Screw-on die, Ø 22-25 mm	0.006
07.106-2629	Screw-on die, Ø 26-29 mm	0.008
07.106-3033	Screw-on die, Ø 30-33 mm	0.010
07.106-3437	Screw-on die, Ø 34-37 mm	0.012
07.106-3841	Screw-on die, Ø 38-41 mm	0.015
07.106-4245	Screw-on die, Ø 42-45 mm	0.017
07.106-4648	Screw-on die, Ø 46-48 mm	0.020
07.106-4950	Screw-on die, Ø 49-50 mm	0.022
07.106-5255	Screw-on die, Ø 52-55 mm	0.025
07.106-U	Universal screw-on inferior die, Ø 45 mm	0.014

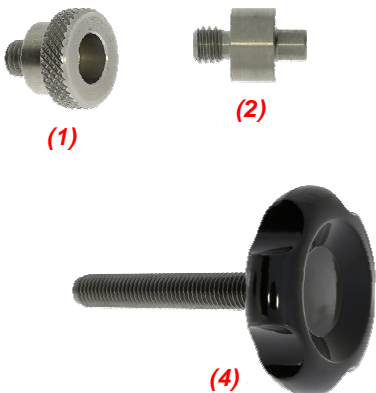

We recommend using only HOROTEC® original screw-on dies with our presses :

- They are made of Delrin (non-marring nylon)
- They are provided with a reinforced metal core, for extreme pressures
- There are many different models to cover all your needs
- They are adaptable on all presses on the market with a threaded axle Ø 6 mm.

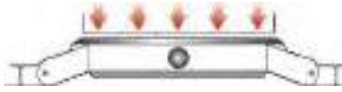

MSA	Packaging size	Kg
06.520	245 x 100 mm	0.144

Assortment of 8 Delrin® screw-on reversible dies FOR FITTING FLAT MINERAL CRYSTALS.



(1)

Universal inferior die



(2)

Die for crystals with loupe



(3)

Flat die

Assortment contents (brass centre thread Ø 6 mm) :

MSA	Item	Kg
06.520-16	Screw-on die, Ø 16 mm	0.004
06.520-2217	Screw-on die, Ø 17-22 mm	0.005
06.520-2823	Screw-on die, Ø 23-28 mm	0.008
06.520-3429	Screw-on die, Ø 29-34 mm	0.013
06.520-4035	Screw-on die, Ø 35-40 mm	0.019
06.520-4641	(3) Screw-on die, Ø 41-46 mm	0.025
06.520-A	(2) Screw-on die for crystals with loupe, Ø 35 mm	0.012
07.106-U	(1) Universal screw-on inferior die, Ø 45 mm	0.014

ASSORTMENT : SCREW-ON DIES

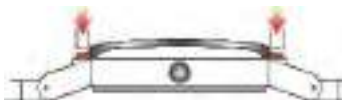

MSA	Packaging size	Kg
06.521	245 x 100 mm	0.164

Assortment of 11 Delrin® screw-on reversible dies FOR FITTING WATCH CRYSTALS.



(1)

Universal inferior die



(2)

Hollow die with thin straight edge. Depth 4.50 mm

Assortment contents (brass centre thread Ø 6 mm) :

MSA	Item	Kg
06.521-2526	Screw-on die, Ø 25-26 mm	0.007
06.521-2728	Screw-on die, Ø 27-28 mm	0.008
06.521-2930	Screw-on die, Ø 29-30 mm	0.009
06.521-3132	Screw-on die, Ø 31-32 mm	0.010
06.521-3333	Screw-on die, Ø 33-33.50 mm	0.011
06.521-3434	Screw-on die, Ø 34-34.50 mm	0.011
06.521-3535	Screw-on die, Ø 35-35.50 mm	0.012
06.521-3636	Screw-on die, Ø 36-36.50 mm	0.013
06.521-3737	Screw-on die, Ø 37-37.50 mm	0.013
06.521-3838	(2) Screw-on die, Ø 38-38.50 mm	0.014
07.106-U	(1) Universal screw-on inferior die, Ø 45 mm	0.014

ASSORTMENT : SCREW-ON DIES

ASSORTMENTS OF SCREW-ON DIES

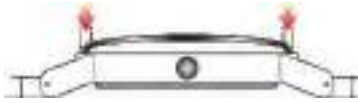

MSA	Packaging size	Kg
06.522	245 x 100 mm	0.163

Assortment of 15 Delrin® screw-on reversible dies FOR FITTING CRYSTALS WITH TENSION RING.

Assortment contents (brass centre thread Ø 6 mm) :

MSA	Item	Kg
06.522-15	Screw-on die, Ø 15 mm	0.003
06.522-1617	Screw-on die, Ø 16-17 mm	0.003
06.522-1819	Screw-on die, Ø 18-19 mm	0.004
06.522-2021	Screw-on die, Ø 20-21 mm	0.005
06.522-2223	Screw-on die, Ø 22-23 mm	0.005
06.522-2425	Screw-on die, Ø 24-25 mm	0.006
06.522-2627	Screw-on die, Ø 26-27 mm	0.007
06.522-2829	Screw-on die, Ø 28-29 mm	0.008
06.522-3031	Screw-on die, Ø 30-31 mm	0.009
06.522-3233	Screw-on die, Ø 32-33 mm	0.009
06.522-3435	Screw-on die, Ø 34-35 mm	0.010
06.522-3637	Screw-on die, Ø 36-37 mm	0.012
06.522-3839	Screw-on die, Ø 38-39 mm	0.013
06.522-4041	(2) Screw-on die, Ø 40-41 mm	0.014
07.106-U	(1) Universal screw-on inferior die, Ø 45 mm	0.014



Universal inferior die



Hollow die with oblique edge

ASSORTMENT SCREW-ON DIES



MSA	Packaging size	Kg
06.523	245 x 100 mm	0.156

Assortment of 5 Delrin® screw-on reversible dies FOR FITTING LARGE TENSION RING GLASSES.

Assortment contents (brass centre thread Ø 6 mm) :

MSA	Item	Kg
06.522-4245	Screw-on die, Ø 42-45 mm	0.015
06.522-4750	Screw-on die, Ø 47-50 mm	0.020
06.522-5255	Screw-on die, Ø 52-55 mm	0.023
06.522-5760	Screw-on die, Ø 57-60 mm	0.027
06.522-6265	(1) Screw-on die, Ø 62-65 mm	0.032



Curved die with thin edge

ASSORTMENT SCREW-ON DIES SPECIAL LARGE DIAMETER



Flat die

MSA	Packaging size	Kg
06.524	245 x 100 mm	0.208

Assortment of 4 Delrin® screw-on reversible dies FOR FITTING LARGE FLAT MINERAL GLASSES.

Assortment contents (brass centre thread Ø 6 mm) :

MSA	Item	Kg
06.520-4750	Screw-on die, Ø 47-50 mm	0.031
06.520-5255	Screw-on die, Ø 52-55 mm	0.039
06.520-5760	Screw-on die, Ø 57-60 mm	0.046
06.520-6265	(1) Screw-on die, Ø 62-65 mm	0.054

**ASSORTMENT
SCREW-ON DIES SPECIAL LARGE DIAMETER**

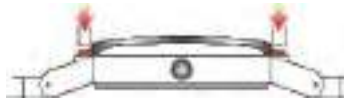

Reversible die

MSA	Packaging size	Kg
06.525	245 x 100 mm	0.163

Assortment of 5 Delrin® screw-on reversible dies FOR FITTING LARGE CASE BEZELS.

Assortment contents (brass centre thread Ø 6 mm) :

MSA	Item	Kg
06.521-4045	Screw-on die, Ø 40-45 mm	0.016
06.521-4650	Screw-on die, Ø 46-50 mm	0.020
06.521-5255	Screw-on die, Ø 52-55 mm	0.025
06.521-5760	Screw-on die, Ø 57-60 mm	0.029
06.521-6265	(1) Screw-on die, Ø 62-65 mm	0.033

**ASSORTMENT
SCREW-ON DIES SPECIAL LARGE DIAMETER**

ASSORTMENTS OF SCREW-ON DIES

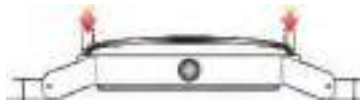

(1)

Depth 14 mm,
angle of attack 45°

MSA	Packaging size	Kg
06.526	245 x 100 mm	0.320

Assortment of 12 Delrin® screw-on reversible dies FOR FITTING VERY DOMED CRYSTALS.

Assortment contents (brass centre thread Ø 6 mm) :

MSA	Item	Kg
06.526-18	Screw-on die, Ø 18 mm	0.005
06.526-20	Screw-on die, Ø 20 mm	0.005
06.526-24	Screw-on die, Ø 24 mm	0.010
06.526-28	Screw-on die, Ø 28 mm	0.011
06.526-30	Screw-on die, Ø 30 mm	0.012
06.526-35	Screw-on die, Ø 35 mm	0.017
06.526-40	Screw-on die, Ø 40 mm	0.021
06.526-45	Screw-on die, Ø 45 mm	0.025
06.526-50	Screw-on die, Ø 50 mm	0.030
06.526-55	Screw-on die, Ø 55 mm	0.034
06.526-60	Screw-on die, Ø 60 mm	0.040
06.526-65	(1) Screw-on die, Ø 65 mm	0.045

ASSORTMENT SCREW-ON DIES SPECIAL LARGE DEPTH



(1)

Universal inferior die



(2)

Curved die with
straight and thick edge

MSA	Packaging size	Kg
07.106	245 x 100 mm	0.136

Assortment of 9 Delrin® screw-on reversible dies FOR FITTING SNAP-ON CASE BACKS.

Assortment contents (brass centre thread Ø 6 mm) :

MSA	Item	Kg
07.106-17	Screw-on die, Ø 17 mm	0.004
07.106-1921	Screw-on die, Ø 19-21 mm	0.005
07.106-2225	Screw-on die, Ø 22-25 mm	0.006
07.106-2629	Screw-on die, Ø 26-29 mm	0.008
07.106-3033	Screw-on die, Ø 30-33 mm	0.010
07.106-3437	Screw-on die, Ø 34-37 mm	0.012
07.106-3841	Screw-on die, Ø 38-41 mm	0.015
07.106-4245	(2) Screw-on die, Ø 42-45 mm	0.017
07.106-U	(1) Universal screw-on inferior die, Ø 45 mm	0.014

ASSORTMENT SCREW-ON DIES



**ASSORTMENT
SCREW-ON DIES**

MSA	Packaging size	Kg
07.107	245 x 100 mm	0.154

Assortment of 5 Delrin® screw-on reversible dies "Special Large Diameter". This assortment contains several types of dies for large watches.

Contents :

- 2 dies Ø 40-45 and 46-50 mm for fitting bezels
- 1 die Ø 47-50 mm for fitting flat mineral crystals
- 2 dies Ø 46-48 et 49-50 mm for fitting snap-on case backs.

Assortment contents (brass centre thread Ø 6 mm) :

MSA	Item	Kg
07.106-4648	Screw-on die, Ø 46-48 mm	0.020
06.520-4750 (1)	Screw-on die, Ø 47-50 mm	0.031
06.521-4045	Screw-on die, Ø 40-45 mm	0.016
06.521-4650	Screw-on die, Ø 46-50 mm	0.020
07.106-4950	Screw-on die, Ø 49-50 mm	0.022



**ASSORTMENT
SCREW-ON DIES SPECIAL LARGE DIAMETER**

MSA	Packaging size	Kg
07.108	245 x 100 mm	0.170

Assortment of 5 Delrin® screw-on reversible dies FOR FITTING SNAP-ON CASE BACKS.

Assortment contents (brass centre thread Ø 6 mm) :

MSA	Item	Kg
07.106-4648 (1)	Screw-on die, Ø 46-48 mm	0.020
07.106-4950	Screw-on die, Ø 49-50 mm	0.022
07.106-5255	Screw-on die, Ø 52-55 mm	0.025
07.106-5760	Screw-on die, Ø 57-60 mm	0.029
07.106-6265	Screw-on die, Ø 62-65 mm	0.034

ASSORTMENTS OF SCREW-ON DIES



ASSORTMENT

MSA	Packaging size	Kg
06.530	155 x 135 x 35 mm	0.160

Assortment of 6 Delrin® screw-on rectangular dies for fitting snap-on case backs brass or rectangular crystals.

Brass centre thread Ø 6 mm.

Assortment contents (brass centre thread Ø 6 mm) :

MSA	Item	Kg
06.530-24	(1) Die, length ext. x int. 24 x 13 mm, width 13 mm, height 13 mm	0.005
06.530-29	Die, length ext. x int. 29 x 18 mm, width 16 mm, height 13 mm	0.006
06.530-34	Die, length ext. x int. 34 x 23 mm, width 19 mm, height 13 mm	0.008
06.530-39	Die, length ext. x int. 39 x 28 mm, width 22 mm, height 13 mm	0.010
06.530-44	Die, length ext. x int. 44 x 33 mm, width 25 mm, height 13 mm	0.012
06.530-49	Die, length ext. x int. 49 x 38 mm, width 28 mm, height 13 mm	0.015



(1)

(2)

SCREW-ON DIES

MSA	For watches	Size	Depth	Kg
06.511-A	(1) Gent / Medium	45 x 37 mm	11 mm	0.024
06.511-B	(2) Lady	37 x 30 mm	9 mm	0.018

Screw-on Delrin® inferior die for watches with pyramidal crystal CHRONO. The die is placed on the base of the press and the watch comes above upside down to close snap-on case back without damaging the pyramidal crystal.

Compatible with all previous illustrated presses as well as the presses MSA07.367, MSA07.368 and MSA07.369.

Brass centre thread Ø 6 mm.



(1)

(2)

MSA	Items	Kg
07.373-A	(1) Upper adaptor Ø 16 mm	0.016
07.373-B	(2) Lower adaptor Ø 40 mm	0.089

Adaptor for presses MSA07.367, MSA07.368 and MSA07.369.

Use with all screw-on dies (thread 6 mm) of illustrated assortments above and on previous pages.

Assortments of Delrin® SNAP-ON dies. Compatible with presses MSA06.125, MSA06.130, MSA07.110, MSA07.150, MSA07.151 and MSA07.152.

Threading of snap-on dies is as follows :

- Ø 8 mm for superior dies
- Ø 5 mm for inferior dies.



ASSORTMENT

MSA	Packaging size	Kg
06.505	245 x 105 mm	0.155

Assortment of 12 Delrin® snap-on reversible dies FOR FITTING BEZELS.

Assortment contents :

MSA	Item	Kg
06.505-A12	Superior die, Ø 22.5 - 23.0 mm	0.004
06.505-A11	Superior die, Ø 24.0 - 25.0 mm	0.005
06.505-A10	Superior die, Ø 26.0 - 27.0 mm	0.006
06.505-A09	Superior die, Ø 28.0 - 29.0 mm	0.007
06.505-A08	Superior die, Ø 30.0 - 31.0 mm	0.007
06.505-A07	Superior die, Ø 32.0 - 32.5 mm	0.008
06.505-A06	Superior die, Ø 33.0 - 33.5 mm	0.009
06.505-A05	Superior die, Ø 34.0 - 34.5 mm	0.009
06.505-A04	Superior die, Ø 35.0 - 35.5 mm	0.011
06.505-A03	Superior die, Ø 36.0 - 36.5 mm	0.011
06.505-A02	Superior die, Ø 37.0 - 37.5 mm	0.011
06.505-A01	Superior die, Ø 38.0 - 38.5 mm	0.011



ASSORTMENT

MSA	Packaging size	Contents	Kg
07.112	120 x 106 mm	6 dies *	0.085
06.510	195 x 102 mm	10 dies	0.135

Assortment of Delrin® snap-on reversible dies FOR FITTING FLAT MINERAL CRYSTALS.

Assortments contents :

MSA	Item	Kg
06.510-A05	* Superior die, Ø 15.0 - 20.0 mm	0.003
06.510-A04	Superior die, Ø 17.5 - 22.5 mm	0.004
06.510-A03	* Superior die, Ø 25.0 - 30.0 mm	0.009
06.510-A02	Superior die, Ø 27.5 - 32.5 mm	0.011
06.510-A01	* Superior die, Ø 35.0 - 40.0 mm	0.017
-		-
06.510-B05	* Inferior die, Ø 15.0 - 20.0 mm	0.003
06.510-B04	Inferior die, Ø 17.5 - 22.5 mm	0.005
06.510-B03	* Inferior die, Ø 25.0 - 30.0 mm	0.009
06.510-B02	Inferior die, Ø 27.5 - 32.5 mm	0.011
06.510-B01	* Inferior die, Ø 35.0 - 40.0 mm	0.018

ASSORTMENTS OF SNAP-ON DIES



ASSORTMENT

MSA	Packaging size	Contents	Kg
07.111	195 x 102 mm	6 dies *	0.100
07.113	120 x 106 mm	6 dies **	0.085
07.116	195 x 102 mm	13 dies ***	0.155

Assortment of Delrin® reversible snap-on dies FOR FITTING SNAP-ON CASE BACKS.

Assortments contents :

MSA	Item	Kg
07.111-A03	*/*** Superior die, Ø 20 - 23 mm	0.004
07.111-A02	*/*** Superior die, Ø 26 - 29 mm	0.007
07.111-A01	*/*** Superior die, Ø 32 - 35 mm	0.010
07.111-A08	*** Superior die, Ø 36 - 38 mm	0.012
07.111-A07	*** Superior die, Ø 39 - 41 mm	0.014
07.111-A06	*** Superior die, Ø 42 - 44 mm	0.016
07.111-A05	*** Superior die, Ø 45 - 47 mm	0.018
07.111-A04	*** Superior die, Ø 48 - 50 mm	0.020
07.111-A09	** Superior die, Ø 52 - 55 mm	0.024
07.111-A10	** Superior die, Ø 57 - 60 mm	0.029
07.111-A11	** Superior die, Ø 62 - 65 mm	0.033
-	-	-
07.111-B03	*/*** Inferior die, Ø 29 mm	0.009
07.111-B02	*/*** Inferior die, Ø 35 mm	0.012
07.111-B06	*/*** Inferior die, Ø 40 mm	0.014
07.111-B05	*** Inferior die, Ø 45 mm	0.018
07.111-B04	*** Inferior die, Ø 50 mm	0.022
07.111-B07	** Inferior die, Ø 55 mm	0.026
07.111-B08	** Inferior die, Ø 60 mm	0.030
07.111-B09	** Inferior die, Ø 65 mm	0.035

Wheel press.



MSA	Size	Kg
07.050	200 x 200 x 425 mm	7.680

The strongest wheel press arm in its class.
 Ideal for opening and closing the most recalcitrant screw-on backs.
 Its extreme robustness and long stroke make it a perfect adaptable tool.
 The monobloc design of this press guarantees optimal alignment.
 The ergonomic wheel provides great working strength and is suitable for both right- and left-handed users.

Compatible with all HOROTEC® dies and case holders, see pages 07-25...07-28 and 07-30...07-32.

Professional rack-press equipped with 1 case holder and suction dies, for opening and closing watches with screw-on back cases. Thanks to this combined system, there is no contact between the metallic parts and the watch, thus eliminating any risk of scratching.

The case holder is made of a high adherence red synthetic deformable material ; inverted cone shape allows firmly holding in place all types of watches ; neither the crowns nor the pushers don't undergo any pressure. Holding watches with domes glass is not a problem anymore. The suction dies, delivered in different diameters and made of the same red synthetic deformable material, allow to operate on all different types of case backs even the most delicately worked (satin-like, transparent, etc.). The highly adherence material is easily distorted and adapts easily to the case back shape. In order to maintain good adherence of the suction dies, they must be cleaned regularly ; eliminate previous traces of arease or dust on the glass, the case and the case back before proceeding.



MSA07.368

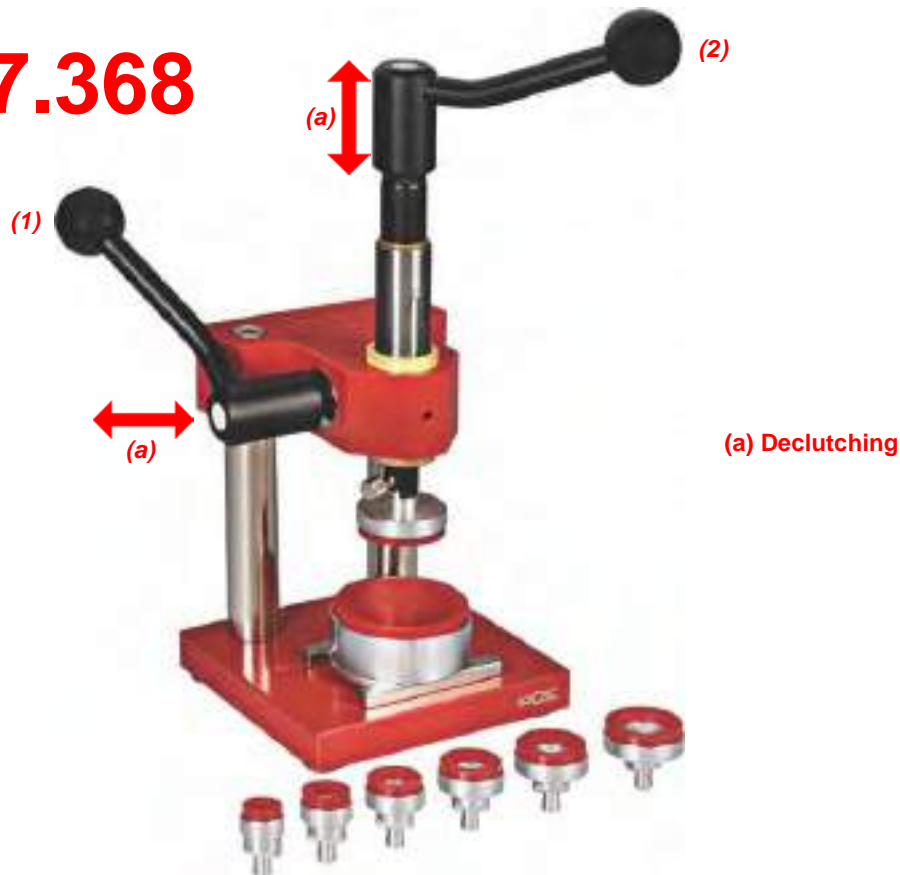

MSA	Size	Kg
07.368	180 x 130 x 350 mm	4.400

Professional rack-press, version with red suction dies.

The press is equipped with two handles that can be declutched to facilitate their positioning according to the desired angle :
 (1) Lateral handle allows to lower or to lift the toothed rack in order to have a better control of the pressure applied to the case back during unscrewing/screwing ;
 (2) Upper handle (mobile) is used to unscrew/screw the case back.

Compatible with all HOROTEC® dies and case holders, see pages 07-25...07-28 and 07-30...07-32.

Contents :

MSA	Item	Kg
07.333	Assortment of 7 red suction dies	0.140
07.367-A	Red suction case holder	0.130
07.367-P	Rack-press	4.000

Spare part :

MSA	Item	Kg
07.367-R	Lateral spring for press, Ø 18 x H 13 mm	0.005

Professional rack-press, full version.



MSA07.369



MSA	Size	Kg
07.369	180 x 130 x 350 mm	6.750

Rack-press delivered as a full version, for traditional work or only with the suction dies. Equipped with 2 adapters allowing use of all the dies with thread Ø 6 mm from the following assortments: MSA06.520, MSA06.521, MSA06.522, MSA07.106 and MSA07.107.

Compatible with all HOROTEC® dies and case holders, see pages 07-25...07-28 and 07-30...07-32.

Contents :

MSA	Item	Kg
07.367-P	Rack-press	4.000
07.367-A	(1) Red suction case holder	0.130
07.344	(2) Adjustable jaws holder, maximum opening 65 mm	0.225
07.323-A	(3) 2x round jaws	0.003
07.323-B	(3) 2x flat jaws	0.003
07.323-C	(3) 2x square jaws	0.003
07.323-D	(3) 2x knurled jaws	0.003
07.323-E	(3) 2x elongated jaws, reinforced square	0.004
07.323-F	(3) 2x elongated jaws, reinforced round	0.004
07.371	(4) Lower tray	0.220
07.372	(5) 2x upper tray	0.325
07.373-A	(6) Upper adaptor Ø 16 mm (see page 07-14)	0.016
07.373-B	(7) Lower adaptor Ø 40 mm (see page 07-14)	0.089
07.374	(8) Case holder with 4 stacked jaws, height 29 mm	0.160
07.333	(9) Assortment of 7 red suction dies	0.140
07.311	(10) Assortment of 8 steel dies	0.510
07.327	(11) Assortment of 3 steel dies BM type	0.220
07.336	(12) Assortment of 4 steel dies SEAM. type	0.582
10.524	Pin punch support, Ø 8 x L35 mm	0.012

Spare part :

MSA	Item	Kg
07.367-R	Lateral spring for press, Ø 18 x H 13 mm	0.005

Professional rack-press, light version.



MSA07.367

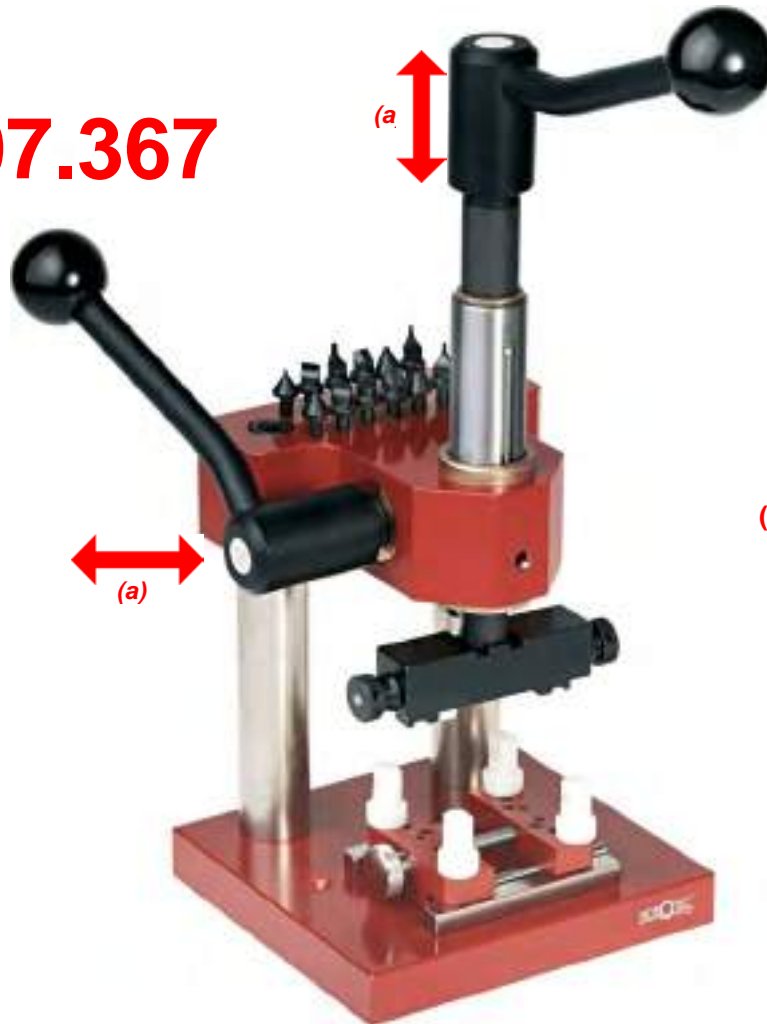

(a) Declutching

MSA	Size	Kg
07.367	180 x 130 x 350 mm	4.500

Rack-press delivered in the light version, to work in a traditional way.

Compatible with all HOROTEC® dies and case holders, see pages 07-25...07-28 and 07-30...07-32.

Contents :

MSA	Item	Kg
07.323-E	2x elongated jaws, reinforced square	0.004
07.323-F	2x elongated jaws, reinforced round	0.004
07.374	Case holder with 4 stacked jaws, height 29 mm	0.160
07.323-A	2x round jaws	0.003
07.323-B	2x flat jaws	0.003
07.323-C	2x square jaws	0.003
07.323-D	2x knurled jaws	0.003
07.344	Adjustable jaws holder, maximum opening 65 mm	0.225
07.367-P	Rack-press	4.000

Spare part :

MSA	Item	Kg
07.367-R	Lateral spring for press, Ø 18 x H 13 mm	0.005

Complete version of the professional precision HOROTEC® press, heavy and robust for opening/closing screw-on case backs of all types of watches.

- The professional precision HOROTEC® press is deliverable in 4 different versions
- The references of the 4 pairs of jaws MSA07.323-x delivered with the illustrated presses here below are the following : MSA07.323-A, -B, -C and -D
- The jaws MSA07.323-E and -F are also compatible and available separately.



Dies can be used upside down.



Case lugs jaws can be used. (See page 07-28)

MSA	Size	Kg
07.363	160 x 220 x 280 mm	5.035

Features :

- Large ergonomic top wheel Ø 160 mm for screwing/unscrewing with no effort
- Centre threaded broach with precise blocking ring
- Solid steel supporting pillars covered with anti-skid and ergonomic synthetic material, for right and left handed
- Base has a removable die tray for easy selection and storage
- Removable watch holder with 12 holes for concave Delrin® dies and 4 holes for case lugs dies
- Base equipped with 4 anti-skid feet.

Compatible with all HOROTEC® dies and case holders, see pages 07-25...07-28 and 07-30...07-32.

Contents :

MSA	Item	Kg
07.311	Assortment of 8 steel dies	0.510
07.323-A	2x round jaws	0.003
07.323-B	2x flat jaws	0.003
07.323-C	2x square jaws	0.003
07.323-D	2x knurled jaws	0.003
07.325	Assortment of 7 blue suction dies	0.320
07.327	Assortment of 3 steel dies BM type	0.220
07.344	Adjustable jaws holder, maximum opening 65 mm	0.225
07.360-A	Adjustable case holder with 4 Delrin® dies	0.110
07.375	Removable dies holder tray	0.385

Other variants of the complete version MSA07.363.



MSA	Size	Kg
07.360	160 x 220 x 280 mm	4.700

Press delivered with :

- 1 adjustable case holder MSA07.360-A
- 1 adjustable jaws holder MSA07.344
- 4 pairs of jaws MSA07.323-x.

Compatible with all HOROTEC® dies and case holders, see pages 07-25...07-28 and 07-30...07-32.



MSA	Size	Kg
07.361	160 x 220 x 280 mm	4.145

Press delivered with :

- 1 adjustable case holder MSA07.360-A
- 1 adjustable jaws holder MSA07.344
- 4 pairs of jaws MSA07.323-x
- 7 suction dies MSA07.325-x.

Compatible with all HOROTEC® dies and case holders, see pages 07-25...07-28 and 07-30...07-32.



MSA	Size	Kg
07.364	160 x 220 x 280 mm	4.155

Press delivered with :

- 1 adjustable case holder MSA07.360-A
- 1 adjustable jaws holder MSA07.344
- 4 pairs of jaws MSA07.323-x
- 1 assortment of 8 steel dies MSA07.311.

Compatible with all HOROTEC® dies and case holders, see pages 07-25...07-28 and 07-30...07-32.



MSA	Size	Kg
07.365	160 x 220 x 280 mm	4.030

Press delivered with :

- 1 adjustable case holder MSA07.360-A
- 1 adjustable jaws holder MSA07.344
- 4 pairs of jaws MSA07.323-x
- 1 assortment of 3 steel dies BM type MSA07.327.

Compatible with all HOROTEC® dies and case holders, see pages 07-25...07-28 and 07-30...07-32.

Accessories.



MSA	Size	Kg
07.370	160 x 55 x 53 mm	0.345

Removable dies holder tray for presses MSA07.360, MSA07.361, MSA07.363, MSA07.364 and MSA07.365.



MSA	Size	Kg
07.375	160 x 72 x 53 mm	0.385

Removable dies holder tray for presses MSA07.360, MSA07.361, MSA07.363, MSA07.364 and MSA07.365.



MSA	Size	Kg
07.372	160 x 55 x 46 mm	0.325

Upper dies holder tray, accessory for presses MSA07.367, MSA07.368 and MSA07.369.
Can be stacked on lower tray MSA07.371.



MSA	Size	Kg
07.371	160 x 55 x 10 mm	0.220

Lower dies holder tray, accessory for presses MSA07.367, MSA07.368 and MSA07.369.
Used as base support for various upper trays MSA07.372.



MSA	Kg
07.360-H	0.125

Adapter for OM broach. Fits on presses MSA07.360, MSA07.361, MSA07.363, MSA07.364 and MSA07.365.

Mini HOROTEC® professional precision press.



MSA	Size	Kg
07.320	110 x 95 x 200 mm	1.900

Mini professional precision press. Small and robust, built in steel and aluminium. Equipped with removable and adjustable watch holder with 4 Delrin® dies to hold the watch cases surely and horizontally. First fit the case in the watch holder and then unscrew the case back with the adjustable jaws holder. Excellent frontal, lateral or plunging view. Top wheel Ø 75 mm.

Several accessories are available as an option. Compatible with all HOROTEC® dies and case holders, see pages 07-25...07-28 and 07-30...07-32.

Contents :

MSA	Item	Kg
07.320-A	Gasket for broach	0.001
07.323-A	2x round jaws	0.003
07.323-B	2x flat jaws	0.003
07.323-C	2x square jaws	0.003
07.323-D	2x knurled jaws	0.003
07.344	Adjustable jaws holder, maximum opening 65 mm	0.225
07.360-A	Adjustable case holder with 4 Delrin® dies	0.110

Assortment of suction dies with increased adherence for opening/closing screw-on case backs, in red synthetic material (more flexible than the blue suction dies MSA07.325) drowned in aluminium.

Slightly deformable material that adapts to the case back shape. For optimal adherence, remove all traces of grease or dust on the synthetic material and the case back, using a cloth soaked with alcohol or benzene.

Compatible with all presses MSA07.050, MSA07.170, MSA07.320 and MSA 07.36x.



ASSORTMENT

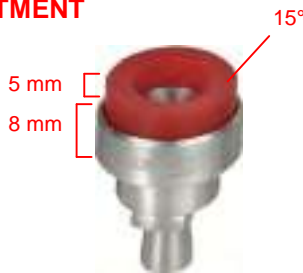

MSA	Contents	Ø	Kg
07.343	10 dies	16...55 mm	0.180

Assortment of 10 red suction dies.
Delivered in a cardboard box.

Detail of dies :

MSA	Item	Kg
07.333-016	Suction die Ø 16 mm	0.011
07.333-020	Suction die Ø 20 mm	0.013
07.333-023	Suction die Ø 23 mm	0.016
07.333-026	Suction die Ø 26 mm	0.018
07.333-030	Suction die Ø 30 mm	0.022
07.333-034	Suction die Ø 34 mm	0.026
07.333-040	Suction die Ø 40 mm	0.032
07.333-045	Suction die Ø 45 mm	0.040
07.333-050	Suction die Ø 50 mm	0.045
07.333-055	Suction die Ø 55 mm	0.050



ASSORTMENT

MSA	Contents	Ø	Kg
07.333	7 dies	16...40 mm	0.140

Assortment of 7 red suction dies.
Delivered in a cardboard box.

Detail of dies :

MSA	Item	Kg
07.333-016	Suction die Ø 16 mm	0.011
07.333-020	Suction die Ø 20 mm	0.013
07.333-023	Suction die Ø 23 mm	0.016
07.333-026	Suction die Ø 26 mm	0.018
07.333-030	Suction die Ø 30 mm	0.022
07.333-034	Suction die Ø 34 mm	0.026
07.333-040	Suction die Ø 40 mm	0.032



ASSORTMENT

MSA	Contents	Ø	Kg
07.339	3 dies	45...55 mm	0.178

Assortment of 3 red suction dies.
Delivered in a cardboard box.

Detail of dies :

MSA	Item	Kg
07.333-045	Suction die Ø 45 mm	0.040
07.333-050	Suction die Ø 50 mm	0.045
07.333-055	Suction die Ø 55 mm	0.050

PRESSES FOR SCREW / UNSCREW CASE BACKS

HOROTEC



ASSORTMENT



MSA	Contents	Ø	Kg
07.325	7 dies *	16...40 mm	0.178

Assortment of 7 suction dies for opening/closing screw-on case backs. Made of non-deformable blue synthetic material, drowned in aluminium for a perfect adherence and durable use. Adaptable on presses MSA07.050, MSA07.170, MSA07.320 and MSA07.36x.

Delivered in a cardboard box.

Detail of dies :

MSA	Item	Kg
07.325-016	* Suction die Ø 16 mm	0.012
07.325-020	* Suction die Ø 20 mm	0.014
07.325-023	* Suction die Ø 23 mm	0.016
07.325-026	* Suction die Ø 26 mm	0.019
07.325-030	* Suction die Ø 30 mm	0.023
07.325-034	* Suction die Ø 34 mm	0.027
07.325-040	* Suction die Ø 40 mm	0.034
07.325-045	Suction die Ø 45 mm	0.040

Jaws holder and jaws.

HOROTEC



← 65 mm →

Ø 8 mm

MSA	Maximun opening	Kg
07.344	65 mm	0.225

Adjustable jaws holder for professional precision presses MSA07.050, MSA07.320 and MSA07.36x. Compatible with all jaws MSA07.323-x.

HOROTEC

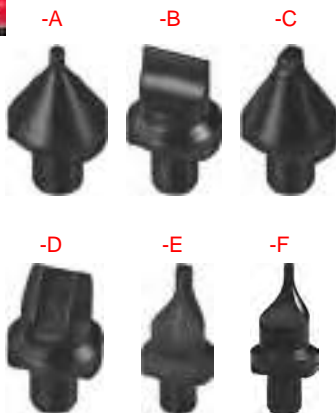

Ø 5 mm

MSA	Jaws shape	Kg
07.323-A	Round	0.003
07.323-B	Flat	0.003
07.323-C	Square	0.003
07.323-D	Knurled	0.003
07.323-E	Square, elongated	0.004
07.323-F	Round, elongated	0.004

Jaws for screw-on case backs, accessories for jaws holder MSA07.344 of presses MSA07.050, MSA07.320 and MSA07.36x.

Case holders.



← 70 mm →

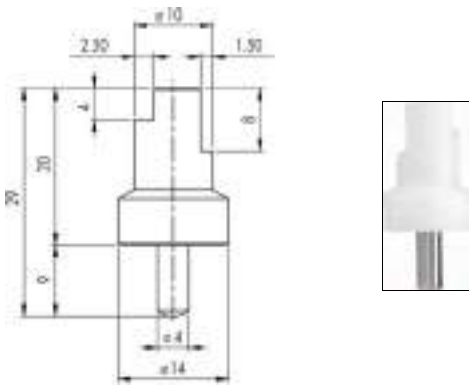

MSA	Maximun opening	Kg
07.374	70 mm	0.160

Adjustable aluminium case holder for all HOROTEC® presses. The stacked dies are fitted in reinforced pierced holes with a steel cylinder. They are particularly recommended for heavy-duty work. Delivered with 4 Delrin® dies MSA07.374-A.

Spare part :

MSA	Item	Kg
07.374-A	Stacked Delrin® die	0.005



← 70 mm →

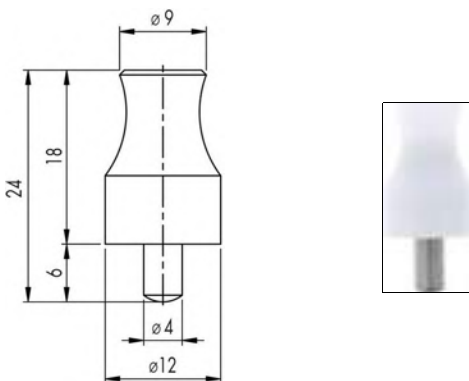

MSA	Maximun opening	Kg
07.360-A	70 mm	0.110

Adjustable aluminium case holder for all HOROTEC® presses. Delivered with 4 Delrin® dies MSA07.360-B.

Spare part :

MSA	Item	Kg
07.360-B	Delrin® die	0.015



∅ 4 mm

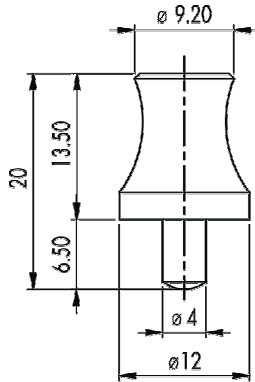

MSA

Kg

07.322

0.002

Concave Delrin® die, accessory for case holders MSA07.360-A and MSA07.374.



← 70 mm →

MSA

Kg

07.367-A

0.130

Case holder with red suction cup.

- ∅ external aluminium : 66 mm
- External ∅ of the suction cup : 64 mm
- Suction cup depth : 25 mm.

For presses MSA07.050, MSA07.060, MSA07.170, MSA07.360, MSA07.361, MSA07.363, MSA07.364, MSA07.365, MSA07.367, MSA07.368 and MSA07.369.

HOROTEC® case openers. Simple and very efficient for opening watch screw-on case backs with integrated bracelets (also for ladies watches where work space is very narrow). For watches with large dimensions due to the opening up to 65 mm.



← 65 mm →



MSA	Length	Maximun opening	Kg
07.013	190 mm	65 mm	0.295

Case opener delivered with 1 pair of jaws MSA07.323-E.
Use with jaws MSA07.323-x as shown on page 07-26.



← 57 mm →



MSA	Length	Maximun opening	Kg
07.014	155 mm	57 mm	0.340

Case opener delivered with 1 pair of jaws MSA07.323-E.
Use with jaws MSA07.323-x as shown on page 07-26.

These dies are adaptable on all HOROTEC® presses for screw-on case backs.



MSA	Kg
07.312	0.645

Assortment of 8 steel dies MSA07.311 with handle for opening /closing screw-on case backs.

Spare parts :

MSA	Item	Kg
07.305	Handle	0.270
07.305-A	Screw for handle	0.008
07.311	Assortment of 8 steel dies	0.510

ASSORTMENT



MSA	Ø	Kg
07.311	18.5...36.5 mm	0.510

Assortment of 8 steel dies for opening/closing screw-on case backs.

Spare parts :

MSA	Item	Kg
07.326-185	Die Ø 18.5 mm	0.037
07.326-202	Die Ø 20.2 mm	0.043
07.326-225	Die Ø 22.5 mm	0.047
07.326-265	Die Ø 26.5 mm	0.056
07.326-283	Die Ø 28.3 mm	0.058
07.326-295	Die Ø 29.5 mm	0.064
07.326-340	Die Ø 34.0 mm	0.080
07.326-365	Die Ø 36.5 mm	0.090

ASSORTMENT



MSA	Kg
07.307	0.442

Assortment of 3 steel dies MSA07.327 with handle for opening /closing screw-on case backs BM type.

Spare parts :

MSA	Item	Kg
07.305	Handle	0.270
07.305-A	Screw for handle	0.008
07.327	Assortment of 3 steel dies BM type	0.220

ASSORTMENT



-033

-030

-025

ASSORTMENT

MSA	Ø	Kg
07.327	25...33 mm	0.220

Assortment of 3 steel dies for opening/closing screw-on case backs BM type.

Spare parts :

MSA	Item	Kg
07.327-025	Die Ø ext. 25 mm	0.047
07.327-030	Die Ø ext. 30 mm	0.059
07.327-033	Die Ø ext. 33 mm	0.067



ASSORTMENT

MSA	Kg
07.308	0.820

Assortment of 8 steel dies MSA07.311 and 3 steel dies MSA07.327 with handle for opening/closing screw-on case backs BM type.

Spare parts :

MSA	Item	Kg
07.305	Handle	0.270
07.305-A	Screw for handle	0.008
07.311	Assortment of 8 steel dies	0.510
07.327	Assortment of 3 steel dies BM type	0.220



ASSORTMENT

MSA	Kg
07.337	0.826

Assortment of 4 steel dies MSA07.336 with handle MSA07.305 for opening/closing screw-on case backs SEAM. type.

Spare parts :

MSA	Item	Kg
07.305	Handle	0.270
07.305-A	Screw for handle	0.008
07.336	Assortment of 4 dies SEAM. type	0.582

TOOLS FOR SCREW / UNSCREW CASE BACKS



-042 -033 -030 -020

ASSORTMENT

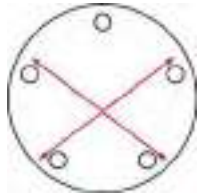

MSA	Ø	Kg
07.336	20...42 mm	0.582

Assortment of 4 steel dies for opening/closing screw-on case backs SEAM type.

Spare parts :

MSA	Item	Kg
07.330-020	Die SEAM. type, lady Ø 20 mm	0.095
07.330-030	Die SEAM. type, gent Ø 30 mm	0.095
07.330-033	Die SEAM. type, Ø 33 mm	0.140
07.330-042	Die SEAM. type, Ø 42 mm	0.141



-034 -035 -036A



-036 -037 -038

ASSORTMENT

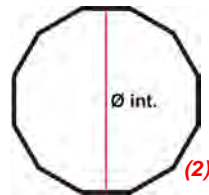
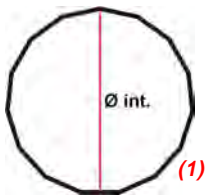

MSA	Ø	Kg
07.335	34...38 mm	0.260

Assortment of 6 steel dies for opening/closing screw-on case backs BR type.

Spare parts :

MSA	Items	Ø	Kg
07.335-034	(1) Die BR type with 15 sides	34.00 mm	0.037
07.335-035	(1) Die BR type with 15 sides	35.00 mm	0.038
07.335-036A	(2) Die BR type with 12 sides	36.00 mm	0.042
07.335-036	(1) Die BR type with 15 sides	36.00 mm	0.041
07.335-037	(1) Die BR type with 15 sides	37.00 mm	0.041
07.335-038	(1) Die BR type with 15 sides	38.00 mm	0.042



-030 -035 -039 -042

ASSORTMENT

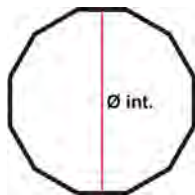

MSA	Ø	Kg
07.334	30.60...42.50 mm	0.532

Assortment of 4 steel dies for opening/closing screw-on case backs PAN type.

Spare parts :

MSA	Items	Ø	Kg
07.334-030	Die PAN type with 12 sides	30.60 mm	0.089
07.334-035	Die PAN type with 12 sides	35.55 mm	0.107
07.334-039	Die PAN type with 12 sides	39.00 mm	0.104
07.334-042	Die PAN type with 12 sides	42.50 mm	0.125



MSA	Ø	Kg
07.331	35 mm	0.070

Steel die for opening/closing screw-on case backs CT Aqualand type.

Other openers for screw-on case backs.



MSA	Size	Kg
07.210	70 x 37 mm	0.080

Case opener with 2 hardened steel jaws for opening/closing cases with screwed-on backs.



MSA	Size	Kg
07.208	70 x 37 mm	0.080

Case opener with 2 flat hardened steel jaws for opening/closing cases with screwed-on backs.



MSA	Size	Kg
07.209	70 x 37 mm	0.080

Case opener with 2 pointed hardened steel jaws for opening/closing cases with screwed-on backs.



MSA	Ø	Kg
07.022	± 65 mm	0.042

Friction ball with high adherence for opening/closing cases with screwed-on backs.

Case openers for snap-on case backs.



MSA	Length	Kg
07.004	122 mm	0.165

Automatic case opener for snap-on case backs. Handle inside equipped with a spring and firing pin, when turned on opens the case backs in one micro-choc. The strength of the choc is adjustable by screwing (+ power) or unscrewing (- power) the handle. *Delivered with 3 shaped blades.*

Spare parts :

MSA	Item	Kg	
07.004-01	Assortment of 3 blades	0.012	
07.004-A	Straight blade, width 5 mm	0.004	
07.004-B	Bended blade, width 3.5 mm	0.004	
07.004-C	Bended blade, width 4.5 mm	0.004	
07.004-D	O'Ring gasket	0.001	
07.004-E	Spring small model	0.002	
07.004-G	Blades holder	0.008	
07.004-H	Spring large model	0.003	
07.004-J	Hammer	0.005	



MSA	Type	Length	Kg
07.026	Right-handed user	137 mm	0.106

Case opener with knurled aluminium handle allowing an excellent grip for opening cases with snapped-on backs. Interchangeable stainless steel blade. *Delivered with an Allen key for blade changing.*

Spare parts :

MSA	Item	Kg	
07.026-B	Blade	0.004	
07.026-V	Screw	0.001	



MSA	Length	Kg
07.001	115 mm	0.028

Case opener with aluminium handle and one stainless steel fixed blade for opening cases with snapped-on backs.



MSA	Length	Kg
07.016	113 mm	0.018

Case opener with plastic handle and one stainless steel fixed blade without rivets for opening cases with snapped-on backs.



MSA	Length	Kg
07.007	135 mm	0.034

Lever case opener with robust handle for a better grip for opening cases with snapped-on backs.

SEIKO



MSA		Length	Kg
07.018		82 mm	0.024
07.019		86 mm	0.022
07.020		85 mm	0.021

Robust case opener with plastic handle and one stainless steel fixed blade for opening cases with snapped-on backs.



MSA	Packaging size	Kg
07.024	155 x 145 x 37 mm	0.230

Assortment of 4 case openers with plastic handle and one stainless steel blade for opening cases with snapped-on backs.

Spare parts :

MSA	Item	Kg	
07.024-A	Case opener, length 87 mm, blade width 10 mm	0.026	
07.024-B	Case opener, length 87 mm, blade width 4 mm	0.024	
07.024-C	Case opener, length 87 mm, blade width 10 mm	0.026	
07.024-D	Case opener, length 87 mm, blade width 4 mm	0.024	

ASSORTMENT



PRECIPEC



MSA	Length closed	Kg
07.025	83 mm	0.041

Robust case opener with white aluminium handle and 2 retract-able stainless steel blades for opening cases with snapped-on backs.



MSA	Colour	Length closed	Kg
07.006-01	Red	83 mm	0.036
07.006-02	Black	83 mm	0.036
07.006-03	Blue	83 mm	0.036
07.006-05	White	83 mm	0.036

Robust case opener with 2 retract-able stainless steel blades. Thick plastic handle for opening cases with snapped-on backs.

SEIKO



MSA	Size	Kg
07.009	100 x 160 x 100 mm	0.470

Adjustable case opener for all types of cases with snapped-on backs.
Delivered with users manual and spare blade.

Spare parts :

MSA	Item	Kg
07.009-01	(1) Pair of blades	0.004
07.009-02	(2) Pair of pins without protection	0.004

Tools for opening snap-on case backs and extracting snap-on bezels.

HOROTEC

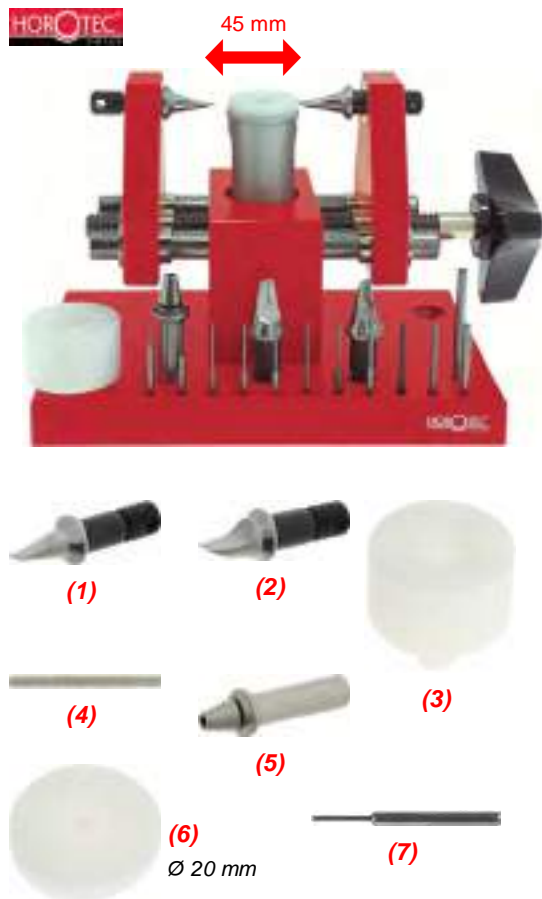

MSA	Size	Maximun opening	Kg
07.115	120 x 75 x 85 mm	45 mm	0.960

Tool for opening snap-on watch case backs and removing snap-on bezels. Allows a precise adjustment due to an anti-skid case holder mounted on a spring. The tool is equipped with precision sliding carriage for delicately extracting of glasses or recalcitrant case backs.
Delivered with 2 pairs of hardened steel polished blades, 1 bored case-supporting Delrin® die to avoid damaging crowns and pushers.

Spare parts :

MSA	Item	Kg
07.115-A	(1) Hardened steel blade, width 2 mm Hardness 54-56 HRC	0.009
07.115-B	(2) Hardened steel blade, width 4 mm Hardness 54-56 HRC	0.009
07.115-C	(3) Case-supporting die, hole Ø 10 mm	0.009
07.115-D	(4) Hardened steel stem, Ø 2.5 x length 40 mm	0.010
07.115-E	(5) Pin punch holder, length 36 mm	0.010
07.115-G	(6) Delrin® pad for central column, Ø 20 mm	0.002
10.503-A	(7) Assortment of 11 pin punches : MSA10.503-040, -060, -070, -080, -090, -100, -110, -120, -140, -150 and -200 (Ø 0.40...2.00 mm)	0.060

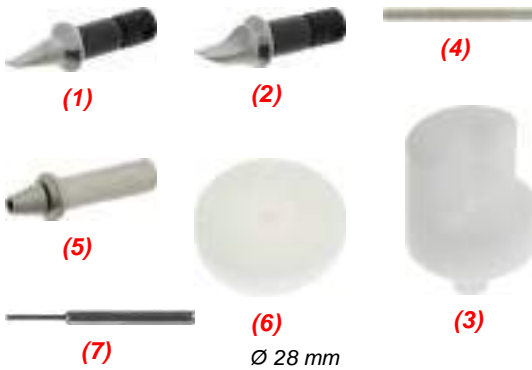
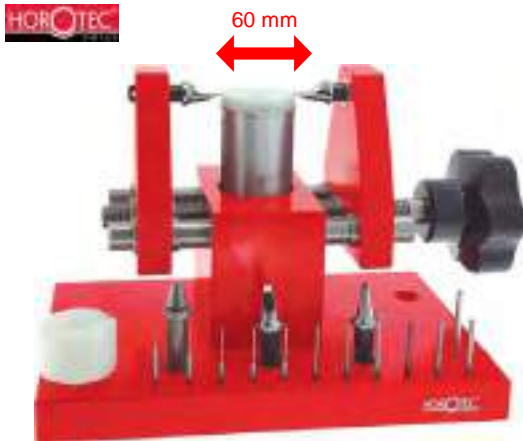

MSA	Size	Maximun opening	Kg
07.119	155 x 100 x 110 mm	60 mm	1.500

Same functions as the tool MSA07.115 tool but with a maximum opening of 60 mm instead of 45 mm for the MSA07.115. Equipped with a screw for stabilizing the table at the desired height.

Spare parts :

MSA	Item	Kg
07.115-A	(1) Hardened steel blade, width 2 mm Hardness 54-56 HRC	0.009
07.115-B	(2) Hardened steel blade, width 4 mm Hardness 54-56 HRC	0.009
07.115-D	(4) Hardened steel stem, Ø 2.5 x length 40 mm	0.010
07.115-E	(5) Pin punch holder, length 36 mm	0.010
07.119-C	(3) Case-supporting die, hole Ø 10 mm	0.009
07.119-G	(6) Delrin® pad for central column, Ø 28 mm	0.002
10.503-A	(7) Assortment of 11 pin punches : MSA10.503-040, -060, -070, -080, -090, -100, -110, -120, -140, -150 and -200 (Ø 0.40...2.00 mm)	0.060



← 40 mm →

PAIR

MSA	Maximun opening	Kg
07.115-F	40 mm	0.085

Pair of adaptors with 2 mirror polished blades adaptable to MSA07.115 and MSA07.119, allowing the extraction of bezels or opening recalcitrant case backs delicately.

Spare part :

MSA	Item	Kg
07.117-A	Blade (delivered individually)	0.006

Tools for removing bezels.



MSA	Size	Kg
07.117	150 x 60 x 65 mm	0.885

Tool for removing bezels up to Ø 60 mm.
 Provided with 4 interchangeable hardened mirror polished steel blades.

Spare part :

MSA	Item	Kg
07.117-A	Blade (delivered individually)	0.006



MSA	Kg
07.031	0.030

Rubber tool for extracting rotating bezels from Ø 38 to 45 mm.

Tools for Swatch® battery covers.



MSA	Length	For watch	Kg
07.010	120 mm	Gent	0.072
07.012	120 mm	Medium	0.072
07.011	120 mm	Lady	0.071

Tool for Swatch® battery covers.



MSA	For watch	Kg
03.620-GENT (1)	Gent	0.015
03.620-MED (2)	Medium	0.015
03.620-LADY (3)	Lady	0.015

Interchangeable key to fit in the handle MSA03.620-A.



MSA	Kg
03.620-A	0.060

Hexagonal handle on which all types of here above keys and those illustrated on chapter 03 can be fitted.



See chapter PERF.

08

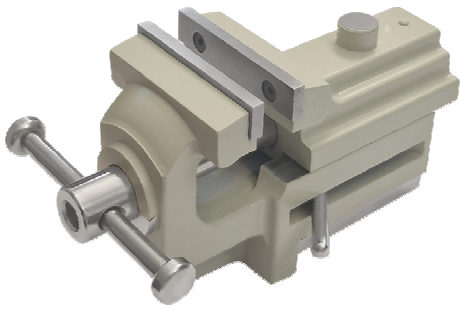

Case holders.



← 70 mm →

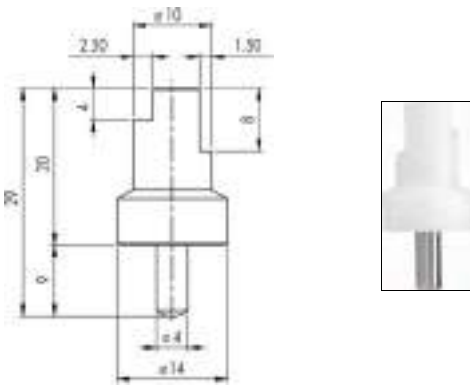

MSA	Maximal opening	Kg
07.374	70 mm	0.160

Adjustable aluminium case holder for all HOROTEC® presses.
The stacked dies are fitted in reinforced pierced holes with a steel cylinder.
They are particularly recommended for heavy-duty work.
Delivered with 4 Delrin® dies MSA07.374-A.

Spare part :

MSA	Item	Kg
07.374-A	Stacked Delrin® die	0.005



← 70 mm →

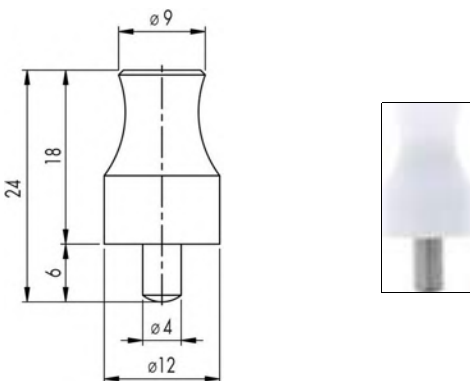

MSA	Maximal opening	Kg
07.360-A	70 mm	0.110

Adjustable aluminium case holder for all HOROTEC® presses.
Delivered with 4 Delrin® dies MSA07.360-B.

Spare part :

MSA	Item	Kg
07.360-B	Delrin® die	0.015

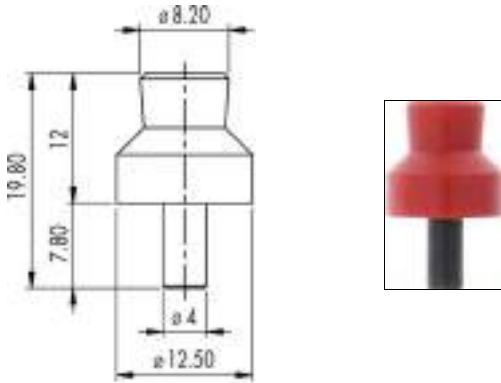

MSA	Size	Kg
08.001	65 x 45 mm	0.073

Universal synthetic material and metal case holder, with 4 Nylon® dies MSA08.001-A.

Spare part :

MSA	Item	Kg
08.001-A	Nylon® die	0.003



See chapter PERF.

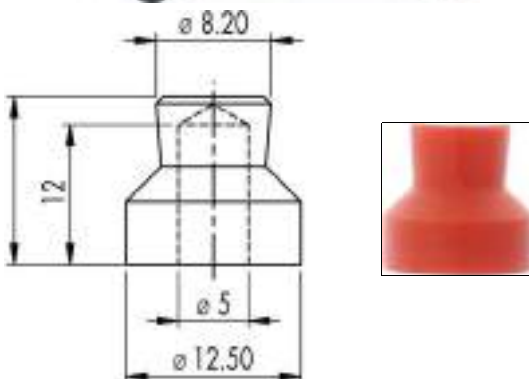

MSA	Size	Kg
08.002	83 x 65 mm	0.192

Metal case holder, with 4 Nylon® dies MSA08.002-A, driven on a 5 mm axle.

Spare part :

MSA	Item	Kg
08.002-A	Nylon® die	0.001



← 20...60 mm →

MSA	Size	Maximal opening	Kg
08.010	Ø 115 x 65 mm	20...60 mm	0.396

Universal synthetic material case holder, with 4 Delrin® dies and 1 washer MSA08.010-A.

Spare part :

MSA	Item	Kg
08.010-A	Delrin® die + 1 washer	0.012

Vices.

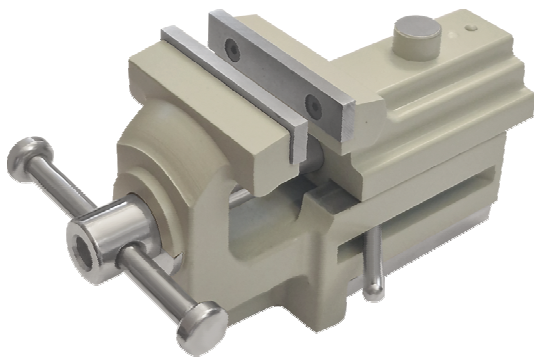

← 35 mm →

MSA	Size	Maximal opening	Kg
08.104	120 x 65 mm	35 mm	1.250

Vice with fixing brass plate. The plate remains fixed on the bench allowing the vice to be easily settled or removed thanks to the side lever. Jaws width 50 mm.

Spare parts :

MSA	Item	Kg
08.104-A	Fixing brass plate, 55 x 38 x 7 mm	0.098
08.104-B	Oak vice wood, 77 x 18 x 14 mm	0.014
08.104-C	Delrin cover for fixing plate	?



MSA	Size	Maximal opening	Kg
24.109	50 x 120 mm	50 mm	0.547

Black bench clamp for vice fixing. Compatible with vice MSA08.104. Delivered without fixing brass plate.



MSA	Size	Maximal opening	Kg
24.113	70 x 95 mm	60 mm	0.565

Grey bench clamp for vice fixing. Compatible with vice MSA08.104. Delivered without fixing brass plate.



MSA	Size	Kg
24.405	60 x 60 x 50 mm	0.150

Wooden vice base.
Easy mounting on a bench thanks to a screw fitted with a detachable handle.
Compatible with vice MSA08.104.
Delivered without fixing brass plate.

Accessory :

MSA	Item	Kg
24.405-01	Metal insert M6	0.008

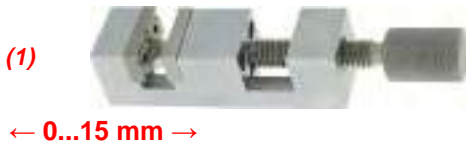

MSA	Size	Maximal opening	Kg
08.502	(1) 14 x 14 x 67 mm	0...15 mm	0.075

Mini hand vice. Hardened rectified steel jaws (1 of the jaws is equipped with maintaining grooves).
Jaws width 14 mm.

Accessory :

MSA	Item	Kg
08.503	(2) Revolving base Ø 50 x 37 mm	0.149



MSA	Size	Kg
10.519	50 x 45 x 40 mm	0.105

Bracelet holder vice with screw.
- Maximum bracelet thickness : 10 mm
- Useful dimensions : length 49 mm and height 24 mm
- Suitable for presses MSA10.499 and 10.500 illustrated on page 10-2.



MSA	Size	Kg
10.513	55 x 35 x 22 mm	0.050

Bracelet holder vice with screw.
- Maximum bracelet thickness : 9.50 mm
- Useful dimensions : length 35 mm and height 12 mm
- Suitable for presses MSA10.499 and 10.500 illustrated on page 10-2.

09



MOVEMENT HOLDERS

09 - 2

CASE CUSHIONS

09 - 12

RIVETING PLATE

09 - 14

MOVEMENT HOLDERS

Movement holder, nickel-plated brass, base Ø 31 mm. Equipped with adjustable screws to support pivots and endstones, with and without pushers for control.

Compatible with presses MSA05.050, MSA05.100, MSA05.101, MSA05.109, MSA05.110, MSA05.111, MSA05.112, MSA05.114, MSA05.115, MSA05.116, MSA05.117, MSA05.129 and MSA05.131.



MSA	Calibres ""	Screws	Kg
09.010-02	4 1/4""	1	0.029
09.010-03	4 1/2""	1	0.029
09.010-48	4 3/4""	1	0.030
09.010-50	4 7/8""	1	0.077
09.010-05	5 1/2""	1	0.033
09.010-06	6 3/4""	1	0.038
09.010-08	7 3/4""	1	0.042
09.010-09	8""	1	0.042
09.010-10	8 1/4""	1	0.043
09.010-11	8 3/4""	1	0.046
09.010-12	9""	1	0.047
09.010-13	9 1/4""	1	0.049
09.010-14	9 3/4""	1	0.051
09.010-15	10 1/2""	1	0.055
09.010-22	11""	1	0.058
09.010-16	11 1/2""	1	0.061
09.010-17	11 3/4""	1	0.063
09.010-28	12""	1	0.065
09.010-32	12 1/4""	1	0.069
09.010-23	12 1/2""	1	0.068
09.010-67	12 3/4""	1	0.078
09.010-18	13""	1	0.071
09.010-19	13 1/4""	1	0.081
09.010-46	13 1/2""	1	0.083
09.010-36	13 3/4""	1	0.077
09.010-42	16""	1	0.100
09.010-45	16 1/2""	1	0.100

Round movement holder.



MSA	Calibres ""	Screws	Kg
09.010-27	3 3/4"" x 6""	1	0.034
09.010-00	3 3/4"" x 6 3/4"" x 8""	1	0.034
09.010-04	5 1/2"" x 6 3/4""	1	0.037
09.010-07	6 3/4"" x 8""	1	0.040

Special shape movement holder.



MSA	Calibres	Screws	Kg
09.010-60	(1) 762 - 763	1	0.050
09.010-61	(2) 762 - 763	-	0.050

Special shape movement holder.

(1) With 1 adjustable screw for hands fitting.
(2) Without adjustable screw for removing stems.



MSA	Calibres	Screws	Kg
09.010-55	1002 - 1009	2	0.095

Round movement holder with 2 adjustable screws.



MSA	Calibres	Screws	Kg
09.017	3520.D - 3540.D	-	0.060

Round movement holder without adjustable screw.
For removing stems.



MSA	Calibres	Screws	Pushers	Kg
09.018	3520.D - 3540.D	4	2	0.129

Round movement holder with 2 pushers and 4 adjustable screws.



MSA	Calibres	Screws	Kg
09.016-47	4002-B - 4003-B 4120-B - 4210-B 4220-B - 5010-B 5020-B - 5022-D 5030-D - 5040-B 5040-F - 5040-D 5050-B - 5050-C 5051-C - 5130-D	-	0.060

Round movement holder without adjustable screw.
For removing stems.



MSA	Calibres	Screws	Pushers	Kg
09.010-47	4002-B - 4003-B 4120-B - 4210-B 4220-B - 5010-B 5020-B - 5022-D 5030-D - 5040-B 5040-D - 5050-B 5050-C - 5051-C 5130-B - 5130-D	4	2	0.170

Round movement holder with 2 pushers and 4 adjustable screws.



MSA	Calibre	Screws	Pushers	Kg
09.010-52	5040-F	4	5	0.160

Round movement holder with 5 pushers and 4 adjustable screws.

MOVEMENT HOLDERS



MSA	Calibre	Screws	Pushers	Kg
09.010-62	8040.B	4	2	0.130

Round movement holder with 2 pushers and 4 adjustable screws.



MSA	Calibre	Screws	Pushers	Kg
09.010-53	057	1		0.042

Special shape movement holder with 1 adjustable screw.



MSA	Calibre	Screws	Pushers	Kg
09.010-64	Valjoux 72	4	2	0.090

Round movement holder with 2 pushers and 4 adjustable screws.



MSA	Calibre	Screws	Pushers	Kg
09.010-58	FP 1180	4	3	0.079

Round movement holder with 3 pushers and 4 adjustable screws.



MSA	Calibre	Screws	Pushers	Kg
09.010-39	DD 2025	1	2	0.089

Round movement holder with 2 pushers and 1 adjustable screw.



MSA	Calibres	Screws	Pushers	Kg
09.010-33	2094	1	2	0.070
09.010-29	251471	1	2	0.070
09.010-30	2894	1	2	0.093

Round movement holder with 2 pushers and 1 adjustable screw.



MSA	Calibre	Screws	Pushers	Kg
09.010-35	2892-A2	4	4	0.088

Round movement holder with 4 pushers and 4 adjustable screws.



MSA	Calibre	Screws	Pushers	Kg
09.010-40	2894-2	4	2	0.070

Round movement holder with 2 pushers and 4 adjustable screws.



MSA	Calibres	Screws	Kg
09.010-38	UNITAS 6497 - 6498	2	0.102

Round movement holder with 2 adjustable screws.



MSA	Calibre	Screws	Kg
09.010-41	7001	2	0.062

Round movement holder with 2 adjustable screws.



MSA	Calibre	Screws	Pushers	Kg
09.010-20	Valjoux 7750	2	2	0.087

Round movement holder with 2 pushers and 2 adjustable screws.

Spare part :

MSA	Item	Kg
09.010-20-V	Adjustable screw	0.001



MSA	Calibre	Screws	Pushers	Kg
09.010-59	Valjoux 7750	4	2	0.092

Round movement holder with 2 pushers and 4 adjustable screws.

MOVEMENT HOLDERS

HOROTEC



MSA	Calibres	Screws	Pushers	Kg
09.006	7750 - 7751 - 7753	5	3	0.114

Round movement holder with 3 pushers and 5 adjustable screws.

HOROTEC



MSA	Calibres	Screws	Pushers	Kg
09.012	ZE 400 - 410 - 420	2	6	0.130

Round movement holder with 6 pushers and 2 adjustable screws.

HOROTEC



MSA	Calibres	Screws	Pushers	Kg
09.011	Valjoux 7750 - 7753	4	6	0.125

Round movement holder with 6 pushers and 4 adjustable screws.

Spare parts :

MSA	Item	Kg
09.011-P	Pusher	0.001
09.011-V	Central adjustable screw	0.001



MSA	Calibre	Screws	Pushers	Kg
09.010-21	251262	4	4	0.090

Round movement holder with 4 pushers and 4 adjustable screws.



MSA	Calibre	Screws	Pushers	Kg
09.010-68	251471	4	2	0.090

Round movement holder with 2 pushers and 4 adjustable screws.



MSA	Calibres	Screws	Kg
09.010-43	PUW 111 - 282001	1	0.045

Special shape movement holder with 1 adjustable screw.



MSA	Calibre	Screws	Kg
09.010-54	980163	1	0.064

Special shape movement holder with 1 adjustable screw.



MSA	Calibre	Screws	Pushers	Kg
09.007	ETA A07	5	4	0.130

Round movement holder with 4 pushers and 5 adjustable screws.



MSA	Calibres	Screws	Pushers	Kg
09.010-44	G10211 - G10711	4	2	0.095

Round movement holder with 2 pushers and 4 adjustable screws.



MSA	Calibre	Screws	Pushers	Kg
09.010-63	G15211	4	2	0.101

Round movement holder with 2 pushers and 4 adjustable screws.

MOVEMENT HOLDERS

Aluminium movement holders.



MSA	Calibre	Kg
09.010-31	Lemania 1870	0.022

Round anodized aluminium movement holder.



MSA	Calibre	Kg
09.010-37	OM 1045	0.004

Round anodized aluminium movement holder with space for 2 pushers.



MSA	Kg	VIDE
09.010-24	0.073	
09.010-25	0.023	
09.010-26	0.035	

Anodized aluminium round movement holder with an adjustable central screw for supporting pivots and endstones.

Plastic movement holders.



MSA	Calibres	Kg
09.050-02	2824 11 1/2"	0.014
09.050-01	7750 13 1/4"	0.015

Green plastic movement holder.
Other calibres upon request.

Reversible movement holders with button.



MSA	Calibres ""	Kg
09.020-00	3 3/4" x 6"	0.016
09.021	3 3/4" x 8"	0.022
09.020-06	5 1/2" x 6 3/4"	0.012
09.020-07	6 3/4" x 8"	0.013

Nickel-plated brass reversible movement holder with button, special shape.



MSA	Calibres ""	Kg
09.020-05	5 1/2"	0.007
09.020-09	7 1/2"	0.014
09.020-08	7 3/4"	0.010
09.020-11	8 3/4"	0.010
09.020-12	9"	0.015
09.020-13	9 1/4"	0.015
09.020-10	9 1/2"	0.015
09.020-15	10 1/2"	0.015
09.020-25	11 1/4"	0.035
09.020-16	11 1/2"	0.023
09.020-19	12"	0.028
09.020-17	12 1/4"	0.020
09.020-20	12 1/2"	0.020
09.020-18	13"	0.025
09.020-22	13 1/4"	0.022
09.020-26	13 1/2"	0.025
09.020-23	13 3/4"	0.026
09.020-30	14 1/2"	0.026
09.020-27	15"	0.030
09.020-29	16"	0.035
09.020-24	16 1/2"	0.047

Nickel-plated brass reversible round movement holder with button.



MSA	Calibres ""	Kg
09.015-08	7 3/4"	0.015
09.015-11	8 3/4"	0.015
09.015-15	10 1/2"	0.016
09.015-16	11 1/2"	0.016
09.015-20	12 1/2"	0.018
09.015-22	13 1/4"	0.020
09.015-24	16 1/2"	0.024

Plexiglas reversible round movement holder with button.



MSA	Calibre	Pushers	Kg
09.020-21	Valjoux 7750	4	0.041

Nickel-plated brass reversible round movement holder with button and 4 pushers.

MOVEMENT HOLDERS

Extensible and reversible movement holders.



MSA	Calibres '''	Size	Kg
09.002	3 3/4"...12 1/2'''	60 x 25 mm	0.025

Nickel-plated brass extensible and reversible movement holder with springs.



MSA	Calibres '''	Size	Kg
09.003	3 3/4"...11'''	40 x 25 mm	0.032

Extensible and reversible steel movement holder with screw, 3 3/4"...11'''.



MSA	Calibres '''	Size	Kg
09.004	8 3/4"...19'''	50 x 37 mm	0.042

Extensible and reversible steel movement holder with screw.



MSA	Size	Kg
09.005	75 x 50 mm	0.138

Extensible and reversible steel movement holder with screw for pocket watches.



MSA	Calibres ""	Size	Kg
09.103	3 3/4" ... 11"	55 x 25 mm	0.027

Extensible and reversible synthetic movement holder with screw.
Tightening on external Ø 12...30 mm.



MSA	Calibres ""	Size	Kg
09.104	8 3/4" ... 19"	55 x 38 mm	0.028

Extensible and reversible synthetic movement holder with screw.
Tightening on external Ø 30...48 mm.

Assortment of plastic movement holders.



See chapter *PERF.*

CASE CUSHIONS

Case cushions for multi-use, made of a felt or rubber disc covered with synthetic material and reinforced with a metal or plastic ring.



MSA	Ø	Height	Kg
09.305	90 mm	15 mm	0.130

Reversible case cushion in anti scratch synthetic material. One flat side with a room for small components storage like screws, battery clamps, crowns, etc. The other side is concave to accept domed glasses of watch cases.

Delivered with anti-dust lid.



MSA	Ø	Height	Kg
09.300	50 mm	13 mm	0.026

Case cushion with chromed metallic ring.



MSA	Ø	Height	Kg
09.301	53 mm	13 mm	0.025

Case cushion with chromed metallic ring.



MSA	Ø	Height	Kg
09.302	55 mm	11 mm	0.011

Case cushion with red plastic ring.



MSA	Ø	Height	Kg
09.303	55 mm	12 mm	0.020

Case cushion with black plastic ring.



MSA	Ø	Height	Kg
09.307	84 mm	11 mm	-
09.308	76 mm	11 mm	-

Case cushion with black plastic ring.

All case cushions illustrated above, can be personalized upon request.

Synthetic case cushion.



MSA	Ø	Height	Kg
09.306	45 mm	21 mm	0.070

Casing cushion in synthetic red rubber with 1 flat face and 1 curved face.
 Ø centre hole : 12 mm.

RIVETING PLATE

Riveting plate for dials.

HOROTEC



Example of use with a dial

MSA	Ø	Height	Kg
09.310	60 mm	8 mm	0.085

Ground steel riveting plate, for holding dials.
Guaranteed flatness, ideal for inspection and gauging.

10



BRACELET PRESSES

10 - 2

BRACELET TOOLS

10 - 3

SPRING BARS TOOLS

10 - 11

BRACELET PRESSES



MSA	Size	Kg
10.500	60 x 80 x 110 mm	0.465

Press for rapidly fitting and removing the bracelet pins and screws. Stand accessories easily accessible. The vertical guide allows a perfect alignment with bracelet screws and pins. It is equipped with a device that holds the pins holder, leaving the operator hands free.

Contents :

- 1 press and 1 broach MSA10.500-A
- 1 handle MSA10.504
- 1 bracelet holder MSA10.501
- 12 blades MSA10.502-xxx (2 of each diameter)
- 11 pin punches MSA10.503-xxx : \varnothing 0.40, 0.60, 0.70, 0.80, 0.90, 1.00, 1.10, 1.20, 1.40, 1.50 and 2.00 mm
- 1 support MSA10.500-C
- 1 lower support MSA10.505
- 1 bracelet protector MSA10.500-E.



MSA	Size	Kg
10.499	60 x 80 x 110 mm	0.415

Press for fitting and removing the bracelet pins.
Simple version of press MSA10.500.

Contents :

- 1 press and 1 broach MSA10.500-A
- 1 bracelet holder MSA10.501
- 6 pin punches MSA10.503-xxx : \varnothing 0.40, 0.60, 0.80, 1.00, 1.50 and 2.00 mm
- 1 support MSA10.500-C.



Spare parts for MSA10.499 and MSA10.500 :

MSA	Item	Kg
10.499-03	Centering pin for base MSA10.499, \varnothing 4 x 17 mm	0.001
10.500-A	Broach for pin punch ; bore \varnothing 2 mm, length 80 mm	0.021
10.500-B	O-Ring gasket for broach MSA10.500-A (old version) and handle MSA10.504 ; \varnothing 3 mm, T 1.00	0.001
10.500-C	Support for the bracelet holder MSA10.501	0.003
10.500-D	Steel ball for broach MSA10.500-A and handle MSA10.504	0.001
10.500-E	Delrin® bracelet protector in slotted tulip shape	0.001
10.500-F	Maintaining ring (POM) of ball MSA10.500-D on broach MSA10.500-A	0.001
10.504	Knurled handle for blades MSA10.502-x ; length 84 mm	0.022
10.505	Lower support for blades MSA10.502-x and bracelet protector MSA10.500-E	0.013

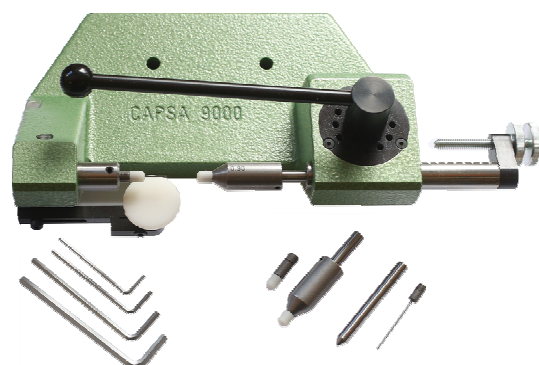

MSA	Size	Kg
10.550	290 x 140 x 120 mm	5.750

Device for fitting the bracelet pins.

Contents :

- 1x MSA10.550-TD090 : Complete chuck with pin Ø 0.90 mm and Delrin® end piece, right-hand side
- 1x MSA10.550-TD110 : Complete chuck with pin Ø 1.10 mm and Delrin® end piece, right-hand side
- 1x MSA10.550-TG080 : Complete chuck with pin Ø 0.80 mm and Delrin® end piece, left-hand side
- 1x MSA10.550-TG100 : Complete chuck with pin Ø 1.00 mm and Delrin® end piece, left-hand side
- 1x MSA10.550-PC : Hollowed point
- 1y set of Allen keys.

Spare parts and accessories :

MSA	Item	MSA	Item
10.550-AD060	(1) Pin for right-hand chuck, L35 x Ø 0.60 mm	10.550-PC	(3) Hollowed point
10.550-AD070	Pin for right-hand chuck, L35 x Ø 0.70 mm	10.550-RR	(4) Return spring
10.550-AD080	Pin for right-hand chuck, L35 x Ø 0.80 mm	10.550-RTD	(5) Spring for chuck left side
10.550-AD090	Pin for right-hand chuck, L35 x Ø 0.90 mm	10.550-RTG	(6) Spring for chuck right side
10.550-AD100	Pin for right-hand chuck, L35 x Ø 1.00 mm	10.550-TD070	Complete chuck with pin Ø 0.70 mm and Delrin® end piece right-hand side
10.550-AD110	Pin for right-hand chuck, L35 x Ø 1.10 mm	10.550-TD080	Complete chuck with pin Ø 0.80 mm and Delrin® end piece right-hand side
10.550-AD120	Pin for right-hand chuck, L35 x Ø 1.20 mm	10.550-TD090	Complete chuck with pin Ø 0.90 mm and Delrin® end piece right-hand side
10.550-AD130	Pin for right-hand chuck, L35 x Ø 1.30 mm	10.550-TD100	(7) Complete chuck with pin Ø 1.00 mm and Delrin® end piece right-hand side
10.550-AD140	Pin for right-hand chuck, L35 x Ø 1.40 mm	10.550-TD110	Complete chuck with pin Ø 1.10 mm and Delrin® end piece right-hand side
10.550-AG060	Pin for left-hand chuck, L40 x Ø 0.60 mm	10.550-TD120	Complete chuck with pin Ø 1.20 mm and Delrin® end piece right-hand side
10.550-AG070	Pin for left-hand chuck, L40 x Ø 0.70 mm	10.550-TD140	Complete chuck with pin Ø 1.40 mm and Delrin® end piece right-hand side
10.550-AG080	Pin for left-hand chuck, L40 x Ø 0.80 mm	10.550-TG060	Complete chuck with pin Ø 0.60 mm and Delrin® end piece left-hand side
10.550-AG090	Pin for left-hand chuck, L40 x Ø 0.90 mm	10.550-TG070	Complete chuck with pin Ø 0.70 mm and Delrin® end piece left-hand side
10.550-AG100	Pin for left-hand chuck, L40 x Ø 1.00 mm	10.550-TG080	Complete chuck with pin Ø 0.80 mm and Delrin® end piece left-hand side
10.550-AG110	Pin for left-hand chuck, L40 x Ø 1.10 mm	10.550-TG090	(8) Complete chuck with pin Ø 0.90 mm and Delrin® end piece left-hand side
10.550-AG120	Pin for left-hand chuck, L40 x Ø 1.20 mm	10.550-TG100	Complete chuck with pin Ø 1.00 mm and Delrin® end piece left-hand side
10.550-AG130	Pin for left-hand chuck, L40 x Ø 1.30 mm	10.550-TG110	Complete chuck with pin Ø 1.10 mm and Delrin® end piece left-hand side
10.550-AG140	Pin for left-hand chuck, L40 x Ø 1.40 mm	10.550-TG120	Complete chuck with pin Ø 1.20 mm and Delrin® end piece left-hand side
10.550-EDD050	(2) Delrin® end piece right-hand, hole Ø 0.50 mm	10.550-TG130	Complete chuck with pin Ø 1.30 mm and Delrin® end piece left-hand side
10.550-EDD060	Delrin® end piece right-hand, hole Ø 0.60 mm		
10.550-EDD070	Delrin® end piece right-hand, hole Ø 0.70 mm		
10.550-EDD080	Delrin® end piece right-hand, hole Ø 0.80 mm		
10.550-EDD090	Delrin® end piece right-hand, hole Ø 0.90 mm		
10.550-EDD100	Delrin® end piece right-hand, hole Ø 1.00 mm		
10.550-EDD110	Delrin® end piece right-hand, hole Ø 1.10 mm		
10.550-EDD120	Delrin® end piece right-hand, hole Ø 1.20 mm		
10.550-EDD130	Delrin® end piece right-hand, hole Ø 1.30 mm		
10.550-EDD140	Delrin® end piece right-hand, hole Ø 1.40 mm		
10.550-EDG050	Delrin® end piece left-hand, hole Ø 0.50 mm		
10.550-EDG060	Delrin® end piece left-hand, hole Ø 0.60 mm		
10.550-EDG070	Delrin® end piece left-hand, hole Ø 0.70 mm		
10.550-EDG080	Delrin® end piece left-hand, hole Ø 0.80 mm		
10.550-EDG090	Delrin® end piece left-hand, hole Ø 0.90 mm		
10.550-EDG100	Delrin® end piece left-hand, hole Ø 1.00 mm		
10.550-EDG110	Delrin® end piece left-hand, hole Ø 1.10 mm		
10.550-EDG120	Delrin® end piece left-hand, hole Ø 1.20 mm		
10.550-EDG130	Delrin® end piece left-hand, hole Ø 1.30 mm		
10.550-EDG140	Delrin® end piece left-hand, hole Ø 1.40 mm		

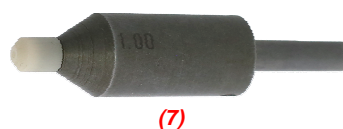
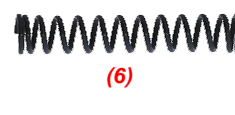
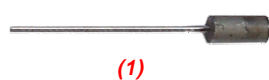

BRACELET TOOLS



MSA	Ø	Kg
10.502-080	0.80 mm	0.004
10.502-100	1.00 mm	0.004
10.502-120	1.20 mm	0.004
10.502-140	1.40 mm	0.004
10.502-160	1.60 mm	0.004
10.502-250	2.50 mm	0.006

Blade for press MSA10.500 (shank Ø 2 mm).

MSA	Quantity	Kg
10.502-A	2x 6 blades	0.006

Assortment of 12 blades for press MSA10.500.



MSA	Ø	Kg
10.503-040	0.40 mm	0.005
10.503-060	0.60 mm	0.005
10.503-070	0.70 mm	0.005
10.503-080	0.80 mm	0.005
10.503-090	0.90 mm	0.005
10.503-100	1.00 mm	0.005
10.503-110	1.10 mm	0.005
10.503-120	1.20 mm	0.005
10.503-140	1.40 mm	0.005
10.503-150	1.50 mm	0.005
10.503-200	2.00 mm	0.005

Pin punches for presses MSA10.499 et MSA10.500 + tools MSA10.510 and MSA10.511 (shank Ø 2 mm).

MSA	Quantity	Kg
10.503-A	11 pin punches	0.060
10.503-B	10 pin punches	0.050
10.503-C	6 pin punches	0.040

Assortment of pin punches for presses MSA10.499 et MSA10.500 + tools MSA10.510 and MSA10.511 (shank Ø 2 mm).

MSA10.503-A : MSA10.503-B : MSA10.503-C :

MSA10.503-040	MSA10.503-040	MSA10.503-040
MSA10.503-060	MSA10.503-060	MSA10.503-060
MSA10.503-070	MSA10.503-070	MSA10.503-080
MSA10.503-080	MSA10.503-080	MSA10.503-100
MSA10.503-090	MSA10.503-090	MSA10.503-150
MSA10.503-100	MSA10.503-100	MSA10.503-200
MSA10.503-110	MSA10.503-120	
MSA10.503-120	MSA10.503-140	
MSA10.503-140	MSA10.503-150	
MSA10.503-150	MSA10.503-200	
MSA10.503-200		



MSA	Size	Kg
10.510	95 x 80 x 36 mm	0.295

Pin punch tool with 1 universal bracelet holder on a wooden base.

Contents :

- 1 pin punch tool MSA10.510-A.
- 1 bracelet holder MSA10.501.
- 10 pin punches MSA10.503-xxx : Ø 0.40, 0.60, 0.70, 0.80, 1.00, 1.10, 1.20, 1.40, 1.50 and 2.00 mm
- 1 wooden base MSA10.510-B.



MSA	Kg
10.511	0.040

Pin punch tool with 1 universal bracelet holder.

Contents :

- 1 pin punch tool MSA10.510-A
- 1 bracelet holder MSA10.501
- 4 pin punches MSA10.503-xxx : Ø 0.40, 0.60, 0.80 and 1.00 mm.



MSA	Length	Ø reaming	Kg
10.510-A	80 mm	2.00 mm	0.029

Metal knurled pin punch tool.

Accessory for MSA10.510 and MSA10.511.



MSA	Packaging size	Kg
10.533	85 x 55 x 15 mm	0.040

Pin punch tool with anodised brass handle and stainless steel anvil.

Contents :

- 1 handle MSA10.527 compatible with all pin punches MSA10.503-x
- 11 pin punches MSA10.503-x : Ø 0.40, 0.60, 0.70, 0.80, 0.90, 1.00, 1.10, 1.20, 1.40, 1.50 and 2.00 mm.

Spare parts :

MSA	Item	Kg
10.503-040	Pin punch Ø 0.40 mm	0.005
10.503-060	Pin punch Ø 0.60 mm	0.005
10.503-070	Pin punch Ø 0.70 mm	0.005
10.503-080	Pin punch Ø 0.80 mm	0.005
10.503-090	Pin punch Ø 0.90 mm	0.005
10.503-100	Pin punch Ø 1.00 mm	0.005
10.503-110	Pin punch Ø 1.10 mm	0.005
10.503-120	Pin punch Ø 1.20 mm	0.005
10.503-140	Pin punch Ø 1.40 mm	0.005
10.503-150	Pin punch Ø 1.50 mm	0.005
10.503-200	Pin punch Ø 2.00 mm	0.005
10.527	(1) Handle, Ø 6 x length 54 mm	0.011



(1)



MSA	Packaging size	Kg
10.534	85 x 55 x 15 mm	0.031

Pin punch tool with anodised brass handle and stainless steel anvil.

Contents :

- 1 handle MSA10.527 compatible with all pin punches MSA10.503-x
- 3 pin punches MSA10.503-x : Ø 0.70, 0.80 and 1.00.

Spare parts :

MSA	Item	Kg
10.503-070	Pin punch Ø 0.70 mm	0.005
10.503-080	Pin punch Ø 0.80 mm	0.005
10.503-100	Pin punch Ø 1.00 mm	0.005
10.527	(1) Handle, Ø 6 x length 54 mm	0.011



MSA	Packaging size	Kg
10.528	85 x 55 x 15 mm	0.037

Assortment of pin punch tools for removing the bracelet pins.

Contents :

- 1 pin punch tool MSA10.528-070 with nickel plated brass handle Ø 5 mm, Ø 0.70 mm
- 1 pin punch tool MSA10.528-080 with nickel plated brass handle Ø 5 mm, Ø 0.80 mm
- 1 pin punch tool MSA10.528-100 with nickel plated brass handle Ø 5 mm, Ø 1.00 mm.

Spare parts :

MSA	Item	Kg
10.528-070	Pin punch tool with handle Ø 5 mm, Ø 0.70 mm	0.006
10.528-080	Pin punch tool with handle Ø 5 mm, Ø 0.80 mm	0.006
10.528-100	(1) Pin punch tool with handle Ø 5 mm, Ø 1.00 mm	0.006
10.529-070	Pin punch Ø 0.70 mm, total/usable length 22/15 mm	0.001
10.529-080	Pin punch Ø 0.80 mm, total/usable length 22/15 mm	0.001
10.529-100	(2) Pin punch Ø 1.00 mm, total/usable length 22/15 mm	0.001
10.529-V	(3) Screw for pin punch tools	0.001

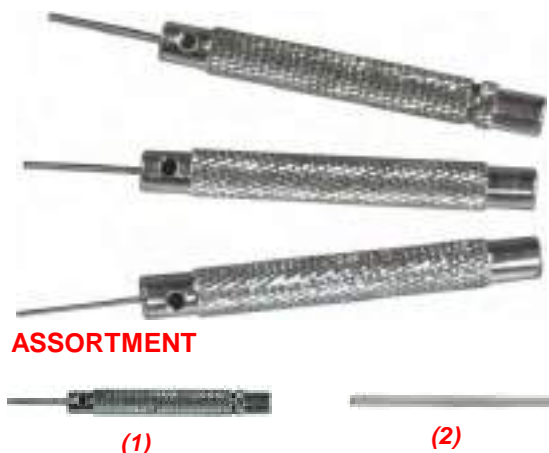

ASSORTMENT

MSA	Kg
10.508	0.029

Assortment of 3 pin punches tools (Ø 0.60, 0.80 and 1.00 mm) for removing the bracelet pins.

Spare parts :

MSA	Item	Kg
10.508-060	(1) Tool with handle Ø 5.20, length 52.60, pin Ø 0.60 mm	0.006
10.508-080	Tool with handle Ø 5.20, length 52.60, pin Ø 0.80 mm	0.006
10.508-100	Tool with handle Ø 5.20, length 52.60, pin Ø 1.00 mm	0.006
10.509-060	(2) Pin punches Ø 0.60 mm	0.001
10.509-080	Pin punches Ø 0.80 mm	0.001
10.509-100	Pin punches Ø 1.00 mm	0.001



MSA	Size	Kg
10.501	52 x 52 x 25 mm	0.022

Universal black plastic bracelet holder, with 9 holes and 8 slots of 2.8 to 6.3 mm.

Accessory for MSA10.499, 10.500, 10.510 and 10.511.



MSA	Size	Kg
10.507	55 x 55 x 40 mm	0.030

Black plastic bracelet holder, 22 slots of 3.5 to 9.0 mm.



MSA	Size	Kg
10.519	50 x 45 x 40 mm	0.105

Bracelet holder vice with screw.

- Maximum bracelet thickness : 10 mm
- Useful dimensions : length 49 mm and height 24 mm
- Suitable for presses MSA10.499 and 10.500 illustrated on page 10-2.



MSA	Size	Kg
10.513	55 x 35 x 22 mm	0.050

Bracelet holder vice with screw.

- Maximum bracelet thickness : 9.50 mm
- Useful dimensions : length 35 mm and height 12 mm
- Suitable for presses MSA10.499 and 10.500 illustrated on page 10-2.



MSA	Size	Kg
10.010	110 x 70 x 75 mm	1.100

Multifunctional 3rd hand vice, case holder and bracelet holder.

Composition :

- 1 base with table equipped with a POM protection Ø 25 mm
- 1 removable and sliding vice for tightening cases and bracelets ; maximum opening 30 mm
- 4 stainless steel blades (hardening 57 HRC) Ø 1.00, 1.40, 1.80 and 3.00 mm. Shank Ø 3 mm.

Spare parts :

MSA	Item	Kg
10.010-100	Blade Ø 1.00 mm	0.005
10.010-140	Blade Ø 1.40 mm	0.005
10.010-180	Blade Ø 1.80 mm	0.005
10.010-300	Blade Ø 3.00 mm	0.005
10.010-A	Maintaining screw	0.010
10.010-B	Blade spring	0.001



MSA	Size	Kg
10.520	25 x 25 x 27 mm	0.037

Small tool for bracelet screws.

- 3 blades Ø 1.00, 1.40 and 3.00 mm
- Metal anti-skid base.



MSA	Size	Kg
10.007	105 x 60 x 60 mm	0.355

Tool to keep plastic band watches opened.

Give free hands to users for easy works in the watch.

Non-skid aluminium base and curved Delrin® die Ø 39 mm (also for domed crystals).



MSA	Size	Kg
10.531	110 x 50 x 25 mm	0.066

Tool for removing bracelet pins.

Spare part :

MSA	Item	Kg
10.531-A	(1) Pin punch Ø 0.80 mm, shank Ø 1.90mm	0.003





MSA	Size	Kg
10.005	60 x 20 x 25 mm	0.015

Small black plastic tool for removing the bracelet pins.
 Delivered with 2 pin punches \varnothing 0.80 mm.

Spare part :

MSA	Item	Kg
10.005-A	(1) Pin punch \varnothing 0.80, body \varnothing 2.50, length 31.40 mm	0.001



MSA	Size	Kg
10.532	55 x 22 x 25 mm	0.016

Small black plastic tool for removing the bracelet pins.
 Delivered with 3 pin punches \varnothing 0.80 mm (2x length 17 mm and 1x length 20 mm).

Spare parts :

MSA	Item	Kg
10.532-A	(1) Pin punches \varnothing 0.80, body \varnothing 2.50, length 17 mm	0.004
10.532-B	(2) Pin punches \varnothing 0.80, body \varnothing 2.50, length 20 mm	0.004

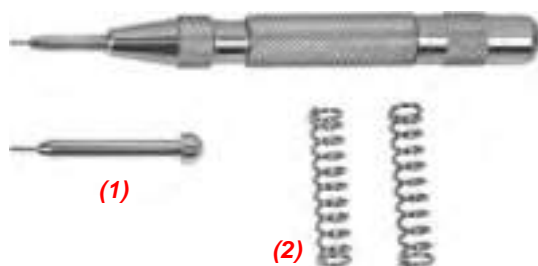

MSA	Kg
10.008	0.072

Shock tool for removing the bracelet pins.
 Delivered in a plastic pouch with :
 - 1 pin MSA10.008-A
 - 2 springs MSA10.008-B.

Spare parts :

MSA	Item	Kg
10.008-A	(1) Pin \varnothing 0.80 mm	0.004
10.008-B	(2) Spring \varnothing 8.00 x 38.00 mm	0.004



MSA	Length	Kg
10.003	145 mm	0.089

Combination pliers for fitting and removing the bracelet pins.
 Delivered with 1 pin punch holder + 1 mounted pin punch and 5 pin punches
 Ø 0.80 mm.

Spare parts :

MSA	Item	Kg
10.003-A	(1) Pin punch holder + 1 pin punch, length 36 mm, shank Ø 4 mm	0.001
10.003-B	(2) Pin punch Ø 0.80 mm, length 13.50 mm, shank Ø 1.50 mm	0.001



MSA	Length	Kg
10.006	150 mm	0.295

Combination pliers for fitting and removing the bracelet pins.
 Delivered with 5 pin punches Ø 0.60, 0.80, 1.00, 1.20 and 1.50 mm.

Spare parts :

MSA	Item	Kg
10.004-060	Pin punches Ø 1.50, length 49.00 mm	0.001
10.004-080	Pin punches Ø 1.20, length 48.50 mm	0.001
10.004-100	(1) Pin punches Ø 1.00, length 47.50 mm	0.001
10.004-120	Pin punches Ø 0.80, length 47.00 mm	0.001
10.004-150	Pin punches Ø 0.60, length 47.00 mm	0.001



Spring bars bending tool.



MSA	Size	Kg
10.311	130 x 30 x 80 mm	0.120

Tool with lever of 110 mm allowing to easily bend some of the most thickest steel spring bars.
Equipped with 2 spring bar rooms to give wished bending according to length, without damaging the spring bar.

Spare part :

MSA	Item	Kg
10.311-08	(1) Lever spring	0.001

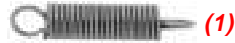

Spring bars tools.

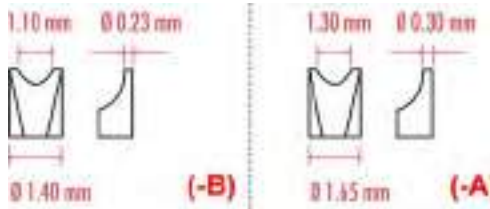

MSA	Length	Kg
10.009	130 mm	0.077

Black tool for spring bars with 2 hardened stainless steel forks MSA10.009-B (HRC 54 ±2).

Spare parts :

MSA	Item	Kg
10.009-A	Fork, width 1.30 x thickness 0.30 mm	0.002
10.009-B	Fork, width 1.10 x thickness 0.23 mm	0.002

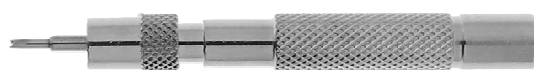

MSA	Kg
10.300	?

Tool for fitting and removing spring bars, with nickel-plated brass handle Ø 7 x length 64 mm.

- 1 reversible tip MSA10.302-A.

Spare parts :

MSA	Item	Kg
10.302-A	(1) Reversible tip (tip Ø 0.80 mm x fork width 1.20 mm)	0.004
10.302-C	(3) Reversible tip (hollowed tip Ø 0.80 mm x fork width 1.00 mm)	0.004



SPRING BARS TOOLS

HOROTEC



MSA	Material	Length	Kg
10.306	Stainless steel, sand-blasted body and mirror polished tips	120 mm	0.022
10.307	Stainless steel	120 mm	0.022

Tool for fitting and removing spring bars.

Specially made to shorten both ends of the spring bars at the same time and insert the well-adjusted metal bracelet between watch case legs.

The opening of the tips is sufficient to allow the tool to be used with any spring bars lengths.

Tips thickness : 0.50 mm.

Width of tips over 7 mm : 1.50 mm (MSA10.306) ; 1.60 mm (MSA10.307)

HOROTEC



MSA	Length	Kg
10.309	140 mm	0.021

Tool for fitting and removing spring bars.

- Aluminium anodised red handle Ø 8 mm
- Stainless steel tip and fork.

The fixing of the tips and forks on the handle is secured by 2 stainless steel M2 screws.



(3)

Spare parts :

MSA	Item	Kg
10.309-A	(1) Tip Ø 0.80 mm, threading M3	0.006
10.309-B	(2) Fork width 1.20 mm, threading M3	0.006
10.309-V	(3) Screw, threading M2	0.001

HOROTEC



(1)



(2)



(3)

MSA	Length	Kg
10.313	135 mm	0.034

Tool for fitting and removing spring bars.

- Aluminium anodised black handle Ø 8 mm
- Stainless steel reversible tip and fork easily interchangeable due to maintaining chucks.

Spare parts :

MSA	Item	Kg
10.302-A	(1) Reversible tip (tip Ø 0.80 mm x fork width 1.20 mm)	0.004
10.302-B	(2) Fork width 4.00 mm	0.004
10.302-C	(3) Reversible tip (hollowed tip Ø 0.80 mm x fork width 1.00 mm)	0.004

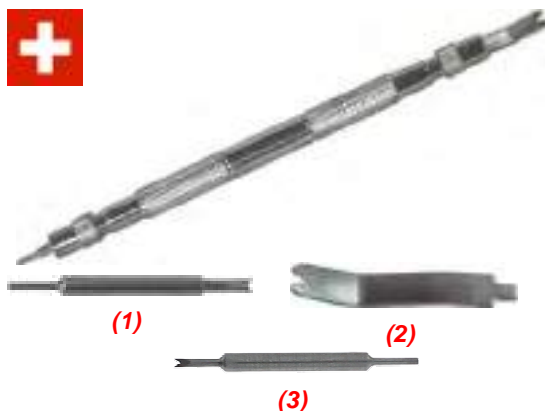

MSA	Length	Kg
10.302	135 mm	0.034

Tool for fitting and removing spring bars (CAP 9001).
 - Nickel-plated brass handle Ø 7 mm, length 110 mm
 - Steel tips easily interchangeable due to maintaining chucks.

Spare parts :

MSA	Item	Kg
10.302-A	(1) Reversible tip (tip Ø 0.80 mm x fork width 1.20 mm)	0.004
10.302-B	(2) Fork width 4.00 mm	0.004
10.302-C	(3) Reversible tip (hollowed tip Ø 0.80 mm x fork width 1.00 mm)	0.004



MSA	Length	Kg
10.304	147 mm	0.025

Tool for fitting and removing spring bars.
 - Aluminium hexagonal handle Ø 10 mm with 2 graduated scales in millimetres and inches
 - Interchangeable hardened steel tips.

* Delivered with tip MSA10.304-A and fork MSA10.304-B

Spare parts :

MSA	Item	Kg
10.304-A *	(1) Tip Ø 0.80 mm	0.001
10.304-B *	(2) Fork width 3.00 mm	0.001
10.304-C	Fork width 1.20 mm	0.001



MSA	Length	Kg
10.301	105 mm	0.007

Tool for fitting and removing spring bars.
 - Knurled aluminium handle Ø 6 mm with graduated scale in mm
 - Interchangeable steel tips.

Spare parts :

MSA	Item	Kg
10.301-A	(1) Tip Ø 0.70 mm	0.006
10.301-B	(2) Fork width 2.00 mm	0.006

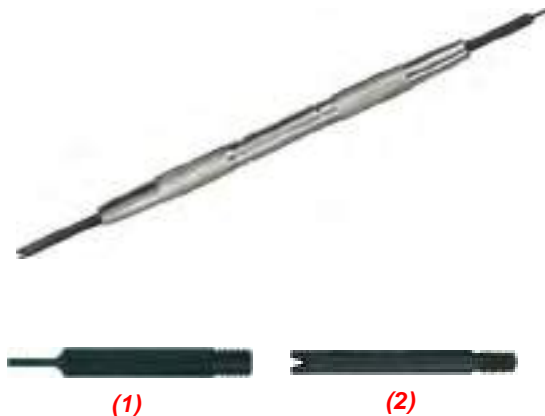

MSA	Length	Kg
10.303	145 mm	0.028

Tool for fitting and removing spring bars.
 - Knurled steel handle
 - Interchangeable hardened steel tips.

* Delivered with tip MSA10.304-A and fork MSA10.304-B

Spare parts :

MSA	Item	Kg
10.304-A *	(1) Tip Ø 0.80 mm	0.001
10.304-B *	(2) Fork width 3.00 mm	0.001
10.304-C	Fork width 1.20 mm	0.001

11



PRECITEC® PLIERS

11 - 2

GERMAN PRECISION PLIERS

11 - 13

EREM® PLIERS

11 - 18

LINDSTROM® PLIERS

11 - 20

SPECIAL PLIERS

11 - 23

PLIERS ASSORTMENTS

11 - 26

PRECITEC® pliers made of hardened steel ideal for all current work.

PRECITEC

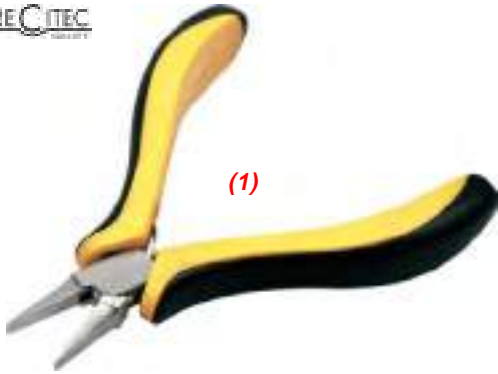

MSA	Length	Return springs	Kg
11.800-A (1)	115 mm	2	0.080
11.800-B	130 mm	-	0.100

Flat nose pliers.
Box joint construction.



PRECITEC



MSA	Length	Return springs	Kg
11.809	130 mm	-	0.097

Flat nose pliers, serrated anti-skid interior, without return springs.
Box joint construction.



PRECITEC



MSA	Length	Return springs	Kg
11.807	130 mm	-	0.096

Round and flat nose pliers, without return springs.
Box joint construction.



PRECITEC



MSA	Length	Return springs	Kg
11.805	130 mm	-	0.096

Flat and convex nose precision pliers, without return springs.
Box joint construction.





MSA	Length	Return springs	Kg
11.801-A (1)	115 mm	2	0.073
11.801-B	130 mm	-	0.090

Round nose pliers.
Box joint construction.



MSA	Length	Return springs	Kg
11.806	130 mm	-	0.096

Round and concave nose pliers, without return springs.
Box joint construction.

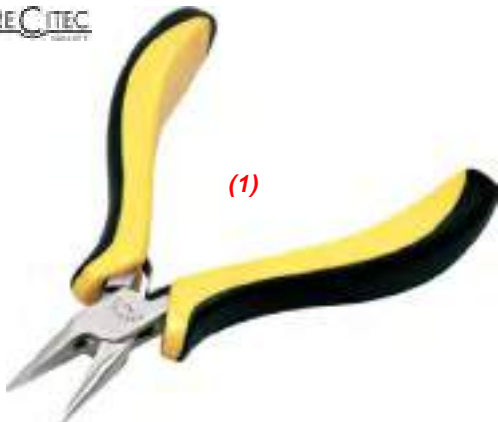

MSA	Length	Return springs	Kg
11.802-A (1)	115 mm	2	0.073
11.802-B	130 mm	-	0.095

Half-round nose pliers.
Box joint construction.

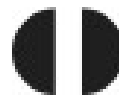

MSA	Length	Return springs	Kg
11.810	135 mm	2	0.140

Side cutting pliers, with 2 return springs.
Box joint construction.



PRECITEC® PLIERS

PRECITEC
SWISS



MSA	Length	Cutting	Return springs	Kg
11.820	130 mm	Bevelled	2	0.146

End cutting pliers, with 2 return springs.
Box joint construction.



PRECITEC
SWISS



MSA	Length	Cutting	Return springs	Kg
11.827	130 mm	Bevelled	2	0.120

End cutting pliers made of tungsten carbide, with 2 return springs.
Box joint construction.



PRECITEC
SWISS



MSA	Length	Cutting	Return springs	Kg
11.828	130 mm	Bevelled	2	0.110

Side cutting pliers made of tungsten carbide, with 2 return springs.
Box joint construction.



PRECITEC
SWISS



MSA	Length	Cutting	Return springs	Kg
11.829	110 mm	Plain	2	0.090

Side cutting pliers made of tungsten carbide, with rounded head and 2 return springs.
Screw lap joint construction.





MSA	Length	Cutting	Return springs	Kg
11.830	120 mm	Plain	2	0.095

Side cutting pliers made of tungsten carbide, with three-square head and 2 return springs.
Screw lap joint construction.



MSA	Length	Cutting width	Return springs	Kg
11.105	130 mm	1.70 mm	2	0.107
11.106	130 mm	3.00 mm	2	0.115

Leather watch strap notching cutters, with 2 return springs.
Box joint construction.



MSA	Length	Ø perforation	Return springs	Kg
11.816	145 mm	2.00 mm	2	0.150

Leather straps hole punching pliers, with 2 return springs.
Box joint construction.



MSA	Length	Return springs	Kg
11.812	135 mm	-	0.095

Pliers for removing bracelet links, without return springs.
Box joint construction.





MSA	Length	Return springs	Kg
11.808	135 mm	-	0.128

Pliers with interchangeable jaws in Nylon®, width 10 mm, without return springs.
Box joint construction.

Spare parts :

MSA	Item	Kg
11.808-1	Nylon® jaw	0.002
11.808-2	Jaw screw	0.001



MSA	Kg
11.803	0.345

Assortment of 3 pliers, with 2 return springs.
Box joint construction.
Delivered on a wooden stand.

Contents :

MSA	Item	Kg
11.801-A	(1) Round nose pliers	0.073
11.802-A	(2) Half-round nose pliers	0.073
11.800-A	(3) Flat nose pliers	0.080



MSA	Kg
11.804	0.440

Assortment of 3 pliers, without return springs.
Box joint construction.
Delivered on a wooden stand.

Contents :

MSA	Item	Kg
11.802-B	(1) Half-round nose pliers	0.095
11.801-B	(2) Round nose pliers	0.090
11.800-B	(3) Flat nose pliers	0.100





MSA	Kg
11.813	0.415

Assortment of 3 pliers, without return springs.
Box joint construction.
Delivered on a wooden stand.

Contents :

MSA	Item	Kg
11.800-B	(1) Flat nose pliers	0.100
11.812	(2) Pliers for removing bracelet links	0.095
11.802-B	(3) Half-round nose pliers	0.095



MSA	Kg
11.817	0.445

Assortment of 3 pliers.
Box joint construction.
Delivered on a wooden stand.

Contents :

MSA	Item	Kg
11.812	(1) Pliers for removing bracelet links	0.095
11.809	(2) Flat nose pliers, serrated anti-skid interior	0.097
11.816	(3) Leather straps hole punching pliers	0.150



MSA	Kg
11.818	0.450

Assortment of 3 pliers.
Box joint construction.
Delivered on a wooden stand.

Contents :

MSA	Item	Kg
11.827	(1) End cutting pliers, bevelled cutting	0.102
11.801-B	(2) Round nose pliers	0.090
11.809	(3) Flat nose pliers, serrated anti-skid interior	0.097





MSA	Kg
11.831	0.408

Assortment of 3 pliers, with 2 return springs.
 Delivered on a wooden stand.

Contents :

MSA	Item	Kg
11.829	(1) Side cutting pliers, plain cutting	0.090
11.828	(2) Side cutting pliers, bevelled cutting	0.110
11.827	(3) End cutting pliers, bevelled cutting	0.102



MSA	Kg
11.832	0.606

Assortment of 5 pliers, with 2 return springs.
 Delivered on a wooden stand.

Contents :

MSA	Item	Kg
11.820	(1) End cutting pliers, bevelled cutting	0.146
11.810	(2) Side cutting pliers, bevelled cutting	0.140
11.802-A	(3) Half-round nose pliers	0.073
11.801-A	(4) Round nose pliers	0.073
11.800-A	(5) Flat nose pliers	0.080

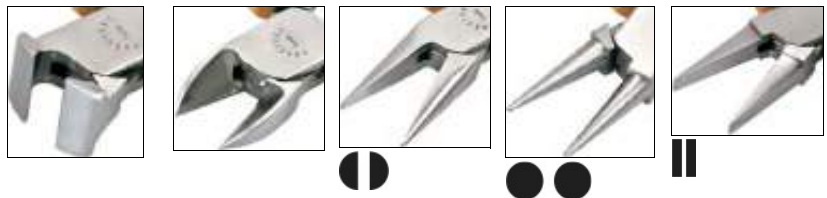



MSA	Length	Return springs	Kg
11.833-B	130 mm	-	0.092

Flat nose pliers, without return springs.
Box joint construction.



MSA	Length	Return springs	Kg
11.836	130 mm	-	0.090

Flat and convex nose pliers, without return springs.
Box joint construction.



MSA	Length	Return springs	Kg
11.834-A (1)	115 mm	2	0.078
11.834-B	130 mm	-	0.097

Round nose pliers.
Box joint construction.

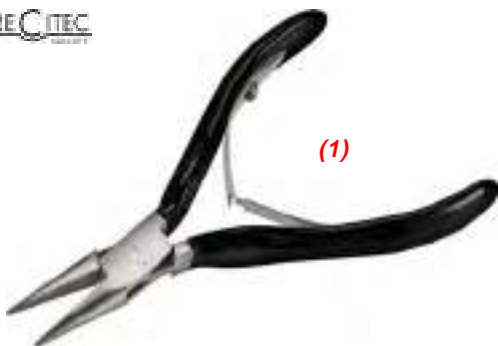

MSA	Length	Return springs	Kg
11.835-A (1)	115 mm	2	0.075
11.835-B	130 mm	-	0.097

Half-round nose pliers.
Box joint construction.

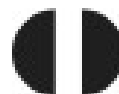

PRECITEC® PLIERS

PRECITEC
SWISS MADE



MSA	Length	Cutting	Return springs	Kg
11.837	130 mm	000	2	0.092

Side cutting pliers, with 2 return springs.
Box joint construction.



PRECITEC
SWISS MADE



MSA	Kg
11.840	0.395

Assortment of 3 pliers, without return springs.
Delivered on a wooden stand.

Contents :

MSA	Item	Kg
11.833-B	(1) Flat nose pliers	0.092
11.834-B	(2) Round nose pliers	0.097
11.835-B	(3) Half-round nose pliers	0.097

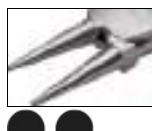



MSA	Length	Return springs	Kg
11.851	140 mm	-	0.087

Flat nose pliers with black anti-skid handles.
Lap joint construction.



MSA	Length	Return springs	Kg
11.852	140 mm	-	0.090

Round nose pliers with red anti-skid handles.
Lap joint construction.



MSA	Length	Return springs	Kg
11.853	140 mm	-	0.085

Half-round nose pliers with green anti-skid handles.
Lap joint construction.

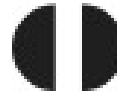
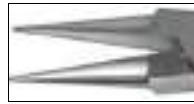

MSA	Length	Cutting	Return springs	Kg
11.854	140 mm	000	-	0.108

End cutting pliers with yellow anti-skid handles.
Lap joint construction.

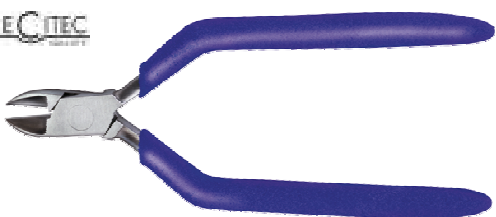

MSA	Length	Cutting	Return springs	Kg
11.855	140 mm	000	-	0.094

Side cutting pliers with blue anti-skid handles.
Lap joint construction.





MSA	Kg
11.856	0.645

Assortment of 5 pliers with anti-skid handles.
Delivered on a wooden stand.

Contents :

MSA	Item	Kg
11.852	(1) Round nose pliers	0.090
11.853	(2) Half-round nose pliers	0.085
11.851	(3) Flat nose pliers	0.087
11.854	(4) End cutting pliers	0.108
11.855	(5) Side cutting pliers	0.094



MSA	Kg
11.857	0.406

Assortment of 3 pliers with anti-skid handles.
Delivered on a wooden stand.

Contents :

MSA	Item	Kg
11.852	(1) Round nose pliers	0.090
11.853	(2) Half-round nose pliers	0.085
11.851	(3) Flat nose pliers	0.087

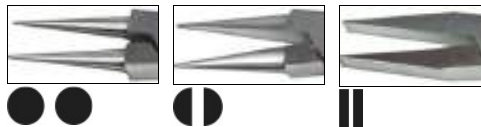

Excellent quality, robust and reliable german precision pliers with box joint construction ; with 2 return springs and available in several variants for precision work.



MSA		Noses length	Total length	Kg
11.200-A	(1)	22 mm	115 mm	0.060
11.200-B	(2)	25 mm	130 mm	0.075
11.200-C	(3)	40 mm	145 mm	0.090

Flat nose precision pliers.
PVC protected handles and 2 return springs.
Box joint construction.

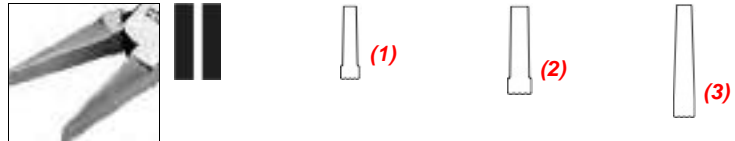

MSA		Noses length	Total length	Kg
11.199		21 mm	115 mm	0.062

Serrated flat nose precision pliers.
PVC protected handles and 2 return springs.
Box joint construction.



MSA		Noses length	Total length	Kg
11.215		25 mm	130 mm	0.083

Flat and convex nose precision pliers.
PVC protected handles and 2 return springs.
Box joint construction.



MSA		Noses length	Total length	Kg
11.201-A	(1)	22 mm	115 mm	0.058
11.201-B	(2)	25 mm	130 mm	0.073
11.201-C	(3)	40 mm	145 mm	0.087

Round nose precision pliers.
PVC protected handles and 2 return springs.
Box joint construction.

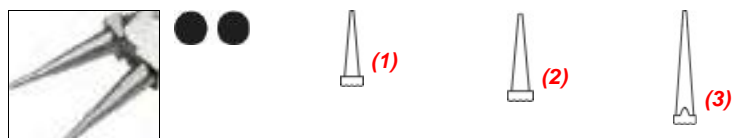

GERMAN PRECISION PLIERS



MSA	Noses length	Total length	Kg
11.216	25 mm	130 mm	0.090

Round and concave nose precision pliers.
PVC protected handles and 2 return springs.
Box joint construction.



MSA	Noses length	Total length	Kg
11.202-A	(1) 22 mm	115 mm	0.062
11.202-B	(2) 25 mm	130 mm	0.074
11.202-C	(3) 40 mm	145 mm	0.090

Half-round nose precision pliers.
PVC protected handles and 2 return springs.
Box joint construction.

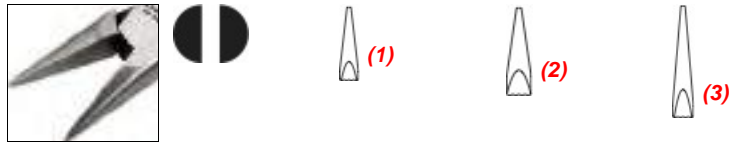

MSA	Noses length	Total length	Kg
11.203-C	40 mm	145 mm	0.088

Long half-round nose precision pliers.
PVC protected handles and 2 return springs.
Box joint construction.

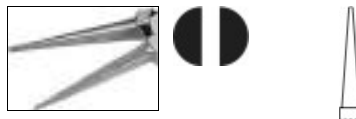

MSA	Noses length	Total length	Kg
11.203-D	63 mm	170 mm	0.112

Extra-long half-round nose precision pliers.
PVC protected handles and 2 return springs.
Box joint construction.

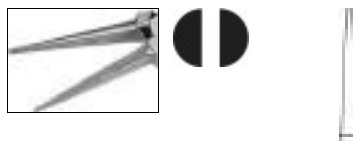



MSA	Noses length	Total length	Kg
11.205-C	40 mm	145 mm	0.088

Long thin bent half-round nose precision pliers. PVC protected handles and 2 return springs. Box joint construction.



MSA		Length	Cutting	Kg
11.210	(1)	115 mm	000	0.075
11.206-B	(2)	130 mm	000	0.110

Robust side cutting precision pliers with rounded jaws. PVC protected handles and 2 return springs. Box joint construction.



MSA	Length	Cutting	Kg
11.207	115 mm	000	0.073

Side cutting precision pliers with pointed jaws. PVC protected handles and 2 return springs. Box joint construction.



MSA	Length	Cutting	Kg
11.211	115 mm	000	0.078

Side cutting precision pliers with pointed jaws. PVC protected handles and 2 return springs. Box joint construction.



GERMAN PRECISION PLIERS



MSA		Length	Cutting	Kg
11.208-A	(1)	115 mm	000	0.080
11.212	(2)	115 mm	000	0.080

End cutting precision pliers with straight head. PVC protected handles and 2 return springs. Box joint construction.

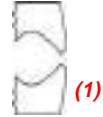

MSA		Length	Cutting	Kg
11.209	(1)	120 mm	000	0.080
11.213	(2)	120 mm	000	0.080

End cutting precision pliers with inclined head. PVC protected handles and 2 return springs. Box joint construction.

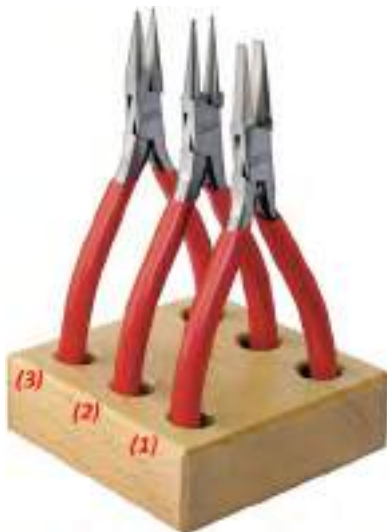

MSA		Kg
11.850		0.291

Assortment of 3 precision pliers with 2 return springs. Box joint construction. Delivered on a wooden stand.

Contents :

MSA	Item	Kg
11.200-A	(1) Flat nose pliers	0.060
11.201-A	(2) Round nose pliers	0.058
11.202-A	(3) Half-round nose pliers	0.062



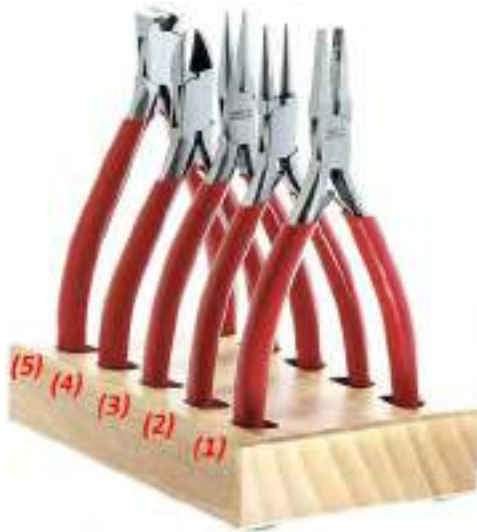

MSA	Kg
11.859	0.540

Assortment of 5 precision pliers with 2 return springs.
 Box joint construction.
 Delivered on a wooden stand.

Contents :

MSA	Item	Kg
11.200-A	(1) Flat nose pliers	0.060
11.201-A	(2) Round nose pliers	0.058
11.202-A	(3) Half-round nose pliers	0.062
11.210	(4) Side cutting pliers, plain cutting	0.075
11.212	(5) End cutting pliers, plain cutting	0.080

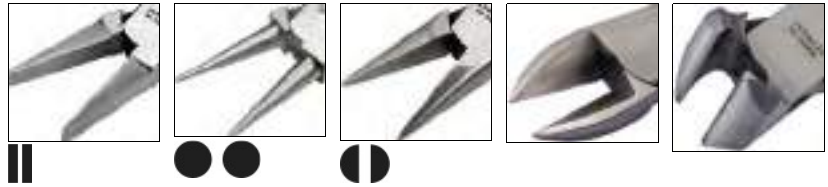

Manufactured with uncompromising Swiss quality, Erem® cutters are designed to be strong, durable, sharp and have the highest precision available.

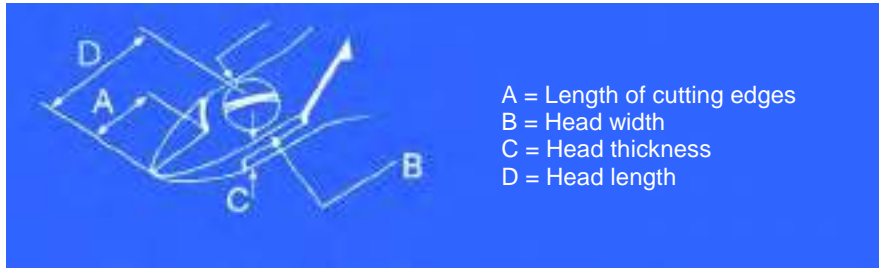

MSA	Length	A	B	C	D	Kg
11.928	110 mm	9 mm	9.80 mm	6 mm	16 mm	0.048

Tip cutters with pointed relieved head.

Maximum cutting capability in mm : medium wire Ø 0.60 / copper wire Ø 0.80.

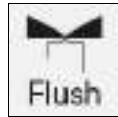

MSA	Length	A	B	C	D	Kg
11.920	(1) 110 mm	9 mm	11 mm	6 mm	19 mm	0.067
11.921	(2) 110 mm	9 mm	11 mm	6 mm	19 mm	0.067

Tip cutters with angled wide, robust head.

Maximum cutting capability in mm : medium wire Ø 1.00 / copper wire Ø 1.60.

Maximum cutting capability in mm : medium wire Ø 0.80 / copper wire Ø 1.30.



MSA	Length	A	B	C	D	Kg
11.925	110 mm	9 mm	9 mm	6 mm	15 mm	0.048

Side cutters with oval head.

Maximum cutting capability in mm : hard wire Ø 0.50 / medium wire Ø 0.80 / copper wire Ø 1.30.



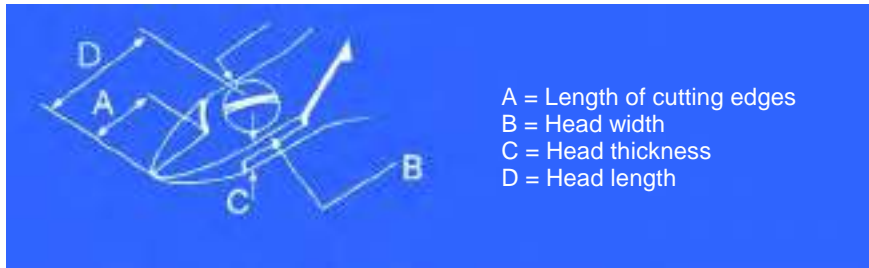

MSA	Length	A	B	C	D	Kg
11.924	120 mm	15 mm	13.50 mm	7.20 mm	21 mm	0.067

Side cutters with oval head.
 Maximum cutting capability in mm : medium wire Ø 1.20 / copper wire Ø 1.80.

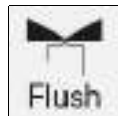

MSA	Length	A	B	C	D	Kg
11.934	110 mm	9 mm	9 mm	6 mm	15 mm	0.048

Side cutters with oval head.
 Maximum cutting capability in mm : medium wire Ø 0.70 / copper wire Ø 1.30.



The LINDSTROM® pliers are considered to be the best in the world. Made with special steel and forged components specially studied. They offer an unequalled cutting capacity and a precision equivalent for all types of wire. Equipped with plastic handles and 2 return springs.

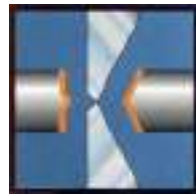

Flush



Ultra-Flush®



Micro-Bevel®



MSA	Model	Kg
11.906	7490	0.048

Precision pliers. Flat and smooth noses made of high performance steel. Specially made box joint with extra long contact surfaces, made possible by a unique manufacturing process. With 2 return springs.

Box joint construction.

Head 20 x 9 mm. Total length 120 mm.



MSA	Model	Kg
11.909	7890	0.060

Precision half-round extra-long nose with polished interior side and 2 return springs.

Box joint construction.

Head 32 x 9 mm. Total length 132 mm.



MSA	Model	Kg
11.910	7893	0.056

Precision half-round nose with 2 return springs.

Box joint construction.

Head 20 x 9 mm. Total length 120 mm.





MSA	Cutting	Model	Copper wire cutting capacity	Kg
11.903	Flush	7191	0.10...1.25 mm	0.044

Precision pliers, side cutting with pointed and three-square head and 2 return springs.
Screw lap joint construction.
Head 9 x 9 mm. Total length 109 mm.



MSA	Cutting	Model	Copper wire cutting capacity	Kg
11.901	Flush	7293	0.35...1.00 mm	0.048
11.900	Flush	7291	0.35...1.25 mm	0.048
11.902	Micro-bevel®	7290	0.35...1.25 mm	0.048

Precision pliers, oblique cutting at 11° with inclined head and 2 return springs.
Box joint construction.
Head 8 x 10.5 mm. Total length 108 mm.



MSA	Cutting	Model	Copper wire cutting capacity	Kg
11.904	000	8162	0.30...1.60 mm	0.088
11.905	Micro-bevel®	8140	0.20...1.25 mm	0.048

Precision pliers. Diagonal cutting with oval head made of high performance oxidized black steel and 2 return springs. Cutting edges hardened by induction.
Screw lap joint construction.
Head 16 x 16 mm. Total length 125 and 110 mm.



MSA	Cutting	Model	Copper wire cutting capacity	Kg
11.908	Micro-bevel®	8146	0.20...1.00 mm	0.046

Precision side cutter with oxidized black and sharp-pointed nose. 2 return springs.
Lap joint construction.
Head 10 x 10 mm. Total length 110 mm.



LINDSTROM® PLIERS

LINDSTROM
PRECISION TOOLS



MSA	Cutting	Model	Copper wire cutting capacity	Kg
11.911	Micro-Bevel®	8160	0.40...2.00 mm	0.088

Precision side cutter with oxidized black and round nose, with 2 return springs.

Lap joint construction.

Head 16 x 16 mm. Total length 125 mm.



LINDSTROM
PRECISION TOOLS



MSA	Cutting	Model	Copper wire cutting capacity	Kg
11.907	Flush	7292	0.35...0.80 mm	0.056

Precision pliers, bent nose towards the interior. With 2 return springs.

Box joint construction.

Head 15 x 9 mm. Total length 115 mm.



Carbon steel pliers specially made for cutting hairsprings.
Plain and impeccable cutting.



MSA	No.	Length	Kg
11.705	17	125 mm	0.076

Carbon steel pliers for cutting hairsprings. Inclined head, anti-skid handles with 2 return springs. Screw lap joint construction.



MSA	No.	Length	Kg
11.706	20	110 mm	0.081

Carbon steel pliers for cutting hairsprings. Straight and pointed head at both ends, anti-skid handles with 2 return springs. Screw lap joint construction.



BAHCO® and KNIPEX® cutting pliers.



MSA	Cutting	Cutting capacity	Kg
11.228	Bevelled	Ø 1.80 mm : piano-wire Ø 5.00 mm : copper wire	0.134

Steel side cutting BAHCO® precision pliers, with large anti-skid handles and 1 return spring. Lap joint construction. Total length 155 mm.



MSA	Cutting	Cutting capacity	Kg
11.229	Bevelled	Ø 1.50 mm : piano-wire Ø 4.00 mm : copper wire	0.134

Heavy duty KNIPEX® end cutter with strong torque. Tempered and polished head and PVC protected handles. Lap joint construction. Total length 140 mm.

SPECIAL PLIERS

Round-nose pliers.

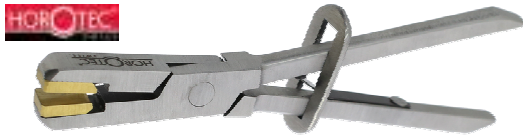

MSA	Length	Kg
11.320	130 mm	?

Round-nose pliers in polished steel, box joint and smooth brass jaws.

Ring cutters.

PRECITEC



MSA	Length	Kg
11.230	160 mm	0.107

Large ring cutting pliers with chromed grooved handle.
Delivered with 1 mounted thin teeth steel circular saw.

Spare part :

MSA	Item	Kg
11.230-A	Circular saw, Ø 21 mm	0.002



PRECITEC



MSA	Length	Kg
11.198	178 mm	0.145

Steel ring cutter with PVC protected handles.
Delivered with 1 mounted thin teeth hardened steel circular saw and 1 key for saw change.

Spare part :

MSA	Item	Kg
11.198-A	Circular saw, Ø 30 mm	0.005



MSA	Length	Kg
11.226	120 mm	0.095

Ring cutter with knurled steel handle.
Delivered with 1 mounted thin teeth hardened steel circular saw and 1 key for saw change.

Spare part :

MSA	Item	Kg
11.226-A	Circular saw, Ø 20 mm	0.001



Revolving pliers for leather holing.



MSA	Length	Kg
11.300	200 mm	0.280

Revolving pliers for leather holing with 6 punchers.

Holing Ø : 2.0 - 2.5 - 3.0 - 3.5 - 4.0 - 4.5 mm.



MSA	Version	Size	Kg
11.310	Complete case	270 x 225 x 80 mm	1.100
11.311	Light case	270 x 225 x 80 mm	0.970

Multiplied pliers for piercing leather straps, delivered in a case.

Composition MSA11.310, complete case :

- MSA11.310-P : 1 multiplied pliers
- MSA11.310-0x : 4 brass supports, centre-to-centre 5, 6, 7 and 8 mm
- MSA11.310-Pxxx : 6 round punches, Ø 1.00, 1.20, 1.40, 1.60, 1.80 and 2.00 mm
- MSA11.310-Gxxx : 18 round guides (3x per diameter) Ø 1.00, 1.20, 1.40, 1.60, 1.80 and 2.00 mm
- MSA11.310-CL : 1 Allen key.

Composition MSA11.311, light case :

- MSA11.310-P : 1 multiplied pliers
- MSA11.310-07 : 1 brass support, centre-to-centre 7 mm
- MSA11.310-P180 : 1 round punch, Ø 1.80 mm
- MSA11.310-G180 : 3 round guides Ø 1.80 mm
- MSA11.310-CL : 1 Allen key.

Holing Ø : 1.00, 1.20, 1.40, 1.60, 1.80 and 2.00 mm.



Spare parts :

MSA	Item	Kg
11.310-05	Brass support, centre-to-centre 5 mm	0.038
11.310-06	(1) Brass support, centre-to-centre 6 mm	0.038
11.310-07	Brass support, centre-to-centre 7 mm	0.038
11.310-08	Brass support, centre-to-centre 8 mm	0.038
11.310-G100	(2) Round guide, Ø 1.00 mm	0.001
11.310-G120	Round guide, Ø 1.20 mm	0.001
11.310-G140	Round guide, Ø 1.40 mm	0.001
11.310-G160	Round guide, Ø 1.60 mm	0.001
11.310-G180	Round guide, Ø 1.80 mm	0.001
11.310-G200	Round guide, Ø 2.00 mm	0.001
11.310-P	Pliers alone, 210 x 110 x 45 mm	0.455
11.310-P100	(3) Round punch, Ø 1.00 mm	0.001
11.310-P120	Round punch, Ø 1.20 mm	0.001
11.310-P140	Round punch, Ø 1.40 mm	0.001
11.310-P160	Round punch, Ø 1.60 mm	0.001
11.310-P180	Round punch, Ø 1.80 mm	0.001
11.310-P200	Round punch, Ø 2.00 mm	0.001

PLIERS ASSORTMENTS

Summary of pliers assortments.

PRECITEC



MSA	Kg
11.803	0.345

Assortment of 3 pliers, with 2 return springs.
Box joint construction.
Delivered on a wooden stand.

Contents :

MSA	Item	Kg
11.801-A	(1) Round nose pliers	0.073
11.802-A	(2) Half-round nose pliers	0.073
11.800-A	(3) Flat nose pliers	0.080

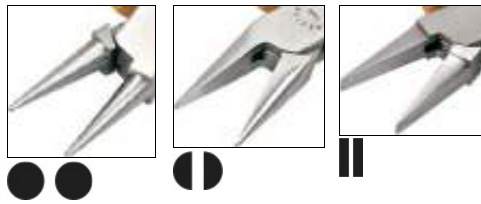

PRECITEC



MSA	Kg
11.804	0.440

Assortment of 3 pliers, without return springs.
Box joint construction.
Delivered on a wooden stand.

Contents :

MSA	Item	Kg
11.802-B	(1) Half-round nose pliers	0.095
11.801-B	(2) Round nose pliers	0.090
11.800-B	(3) Flat nose pliers	0.100

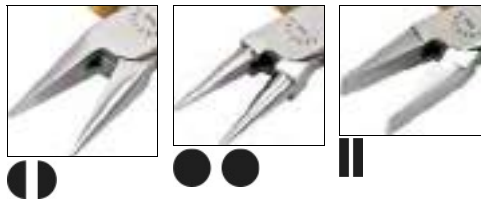

PRECITEC



MSA	Kg
11.813	0.415

Assortment of 3 pliers, without return springs.
Box joint construction.
Delivered on a wooden stand.

Contents :

MSA	Item	Kg
11.800-B	(1) Flat nose pliers	0.100
11.812	(2) Pliers for removing bracelet links	0.095
11.802-B	(3) Half-round nose pliers	0.095

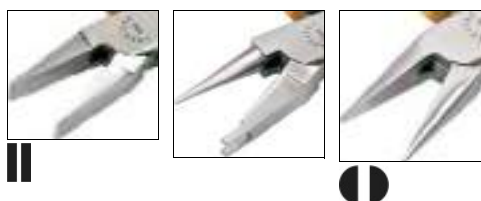



MSA	Kg
11.817	0.445

Assortment of 3 pliers.
Box joint construction.
Delivered on a wooden stand.

Contents :

MSA	Item	Kg
11.812	(1) Pliers for removing bracelet links	0.095
11.809	(2) Flat nose pliers, serrated anti-skid interior	0.097
11.816	(3) Leather straps hole punching pliers	0.150

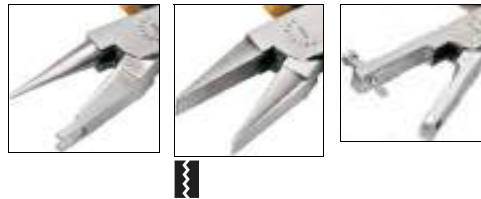

MSA	Kg
11.818	0.450

Assortment of 3 pliers.
Box joint construction.
Delivered on a wooden stand.

Contents :

MSA	Item	Kg
11.827	(1) End cutting pliers, bevelled cutting	0.102
11.801-B	(2) Round nose pliers	0.090
11.809	(3) Flat nose pliers, serrated anti-skid interior	0.097

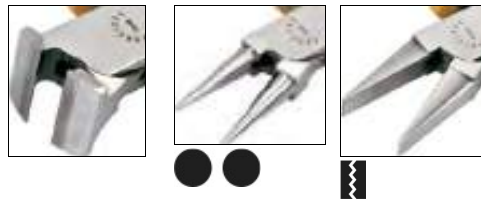

MSA	Kg
11.831	0.408

Assortment of 3 pliers, with 2 return springs.
Delivered on a wooden stand.

Contents :

MSA	Item	Kg
11.829	(1) Side cutting pliers, plain cutting	0.090
11.828	(2) Side cutting pliers, bevelled cutting	0.110
11.827	(3) End cutting pliers, bevelled cutting	0.102



PLIERS ASSORTMENTS

PRECITEC
SWISS



MSA	Kg
11.832	0.606

Assortment of 5 pliers, with 2 return springs.
Delivered on a wooden stand.

Contents :

MSA	Item	Kg
11.820	(1) End cutting pliers, bevelled cutting	0.146
11.810	(2) Side cutting pliers, bevelled cutting	0.140
11.802-A	(3) Half-round nose pliers	0.073
11.801-A	(4) Round nose pliers	0.073
11.800-A	(5) Flat nose pliers	0.080

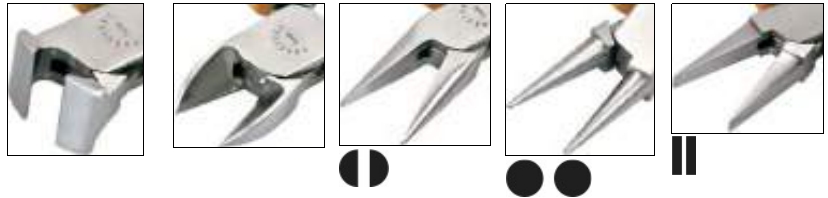

PRECITEC
SWISS



MSA	Kg
11.840	0.395

Assortment of 3 pliers, without return springs.
Delivered on a wooden stand.

Contents :

MSA	Item	Kg
11.833-B	(1) Flat nose pliers	0.092
11.834-B	(2) Round nose pliers	0.097
11.835-B	(3) Half-round nose pliers	0.097

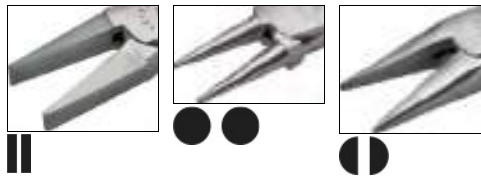

PRECITEC
SWISS



MSA	Kg
11.856	0.645

Assortment of 5 pliers with anti-skid handles.
Delivered on a wooden stand.

Contents :

MSA	Item	Kg
11.852	(1) Round nose pliers	0.090
11.853	(2) Half-round nose pliers	0.085
11.851	(3) Flat nose pliers	0.087
11.854	(4) End cutting pliers	0.108
11.855	(5) Side cutting pliers	0.094





MSA	Kg
11.857	0.406

Assortment of 3 pliers with anti-skid handles.
Delivered on a wooden stand.

Contents :

MSA	Item	Kg
11.852	(1) Round nose pliers	0.090
11.853	(2) Half-round nose pliers	0.085
11.851	(3) Flat nose pliers	0.087

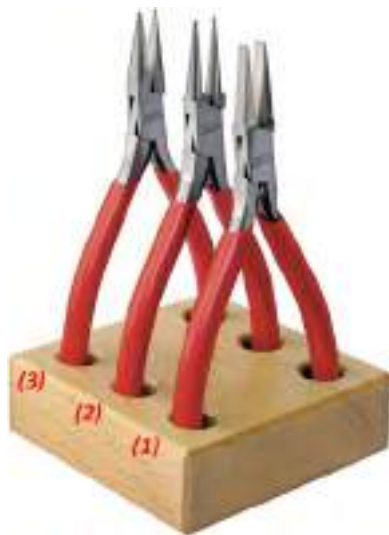
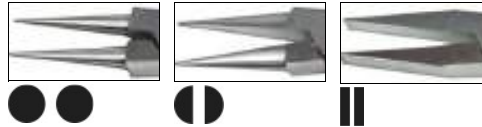

MSA	Kg
11.850	0.291

Assortment of 3 precision pliers with 2 return springs.
Box joint construction.
Delivered on a wooden stand.

Contents :

MSA	Item	Kg
11.200-A	(1) Flat nose pliers	0.060
11.201-A	(2) Round nose pliers	0.058
11.202-A	(3) Half-round nose pliers	0.062

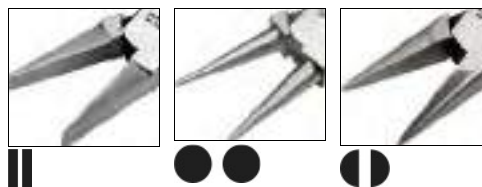

MSA	Kg
11.859	0.540

Assortment of 5 precisions pliers with 2 return springs.
Box joint construction.
Delivered on a wooden stand.

Contents :

MSA	Item	Kg
11.200-A	(1) Flat nose pliers	0.060
11.201-A	(2) Round nose pliers	0.058
11.202-A	(3) Half-round nose pliers	0.062
11.210	(4) Side cutting pliers, plain cutting	0.075
11.212	(5) End cutting pliers, plain cutting	0.080

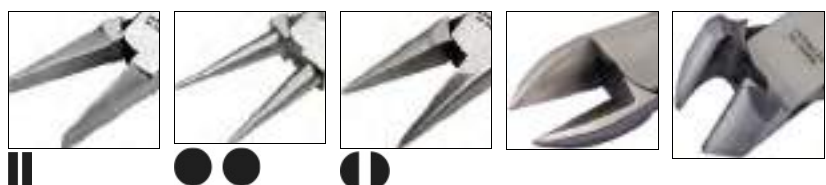

12



HOROTEC® TWEEZERS FOR WATCHMAKING

12 - 2

HOROTEC® ALUMINIUM TWEEZERS

12 - 13

HOROSWISS® TWEEZERS

12 - 16

PRECITEC® TWEEZERS

12 - 18

VARIOUS TWEEZERS

12 - 20

HOROTEC® tweezers are made for the most demanding watchmakers. The tips are perfectly aligned and the inside is hand polished to assure the best possible finishing. The steels and other alloys are carefully selected to assure top quality.



MSA12.382



MSA12.385



MSA12.386

MSA	Tweezers	Material	Packaging size	Kg
12.381	1 - 3 - 5 - 7	Stainless steel	90 x 165 x 27 mm	0.148
12.382	1 - 3 - 5 - 7	Antimagnetic steel 904L	90 x 165 x 27 mm	0.148
12.383	2 - 2A - 5 - 51	Antimagnetic steel 904L, sand blasted body and mirror polished tips	90 x 165 x 27 mm	0.142
12.384	3 - 5 - 7 - 27	Antimagnetic steel 904L, sand blasted body and mirror polished tips	90 x 165 x 27 mm	0.144
12.385	2 - 3	Stainless steel	90 x 165 x 27 mm	0.149
	2 - 3	Antimagnetic steel 904L, sand blasted body and mirror polished tips		
12.386	1 - 3 - 4 - 5	Antimagnetic steel 904L	90 x 165 x 27 mm	0.147
12.387	1 - 2 - 3 - 5	Stainless steel	90 x 165 x 27 mm	0.151
12.388	1 - 2 - 3 - 5	Antimagnetic steel 904L	90 x 165 x 27 mm	0.151
12.389	00	Carbon steel	90 x 165 x 27 mm	0.152
	1 - 3 - F1	Antimagnetic steel 904L, sand blasted body and mirror polished tips		
12.390	2 - 3 - 4 - 5	Antimagnetic steel 904L, sand blasted body and mirror polished tips	90 x 165 x 27 mm	0.142

Assortment of tweezers.
Delivered in a wooden box.



MSA12.300-x Hard carbon steel
 MSA12.301-x Stainless steel
 MSA12.302-x Antimagnetic steel 904L
 MSA12.303-x Brass
 MSA12.304-x 100% antimagnetic nickel
 MSA12.305-x Beryllium copper
 MSA12.306-x Bronze

**STANDARD POLISHED
 BODY AND TIPS !**



00

MSA	Material	Length	Kg
12.300-00	Carbon steel	120 mm	0.022
12.301-00	Stainless steel	120 mm	0.022
12.302-00	Antimagnetic steel 904L	120 mm	0.022

Thick tweezers with flat tips, Geneva shape.



0

MSA	Material	Length	Kg
12.300-0	Carbon steel	120 mm	0.018
12.301-0	Stainless steel	120 mm	0.018
12.302-0	Antimagnetic steel 904L	120 mm	0.018

Fine tweezers, Geneva shape.



0C

MSA	Material	Length	Kg
12.302-0C	Antimagnetic steel 904L	90 mm	0.008

Fine and short tweezers for hairsprings.



1

MSA	Material	Length	Kg
12.300-1	Carbon steel	120 mm	0.016
12.301-1	Stainless steel	120 mm	0.016
12.302-1	Antimagnetic steel 904L	120 mm	0.016
12.305-1	Beryllium copper	120 mm	0.016

Strong tweezers.



2

MSA	Material	Length	Kg
12.300-2	Carbon steel	120 mm	0.018
12.301-2	Stainless steel	120 mm	0.018
12.302-2	Antimagnetic steel 904L	120 mm	0.018

Strong tweezers with fine and flat tips.



2A

MSA	Material	Length	Kg
12.302-2A	Antimagnetic steel 904L	120 mm	0.014

Tweezers with large and round tips for straightening hands.

HOROTEC® TWEEZERS FOR WATCHMAKING



3

MSA	Material	Length	Kg
12.300-3	Carbon steel	120 mm	0.014
12.301-3	Stainless steel	120 mm	0.014
12.302-3	Antimagnetic steel 904L	120 mm	0.014
12.305-3	Beryllium copper	120 mm	0.014

Fine tweezers for hairsprings.



3C

MSA	Material	Length	Kg
12.300-3C	Carbon steel	110 mm	0.013
12.301-3C	Stainless steel	110 mm	0.013
12.302-3C	Antimagnetic steel 904L	110 mm	0.013

Fine and short tweezers for hairsprings.



4

MSA	Material	Length	Kg
12.300-4	Carbon steel	110 mm	0.014
12.301-4	Stainless steel	110 mm	0.014
12.302-4	Antimagnetic steel 904L	110 mm	0.014
12.303-4	Brass	110 mm	0.014

Tweezers with long and fine tips for hairsprings.



5

MSA	Material	Length	Kg
12.300-5	Carbon steel	110 mm	0.013
12.301-5	Stainless steel	110 mm	0.013
12.302-5	Antimagnetic steel 904L	110 mm	0.013

Short and extra-fine tweezers for hairsprings.



5 COBASTEEL

MSA	Material	Length	Kg
12.308-5	Cobasteel	110 mm	0.015

Short and extra-fine cobasteel tweezers for hairsprings.
The new cobasteel alloy offers an exceptional strength and durability.

- 100% antimagnetic
- Corrosion resistant
- Tip hardness 63/64 HRC.



5-SP

MSA	Material	Length	Kg
12.302-5SP	Antimagnetic steel 904L	105 mm	0.008

Short and extra-fine tweezers for hairsprings.



6

MSA	Material	Length	Kg
12.300-6	Carbon steel	115 mm	0.018
12.301-6	Stainless steel	115 mm	0.018
12.302-6	Antimagnetic steel 904L	115 mm	0.018

Tweezers hook shape and fine tips.



7

MSA	Material	Length	Kg
12.301-7	Stainless steel	115 mm	0.015
12.302-7	Antimagnetic steel 904L	115 mm	0.015

Curved and extra-fine tweezers for hairsprings.



11

MSA	Material	Length	Kg
12.304-11	100% antimagnetic nickel	120 mm	0.019

Tweezers with strong tips.



12

MSA	Material	Length	Kg
12.304-12	100% antimagnetic nickel	120 mm	0.019

Tweezers with fine tips.



14

MSA	Material	Length	Kg
12.300-14	Carbon steel	110 mm	0.030

Simple tweezers for removing and holding hands.



14A

MSA	Material	Length	Kg
12.300-14A	Carbon steel	115 mm	0.021

Tweezers with sliding locker for removing and holding hands.



15

MSA	Material	Length	Kg
12.300-15	Carbon steel	105 mm	0.014

Tweezers for marking hairsprings.



15A

MSA	Material	Length	Kg
12.300-15A	Carbon steel	115 mm	0.035

Strong tweezers for cutting hairsprings.



15AF



MSA	Material	Length	Kg
12.300-15AF	Carbon steel	115 mm	0.030

Strong tweezers for cutting hairsprings.



27

MSA	Material	Length	Kg
12.302-27	Antimagnetic steel 904L	135 mm	0.017

Strong and pointed tweezers for stones.

HOROTEC® TWEEZERS FOR WATCHMAKING



AA

MSA	Material	Length	Kg
12.301-AA	Stainless steel	125 mm	0.020
12.303-AA	Brass	125 mm	0.020

Strong and elegant tweezers for ordinary use.



AM

MSA	Material	Length	Kg
12.303-AM	Antimagnetic brass	130 mm	0.022

Tweezers for hairsprings, Parisian shape.



B1

MSA	Material	Length	Kg
12.303-B1	Brass	130 mm	0.019

Simple tweezers with fine tips.



B5

MSA	Material	Length	Kg
12.300-B5	Carbon steel	125 mm	0.019
12.301-B5	Stainless steel	125 mm	0.019
12.303-B5	Brass	125 mm	0.019
12.304-B5	100% antimagnetic nickel	125 mm	0.019
12.306-B5	Bronze	125 mm	0.019
12.307-B5	Gilt brass	125 mm	0.022

Strong and pointed tweezers.



D

MSA	Material	Length	Kg
12.300-D	Carbon steel	95 mm	0.026

Tweezers for cutting and removing rollers, pivots and pinions.



F

MSA	Material	Length	Kg
12.300-F	Carbon steel	115 mm	0.016
12.301-F	Stainless steel	115 mm	0.016
12.302-F	Antimagnetic steel 904L	115 mm	0.016

Tweezers with flat tips for straightening hands.



MM

MSA	Material	Length	Kg
12.300-MM	Carbon steel	125 mm	0.019
12.302-MM	Antimagnetic steel 904L	125 mm	0.019
12.303-MM	Brass	125 mm	0.019

Tweezers for hairsprings, Parisian shape.



P

MSA	Material	Length	Kg
12.300-P	Carbon steel	120 mm	0.014
12.301-P	Stainless steel	120 mm	0.014
12.302-P	Antimagnetic steel 904L	120 mm	0.014

Simple tweezers with strong tips.



S

MSA	Material	Length	Kg
12.301-S	Stainless steel	120 mm	0.015
12.302-S	Antimagnetic steel 904L	120 mm	0.015

Simple tweezers with fine tips.



S5

MSA	Material	Length	Kg
12.303-S5	Brass	130 mm	0.022
12.304-S5	100% antimagnetic nickel	130 mm	0.022
12.306-S5	Bronze	130 mm	0.019

Simple tweezers with fine tips.



S5C

MSA	Material	Length	Kg
12.303-S5C	Brass	135 mm	0.021

Bent tweezers with fine tips.



SS

MSA	Material	Length	Kg
12.302-SS	Antimagnetic steel 904L	140 mm	0.015

Long and narrow tweezers with fine tips.



**HIGH QUALITY FINISHING.
SAND BLASTED BODY AND MIRROR POLISHED TIPS !**



1

MSA	Material	Length	Kg
12.312-1	Antimagnetic steel 904L	120 mm	0.013

Strong tweezers, sand blasted body and mirror polished tips.



2

MSA	Material	Length	Kg
12.312-2	Antimagnetic steel 904L	120 mm	0.014

Strong tweezers with fine and flat tips, sand blasted body and mirror polished tips.



2A

MSA	Material	Length	Kg
12.312-2A	Antimagnetic steel 904L	120 mm	0.014

Large tweezers with round tips for straightening hands, sand blasted body and mirror polished tips.



3

MSA	Material	Length	Kg
12.312-3	Antimagnetic steel 904L	120 mm	0.013

Fine tweezers for hairsprings, sand blasted body and mirror polished tips.



4

MSA	Material	Length	Kg
12.312-4	Antimagnetic steel 904L	110 mm	0.013

Tweezers with long and fine tips for hairsprings, sand blasted body and mirror polished tips.



5

MSA	Material	Length	Kg
12.312-5	Antimagnetic steel 904L	110 mm	0.012

Extra-fine tweezers for hairsprings, sand blasted body and mirror polished tips.



7

MSA	Material	Length	Kg
12.312-7	Antimagnetic steel 904L	115 mm	0.013

Curved and extra-fine tweezers for hairsprings, sand blasted body and mirror polished tips.



27

MSA	Material	Length	Kg
12.312-27	Antimagnetic steel 904L	135 mm	0.016

Strong and pointed tweezers for stones, sand blasted body and mirror polished tips.



51

MSA	Material	Length	Kg
12.312-51	Antimagnetic steel 904L	115 mm	0.012

Bent and extra-fine tweezers for hairsprings, sand blasted body and mirror polished tips.



F

MSA	Material	Length	Kg
12.312-F	Antimagnetic steel 904L	120 mm	0.015

Tweezers with standard flat tips for straightening hands, sand blasted body and mirror polished tips.



F1

MSA	Material	Length	Kg
12.312-F1	Antimagnetic steel 904L	120 mm	0.016

Tweezers with fine round tips for straightening hands, sand blasted body and mirror polished tips.



STANDARD POLISHED BODY AND MIRROR POLISHED TIPS !



1

MSA	Material	Length	Kg
12.302-1/1	Antimagnetic steel 904L	120 mm	0.016

Strong tweezers with mirror polished tips.



2

MSA	Material	Length	Kg
12.302-2/1	Antimagnetic steel 904L	120 mm	0.015

Strong tweezers with fine and flat mirror polished tips.



2A

MSA	Material	Length	Kg
12.302-2A/1	Antimagnetic steel 904L	120 mm	0.016

Large tweezers with round mirror polished tips, for straightening hands.



3

MSA	Material	Length	Kg
12.302-3/1	Antimagnetic steel 904L	120 mm	0.014

Fine tweezers for hairsprings, mirror polished tips.



5

MSA	Material	Length	Kg
12.302-5/1	Antimagnetic steel 904L	110 mm	0.013

Short and extra-fine tweezers for hairsprings, mirror polished tips.



7

MSA	Material	Length	Kg
12.302-7/1	Antimagnetic steel 904L	115 mm	0.013

Curved and extra-fine tweezers with mirror polished tips.



51

MSA	Material	Length	Kg
12.302-51/1	Antimagnetic steel 904L	115 mm	0.012

Tweezers for hairsprings with bent and extra-fine mirror polished tips.



F1

MSA	Material	Length	Kg
12.301-F1	Stainless steel	115 mm	0.017
12.302-F1	Antimagnetic steel 904L	115 mm	0.017

Tweezers with round mirror polished tips, for straightening hands.

HOROTEC® tweezers for special works.



2A-H

MSA	Material	Length	Kg
12.312-2A-H	Antimagnetic steel 904L	118 mm	0.016

Stacked tweezers for hands fitting, mirror finishing.



LG

MSA	Material	Ø tightening	Kg
12.301-LG1	Stainless steel	2.00 mm	0.016

Tweezers with round tips for tubes and pins.



LP

MSA	Material	Ø tightening	Kg
12.301-LP2	Stainless steel	0.80 mm	0.016
12.301-LP1	Stainless steel	1.60 mm	0.016

Tweezers with round tips for tubes and pins.

HOROTEC® tweezers for curving hairsprings.



10B

MSA	Material	Length	Kg
12.300-10B	Carbon steel	115 mm	0.015

Tweezers for curving hairsprings.

100% antimagnetic nickel HOROTEC® special tweezers with red vulcanized fibre tips.



MSA	Material	Length	Kg
12.150	100% antimagnetic nickel	125 mm	0.020

Tweezers with red vulcanized fibre tips, extra-fine tips 0.50 mm.



MSA	Material	Length	Kg
12.727	100% antimagnetic nickel	125 mm	0.020

Tweezers with red vulcanized fibre tips, fine tips.



MSA	Material	Length	Kg
12.710	100% antimagnetic nickel	125 mm	0.020

Tweezers with red vulcanized fibre tips, medium tips.



MSA	Material	Length	Kg
12.726	100% antimagnetic nickel	125 mm	0.020

Tweezers with red vulcanized fibre tips, large tips.



MSA	Material	Length	Kg
12.729	100% antimagnetic nickel	125 mm	0.020

Tweezers with red vulcanized fibre and felt tips for oiling mainsprings, large tips.

HOROTEC® tweezers with ceramic tips.



MSA	Material	Length	Kg
12.151	Nickel non magnetic	130 mm	0.026

Tweezers with ceramic tips 1.30 x 0.50 mm. These tweezers are resistant to acids and high temperatures without transmitting heat.

HOROTEC® aluminium tweezers with interchangeable hard tips made of black carbonic-fibre or white Delrin®. Used for handling delicate pieces without marking them. They are so light that they allow you to prolong the work without any tiredness.

ANTIMAGNETIC AND ULTRA LIGHT, 10 g !



MSA	Kg
12.728	0.001

Pair of clips for replacement tips. A patented clip system allows a fast and accurate change of the used tips.



MSA	Material	Length	Kg
12.711	Aluminium	123 mm	0.010

Tweezers with large and square black carbon fibre hard tips.

Spare part :

MSA	Item	Kg
12.711-A	Pair of tips for MSA12.711	0.002



MSA	Material	Length	Kg
12.712	Aluminium	130 mm	0.010

Tweezers with large and round black carbon fibre hard tips.

Spare part :

MSA	Item	Kg
12.712-A	Pair of tips for MSA12.712	0.002



MSA	Material	Length	Kg
12.713	Aluminium	130 mm	0.010

Tweezers with fine black carbon fibre hard tips.

Spare part :

MSA	Item	Kg
12.713-A	Pair of tips for MSA12.713	0.002



MSA	Material	Length	Kg
12.714	Aluminium	130 mm	0.010

Tweezers with very fine black carbon fibre hard tips.

Spare part :

MSA	Item	Kg
12.714-A	Pair of tips for MSA12.714	0.002



MSA	Material	Length	Kg
12.715	Aluminium	120 mm	0.010

Tweezers with curved and fine black carbon fibre hard tips.

Spare part :

MSA	Item	Kg
12.715-A	Pair of tips for MSA12.715	0.002

HOROTEC® ALUMINIUM TWEEZERS



MSA	Material	Length	Kg
12.721	Aluminium	123 mm	0.010

Tweezers with large and square white Delrin® soft tips.

Spare part :

MSA	Item	Kg
12.721-A	Pair of tips for MSA12.721	0.002



MSA	Length	Kg
12.722	130 mm	0.010

Tweezers with large and round white Delrin® soft tips.

Spare part :

MSA	Item	Kg
12.722-A	Pair of tips for MSA12.722	0.002



MSA	Material	Length	Kg
12.723	Aluminium	130 mm	0.010

Tweezers with fine white Delrin® soft tips.

Spare part :

MSA	Item	Kg
12.723-A	Pair of tips for MSA12.723	0.002



MSA	Material	Length	Kg
12.724	Aluminium	130 mm	0.010

Tweezers with very fine white Delrin® soft tips.

Spare part :

MSA	Item	Kg
12.724-A	Pair of tips for MSA12.724	0.002



MSA	Material	Length	Kg
12.725	Aluminium	120 mm	0.010

Tweezers with curved and fine white Delrin® soft tips.

Spare part :

MSA	Item	Kg
12.725-A	Pair of tips for MSA12.725	0.002



MSA	Material	Length	Kg
12.761	Aluminium	123 mm	0.010

Tweezers with large and square PEEK tips.

Spare part :

MSA	Item	Kg
12.761-A	Pair of tips for MSA12.761	0.002



MSA	Material	Length	Kg
12.762	Aluminium	123 mm	0.010

Tweezers with large and round KEEP tips.

Spare part :

MSA	Item	Kg
12.762-A	Pair of tips for MSA12.762	0.002



MSA	Material	Length	Kg
12.763	Aluminium	123 mm	0.010

Tweezers with fine PEEK tips.

Spare part :

MSA	Item	Kg
12.763-A	Pair of tips for MSA12.763	0.002



MSA	Material	Length	Kg
12.764	Aluminium	123 mm	0.010

Tweezers with very fine PEEK tips.

Spare part :

MSA	Item	Kg
12.764-A	Pair of tips for MSA12.764	0.002



MSA	Material	Length	Kg
12.765	Aluminium	123 mm	0.010

Tweezers with curved and fine PEEK tips.

Spare part :

MSA	Item	Kg
12.765-A	Pair of tips for MSA12.765	0.002

Watch making HOROSWISS® tweezers are specially made in standard polish and at competitive prices. The tips are perfectly aligned with a neat finish. Steels and other alloys are carefully selected to ensure a very good Swiss Made quality. For daily jobs requiring precise and fine tweezers.



MSA12.811-x Stainless steel
MSA12.812-x Antimagnetic steel 316L
MSA12.813-x Brass



00

MSA	Material	Length	Kg
12.811-00	Stainless steel	120 mm	0.022
12.812-00	Antimagnetic steel 316L	120 mm	0.022

Thick tweezers with flat tips, Geneva shape.



0

MSA	Material	Length	Kg
12.811-0	Stainless steel	120 mm	0.015
12.812-0	Antimagnetic steel 316L	120 mm	0.015

Fine tweezers, Geneva shape.



1

MSA	Material	Length	Kg
12.811-1	Stainless steel	120 mm	0.015
12.812-1	Antimagnetic steel 316L	120 mm	0.015

Strong tweezers.



2

MSA	Material	Length	Kg
12.811-2	Stainless steel	120 mm	0.016
12.812-2	Antimagnetic steel 316L	120 mm	0.014

Strong tweezers with fine and flat tips.



3

MSA	Material	Length	Kg
12.812-3	Antimagnetic steel 316L	120 mm	0.015

Fine tweezers for hairsprings.



3C

MSA	Material	Length	Kg
12.812-3C	Antimagnetic steel 316L	110 mm	0.013

Fine tweezers for hairsprings.



4

MSA	Material	Length	Kg
12.812-4	Antimagnetic steel 316L	110 mm	0.013

Tweezers with long and fine tips for hairsprings.



5

MSA	Material	Length	Kg
12.812-5	Antimagnetic steel 316L	110 mm	0.014

Short and extra-fine tweezers for hairsprings.



AA

MSA	Material	Length	Kg
12.811-AA	Stainless steel	125 mm	0.017
12.812-AA	Antimagnetic steel 316L	125 mm	0.017
12.813-AA	Brass	125 mm	0.021

Strong and elegant tweezers for ordinary use.



B5

MSA	Material	Length	Kg
12.812-B5	Antimagnetic steel 316L	128 mm	0.019

Strong tweezers with very hard tips.



MM

MSA	Material	Length	Kg
12.813-MM	Brass	120 mm	0.023

Tweezers for hairsprings.

PRECITEC® tweezers. For occasional work requiring tweezers at a very competitive price.



MSA12.901-x Stainless steel
 MSA12.902-x 100% antimagnetic steel
 MSA12.903-x Brass



00

MSA	Material	Length	Kg
12.901-00	Stainless steel	115 mm	0.021

Thick tweezers with flat tips, Geneva shape.



0

MSA	Material	Length	Kg
12.901-0	Stainless steel	115 mm	0.018

Fine tweezers, Geneva shape.



1

MSA	Material	Length	Kg
12.901-1	Stainless steel	120 mm	0.019
12.902-1	100% antimagnetic steel	120 mm	0.019

Strong tweezers.



2

MSA	Material	Length	Kg
12.901-2	Stainless steel	120 mm	0.020
12.902-2	100% antimagnetic steel	120 mm	0.020

Strong tweezers with fine and flat tips.



3

MSA	Material	Length	Kg
12.901-3	Stainless steel	120 mm	0.020
12.902-3	100% antimagnetic steel	120 mm	0.022

Fine tweezers for hairsprings.



3C

MSA	Material	Length	Kg
12.901-3C	Stainless steel	110 mm	0.014
12.902-3C	100% antimagnetic steel	110 mm	0.016

Fine tweezers for hairsprings.



4

MSA	Material	Length	Kg
12.901-4	Stainless steel	110 mm	0.018
12.902-4	100% antimagnetic steel	110 mm	0.020

Tweezers with long and fine tips for hairsprings.



5

MSA	Material	Length	Kg
12.901-5	Stainless steel	110 mm	0.016
12.902-5	100% antimagnetic steel	110 mm	0.020

Extra-fine tweezers for hairsprings.



6

MSA	Material	Length	Kg
12.901-6	Stainless steel	115 mm	0.023
12.902-6	100% antimagnetic steel	115 mm	0.022

Tweezers hook shape and fine tips.



7

MSA	Material	Length	Kg
12.901-7	Stainless steel	120 mm	0.020
12.902-7	100% antimagnetic steel	120 mm	0.022

Curved and extra-fine tweezers for hairsprings.



AA

MSA	Material	Length	Kg
12.901-AA	Stainless steel	125 mm	0.022
12.902-AA	100% antimagnetic steel	125 mm	0.024
12.903-AA	Brass	125 mm	0.022

Strong and elegant tweezers, for ordinary use.



F

MSA	Material	Length	Kg
12.901-F	Stainless steel	115 mm	0.017
12.902-F	100% antimagnetic steel	115 mm	0.019

Tweezers with flat tips for straightening hands.



MM

MSA	Material	Length	Kg
12.902-MM	100% antimagnetic steel	125 mm	0.019
12.903-MM	Brass	125 mm	0.023

Tweezers for assembling.



SS

MSA	Material	Length	Kg
12.901-SS	Stainless steel	135 mm	0.019
12.902-SS	100% antimagnetic steel	135 mm	0.019

Simple tweezers.

Storage support.



MSA	Size	Kg
12.398	145 x 150 x 120 mm	0.278

Storage support in solid beech for 12 tweezers. Useful for storing the tweezers in the best conditions.

VARIOUS TWEEZERS



MSA	Model	Length	Kg
12.651-A	3 claws	125 mm	0.016
12.651-C	3 claws (economic)	125 mm	0.016

Nickel-plated tweezers for stones, with return spring.



MSA	Model	Length	Kg
12.662	P35	120 mm	0.005

SIPEL® tweezers in synthetic material, tips width 3.20 mm.



MSA	Material	Length	Kg
12.910	Stainless steel	208 mm	0.049

Stainless steel tweezers with sheathed tips for handling parts under steam jet of ELMASTEAM.



See chapter **PERF.**



MSA	Size	Kg
12.649	Ø 12.5 x 150 mm	0.040

Kit Vacuum PEN-VAC Original ESD SAFE with 6 silicone probes + cups, high temperature resistant (230° C). Aluminium body pen with clip. Ideal for picking up flat and very fragile parts up to 200 grams (dials, main plate, etc.).

Contents :

MSA	Item	Kg
12.649-A	Pen-Vac body	0.030
12.649-B (1)	Bent probe, Ø 9.53 mm	0.001
12.649-C (2)	Straight probe, Ø 9.53 mm	0.001
12.649-D (1)	Bent probe, Ø 6.35 mm	0.001
12.649-E (2)	Straight probe, Ø 6.35 mm	0.001
12.649-F (1)	Bent probe, Ø 3.18 mm	0.001
12.649-G (2)	Straight probe, Ø 3.18 mm	0.001
12.649-H (3)	Cup, Ø 9.53 mm	0.001
12.649-J (3)	Cup, Ø 6.35 mm	0.001
12.649-K (3)	Cup, Ø 3.18 mm	0.001



13



UNIVERSAL CORRECTING PRESS

13 - 2

JEWELLING PRESSES

13 - 3

PRESSES FOR RIVETING AND MILLING

13 - 11

STAKING TOOL FOR MILL

13 - 16

INCABLOC® / KIF®

13 - 17

UNIVERSAL CORRECTING PRESS

Universal correcting press.

HOROTEC



MSA	Kg
13.010	1.240

Universal correcting press, facilitates the work of milling, drilling, tapping, deburring, chamfering, reaming, etc.
Wide range of tightening chucks P 4.5 type to be mounted on the broach, fine adjustment of the working height.
Large stainless steel work plate and dies adapter.
Compatible with all HOROTEC® screw-on dies.

Contents :

- 1 press
- 1 tip 1° angle MSA13.010-01
- 1 tip 2° angle MSA13.010-02
- 1 tightening chuck P 4.5 type Ø 3 mm MSA03.875-300
- 1 dies adapter MSA13.010-AD
- 1 ring with knurled knob MSA13.010-BA
- 1 broach for tightening chucks P 4.5 type MSA13.010-BR
- 1 Allen key MSA13.010-CL
- 1 stainless steel table Ø 60 mm MSA13.010-TA.

Spare parts :

MSA	Item	Kg
13.010-01	Tip 1° angle	0.002
13.010-02	Tip 2° angle	0.002
13.010-AD	Dies adapter	0.010
13.010-BA	Ring with knurled knob	0.005
13.010-BR	Broach for tightening chucks P 4.5 type	0.020
13.010-CL	Allen key	0.001
13.010-TA	Stainless steel table Ø 60 mm	0.075

Optional tightening chucks for MSA13.010 (other Ø on request).

HOROTEC



Ø 4.50 mm

MSA	Ø	Kg
03.875-080	0.80 mm	0.002
03.875-100	1.00 mm	0.002
03.875-150	1.50 mm	0.002
03.875-160	1.60 mm	0.002
03.875-200	2.00 mm	0.002
03.875-235	2.35 mm	0.002
03.875-250	2.50 mm	0.002
03.875-300	3.00 mm	0.002
03.875-400	4.00 mm	0.002

Tightening chuck 4.5 type.



MSA	Kg
13.010-KIT	0.096

Kit for dial feet.

Contents :

- 1x MSA22.558-270 : hard metal end mill , L25 mm, shank Ø 3.00, cutting Ø 2.70 mm
- 1x MSA17.102-B : simple oiler Ø 5 mm, blue, medium needle, L70 mm
- 1x MSA26.587-020 : instant adhesive LOCTITE 435, 20 g
- 1x MSA99.153 : assortment of adhesive dial feet, L3 mm, 60 pieces.

Jewelling presses.



MSA	Ø broach reaming	Ø base reaming	Kg
13.100	3 mm	4 mm	0.600
13.100-4	4 mm	4 mm	0.600

Jewelling press with micrometric screw for rectifying endshakes.

- Opening : 25 mm
- Total height : 120 mm
- Base : 80 x 45 mm
- Table : Ø 20 mm
- Micrometric screw pitch = 1.00 mm / 50 divisions (1 division = 0.02 mm).

Spare part :

MSA	Item
13.101-T	Table Ø 40 mm



MSA	Ø broach reaming	Ø base reaming	Kg
13.102-3	3 mm	4 mm	0.600
13.102-4	4 mm	4 mm	0.600

Special jewelling press with micrometric screw (FINE PITCH) for rectifying endshakes.

- Opening : 25 mm
- Total height : 120 mm
- Base : 80 x 45 mm
- Table : Ø 20 mm
- Micrometric screw pitch = 0.50 mm / 50 divisions (1 division = 0.01 mm).

Spare part :

MSA	Item
13.101-T	Table Ø 40 mm



MSA	Ø broach reaming	Ø base reaming	Kg
13.101	3 mm	4 mm	1.130
13.101-4	4 mm	4 mm	1.130

Jewelling press with lever and micrometric screw for rectifying endshakes, graduation 0.02 mm.

- Opening : 30 mm
- Total height : 125 mm
- Base : 90 x 50 mm
- Table : Ø 23 mm.

Spare parts :

MSA	Item
13.101-C	Broach Ø 3 mm, length 73 mm
13.101-A	Broach Ø 4 mm, length 73 mm
13.101-B	Lever
13.101-T	Table Ø 40 mm



MSA	Ø broach reaming	Ø base reaming	Kg
13.104	6 mm	14 mm	3.260
13.104-12	6 mm	12 mm	3.260

Large model jewelling press with lever and micrometric screw for rectifying endshakes, graduation 0.02 mm.

- Maximum distance between the table and the broach : 50 mm
- Opening : 35 mm
- Total height : 200 mm
- Base length : 140 mm
- Table : Ø 35 mm.

Pushers and stakes for jewellery presses.



ASSORTMENT

MSA	Use	Kg
13.110	With broach Ø 3 mm	0.039
13.110-4	With broach Ø 4 mm	0.039

Assortment no. 1 including 8 pump pushers and 3 stakes.



ASSORTMENT

MSA	Use	Kg
13.111	With broach Ø 3 mm	0.086
13.111-4	With broach Ø 4 mm	0.086

Assortment no. 3 including 12 pump pushers and 6 stakes.

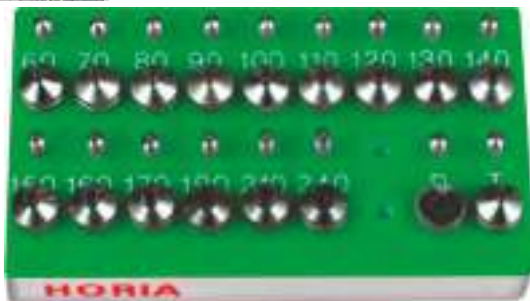

ASSORTMENT

MSA	Use	Kg
13.113	With broach Ø 3 mm	0.124
13.113-4	With broach Ø 4 mm	0.124

Assortment no. 2 including 15 pump pushers, 15 stakes, 1 set for the pallet-staff and 1 for pushing darts.

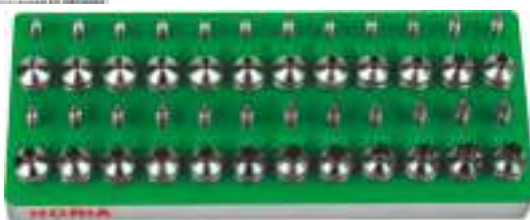

ASSORTMENT

MSA	Use	Kg
13.112	With broach Ø 3 mm	0.188
13.112-4	With broach Ø 4 mm	0.188

Assortment no. 4 including 24 pump pushers and 24 stakes.

JEWELLING PRESSES

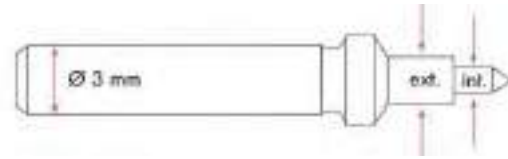

MSA	No. pusher	Internal Ø	External Ø	Kg
13.120-3040	40	0.20 mm	0.40 mm	0.001
13.120-3050	50	0.20 mm	0.50 mm	0.001
13.120-3060	60	0.40 mm	0.55 mm	0.001
13.120-3070	70	0.40 mm	0.65 mm	0.001
13.120-3080	80	0.40 mm	0.75 mm	0.001
13.120-3090	90	0.50 mm	0.85 mm	0.001
13.120-3100	100	0.50 mm	0.95 mm	0.001
13.120-3110	110	0.50 mm	1.05 mm	0.001
13.120-3120	120	0.50 mm	1.15 mm	0.001
13.120-3130	130	0.70 mm	1.25 mm	0.001
13.120-3140	140	0.70 mm	1.35 mm	0.001
13.120-3150	150	0.70 mm	1.45 mm	0.001
13.120-3160	160	0.70 mm	1.55 mm	0.001
13.120-3170	170	0.70 mm	1.65 mm	0.001

MSA	No. pusher	Internal Ø	External Ø	Kg
13.120-3180	180	0.70 mm	1.75 mm	0.001
13.120-3190	190	0.80 mm	1.85 mm	0.001
13.120-3200	200	0.80 mm	1.95 mm	0.001
13.120-3210	210	0.80 mm	2.05 mm	0.001
13.120-3220	220	0.80 mm	2.15 mm	0.001
13.120-3230	230	0.80 mm	2.25 mm	0.001
13.120-3240	240	0.80 mm	2.35 mm	0.001
13.120-3250	250	0.80 mm	2.45 mm	0.001
13.120-3260	260	0.80 mm	2.55 mm	0.001
13.120-3270	270	0.80 mm	2.65 mm	0.001
13.120-3280	280	0.80 mm	2.75 mm	0.001
13.120-3290	290	0.80 mm	2.85 mm	0.001
13.120-3300	300	0.80 mm	2.95 mm	0.001

Pump pushers for Ø 3 mm broaches of presses MSA13.100, MSA13.101 and MSA13.102-3.

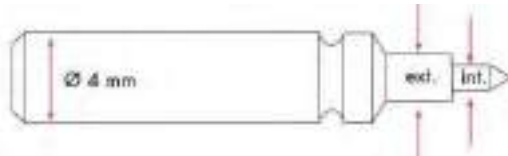

MSA	No. pusher	Internal Ø	External Ø	Kg
13.120-4040	40	0.20 mm	0.40 mm	0.001
13.120-4050	50	0.20 mm	0.50 mm	0.001
13.120-4060	60	0.40 mm	0.55 mm	0.001
13.120-4070	70	0.40 mm	0.65 mm	0.001
13.120-4080	80	0.40 mm	0.75 mm	0.001
13.120-4090	90	0.50 mm	0.85 mm	0.001
13.120-4100	100	0.50 mm	0.95 mm	0.001
13.120-4110	110	0.50 mm	1.05 mm	0.001
13.120-4120	120	0.50 mm	1.15 mm	0.001
13.120-4130	130	0.70 mm	1.25 mm	0.001
13.120-4140	140	0.70 mm	1.35 mm	0.001
13.120-4150	150	0.70 mm	1.45 mm	0.001
13.120-4160	160	0.70 mm	1.55 mm	0.001
13.120-4170	170	0.70 mm	1.65 mm	0.001

MSA	No. pusher	Internal Ø	External Ø	Kg
13.120-4180	180	0.70 mm	1.75 mm	0.001
13.120-4190	190	0.80 mm	1.85 mm	0.001
13.120-4200	200	0.80 mm	1.95 mm	0.001
13.120-4210	210	0.80 mm	2.05 mm	0.001
13.120-4220	220	0.80 mm	2.15 mm	0.001
13.120-4230	230	0.80 mm	2.25 mm	0.001
13.120-4240	240	0.80 mm	2.35 mm	0.001
13.120-4250	250	0.80 mm	2.45 mm	0.001
13.120-4260	260	0.80 mm	2.55 mm	0.001
13.120-4270	270	0.80 mm	2.65 mm	0.001
13.120-4280	280	0.80 mm	2.75 mm	0.001
13.120-4290	290	0.80 mm	2.85 mm	0.001
13.120-4300	300	0.80 mm	2.95 mm	0.001

Pump pushers for Ø 4 mm broaches of presses MSA13.100-4, MSA13.101-4 and MSA13.102-4.



Spare part :

MSA	Item	Kg
13.120-R	Spring for pump pushers MSA13.120-xxxx	0.001

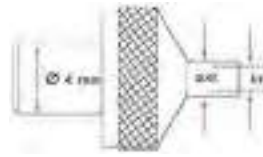

MSA	No. stake	Internal Ø	External Ø	Kg
13.121-050	50	0.60 mm	1.00 mm	0.002
13.121-060	60	0.70 mm	1.40 mm	0.002
13.121-070	70	0.80 mm	1.50 mm	0.002
13.121-080	80	0.90 mm	1.60 mm	0.002
13.121-090	90	1.00 mm	1.80 mm	0.002
13.121-100	100	1.10 mm	1.90 mm	0.002
13.121-110	110	1.20 mm	2.00 mm	0.002
13.121-120	120	1.30 mm	2.10 mm	0.002
13.121-130	130	1.40 mm	2.20 mm	0.002
13.121-140	140	1.50 mm	2.40 mm	0.002
13.121-150	150	1.60 mm	2.50 mm	0.002
13.121-160	160	1.70 mm	2.70 mm	0.002
13.121-170	170	1.80 mm	2.90 mm	0.002

MSA	No. stake	Internal Ø	External Ø	Kg
13.121-180	180	1.90 mm	3.00 mm	0.002
13.121-190	190	2.00 mm	3.20 mm	0.002
13.121-200	200	2.10 mm	3.30 mm	0.002
13.121-210	210	2.20 mm	3.40 mm	0.002
13.121-220	220	2.30 mm	3.50 mm	0.002
13.121-230	230	2.40 mm	3.60 mm	0.002
13.121-240	240	2.50 mm	3.80 mm	0.002
13.121-250	250	2.60 mm	4.00 mm	0.002
13.121-260	260	2.70 mm	4.10 mm	0.002
13.121-270	270	2.80 mm	4.20 mm	0.002
13.121-280	280	2.90 mm	4.30 mm	0.002
13.121-290	290	3.00 mm	4.40 mm	0.002
13.121-300	300	3.10 mm	4.50 mm	0.002

Stakes Ø 4 mm for presses MSA13.100, MSA13.100-4, MSA13.101, MSA13.101-4, MSA13.102-3 and MSA13.102-4.

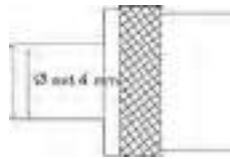

MSA	No. stake	External Ø	Kg
13.130-070	070	0.70 mm	0.003
13.130-080	080	0.80 mm	0.003
13.130-090	090	0.90 mm	0.003
13.130-100	100	1.00 mm	0.003
13.130-130	130	1.30 mm	0.003
13.130-150	150	1.50 mm	0.003
13.130-190	190	1.90 mm	0.003
13.130-200	200	2.00 mm	0.003

MSA	No. stake	External Ø	Kg
13.130-250	250	2.50 mm	0.003
13.130-300	300	3.00 mm	0.003
13.130-400	** 400	4.00 mm	0.003
13.130-500	500	5.00 mm	0.003
13.130-600	** 600	6.00 mm	0.003
13.130-700	700	7.00 mm	0.003
13.130-800	** 800	8.00 mm	0.003

Special flat stakes.

Other diameters available upon request.



ASSORTMENT

MSA	Use	Kg
13.122	With MSA13.100 + MSA13.101 + MSA13.102-3 (broach Ø 3 mm)	0.002
13.122-4	With MSA13.100-4 + MSA13.101-4 + MSA13.102-4 (broach Ø 4 mm)	0.002

Assortment of 1 pump pusher and 1 stake for pallet-staff.

Spare parts :

MSA	Item	Kg	
13.122-P	Pump pusher for broach Ø 3 mm, Ø int.0.2 - Ø ext. 0.8 mm	0.001	
13.122-P4	Pump pusher for broach Ø 4 mm, Ø int.0.2 - Ø ext. 0.8 mm	0.001	
13.122-T4	Stake Ø 4 mm for pallet-staff, Ø int.0.5 - Ø ext. 0.8 mm	0.002	

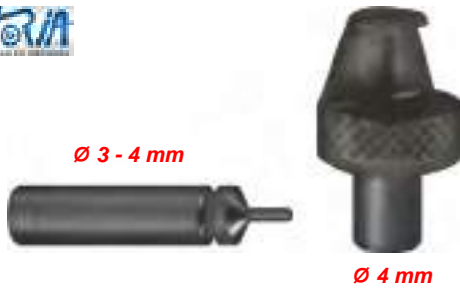

ASSORTMENT

MSA	Use	Kg
13.123	With MSA13.100 + MSA13.101 + MSA13.102-3 (broach Ø 3 mm)	0.002
13.123-4	With MSA13.100-4 + MSA13.101-4 + MSA13.102-4 (broach Ø 4 mm)	0.002

Assortment of 1 pump pusher and 1 stake for pushing darts.

Spare parts :

MSA	Item	Kg	
13.123-P	Pump pusher for broach Ø 3 mm	0.001	
13.123-P4	Pump pusher for broach Ø 4 mm	0.001	
13.123-T4	Stake Ø 4 mm for pushing darts	0.002	



Full pusher for broaches Ø 3 mm.

MSA	No.	Ø	Kg	MSA	No.	Ø	Kg	MSA	No.	Ø	Kg
13.124-3015	15	0.15 mm	0.001	13.124-3115	115	1.15 mm	0.001	13.124-3210	210	2.10 mm	0.001
13.124-3020	20	0.20 mm	0.001	13.124-3120	120	1.20 mm	0.001	13.124-3215	215	2.15 mm	0.001
13.124-3025	25	0.25 mm	0.001	13.124-3125	125	1.25 mm	0.001	13.124-3220	220	2.20 mm	0.001
13.124-3030	30	0.30 mm	0.001	13.124-3130	130	1.30 mm	0.001	13.124-3225	225	2.25 mm	0.001
13.124-3035	35	0.35 mm	0.001	13.124-3135	135	1.35 mm	0.001	13.124-3230	230	2.30 mm	0.001
13.124-3040	40	0.40 mm	0.001	13.124-3140	140	1.40 mm	0.001	13.124-3235	235	2.35 mm	0.001
13.124-3045	45	0.45 mm	0.001	13.124-3145	145	1.45 mm	0.001	13.124-3240	240	2.40 mm	0.001
13.124-3050	50	0.50 mm	0.001	13.124-3150	150	1.50 mm	0.001	13.124-3245	245	2.45 mm	0.001
13.124-3055	55	0.55 mm	0.001	13.124-3155	155	1.55 mm	0.001	13.124-3250	250	2.50 mm	0.001
13.124-3060	60	0.60 mm	0.001	13.124-3160	160	1.60 mm	0.001	13.124-3255	255	2.55 mm	0.001
13.124-3065	65	0.65 mm	0.001	13.124-3165	165	1.65 mm	0.001	13.124-3260	260	2.60 mm	0.001
13.124-3070	70	0.70 mm	0.001	13.124-3170	170	1.70 mm	0.001	13.124-3265	265	2.65 mm	0.001
13.124-3075	75	0.75 mm	0.001	13.124-3175	175	1.75 mm	0.001	13.124-3270	270	2.70 mm	0.001
13.124-3080	80	0.80 mm	0.001	13.124-3180	180	1.80 mm	0.001	13.124-3275	275	2.75 mm	0.001
13.124-3085	85	0.85 mm	0.001	13.124-3185	185	1.85 mm	0.001	13.124-3280	280	2.80 mm	0.001
13.124-3090	90	0.90 mm	0.001	13.124-3190	190	1.90 mm	0.001	13.124-3285	285	2.85 mm	0.001
13.124-3095	95	0.95 mm	0.001	13.124-3195	195	1.95 mm	0.001	13.124-3290	290	2.90 mm	0.001
13.124-3100	100	1.00 mm	0.001	13.124-3200	200	2.00 mm	0.001	13.124-3295	295	2.95 mm	0.001
13.124-3105	105	1.05 mm	0.001	13.124-3205	205	2.05 mm	0.001	13.124-3300	300	3.00 mm	0.001
13.124-3110	110	1.10 mm	0.001								



Full pusher for broaches Ø 4 mm.

MSA	No.	Ø	Kg	MSA	No.	Ø	Kg	MSA	No.	Ø	Kg
13.124-4015	15	0.15 mm	0.001	13.124-4145	145	1.45 mm	0.001	13.124-4275	275	2.75 mm	0.001
13.124-4020	20	0.20 mm	0.001	13.124-4150	150	1.50 mm	0.001	13.124-4280	280	2.80 mm	0.001
13.124-4025	25	0.25 mm	0.001	13.124-4155	155	1.55 mm	0.001	13.124-4285	285	2.85 mm	0.001
13.124-4030	30	0.30 mm	0.001	13.124-4160	160	1.60 mm	0.001	13.124-4290	290	2.90 mm	0.001
13.124-4035	35	0.35 mm	0.001	13.124-4165	165	1.65 mm	0.001	13.124-4295	295	2.95 mm	0.001
13.124-4040	40	0.40 mm	0.001	13.124-4170	170	1.70 mm	0.001	13.124-4300	300	3.00 mm	0.001
13.124-4045	45	0.45 mm	0.001	13.124-4175	175	1.75 mm	0.001	13.124-4305	305	3.05 mm	0.001
13.124-4050	50	0.50 mm	0.001	13.124-4180	180	1.80 mm	0.001	13.124-4310	310	3.10 mm	0.001
13.124-4055	55	0.55 mm	0.001	13.124-4185	185	1.85 mm	0.001	13.124-4315	315	3.15 mm	0.001
13.124-4060	60	0.60 mm	0.001	13.124-4190	190	1.90 mm	0.001	13.124-4320	320	3.20 mm	0.001
13.124-4065	65	0.65 mm	0.001	13.124-4195	195	1.95 mm	0.001	13.124-4325	325	3.25 mm	0.001
13.124-4070	70	0.70 mm	0.001	13.124-4200	200	2.00 mm	0.001	13.124-4330	330	3.30 mm	0.001
13.124-4075	75	0.75 mm	0.001	13.124-4205	205	2.05 mm	0.001	13.124-4335	335	3.35 mm	0.001
13.124-4080	80	0.80 mm	0.001	13.124-4210	210	2.10 mm	0.001	13.124-4340	340	3.40 mm	0.001
13.124-4085	85	0.85 mm	0.001	13.124-4215	215	2.15 mm	0.001	13.124-4345	345	3.45 mm	0.001
13.124-4090	90	0.90 mm	0.001	13.124-4220	220	2.20 mm	0.001	13.124-4350	350	3.50 mm	0.001
13.124-4095	95	0.95 mm	0.001	13.124-4225	225	2.25 mm	0.001	13.124-4355	355	3.55 mm	0.001
13.124-4100	100	1.00 mm	0.001	13.124-4230	230	2.30 mm	0.001	13.124-4360	360	3.60 mm	0.001
13.124-4105	105	1.05 mm	0.001	13.124-4235	235	2.35 mm	0.001	13.124-4365	365	3.65 mm	0.001
13.124-4110	110	1.10 mm	0.001	13.124-4240	240	2.40 mm	0.001	13.124-4370	370	3.70 mm	0.001
13.124-4115	115	1.15 mm	0.001	13.124-4245	245	2.45 mm	0.001	13.124-4375	375	3.75 mm	0.001
13.124-4120	120	1.20 mm	0.001	13.124-4250	250	2.50 mm	0.001	13.124-4380	380	3.80 mm	0.001
13.124-4125	125	1.25 mm	0.001	13.124-4255	255	2.55 mm	0.001	13.124-4385	385	3.85 mm	0.001
13.124-4130	130	1.30 mm	0.001	13.124-4260	260	2.60 mm	0.001	13.124-4390	390	3.90 mm	0.001
13.124-4135	135	1.35 mm	0.001	13.124-4265	265	2.65 mm	0.001	13.124-4395	395	3.95 mm	0.001
13.124-4140	140	1.40 mm	0.001	13.124-4270	270	2.70 mm	0.001	13.124-4400	400	4.00 mm	0.001

Pushers for fitting pins.



MSA	No. pusher	Internal Ø	External Ø	Kg
13.128-021	021	0.21 mm	0.80 mm	0.001
13.128-031	031	0.31 mm	0.80 mm	0.001
13.128-041	041	0.41 mm	0.90 mm	0.001
13.128-051	051	0.51 mm	1.00 mm	0.001
13.128-061	061	0.61 mm	1.10 mm	0.001
13.128-071	071	0.71 mm	1.20 mm	0.001
13.128-081	081	0.81 mm	1.30 mm	0.001
13.128-091	091	0.91 mm	1.40 mm	0.001
13.128-101	101	1.01 mm	1.50 mm	0.001

Special pusher for fitting pins Ø 3 mm.
Adjustable inner stop to ensure that pins are always fitting at the same height

Maximum fitting length : 3.00 mm.
External length of the pusher tip : 2.70 mm.

Presses for riveting and milling.

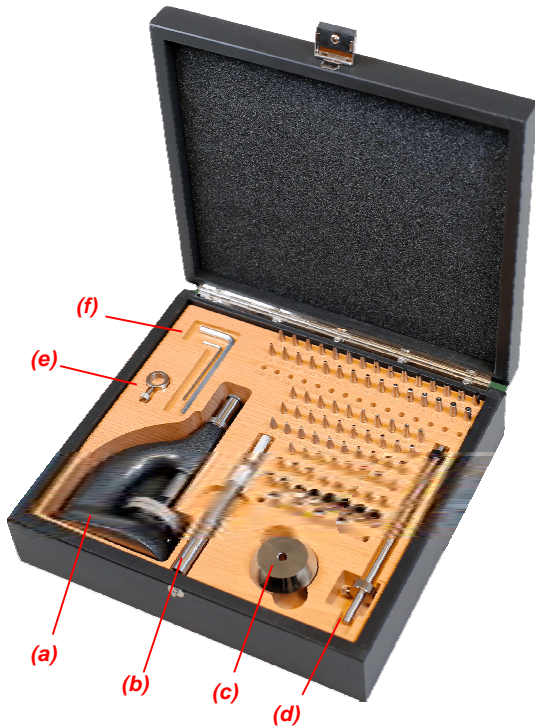

** See details of these components on the following pages

MSA	Box size	Kg
13.210	240 x 220 x 70 mm	2.750

Press for riveting and milling, full version.
Broach and table reaming \varnothing 4 mm.
Delivered in a wooden box.

Contents :

MSA	Item
03.856-x **	(R) ** 4x tightening chuck P4.5 type, \varnothing 1.0 + 1.5 + 2.0 + 3.0 mm
13.129-x	(T) ** 3x flat pierced stake, \varnothing 8 / hole \varnothing 3 + 4 + 5 mm
13.130-x	(S) ** 3x flat stake, \varnothing 4 / \varnothing ext. 4 + 6 + 8 mm
13.210-A	Empty box
13.210-B	(a) Press with table + broach + screw, anthracite
13.210-C	(b) Milling broach, for chucks P4.5, \varnothing ext. 10 x L113.50 mm
13.210-D	(c) Weight for rod, \varnothing 40 x 25 mm
13.210-E	(d) Rod for use with MSA13.210-C spindle and MSA13.210-D weight
13.210-F	Locknut for shank, \varnothing 15 / \varnothing 5 x 5 mm
13.210-G	(e) Locknut for broach, \varnothing 15 / \varnothing 10 x 5 mm
13.210-H15	(f) L Allen wrench, 1.50 mm
13.210-H40	(f) L Allen wrench, 4.00 mm
13.220-x	(G) ** 7x riveting punch, ball / \varnothing 1.00 ... 4.00 mm
13.221-x	(H) ** 15x riveting punch, domed pierced / hole \varnothing 0.30 ... 2.00 mm
13.222-x	(I) ** 15x riveting punch, flat pierced / hole \varnothing 0.30 ... 2.00 mm
13.223-x	(J) ** 10x riveting punch, concave, pierced / hole \varnothing 0.30 ... 1.60 mm
13.224-x	(K) ** 10x riveting punch, cylindrical domed / \varnothing 1.00 ... 3.00 mm
13.225-x	(L) ** 10x riveting punch, cylindrical flat / \varnothing 0.40 ... 3.00 mm
13.226-x	(M) ** 3x riveting punch, flat pierced ellipse / hole \varnothing 0.85 ... 1.20 mm
13.227-x	(N) ** 2x riveting punch, conical 45° + 60° / \varnothing 1.80 + 2.00 mm
13.228-x	(O) ** 2x conical milling point 40° + 60°
13.229-021	(P) ** Pair of lanterning punches 30°, No. 21
13.230-04	** Cylindrical pin, \varnothing 4 x L24 mm
13.230-H1	(Q) ** Reamer holder, No. H1 / \varnothing 5 x L16 mm / 2°
13.230-H2	(Q) ** Wheel countersink holder, No. H2 / \varnothing 5 x L16 mm / 1°

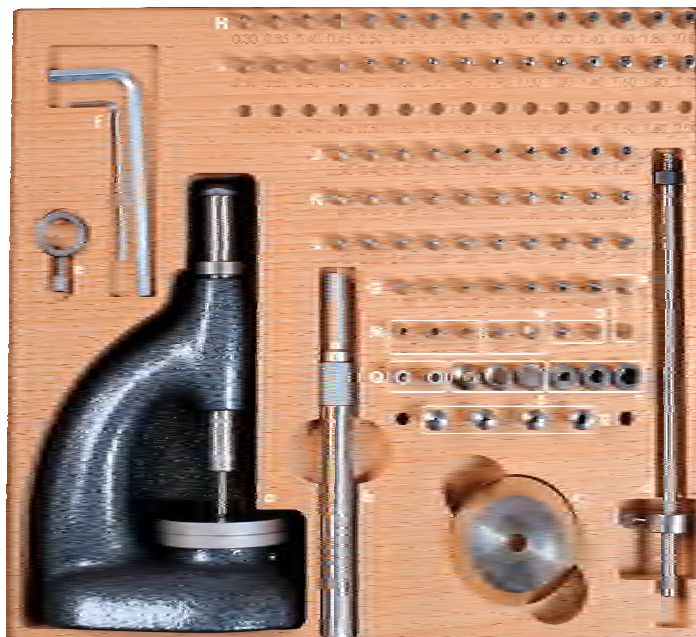

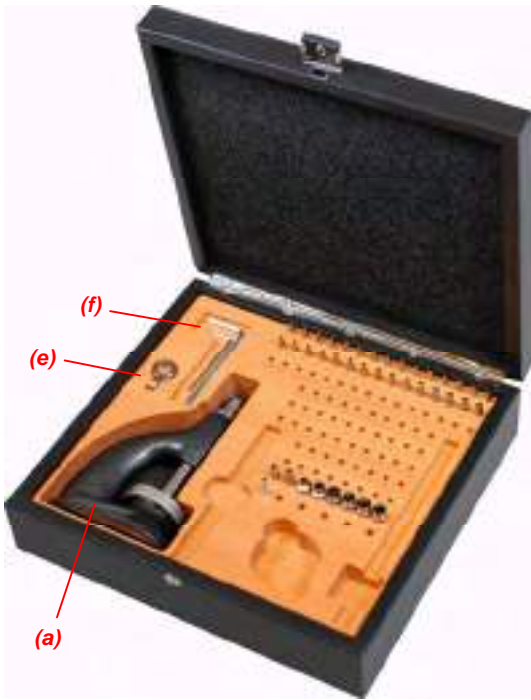

MSA	Box size	Kg
13.211	240 x 220 x 70 mm	2.315

Riveting press, light version.
Broach and table reaming Ø 4 mm.

Delivered in a wooden box.

Contents :

MSA	Item
13.129-x	(T) ** 3x flat pierced stake, Ø 8 / hole Ø 3 + 4 + 5 mm
13.130-x	(S) ** 3x flat stake, Ø 4 / Ø ext. 4 + 6 + 8 mm
13.210-A	Empty box
13.210-B	(a) Press with table + broach + screw, anthracite
13.210-G	(e) Locknut for broach, Ø 15 / Ø 10 x 5 mm
13.210-H15	(f) L Allen wrench, 1.50 mm
13.210-H40	(f) L Allen wrench, 4.00 mm
13.221-x	(H) ** 15x riveting punch, domed pierced / hole Ø 0.30 ... 2.00 mm
13.222-x	(I) ** 15x riveting punch, flat pierced / hole Ø 0.30 ... 2.00 mm
13.230-04	** Cylindrical pin, Ø 4 x L24 mm
13.230-H1	(Q) ** Reamer holder, No. H1 / Ø 5 x L16 mm / 2°
13.230-H2	(Q) ** Wheel countersink holder, No. H2 / Ø 5 x L16 mm / 1°

** See details of these components on the following pages

Riveting punches, with ball (delivered with the full version MSA13.210).



MSA	No.	Ø
13.220-100	100	1.00 mm
13.220-150	150	1.50 mm
13.220-200	200	2.00 mm
13.220-250	250	2.50 mm

MSA	No.	Ø
13.220-300	300	3.00 mm
13.220-350	350	3.50 mm
13.220-400	400	4.00 mm

Riveting punches, domed pierced (delivered with the full version MSA13.210 and light version MSA13.211).



MSA	No.	Ø	Ø hole
13.221-030	30	1.50 mm	0.30 mm
13.221-035	35	1.60 mm	0.35 mm
13.221-040	40	1.70 mm	0.40 mm
13.221-045	45	1.80 mm	0.45 mm
13.221-050	50	1.90 mm	0.50 mm
13.221-060	60	2.10 mm	0.60 mm
13.221-070	70	2.30 mm	0.70 mm
13.221-080	80	2.50 mm	0.80 mm

MSA	No.	Ø	Ø hole
13.221-090	90	2.70 mm	0.90 mm
13.221-100	100	3.00 mm	1.00 mm
13.221-120	120	3.30 mm	1.20 mm
13.221-140	140	3.50 mm	1.40 mm
13.221-160	160	3.70 mm	1.60 mm
13.221-180	180	3.90 mm	1.80 mm
13.221-200	200	4.10 mm	2.00 mm

Riveting punches, flat pierced (delivered with the full version MSA13.210 and light version MSA13.211).



MSA	No.	Ø	Ø hole
13.222-030	30	1.50 mm	0.30 mm
13.222-035	35	1.60 mm	0.35 mm
13.222-040	40	1.70 mm	0.40 mm
13.222-045	45	1.80 mm	0.45 mm
13.222-050	50	1.90 mm	0.50 mm
13.222-060	60	2.10 mm	0.60 mm
13.222-070	70	2.30 mm	0.70 mm
13.222-080	80	2.50 mm	0.80 mm

MSA	No.	Ø	Ø hole
13.222-090	90	2.70 mm	0.90 mm
13.222-100	100	3.00 mm	1.00 mm
13.222-120	120	3.30 mm	1.20 mm
13.222-140	140	3.50 mm	1.40 mm
13.222-160	160	3.70 mm	1.60 mm
13.222-180	180	3.90 mm	1.80 mm
13.222-200	200	4.10 mm	2.00 mm

Riveting punches, concave pierced (delivered with the full version MSA13.210).



MSA	No.	Ø	Ø hole
13.223-030	30	0.70 mm	0.30 mm
13.223-040	40	0.90 mm	0.40 mm
13.223-050	50	1.30 mm	0.50 mm
13.223-060	60	1.60 mm	0.60 mm
13.223-070	70	2.00 mm	0.70 mm

MSA	No.	Ø	Ø hole
13.223-080	80	2.10 mm	0.80 mm
13.223-100	100	2.50 mm	1.00 mm
13.223-120	120	2.70 mm	1.20 mm
13.223-140	140	3.00 mm	1.40 mm
13.223-160	160	3.10 mm	1.60 mm

Riveting punches, cylindrical domed (delivered with the full version MSA13.210).



MSA	No.	Ø
13.224-100	100	1.00 mm
13.224-120	120	1.20 mm
13.224-140	140	1.40 mm
13.224-160	160	1.60 mm
13.224-180	180	1.80 mm

MSA	No.	Ø
13.224-200	200	2.00 mm
13.224-220	220	2.20 mm
13.224-240	240	2.40 mm
13.224-260	260	2.60 mm
13.224-300	300	3.00 mm

Riveting punches, cylindrical flat (delivered with the full version MSA13.210).



MSA	No.	Ø
13.225-040	40	0.40 mm
13.225-050	50	0.50 mm
13.225-060	60	0.60 mm
13.225-080	80	0.80 mm
13.225-100	100	1.00 mm

MSA	No.	Ø
13.225-120	120	1.20 mm
13.225-150	150	1.50 mm
13.225-200	200	2.00 mm
13.225-250	250	2.50 mm
13.225-300	300	3.00 mm

Riveting punches, flat pierced and ellipse (delivered with the full version MSA13.210).



MSA	No.	Ø	Ø hole
13.226-085	85	2.20 mm	0.85 mm
13.226-100	100	2.30 mm	1.00 mm

MSA	No.	Ø	Ø hole
13.226-120	120	2.50 mm	1.20 mm

Flat pierced stakes (delivered with the full version MSA13.210 and light version MSA13.211).



MSA	No.	Ø	Ø hole
13.129-300	300	8.00 mm	3.00 mm
13.129-400	400	8.00 mm	4.00 mm
13.129-500	500	8.00 mm	5.00 mm

Flat stakes (** delivered with the full version MSA13.210 and light version MSA13.211).



MSA	No. stake	External Ø	Kg
13.130-070	070	0.70 mm	0.003
13.130-080	080	0.80 mm	0.003
13.130-090	090	0.90 mm	0.003
13.130-100	100	1.00 mm	0.003
13.130-130	130	1.30 mm	0.003
13.130-150	150	1.50 mm	0.003
13.130-190	190	1.90 mm	0.003
13.130-200	200	2.00 mm	0.003

MSA	No. stake	External Ø	Kg
13.130-250	250	2.50 mm	0.003
13.130-300	300	3.00 mm	0.003
13.130-400	** 400	4.00 mm	0.003
13.130-500	500	5.00 mm	0.003
13.130-600	** 600	6.00 mm	0.003
13.130-700	700	7.00 mm	0.003
13.130-800	** 800	8.00 mm	0.003

Special flat stakes.

Other diameters available upon request.

SCHAUBLIN chucks P4.5 type (delivered with the full version MSA13.210).



Ø 4.50 mm

MSA	Ø	Kg
03.856-100	1.00 mm	0.002
03.856-150	1.50 mm	0.002
03.856-200	2.00 mm	0.002
03.856-300	3.00 mm	0.002

Horotec® Chucks P 4.5 type.



Ø 4.50 mm

MSA	Ø	Kg
03.875-080	0.80 mm	0.002
03.875-100	1.00 mm	0.002
03.875-150	1.50 mm	0.002
03.875-160	1.60 mm	0.002
03.875-200	2.00 mm	0.002
03.875-235	2.35 mm	0.002
03.875-250	2.50 mm	0.002
03.875-300	3.00 mm	0.002
03.875-400	4.00 mm	0.002

Tightening chuck 4.5 type.

Other accessories for riveting and milling presses MSA13.210 and MSA13.211 :



(1)



(2)



(3)



(4)

MSA	Item
13.227-045 *	(1) Riveting punch with conical point, No. 45 / Ø 1.80 mm / 45°
13.227-060 *	Riveting punch with conical point, No. 60 / Ø 2.00 mm / 60°
13.228-045 *	Conical milling point, No. 45 / 40°
13.228-060 *	(2) Conical milling point, No. 60 / 60°
13.229-021 *	(3) Pair of lanterning punches, No. 21 / 30°
13.230-04 **	Cylindrical pin, Ø 4 x L24 mm
13.230-H1 **	(4) Reamer holder, No. H1 / Ø 5 x L16 mm / 2°
13.230-H2 **	Wheel countersink holder, No. H2 / Ø 5 x L16 mm / 1°

* Delivered with press MSA13.210 (full version)

** Delivered with presses MSA13.210 (full version) and MSA13.211 (light version)

STAKING TOOL FOR MILL

HOROTEC



MSA	Ø base reaming	Kg
13.105	4 mm	3.260

Staking tool for mill with 1 table and 1 broach for chuck P4.5 (chuck not included).

- Maximum distance between table and broach : 35 mm
- Opening : 28 mm
- Total height without broach : 110 mm
- Base length : 85 mm
- Table size : 80 x 50 mm
- Broach : Ø 8 mm.

Accessories for MSA13.105 (other Ø on request).

HOROTEC



Ø 4.50 mm

MSA	Ø	Kg
03.875-080	0.80 mm	0.002
03.875-100	1.00 mm	0.002
03.875-150	1.50 mm	0.002
03.875-160	1.60 mm	0.002
03.875-200	2.00 mm	0.002
03.875-235	2.35 mm	0.002
03.875-250	2.50 mm	0.002
03.875-300	3.00 mm	0.002
03.875-400	4.00 mm	0.002

Tightening chuck 4.5 type.

INCABLOC® assortments.



ASSORTMENT

MSA	Packaging size	Kg
13.153	70 x 34 x 20 mm	0.031

Assortment INCABLOC®. The 6 pushers and the 7 stakes have a Ø 4 mm axle and are compatible with the presses MSA13.100-4, MSA13.101-4 and MSA13.102-4 illustrated on pages 13-3 and 13-4.

Contents (pushers) :	Contents (stakes) :
- Ø ext. 1.60 mm, Ø hole 1.20 mm	- Ø ext. 1.60 mm, Ø hole 1.20 mm
- Ø ext. 1.90 mm, Ø hole 1.40 mm	- Ø ext. 2.00 mm, Ø hole 1.60 mm
- Ø ext. 2.00 mm, Ø hole 1.60 mm	- Ø ext. 2.30 mm, Ø hole 1.90 mm
- Ø ext. 2.50 mm, Ø hole 1.90 mm	- Ø ext. 2.50 mm, Ø hole 2.00 mm
- Ø ext. 3.00 mm, Ø hole 2.40 mm	- Ø ext. 3.00 mm, Ø hole 2.50 mm
- Ø ext. 3.50 mm, Ø hole 2.80 mm	- Ø ext. 3.50 mm, Ø hole 3.00 mm
	- Ø ext. 4.00 mm, Ø trou 3.50 mm



ASSORTMENT

MSA	Packaging size	Kg
13.154	90 x 65 x 25 mm	0.110

Assortment INCABLOC®. The 6 pushers and 7 stakes have a Ø 3 mm axle and are compatible with the presses MSA13.100, MSA13.101 and MSA13.102-3 illustrated on pages 13-3 and 13-4.

Contents (pushers) :	Contents (stakes) :
- Ø ext. 1.57 mm, Ø hole 0.80 mm	- Ø ext. 1.65 mm, Ø hole 1.35 mm
- Ø ext. 1.87 mm, Ø hole 1.50 mm	- Ø ext. 2.00 mm, Ø hole 1.60 mm
- Ø ext. 2.07 mm, Ø hole 1.70 mm	- Ø ext. 2.30 mm, Ø hole 1.90 mm
- Ø ext. 2.47 mm, Ø hole 2.00 mm	- Ø ext. 2.50 mm, Ø hole 2.10 mm
- Ø ext. 2.97 mm, Ø hole 2.50 mm	- Ø ext. 3.00 mm, Ø hole 2.50 mm
- Ø ext. 3.47 mm, Ø hole 3.00 mm.	- Ø ext. 3.50 mm, Ø hole 3.00 mm
	- Ø ext. 4.00 mm, Ø trou 3.50 mm.

KIF® spring-twister tools.



MSA	Packaging size	Kg
13.155	50 x 30 x 6 mm	0.004

KIF® shock absorber with non-attached spring. The non-attached spring of KIF 1 (Trior) is locked by rotation. In order to simplify operations for the watch repair during assembly or dismounting, KIF-PARECHOC® have designed a small tool known as "spring-twister".
Delivered in a small plastic box containing 3 spring-twister for fitting diameters 1.60, 1.90 and 2.10 mm.

Spare parts :

MSA	Item	Kg
13.150	Spring-twister KIF® 160, size Ø 2 x length 25 mm	0.001
13.151	Spring-twister KIF® 190, size Ø 2 x length 25 mm	0.001
13.152	Spring-twister KIF® 210, size Ø 2 x length 25 mm	0.001

14



VIDEO INSPECTION SYSTEMS

14 - 2

MICROSCOPES SWISSMETROLOGIE® "PREMIUM"

14 - 10

MICROSCOPES SWISSMETROLOGIE® "SILVER"

14 - 14

ERGO AND DISCUSSION SWISSMETROLOGIE® MICROSCOPES

14 - 16

LIGHTING

14 - 17

CAMERA

14 - 21



Video inspection system HD SMV-1.

SWISS METROLOGIE



MSA	Stand and screen
14.160 (1)	Stand with geared column MSA14.471 Screen 10"
14.161 (2)	Stand with detached arm MSA14.472 Screen 10"
14.162	Stand with extension arm MSA14.399 Screen 10"

The SMV-1 HD video inspection system combines the latest high-definition video technology with the best macro lens providing an exceptionally fluid image quality.

- The integrated 10" flat screen improves image quality and operator comfort
- The dome lighting technique by reverberation enables an optimised surface inspection even on polished and glazed parts
- The macro zoom 10x (13-130 mm) ensures intuitive and fast ease of use.

Key features :

- HD Camera 720P with an integrated 10" flat screen
- Image is captured directly onto the SD memory card
- Remote screen control with a pointing sight
- Indirect LED lighting dimmer by reverberation
- Optical zoom Computar 10x (13-130 mm) providing excellent quality and a working distance from 152 mm to 450 mm
- Zoom magnification from 3x up to 55x, with a wide field of view.

Technical characteristics :

- Digital sensor CMOS 1/2.5"
- Resolution 1280 x 800 @ 60 fps (24 bits), 16.10 aspect ratio
- 2 megapixels
- Individual adjustment of the screen colours : Red, Green and Blue
- Automatic or manual white balance
- Automatic or manual image contrast.



Items included in the delivery, in addition to the following compositions :

- MSA14.150-E : Dome lighting with LED + lighting intensity dimmer
- MSA14.151-P : Protection cover in semi-transparent PVC-Foil
- MSA14.150-SD : - SD memory card 8 GB.

SMV-1	Stand	Camera (with screen)	Optical zoom
MSA14.160 (1) =	MSA14.471 +	MSA14.150-C (10") +	MSA14.151-Z : 3x ... 55x
MSA14.161 (2) =	MSA14.472 +	MSA14.150-C (10") +	MSA14.151-Z : 3x ... 55x
MSA14.162 =	MSA14.399 +	MSA14.150-C (10") +	MSA14.151-Z : 3x ... 55x

Video inspection system FULL HD SMV-2.

SWISS METROLOGIE



(1)



(2)

MSA	Stand and screen
14.163 (1)	Stand with geared column MSA14.471 Screen 13.3"
14.164 (2)	Stand with detached arm MSA14.472 Screen 13.3"
14.165	Stand with extension arm MSA14.399 Screen 13.3"
14.168	Stand with geared column MSA14.471 Free-standing screen 23.8"

The SMV-2 FULL HD video inspection system is an intuitive inspection device with an exceptional image quality and fluidity on any HDMI-linked screen.

- New Full HD 13.3" flat screen for unrivalled image quality and operator comfort
- Recording pictures to a USB stick.

Key features :

- Full HD camera 1080P-HDMI controlled by a wireless mouse
- LED incident lighting with an intensity dimmer
- Optical zoom Computar 10x (13-130 mm) provides excellent quality and a working distance from 152 mm to 450 mm
- Zoom magnification from 3x up to 50x, with a wide field of view.

Technical characteristics :

- Digital sensor CMOS 1/2" Backlit
- Full HD resolution 1920 x 1080 @ 60 fps
- 5 megapixels
- Individual adjustment of the screen colours : Red, Green and Blue
- Automatic or manual white balance
- Automatic or manual image contrast
- HDMI connection.

Items included in the delivery, in addition to the following compositions :

- MSA14.150-E : Dome lighting with LED + lighting intensity dimmer
- MSA14.151-P : Protection cover in semi-transparent PVC-Foil
- DOCPUB.USBKEY : USB key 4 Gb with lanyard 80 cm
- MSA14.150-S : Wireless mouse.

SMV-2	Stand	Screen	Camera	Optical zoom
MSA14.163 (1) =	MSA14.471 +	MSA14.151-M (13.3") +	MSA14.151-D +	MSA14.151-Z : 3x ... 55x
MSA14.164 (2) =	MSA14.472 +	MSA14.151-M (13.3") +	MSA14.151-D +	MSA14.151-Z : 3x ... 55x
MSA14.165 =	MSA14.399 +	MSA14.151-M (13.3") +	MSA14.151-D +	MSA14.151-Z : 3x ... 55x
MSA14.168 =	MSA14.471 +	MSA14.153-M (23.8") +	MSA14.151-D +	MSA14.151-Z : 3x ... 55x

Video inspection system HD SMV-3 "Focus Stacking".

SWISS METROLOGIE



(1)



With "Focus Stacking" function



Without "Focus Stacking" function



(2)

MSA	Stand and screen
14.170 (1)	Stand with geared column MSA14.473 Screen 13.3"
14.171	Stand with geared column MSA14.473 Screen 23.8"
14.180 (2)**	Stand with geared column MSA14.400 (black base) Screen 23.8"

The SMV-3 video inspection system "Focus Stacking" is the latest intuitive solution from HOROTEC SA.

The "Focus Stacking" is a process in which several photos with different focus are merged to obtain an image with a large depth of field.

Main features :

- "Focus Stacking" function operational without a PC
- Full HD-5 MP camera, 1920 x 1080P @60 fps
- Full HD 13.3" flat screen
- Image storage on Ethernet network or USB stick
- New ergonomic stand with integrated wiring
- Transmitted and incident lighting as standard equipment
- Connection type : HDMI
- Zoom magnification from 3x up to 55x, with a wide field of view (from 30x up to 200x for MSA14.180).

** Graphic measurement software, PC-free, with automatic edge detection function

MSA14.170 : Without measuring functions / Without measuring table

MSA14.171 : With measuring functions / Without measuring table

MSA14.180 : With measuring functions / With measuring table

Main measurement functions of the camera MSA14.153-C :

- Calibration according to the type of measurement : linear or diameter.
- Measurement types :
 - Distance between 2 points, 1 line/1 point and 2 lines
 - Angular between 2 lines - Circle, arc of circle
 - Distance between 1 point/1 circle, 1 line/1 circle and 2 circle centers
 - Concentricity - Rectangle, polygon.
- Capture point :
 - Automatic or manual edge detection function.

Items included in the delivery, in addition to the following compositions :

** - MSA15.614 : Measuring table "X-Y" with rotating circular plate in glass (delivered without stops)

- MSA14.150-E : Dome lighting with LED + lighting intensity dimmer
- MSA14.151-P : Protection cover in semi-transparent PVC-Foil
- DOCPUB.USBKEY : USB key 4 Gb with lanyard 80 cm
- MSA14.150-S : Wireless mouse.

SMV-3	Statif	Screen	Camera	Optical zoom
MSA14.170 (1) =	MSA14.473 +	MSA14.151-M (13.3") +	MSA14.153-CSM +	MSA14.151-Z : 3x ... 55x
MSA14.171 =	MSA14.473 +	MSA14.153-M (23.8") +	MSA14.153-C +	MSA14.151-Z : 3x ... 55x
MSA14.180 (2) =	MSA14.471 +	MSA14.153-M (23.8") +	MSA14.153-C +	MSA14.153-Z : 30x ... 200x (*)
Optical zoom :	(*) 6-position indexable 6000 optical zoom with zoom position memory in software			

Video inspection system FULL HD SMV-B.

SWISS METROLOGIE



MSA

14.154

The video inspection system SMV-B FULL HD is an intuitive and compact inspection device, capable of filming a meticulous operation live, thanks to a large field depth and an exceptional image fluidity on any screen with an HDMI connection.

- Live viewing in FULL HD quality on any screen with an HDMI connection ; video projector, TV, PC monitor, etc.
- Possibility of streaming via an optional PC converter
- Recording of films and photos on SD card or USB key
- Viewing captured photos directly on the screen.

Key features :

- Full HD 1080P-HDMI camera controlled by wireless mouse
- Optical Zoom Macro 10x (13-130mm) providing an excellent quality and a working distance from 160 mm to 500 mm.

Technical characteristics :

- Digital sensor CMOS 1/3" colour
- Full HD resolution 1920 x 1080 @ 30 fps (12bits), 16.10 aspect ratio
- 2 Megapixels
- Adjustment of the screen colours : Blue - Red - Green
- Automatic or manual white balance
- Automatic or manual image contrast
- Backup : 8 GB SD card or USB stick (not included)
- Connection type : HDMI.

Items included in the delivery :

- 1 FULL HD camera
- 1 HDMI cable 70 cm
- 1 wireless mouse
- 1 Optical zoom Macro 10x (13-130 mm)
- 1 SD memory card
- 1 Z-tripod 200 mm.

Optional :

MSA	Item
14.151-U	(1) HDMI-USB signal converter for PC connection



Connect your HOROTEC inspection system (SMV-B / SMV-2 / SMV-3) with the HDMI/USB 3.0 signal converter (MSA14.151-U) and share your video inspection system camera live using the following video conferencing applications :



Stands.

SWISS METROLOGIE



MSA	Kg
14.471	5.300

Stand with 520 mm geared column in "Z" with fine adjustment.

Optional :
 - MSA14.150-A, arm to detach the screen
 - MSA14.471-A, optical head support.

SWISS METROLOGIE



MSA	Kg
14.473	5.300

Stand with 520 mm geared column, transmitted lighting with integrated LED (without zoom support).

SWISS METROLOGIE



MSA	Kg
14.472	18.430

Stand with a horizontal movement and a 370 mm column in "Z" and an arm to detach up to 422 mm.

Optional :
 - MSA14.150-A, arm to detach the screen
 - MSA14.471-A, optical head support.

Accessories.



MSA		Size	Kg
14.156	(1)	123 x 115 x 150 mm	0.630
14.157	(2)	123 x 115 x 250 mm	0.770

Transparent protective cover for video inspection and measuring systems.



MSA		Length	Kg
14.150-A		500 mm	0.560

Articulated arm for detaching the screen of the camera from the SMV-1 MSA14.150.

Delivered without screen.



MSA		Kg
14.471-A		0.330

Optical head support for stands MSA14.471 and MSA14.472.



MSA		Length	Kg
14.150-Y		300 mm	0.035

Connection "X" HDMI cable to connect a second external screen for a synchronized picture.

1x male and 2x female.



MSA	Type
14.151-Y2	1 input-2 output
14.151-Y4 (1)	1 input-4 output
14.151-Y8	1 input-8 output

HDMI splitter with amplifier, Full HD signal.



MSA	Type
14.151-W3	2 input-1 output

HDMI switch for distribution of Full HD signal.



MSA	Type
14.151-H1.5 (1)	HDMI, length 1.50 m
14.151-H2	HDMI, length 2 m
14.151-I (2)	HDMI 4K High Speed, length 5 m
14.151-H	HDMI 4K High Speed, length 10 m
14.151-H20	HDMI 4K High Speed, length 20 m

HDMI shielded cable.



MSA
14.150-L

SD Memory card reader.



MSA	Magnification	Kg
14.150-1.5X (1)	1.5x	0.055
14.150-2.0X	2.0x	0.055
14.150-3.0X	3.0x	0.030
14.150-5.0X	5.0x	0.036

Magnifying lens with C-mounting male/female.



MSA

15.614

Measuring table "X-Y" with rotating circular plate in glass for alignment of the parts.

- Travel 50 x 50 mm
- Clamping device for micrometres Ø 18 mm
- For stand MSA14.400.

Delivered without stops (optional).



MSA

Size

Kg

14.150-T

115 x 115 x 15 mm
Ø 95 mm

0.440

Black aluminium table support for transmitted lighting MSA14.150-G.

Delivered without lighting.



MSA

Size of items

Kg

14.447

Base Ø 95 mm
Top plate Ø 75 mm

0.265

Adjustable aluminium table on swivel to observe movements or components under a binocular, a trinocular or an inspection system.

- The base is compatible with the stands of the SwissMetrologie® range
- The top plate is covered with an anti-skid coating MSA14.447-A (replaceable when worn).

Spare part :

MSA

Item

Kg

14.447-A

Anti-skid coating, Ø 70 mm

0.005

2 series of stereoscopic binocular and trinocular microscopes associated to the latest Full HD cameras.



SWISSMETROLOGIE
Premium



SWISSMETROLOGIE
Silver



"PREMIUM" range optical features :

Auxiliary objective	0.5x	0.75x	1.0x	1.5x	2.0x
Working distance	200 mm	120 mm	100 mm	47 mm	26 mm
-					
Magnification 10x	3.4x ... 22.5x	4.7x ... 31.5x	6.7x ... 45.0x	10.1x ... 67.5x	13.4x ... 90.0x
Field of view (mm)	65.7 ... 9.8	46.9 ... 7.0	32.8 ... 4.9	21.9 ... 3.3	16.4 ... 2.4
-					
Magnification 15x	5.0x ... 33.8x	7.0x ... 47.3x	10.1x ... 67.5x	15.1x ... 101.3x	20.1x ... 135.0x
Field of view (mm)	47.8 ... 7.1	34.1 ... 5.1	23.9 ... 3.6	15.9 ... 2.4	11.9 ... 1.8
-					
Magnification 20x	6.7x ... 45.0x	9.4x ... 63.0x	13.4x ... 90.0x	20.1x ... 135.0x	26.8x ... 180.0x
Field of view (mm)	35.8 ... 5.3	25.6 ... 3.8	17.9 ... 2.7	11.9 ... 1.8	9.0 ... 1.3

"PREMIUM" series. Stereoscopic binocular and trinocular microscopes.

A new design more ergonomic - Compact and lightweight - Cleaner image in the periphery - Large coverage of magnification - Long working distance.

Main features :

- Powerful and advanced optical system for a better rendering of stereoscopic image
- Working distance of 104 mm, can be extended from 26 mm to 200 mm with optional lenses
- Magnification domain from 2x to 180x using optional objectives and eyepieces.

SWISSMETROLOGIE
SWISS METROLOGIE

MSA		Type	Stand	Voltage	Kg
14.430	(1)	Binocular	Rack and pinion	110 / 220 V	5.800
14.431	(2)	Binocular	Detached	-	20.400

Stereo binocular microscope with zoom magnification variable from 0.67x to 4.5x.

Eyepieces : Pair of eyepieces WF10x/22 mm in 45° inclined tubes with dioptre adjustment.

Objective : Standard total magnifications from 6.67 to 45x. Fields of view from 33 to 4.9 mm.

Working distance 110 mm.

Stand : Rack and pinion in metal, transmitted lighting with dimmer switch (1) or detached with 2 arms (2).

MSA14.430 only : delivered with 1 stage plate and 2 object clamps.



Lighting : see pages 14-17...14-20.



SWISSMETROLOGIE
Premium



(1)

MSA	Type	Stand	Voltage	Kg
14.432	(1)	Rack and pinion	110 / 220 V	7.180
14.433	(2)	Detached	-	24.600

Stereo binocular microscope with zoom magnification variable from 0.67x to 4.5x.

Eyepieces : Pair of eyepieces WF10x/22 mm in 45° inclined tubes with dioptré adjustment.

Objective : Standard total magnifications from 6.67 to 45x. Fields of view from 33 to 4.9 mm.
Working distance 110 mm.

Stand : Rack and pinion in metal, transmitted lighting with dimmer switch (1) or detached with 2 arms (2).

MSA14.432 only : delivered with 1 stage plate and 2 object clamps.

Lighting : see pages 14-17...14-20.



(2)

Accessories for "PREMIUM" stereoscopic microscopes.



MSA	Type	Kg
14.440-10	HWF 10x / 22 mm	0.188
14.440-15	HWF 15x / 16 mm	0.145
14.440-20 (1)	HWF 20x / 12 mm	0.224

Pair of eyepieces.



MSA	Type
14.441	HWF 10x / 22 mm

Micrometric eyepiece.



MSA	Kg
14.442	0.006

Pair of retractable eyeshades.



MSA	Magnification	Working distance	Kg
14.443-05	0.50x	185 mm	0.094
14.443-07 (1)	0.75x	125 mm	0.109
14.443-15	1.50x	50 mm	0.120
14.443-20	2.00x	33 mm	0.130

Additional lens.



MSA
14.444

Pair of object clamps.



MSA	Type	Ø
14.445-C (1)	Transparent	94 mm
14.445-D (2)	Black / White	94 mm

Spare stage plate.



MSA
14.446

F250 V1 amp glass fuse for stereoscopic microscopes SWISSMETROLOGIE® "PREMIUM" and "SILVER".
Set of 10 pieces.

"SILVER" series. Stereoscopic binocular microscopes for demanding professionals.
Modern design, more ergonomic - Compact and complete - Variable magnifications Zoom - 360° optical head - LED transmitted lighting.

Main features :

- **Powerful stereoscopic optical system for demanding industrial applications**
- **Working distance of 100 mm, can be extended up to 170 mm with the optional lenses and the stand with detached arm**
- **Magnification domain variable by zoom from 6.7x to 45x zoom and expandable up to 135x using optional lenses and eyepieces.**



MSA		Type	Stand	Voltage	Kg
14.434	(1)	Binocular	Rack and pinion	110 / 220 V	4.540
14.435	(2)	Binocular	Detached	-	15.400

Stereomicroscope with 45° binocular head and zoom objective with variable magnifications from 0.7x to 4.5x.

Eyepieces : Pair of eyepieces wide field WF10x / 20 mm, secure and delivered with eyeshades.

Head : Binocular with 45° inclined tubes, rotating at 360°. Two dioptre adjustments. Inter-pupillary distance from 55 to 75 mm.

Objective : A continuous Zoom objective with variable magnification from 0.7x to 4.5x for magnifications from 7x and 45x with fields of view from 28 to 4.4 mm.

Working distance 100 mm.

Other magnifications and working distances are possible using eyepieces WF 5x/18, WF 15x/15 or WF 20x/10 and additional lenses of 0.75x or 1.5x.

Stand : Rack and pinion in metal, large and ergonomic (1) or detached with 1 arm (2).

MSA14.434 only : delivered with transparent and black/white stage plates. Coarse adjustment with tension setting.

Lighting : see pages 14-17...14-20.



Accessories for "SILVER" stereoscopic microscopes.



MSA	Type
14.450-10	HWF 10x / 21 mm
14.450-15	HWF 15x / 16 mm
14.450-20	HWF 20x / 12 mm

Pair of eyepieces.



MSA	Type
14.451	HWF 10x / 22 mm

Micrometric eyepiece.



MSA	Kg
14.452	0.012

Pair of ergonomic eyeshades.



MSA	Magnification	Working distance	Kg
14.453-05	0.50x	170 mm	0.109
14.453-07	0.75x	114 mm	0.109

Additional lens.



MSA
14.454

Pair of object clamps.



MSA	Type	Ø
14.445-A	Transparent	60 mm
14.445-B	Black / White	60 mm

Spare stage plate.



MSA
14.446

F250 V1 amp glass fuse for stereoscopic microscopes SWISSMETROLOGIE® "PREMIUM" and "SILVER".
Set of 10 pieces.

Stereoscopic binocular microscopes ERGO range, ideal for combating musculoskeletal disorders (MSD).

SWISSMETROLOGIE



MSA	Magnification	Kg
14.241	5...50x	6.000
14.242	8...80x	6.000

Stereoscopic binocular microscope.

- Compact and lightweight
- Rack and pinion stand with fine adjustment
- Eyepieces 10x with 2 positions (high and low) for maximum comfort
- Ergonomic optical head, tilting from 0 to 35°
- The working distance of 80 mm can be extended to 160 mm with optional lenses
- Diascopic and incident LED lighting with intensity dimmer.

ERGONOMICS

Lighting : see pages 14-17...14-20.

Accessory for ERGO stereoscopic microscopes.

SWISSMETROLOGIE



MSA	Kg
14.243	0.250

Camera tube.

Stereoscopic binocular discussion microscope.

SWISSMETROLOGIE



MSA	Kg
14.457	43.740

Dual viewing stereoscopic binocular microscopes, without lighting.

- Equipped with a variable magnification Zoom from 8x to 50x (with eyepieces WF10x/22)
- Two binocular heads with individual adjustment of the interpupillary distance from 54 to 76 mm
- Adjustment of dioptres : +/-5.0.

Items included in the standard equipment :

- Cast iron large base (400 x 400 mm), rectified column length 450 mm and fine focusing drive
- Modular design discussion tube
- Two binocular heads with individual adjustment of the interpupillary distance and dioptre correction
- Two pairs of eyepieces WF 10x with eyeshades
- Indicator with adjustable luminous arrow
- Protection cover
- Glas plate 255 x 255 mm.

Lighting : see pages 14-17...14-20.

Lighting for binocular and trinocular microscopes.



MSA	Kg
14.150-G	0.325

LED transmitted lighting with dimmer.
External Ø 98 mm.



MSA	Size	Kg
14.150-T	115 x 115 x 15 mm Ø 95 mm	0.440

Black aluminium table support for transmitted lighting MSA14.150-G.
Delivered without lighting.



MSA	Voltage	Kg
14.313	220 V	0.700
14.313-110	110 V	0.700

Neon incident lighting fluorescent ring.
- 85 kHz
- Power 8 W
- Colour temperature 6000 K.
Maximum internal Ø 62 mm. External Ø 98 mm.
Delivered with additional neon.



MSA	LED	Voltage	Kg
14.312	60	90 - 260 V	0.360

Incident illumination ring of white LED.
- Dimmable from 0 to 100%
- Working distance 80...130 mm
- Colour temperature 6000 K
- Brightness 1400 lux at 100 mm
- LED lifetime up to 20'000 hours.
Maximum internal Ø 44.50 mm. External Ø 85 mm.



MSA	LED	Voltage	Kg
14.311	144	90 - 250 V	0.445

Incident illumination LED ring divided in 4 segments.
 - Dimmable from 0 to 100 %
 - Colour temperature 6500 K
 - Emits 20000 lux at 100 mm
 - Usable for working distances from 50 to 200 mm
 - LED lifetime up to 10'000 hours.
Maximum internal Ø 61 mm. External Ø 98 mm.



ANTIREFLECTING

MSA	LED	Voltage	Kg
14.317	164	90 - 240 V	0.463
14.317-5000K	164	90 - 240 V	0.463

Incident illumination LED ring divided in 3 segments.
 - Dimmable from 0 to 100 %
 - Colour temperature : 6500K (MSA14.317) / 5000 K (MSA14.317-5000K)
 - Emits 33'500 lux at 50 mm
 - Double diffuser.
Maximum internal Ø 63 mm. External Ø 105 mm.



MSA	LED	Voltage	Kg
14.315	8	95 - 265 V	0.850

Polarizing incident illumination ring of white LED with high brightness.
 - 1 W per LED
 - Dimmable from 0 to 100%
 - Colour temperature 6000 to 7000 K
 - Brightness 1800 lux.
Maximum internal Ø 62 mm. External Ø 90 mm.



MSA	Voltage	Kg
14.349	110 - 240 V	2.300

Multifunctional dual LED light source equipped with :
 - 2 flexible Gooseneck arms with a 1 W LED mounted at each end
 - 1 condenser lens
 - 1 dimmer switch.
 Each LED color temperature is 6500 K and emits 6500 lux at 100 mm.
 Network auto switching 110/240 V.
*Size : 120 x 160 x 75 mm.
 Length of Gooseneck arms : 440 mm (LED included).*

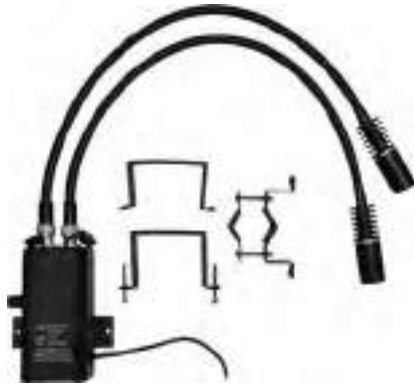

MSA	Voltage	Kg
14.354	90 - 240 V	1.500

Multifunctional dual LED light source equipped with :
 - 2 flexible Gooseneck arms with a 3 W LED mounted at each end
 - 1 dimmer switch.
 Each LED colour temperature is 6500 K and emits 12'000 lux at 100 mm.



MSA	LED	Voltage	Kg
14.150-E	120	110 - 240 V	1.205

Dome lighting with LED.
 - Dimmable from 0 to 100 %
 - Colour temperature 6500 K
 - Brightness 2000 lux.
Maximum internal Ø 66 mm. External Ø 160 mm. Height 86 mm.



MSA	Voltage
14.423	220 V

System of incident illumination ring LED over three rings.
 - Diffuser and intensity dimmer of 120'000 lux at 40 mm without heat release
 - Mobile and adjustable thanks to its support, fits the stands MSA14.400, MSA14.471 and MSA14.473 of the inspection systems SMV.
*Maximum internal Ø 143 mm. External Ø 165 mm.
 (Illumination available without mobile support).*

ANTIREFLECTING

14319



MSA	Voltage
14.319	220 V

Fibre optic lighting kit, incident BF and grazing DF. 2 lighting systems in 1 (bright field and dark field). Easy to set up and assemble, this lighting system fits all our types of microscopes of the PREMIUM and SILVER ranges, as well as all our video inspection systems SMV-1, SMV-2, SMV-3, etc.

The "ShadowLESS" concept combines high uniformity and high directional light in a unique way. These properties allow an unprecedented inspection comfort with high contrast images, a negligible presence of stray light reflections, therefore a lower eye fatigue and no heat dissipation.

The colour temperature is 5400 K. It remains constant throughout the system longevity, independently of the number of hours the product is used. This consistency enables the users to maintain a stable quality standard over time.

Working distance : BF = 50...150 mm / DF = 0...15 mm.
Lifetime : 20'000 hours.



BF
Incident lighting



DF
Grazing lighting

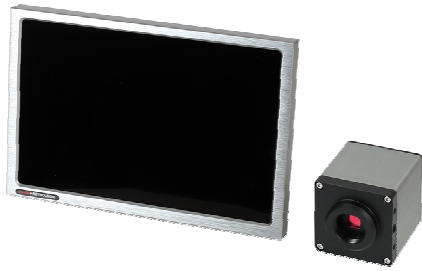

BF + DF
Incident and grazing lighting

FULL HD camera with HDMI connection (use without PC).

MSA	Kg
14.150-C	1.265

HD camera with 10" flat screen.

Technical characteristics :

Digital sensor	CMOS 1/2.5" Colour
HD resolution	1280 x 800 @ 60 fps (24 bits), 16.10 aspect ratio
Number of pixels	1 megapixel
Colour screen	Individual colour adjustment : Blue - Red - Green
White balance	Automatic or manual
Image contrast	Automatic or manual
Backup	Picture on SD memory card
Connection type	HDMI
Control	By wired remote control

NOTES

15



MEASURING INSTRUMENTS WITH FIXED DIMENSIONS

15 - 2

MEASURING INSTRUMENTS WITH VARIABLE DIMENSIONS

15 - 8

Rules and gauges.



MSA	Length	Graduations	Kg
15.001	150 mm	1 mm	0.009

Stainless steel flexible rule.



MSA	Length	Graduations	Kg
15.008-150 (1)	150 mm	0.5 / 1 mm	0.009
15.008-200 (2)	200 mm	0.5 / 1 mm	0.011

Stainless steel flexible rule.
MSA15.008-150 : double sided graduations.



MSA	Length	Graduations	Kg
15.003	120 mm	8...22 mm	0.003

Aluminium tool for measuring the distance between the lugs.



MSA	Length	Graduations	Kg
15.004	125 mm	6...22 mm	0.034

Tool with 2 arms for measuring the width of bracelets and the distance between the lugs.



MSA	Length	Kg
15.005	110 mm	0.006

Gauge for measuring the diameter (0...60 mm) or the number of lines of movements (2...24'').



(1)

MSA		Number of blades	Kg
15.014-13	(1)	13	0.066
15.014-20	(2)	20	0.100

Stainless steel thickness gauge.

MSA15.014-13 = 13 blades from 0.05 to 1.00 mm : 0.05 - 0.10 - 0.15 - 0.20 - 0.25 - 0.30 - 0.40 - 0.50 - 0.60 - 0.70 - 0.80 - 0.90 - 1.00 mm.

MSA15.014-20 = 20 blades from 0.05 to 1.00 mm : 0.05 - 0.10 - 0.15 - 0.20 - 0.25 - 0.30 - 0.35 - 0.40 - 0.45 - 0.50 - 0.55 - 0.60 - 0.65 - 0.70 - 0.75 - 0.80 - 0.85 - 0.90 - 0.95 - 1.00 mm.



(2)

Bevelled straight edges.



MSA	Length	Number of blades	Kg
15.006	75 mm	2 µm	0.060
15.016	100 mm	2 µm	0.110

Hardened steel bevelled straight edge.

Model with 1 bevelled edge, with insulating grip to limit the transfer of thermal heat during manual handling for optimal precision.

Delivered in 1 synthetic pouch.

Divider.



← 165 mm →

MSA	Length	Kg
15.205	200 mm	0.133

Stainless steel adjustable divider, straight tips.

Maximum opening : 165 mm.

Squares.



MSA	Size	Kg
15.085	50 x 40 mm	0.060
15.084	75 x 50 mm	0.072

Bevelled edge 90° square in hardened stainless steel.
Measuring faces fine scraped and lapped.
Accuracy according to DIN 875/00.



MSA	Size	Kg
15.086	100 x 70 mm	0.210

Flat and try 90° square in hardened stainless steel.
Lapped measuring faces.
Accuracy according to DIN 875.
Section 20 x 5 mm.



MSA	Size	Kg
15.087	150 x 100 mm	0.282

Simple 90° square in hardened stainless steel.
Lapped measuring faces.
Accuracy according to DIN 875.
Section 25 x 7 mm.

CARY® steel plug gauges TDH type.

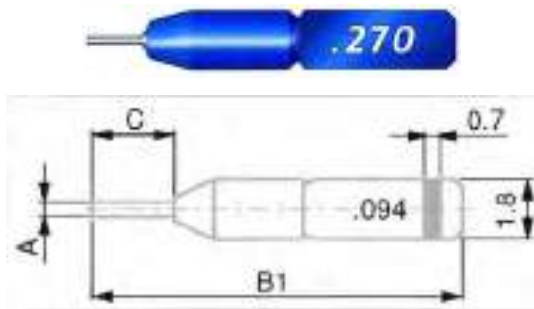

Ø A mm	B1 mm	C mm
0.050...0.109	10.3	0.8
0.110...0.159	10.5	1.0
0.060...0.209	10.7	1.4
0.210...0.309	11.1	1.6

MSA	Ø	Progression	Kg
15.032-x.xxx *	0.050...0.080 mm	0.002 mm (even sizes)	0.013
15.033-x.xxx *	0.051...0.079 mm	0.002 mm (uneven sizes)	0.013
15.034-x.xxx *	0.081...0.309 mm	0.002 mm (uneven sizes)	0.013
15.035-x.xxx *	0.082...0.308 mm	0.002 mm (even sizes)	0.013

CARY® steel plug gauge TDH type.
The most convenient and fastest method to check the small diameter holes. Because of their small size, it is necessary to use tweezers for their handling. Standard accuracy : ± 0.4 µm.

* Specify the exact diameter when ordering



MSA	Size	Kg
15.072	48 x 30 x 22 mm	0.022

Metal box for 10 CARY® plug gauges TDH type from Ø 0.050 to 0.309 mm.

CARY® steel plug gauges TLH type.

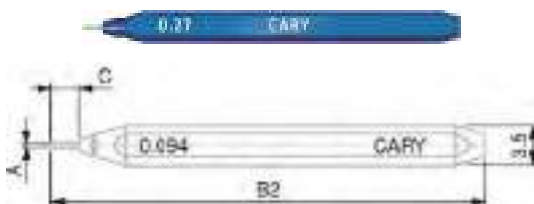

Ø A mm	B2 mm	C mm
0.050...0.109	31.8	0.8
0.110...0.159	32.0	1.0
0.060...0.209	32.2	1.4
0.210...0.309	32.6	1.6

MSA	Ø	Progression	Kg
15.021-x.xxx *	0.050...0.080 mm	0.002 mm (even sizes)	0.003
15.020-x.xxx *	0.051...0.079 mm	0.002 mm (uneven sizes)	0.003
15.022-x.xxx *	0.081...0.309 mm	0.002 mm (uneven sizes)	0.003
15.023-x.xxx *	0.082...0.308 mm	0.002 mm (even sizes)	0.003

CARY® steel plug gauge TLH type.
The TLH type is identical to the TDH type, but with a 30 mm-long handle. Standard accuracy : ± 0.4 µm.

* Specify the exact diameter when ordering



MSA	Size	Kg
15.068	80 x 82 x 47 mm	0.145

Wooden box for 25 CARY® plug gauges TLH type from Ø 0.050 to 0.309 mm.

Delivered without gauges.

CARY® steel simple plugs gauge TXH type.



Ø A mm	B1 mm	C mm	D mm
0.300...0.509	38	3	3.5
0.510...1.009	39	4	3.5
1.010...1.509	40	5	3.5
1.510...2.009	46	6	5
2.010...2.509	47	7	5
2.510...3.009	48	8	5
3.010...3.509	49	9	5
3.510...4.009	60	10	8
4.010...5.009	61	11	8
5.010...10.010	62	12	8

MSA	Ø	Progression	Kg
15.026-x.xxx *	0.300...1.508 mm	0.002 mm (even sizes)	0.003
15.024-x.xxx *	0.301...1.509 mm	0.002 mm (uneven sizes)	0.003
15.029-x.xxx *	1.510...3.508 mm	0.002 mm (even sizes)	0.004
15.027-x.xxx *	1.511...3.509 mm	0.002 mm (uneven sizes)	0.004
15.031-x.xxx *	3.510...10.000 mm	0.002 mm (even sizes)	0.007
15.030-x.xxx *	3.511...9.999 mm	0.002 mm (uneven sizes)	0.007

CARY® steel simple plug gauge TXH type.

Standard accuracy from Ø 0.300 to 3.000 mm : ± 0.4 µm.

Standard accuracy from Ø 3.000 to 10.000 mm : ± 0.5 µm.

* Specify the exact diameter when ordering



MSA	Size	Kg
15.069 (1)	135 x 85 x 60 mm	0.240
15.070 (2)	135 x 85 x 60 mm	0.545

Wooden box for 50 CARY® plug gauges TLH type.

(1) from Ø 0.300 to 1.509 mm

(2) from Ø 1.510 to 3.509 mm

Sets of metric gauge steel blocks MITUTOYO®.
Delivered in a wooden box with a certificate of inspection.

How to choose the accuracy grade :

- Grade 1 : gauge blocks of this class are mainly used as working standards to set and calibrate plug gauges and measuring instruments in measuring rooms or inspection areas within the production.
- Grade 2 : these gauge blocks are commonly used as working standards in inspection rooms within the production to set and calibrate measuring instruments and other equipment as well as to inspect tools, fixtures and machines.

Mitutoyo



MSA	Number of blocks	Accuracy grade	Kg
15.630	32	1	-
15.631	32	2	-

Set of metric gauge steel blocks MITUTOYO®.

Composition :

Quantity and size :	Increment :
1x 1.005 mm	-
9x 1.01...1.09 mm	0.01 mm
9x 1.10...1.90 mm	0.10 mm
9x 1.00...9.00 mm	1.00 mm
3x 10...30 mm	10 mm
1x 60 mm	-

Mitutoyo



MSA	Number of blocks	Accuracy grade	Kg
15.632	47	1	-
15.633	47	2	-

Set of metric gauge steel blocks MITUTOYO®.

Composition :

Quantity and size :	Increment :
1x 1.005 mm	-
19x 1.01...1.19 mm	0.01 mm
8x 1.20...1.90 mm	0.10 mm
9x 1.00...9.00 mm	1.00 mm
10x 10...100 mm	10 mm

Mitutoyo



MSA	Number of blocks	Accuracy grade	Kg
15.634	87	1	-
15.635	87	2	-

Set of metric gauge steel blocks MITUTOYO®.

Composition :

Quantity and size :	Increment :
9x 1.001...1.009 mm	0.001 mm
49x 1.01...1.49 mm	0.01 mm
19x 0.50...9.50 mm	0.50 mm
10x 10...100 mm	10 mm

MEASURING INSTRUMENTS WITH VARIABLE DIMENSIONS

Calipers with vernier reading.



MSA	Measuring range	Precision	Kg
15.100	150 mm	0.02 mm	0.275

Hardened steel caliper with vernier reading.
Delivered in 1 imitation leather pouch.



MSA	Measuring range	Precision	Kg
15.436	150 mm	0.02 mm	0.270

Hardened stainless steel standard caliper with vernier reading and locking screw.
Delivered in 1 synthetic case.

Dial calipers.



MSA	Measuring range	Precision	Kg
15.115	150 mm	0.02 mm	0.340

Hardened steel dial caliper. Rotating dial with locking screw.
Delivered in 1 synthetic case.

2 mm/revolution



MSA	Measuring range	Precision	Kg
15.104	150 mm	0.02 mm	0.350

CCMA-M hardened stainless steel dial caliper (steel gear mechanism, hardened and ground).
- Easy-to-read
- Slider with metal dial housing
- Rotating dial Ø 32 mm with locking screw.
Delivered in 1 synthetic case.

2 mm/revolution



MSA	Measuring range	Precision	Kg
15.422	150 mm	0.01 mm	0.360

CCMA-M hardened stainless steel dial caliper (steel gear mechanism, hardened and ground).
- Easy-to-read
- Slider with metal dial housing
- Rotating dial Ø 32 mm with locking screw.
Delivered in 1 synthetic case.

1 mm/revolution



MSA	Measuring range	Precision	Kg
15.110	150 mm	0.02 mm	0.370

ETALON 125 hardened stainless steel dial caliper (steel gear mechanism, hardened and ground).
- Slider with metal dial housing
- Rotating dial Ø 32 mm with locking screw.
Delivered in 1 synthetic case.

1 mm/revolution

Electronic calipers.



MSA	Measuring range	Precision	Kg
15.512	100 mm / 4"	0.01 mm / 0.0005"	0.170

Small hardened steel electronic caliper, very practical thanks to its reduced dimensions.

Delivered in 1 synthetic case.



MSA	Measuring range	Precision	Kg
15.510	150 mm / 6"	0.01 mm / 0.0005"	0.100

Synthetic electronic caliper.

Delivered in 1 transparent plastic case.



MSA	Measuring range	Precision	Kg
15.511	150 mm / 6"	0.01 mm / 0.0005"	0.325

Tempered steel electronic caliper.

Delivered in 1 synthetic case.



MSA	Measuring range	Precision	Kg
15.513	150 mm / 6"	0.01 mm / 0.005"	0.292

Hardened steel electronic caliper.

Big LCD display 15 mm.

Delivered in 1 synthetic case.



MSA	Measuring range	Precision	Kg
15.107	150 mm / 6"	0.01 mm / 0.005"	0.150
15.457	150 mm / 6"	0.01 mm / 0.005"	0.150
15.113	150 mm / 6"	0.01 mm / 0.005"	0.150
15.458	200 mm / 8"	0.01 mm / 0.005"	0.200
15.459	300 mm / 12"	0.01 mm / 0.005"	0.280

TWIN-CAL electronic caliper with the highest degree of protection ever reached. Resists to any penetration of liquids and particles of materials (metal or other).

- Degree of protection IP67
- Square depth rod : MSA15.107, MSA15.458 and MSA15.459
- Round depth rod : MSA15.457
- Round depth rod with thumb roller : MSA15.113
- The inductive measuring system, a TESA technology, guarantees reliability and high precision even in harsh conditions
- Equipped with TLC (TESA Link Connector), the unique integral data output facility, providing the opportunity to upgrade your caliper at any time
- LCD display, 11 mm
- Lithium battery 3 V, CR 2032.

Delivered in 1 synthetic case.



MSA	Measuring range	Precision	Kg
15.111	150 mm / 6"	0.01 mm / 0.0005"	0.150
15.112	150 mm / 6"	0.01 mm / 0.0005"	0.150
15.108	200 mm / 8"	0.01 mm / 0.0005"	0.150

TWIN-CAL electronic caliper. High degree of protection against dust.
 - Degree of protection IP40
 - Rectangular depth rod (MSA15.111 and MSA15.108, the latter with thumb roller) or round (MSA15.112 with thumb roller)
 - Equipped with an integrated data output. Simply connect the TWIN-CAL via the TLC (TESA Link Connector) to a PC and all your measurement results will be captured and stored for optimal SPC monitoring
 - LCD display, 11 mm
 - Lithium battery 3 V, CR 2032.
Delivered in 1 synthetic case.

Data transfer.



(1)



(2)

MSA		Model	Length	Kg
15.114	(1)	Opto-USB	2 m	0.045
15.117	(2)	Opto-Sub-D	2 m	0.040

Duplex connecting cable, bidirectional communication.
 Any connecting cable is defined by each of the connectors fitted at either end of the cable principally to suit the computer, and the measuring instrument being used. To achieve highest compatibility levels, TESA® uses only standardized and proven connectors.

MSA15.114 :
 - Opto RS232 connector (for instrument)
 - USB connector A type (for computer or system).

MSA15.117 :
 - Opto RS232 connector (for instrument)
 - Connector Sub-D 9 p/f Duplex (for computer or system).



MSA	Length	Kg
15.469	2 m	0.055

TLC-USB cable for instrument with TLC connector (TESA Link Connector).
 - TLC connector (for instrument)
 - USB connector (for computer or system).



(1)

(2)

MSA		Kg
15.524	(1)	0.100
15.523	(2)	0.150

USB accessory.

(1) Multiplexer, 7 USB ports 2.0.

- Robust steel housing
- External powering using a C-type AUX connector, 4 pins
- Delivered with : DC mains adapter (EU) and connecting cable to PC
- Recommended highest number of ports : 49 USB ports connectable on 2 levels.

(2) USB foot switch.

- Direct connection to any USB port
- Takes DataDirect or StatExpress into account when transferring the measured values from all connected measuring tools.

Wireless data transfer.



MSA		Kg
15.624		0.088

The Bluetooth® TLC-BLE emitter is adaptable to a very wide range of instruments to transfer data easily.

The Bluetooth® wireless transmitter allows to send the measured values of most TESA instruments to a computer. This wireless data transfer avoids transcription errors and improves the traceability. The emitters are quickly adaptable to all TLC connectors (TESA Link Connector) to upgrade both new and existing models.

Delivered with 1 emitter, 1 USB Dongle receiver and 1 extension cable 1.5 m.



MSA		Kg
15.625		-

Bluetooth® TLC-BLE emitter.



MSA		Kg
15.626		-

Adapter type OPTO-RS232/TLC with Velcro® strap for fixing the emitter.



MSA		Kg
15.522		0.110

Software DATA-DIRECT + dongle.

DATA-DIRECT software is an easy way to collect and report results in real time from the majority of the measuring instruments in the TESA range that have an RS232 output.

DATA-DIRECT is supplied not only with serial input/output drivers specially configured for TESA's products, but also for those purchased from other manufacturers. It works effectively to give data transfer for your data sheets, database, statistical modules or any other Windows-based applications.

- TESA® DATA-DIRECT installation CD + USB license key + user instructions (PDF version).

Printer.



MSA	Size	Kg
15.479	180 x 180 x 84 mm	0.550

PRINTER SPC portable printer.

- Intelligent printer designed for the inspection of finished parts or incoming goods
- Value classification
- Prints out measurement results with graphical representations
- 5 languages : French, German, English, Italian and Spanish
- Can be connected not only to TESA measuring instruments, but also to those provided with a DIGIMATIC output
- The printer is capable of recognising the connected tool and will execute the appropriate configuration automatically
- Adapter 100-240 V AC, 6.6 V DC
- Roll width : 110 mm
- Printing : 40 signs/line.

Spare part :

MSA	Item	Kg
15.480	Paper roll, width 110 mm	0.190

Boxes of instruments TESA®.



MSA	Kg
15.730	0.498

TESA® analogue measuring instruments box CS6 for apprentices, composed of :

- Dial caliper, with measuring range 150 mm, precision 0.02 mm
- Analogue micrometre, with measuring range from 0 to 25 mm, precision 0.01 mm
- Steel bevelled edge square, 100 x 70 mm
- Flexible rule 150 mm.

Delivered in 1 synthetic case.



MSA	Kg
15.731	0.469

TESA® digital measuring instruments box CS13 for apprentices, composed of :

- Electronic caliper (Protection IP67), with measuring range 150 mm, precision 0.01 mm
- Electronic micrometre, with measuring range from 0 to 30 mm, precision 0.001 mm
- Depth measuring foot.

Delivered in 1 synthetic case.

 sylvac



MSA	Kg
15.179	-

SYLVAC® digital measuring instruments box for apprentices, composed of :
 - Electronic caliper 150 mm, precision 0.01 mm (Protection IP67)
 - Electronic micrometre 0-30 mm
 - Flexible rule 150 mm
 - Precision square
 - 1 thread gauge + 1 radius gauge
 - Scriber 180 mm.
 Delivered in 1 synthetic case.

Lever indicators GIROD-TAST.

- High sensitivity, repeatability and accuracy (according to DIN 2270 standards). Unaffected by magnetic fields
- Automatic reversing contact point, with constant clockwise rotation
- Easy and error-free reading by only one revolution of the hand
- Robust one-piece housing ; corrosion resistant with satin chrome finish
- Designed for universal applications. Well-suited for workshop use.
- Interchangeable carbide contact point swivels over 240°.

 GIROD INSTRUMENTS

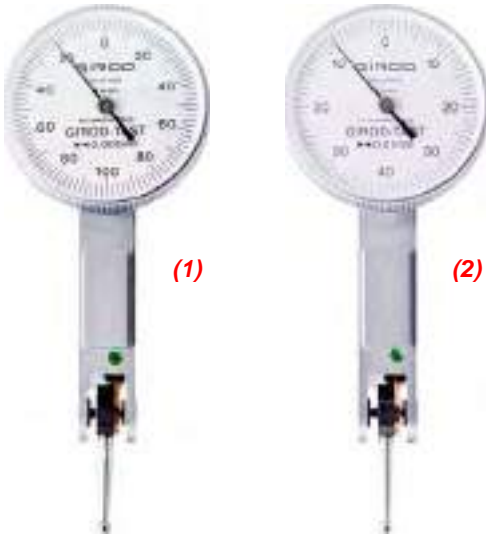

MSA	Measuring range	Precision	Ø dial	Circular scale	Kg
15.131 (1)	0.20 mm	0.002 mm	28 mm	0 - 100 - 0 mm	-
15.611	0.20 mm	0.002 mm	37 mm	0 - 100 - 0 mm	-
-	-	-	-	-	-
15.132 (2)	0.80 mm	0.01 mm	28 mm	0 - 40 - 0 mm	-
15.125	0.80 mm	0.01 mm	37 mm	0 - 40 - 0 mm	-

TESATAST standard lever indicator.

 GIROD INSTRUMENTS



MSA	Measuring range	Precision	Ø dial	Circular scale	Kg
15.133	0.80 mm	0.01 mm	28 mm	0 - 40 - 0 mm	-

TESATAST standard lever indicator.

Longitudinal lever

Digital dial gauges.



MSA	Model	Measuring range	Resolution	Degree of protection	Kg
15.638	DIALTRONOC EASY	12.50 mm 0.5"	0.01 mm 0.0005"	IP51	-
15.639	DIALTRONOC EASY	12.50 mm 0.5"	0.001 mm 0.00005"	IP51	-

DIALTRONOC EASY digital dial gauge, Ø 60 mm.

- Measuring force (N) : 0.65 - 0.90
- Indication error over measuring range (retractable plunger) MPEE (µm) : MSA15.638 (10 ± 1 digit) / MSA15.639 (4)
- Indication error over partial measuring range (over 1 mm) MPEP (µm) : MSA15.638 (8) / MSA15.639 (3)
- Repeatability of the indication error MPER (µm) : 2.

Standard features :

- Zeroing/Preset
- Data transmission
- Selection mm/inch
- Selection of measuring direction
- Automatic or manual switch-off
- Locking of the measured value.

Travel 12.50 mm / 0.5"



MSA	Model	Measuring range	Resolution	Degree of protection	Kg
15.640	DIALTRONOC	12.50 mm 0.5"	0.01 mm 0.0005"	IP54	-
15.641	DIALTRONOC	12.50 mm 0.5"	0.001 mm 0.00005"	IP54	-
15.642	DIALTRONOC	12.50 mm 0.5"	0.001 mm 0.00005"	IP67	-

DIALTRONOC digital dial gauge, Ø 60 mm.

- Measuring force (N) : MSA15.640 + MSA15.641 (0.65 - 0.90) / MSA15.642 (0.70 - 1.40)
- Indication error over measuring range (retractable plunger) MPEE (µm) : MSA15.640 (10 ± 1 digit) / MSA15.641 + MSA15.642 (3)
- Indication error over partial measuring range (over 1 mm) MPEP (µm) : MSA15.640 (8) / MSA15.641 + MSA15.642 (2.6)
- Repeatability of the indication error MPER (µm) : 2.

Standard features :

- Zeroing/Preset
- Data transmission
- Selection mm/inch
- Selection of measuring direction
- Automatic or manual switch-off
- Locking of the measured value.

Advanced features :

- Definition of upper and lower tolerances
- Dynamic Min / Max / Max-Min measurement
- Selection of Ref 1 or Ref 2 (Preset and stored tolerance)
- Multiplication factor
- Locking of the keyboard
- Choice of resolution : 0.01 or 0.001 mm / 0.0005" or 0.00005".

Travel 12.50 mm / 0.5"



Travel 25 mm / 1"

MSA	Model	Measuring range	Resolution	Degree of protection	Kg
15.643	DIALTRONOC	25.00 mm 1"	0.01 mm 0.0005"	IP54	-
15.644	DIALTRONOC	25.00 mm 1"	0.001 mm 0.00005"	IP54	-
15.645	DIALTRONOC	25.00 mm 1"	0.001 mm 0.00005"	IP67	-

DIALTRONOC digital dial gauge, Ø 60 mm.

- Measuring force (N) : MSA15.643 + MSA15.644 (0.65 - 0.90) / MSA15.645 (0.70 - 1.40)

- Indication error over measuring range (retractable plunger) MPEE (µm) : MSA15.643 (10 ± 1 digit) / MSA15.642 + MSA15.643 (4)

- Indication error over partial measuring range (over 1 mm) MPEP (µm) : 2.6

- Repeatability of the indication error MPER (µm) : 2.

Standard features :

- Zeroing/Preset
- Data transmission
- Selection mm/inch
- Selection of measuring direction
- Automatic or manual switch-off
- Locking of the measured value.

Advanced features :

- Definition of upper and lower tolerances
- Dynamic Min / Max / Max-Min measurement
- Selection of Ref 1 or Ref 2 (Preset and stored tolerance)
- Multiplication factor
- Locking of the keyboard
- Choice of resolution : 0.01 or 0.001 mm / 0.0005" or 0.00005".



Travel 50 mm / 2"
Travel 100 mm / 4"
Travel 150 mm / 6"

MSA	Model	Measuring range	Resolution	Degree of protection	Kg
15.646	DIALTRONOC	50.00 mm 2"	0.001 mm 0.00005"	IP54	-
15.647	DIALTRONOC	100.00 mm 4"	0.001 mm 0.00005"	IP54	-
15.648	DIALTRONOC	150.00 mm 6"	0.001 mm 0.00005"	IP54	-

DIALTRONOC digital dial gauge, Ø 60 mm.

- Measuring force (N) : 0.65 - 0.90

- Indication error over measuring range (retractable plunger) MPEE (µm) : MSA15.646 (5) / MSA15.647 (6) / MSA15.648 (10)

- Indication error over partial measuring range (over 1 mm) MPEP (µm) : 3.2

- Repeatability of the indication error MPER (µm) : 2

- Brake valve included to limit the speed of the plunger's descent stroke.

Standard features :

- Zeroing/Preset
- Data transmission
- Selection mm/inch
- Selection of measuring direction
- Automatic or manual switch-off
- Locking of the measured value.

Advanced features :

- Definition of upper and lower tolerances
- Dynamic Min / Max / Max-Min measurement
- Selection of Ref 1 or Ref 2 (Preset and stored tolerance)
- Multiplication factor
- Locking of the keyboard
- Choice of resolution : 0.01 or 0.001 mm / 0.0005" or 0.00005".

SWISSMETROLOGIE



MSA	Measuring range	Resolution	Kg
15.454-25	25.00 mm / 1"	0.001 mm 0.00005"	0.390
15.454-50	50.00 mm / 2"	0.001 mm 0.00005"	0.490

SWISSMETROLOGIE® electronic indicator.

- Maximum permissible errors/Limit deviations :
 - MSA15.454-10 = 0.004 mm
 - MSA15.454-25 = 0.005 mm
 - MSA15.454-50 = 0.006 mm
- Mounting rod Ø 8 mm
- LCD display 10.5 mm
- PRESET and ON/OFF functions
- Measuring modes ABS/DIFF
- Lithium battery 3 V, CR 2032.

Delivered in 1 synthetic case with operating instructions.

Travel 10, 25 or 50 mm / 0.4, 1 or 2"



MSA	Measuring range	Resolution	Kg
15.128	12.50 mm / 0.5"	0.001 mm 0.00005"	0.247

STANDARD GAGE® electronic indicator.

- Maximum permissible error : 0.004 mm
- Repeatability : 0.002 mm
- Mounting rod Ø 8 mm
- LCD display 10.5 mm
- ABS/PRESET, metric/inch, TOL/SETTOL, MAX/MIN and ZERO/ON buttons
- Lithium battery 3 V, CR 2032.

Delivered in 1 synthetic case with operating instructions.

Travel 12.50 mm / 0.5"



MSA	Measuring range	Resolution	Kg
15.160	25.00 mm 1"	0.0001 mm 0.000004"	?
15.161	25.00 mm 1"	0.0001 mm 0.000004"	?
-	-	-	-
15.162	50.00 mm 2"	0.0001 mm 0.000004"	?
15.163	50.00 mm 2"	0.0001 mm 0.000004"	?

SYLVAC® S-DIAL PRO SMART electronic indicator.

- Maximum error : 1 µm
- Repeatability : 0.2 µm
- Mounting rod Ø 8 mm
- Large display with tolerance status indication by colour LED
- Output data : USB - RS232 - Bluetooth
- Three buttons, including the central button with selectable favourite function
- Wide range of functions, including MIN/MAX/DELTA
- Protection class IP51.

Travel 25 or 50 mm / 1 or 2"

Analogue dial gauges.



MSA	Measuring range	Resolution	Kg
15.627	30.00 mm	0.01 mm	0.190

GIROD-TAST® shockproof dial gauge.

- Dial Ø 58 mm.

Travel 30 mm



MSA	Measuring range	Precision	Kg
15.399	10 mm	0.01 mm	0.170

JFK FEINTASTER dial gauge on horizontal support with "Z" adjustable table.

Mitutoyo



MSA	Measuring range	Precision	Ø dial	Kg
15.126	10 mm	0.01 mm	57 mm	0.170

Analogical dial gauge MITUTOYO®.

- Circular scale : 0 - 100
- 1 dial revolution : 1 mm
- Fixing Ø 8 mm
- Carbide insert.

Cylindrical measuring inserts for indicators.

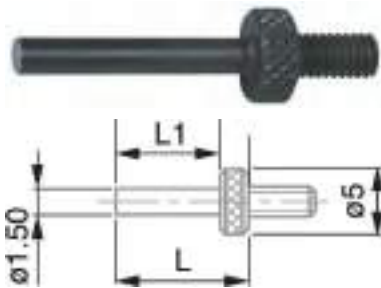

Steel

MSA	\varnothing	Useful length	Kg
15.477	2.00 mm	5.00 mm	0.001
15.417	2.00 mm	10.00 mm	0.001
15.416	2.00 mm	15.00 mm	0.001

Steel cylindrical measuring insert with flat measuring face, M2.5.

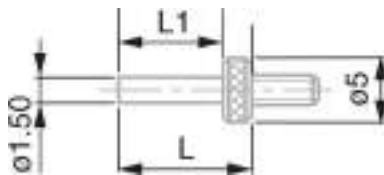

Steel

MSA	\varnothing	Useful length	Kg
15.650	1.50 mm	15.00 mm	0.004
15.651	1.50 mm	20.00 mm	0.004
15.652	1.50 mm	25.00 mm	0.004
15.653	1.50 mm	30.00 mm	0.004

Steel cylindrical measuring insert with flat measuring face, M2.5.

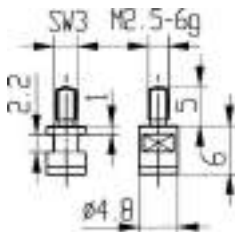

Carbide

MSA	\varnothing	Useful length	Kg
15.654	4.80 mm	6.00 mm	0.004

Carbide cylindrical measuring insert with flat measuring face, M2.5.

Special measuring inserts for indicators.



Steel

MSA	Kg
15.448	-

Steel measuring insert with needle contact point, M2.5.

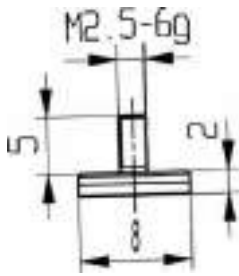

Steel

MSA	∅	Thickness	Useful length	Kg
15.657-08	8.00 mm	2.00 mm	7.00 mm	0.010
15.657-10	10.00 mm	2.00 mm	7.00 mm	0.010
15.657-12	12.00 mm	2.00 mm	7.00 mm	0.010
15.657-15	15.00 mm	2.00 mm	7.00 mm	0.010
15.657-20	20.00 mm	2.00 mm	7.00 mm	0.010
15.657-25	25.00 mm	2.00 mm	7.00 mm	0.010

Steel measuring insert plate-shaped, M2.5.

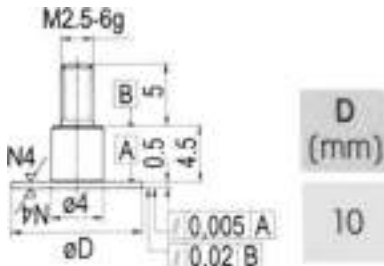

Steel

MSA	∅	Thickness	Kg
15.668	10.00 mm	0.50 mm	0.002

Steel measuring insert plate-shaped, M2.5.

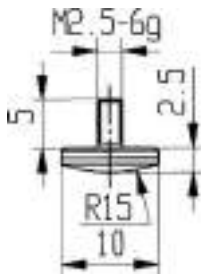

Carbide

MSA	∅	Thickness	Useful length	Kg
15.658	10.00 mm	2.50 mm	7.50 mm	0.002

Carbide domed measuring insert, M2.5.

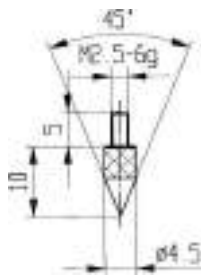

Carbide

MSA	∅	Useful length	Kg
15.659	4.50 mm	10.00 mm	0.002

Carbide conical 45° measuring insert, M2.5.

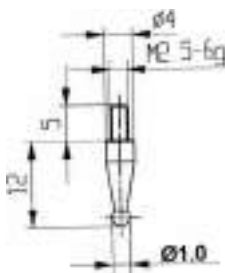

Carbide

MSA	∅	Useful length	Kg
15.660-1.00	1.00 mm	12.00 mm	0.004
15.660-2.00	2.00 mm	12.00 mm	0.004
15.660-3.00	3.00 mm	12.00 mm	0.004

Carbide ball tip measuring insert, M2.5.

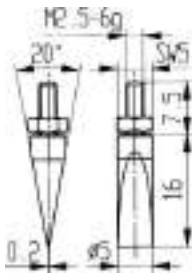

Carbide

MSA	Ø	Useful length	Kg
15.661	5.00 mm	16.00 mm	0.005

Carbide knife-shaped 20° measuring insert, M2.5.

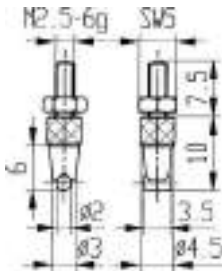

Carbide

MSA	Ø	Useful length	Width	Kg
15.662	2.00 mm	10.00 mm	3.50 mm	0.005

Carbide over wire measuring insert, M2.5.

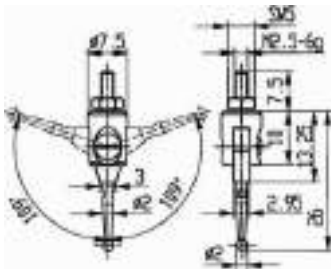

Carbide

MSA	Ø	Useful length	Kg
15.663	2.00 mm	26 mm	0.005

Carbide ball tip measuring insert on articulated pivot, M2.5.

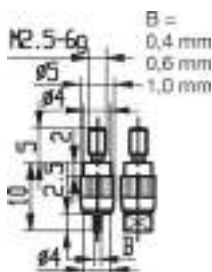

Carbide

MSA	Thickness	Useful length	Width	Kg
15.664	0.40 mm	2.50 mm	2.00 mm	0.005
15.665	0.60 mm	2.50 mm	2.00 mm	0.005
15.666	1.00 mm	2.50 mm	4.00 mm	0.005

Carbide knife-shaped measuring insert, M2.5.

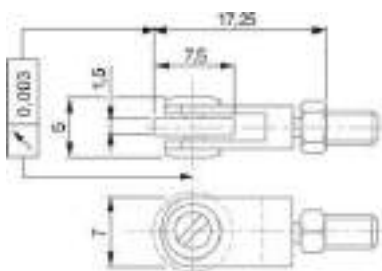

Steel

MSA	Ø	Useful length	Kg
15.667	7.00 mm	17.25 mm	0.005

Steel measuring insert with ball-bearing rollers.

Adapter for vertical dial indicators.

SWISS METROLOGIE



MSA	Size	Kg
15.380	Ø 8 x 35 mm	0.010

Adapter for mounting on a vertical dial indicator. To be used with a plug gauge.

Adapter for interchangeable cylindrical measuring inserts for indicators.

SWISS METROLOGIE



MSA	Kg
15.373	0.002

Adapter for steel interchangeable cylindrical measuring inserts, clamping shank Ø 1.50 mm with tightening screw.

Spare part :

MSA	Item	Kg
15.373-V	Tightening screw	0.001

Interchangeable measuring inserts for indicators.

SWISS METROLOGIE

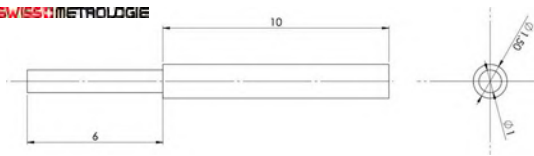

Carbide

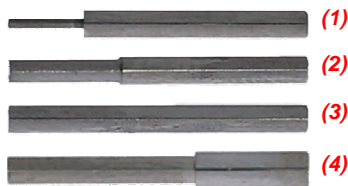

MSA		Ø	Useful length	Total length	Kg
15.358-0.20		0.20 mm	4 mm	16 mm	0.001
15.358-0.30		0.30 mm	4 mm	16 mm	0.001
15.358-0.40		0.40 mm	4 mm	16 mm	0.001
15.358-0.50	(1)	0.50 mm	4 mm	16 mm	0.001
15.358-0.80		0.80 mm	6 mm	16 mm	0.001
15.358-1.00		1.00 mm	6 mm	16 mm	0.001
15.358-1.20	(2)	1.20 mm	6 mm	16 mm	0.001
15.358-1.50	(3)	1.50 mm	16 mm	16 mm	0.001
15.358-2.00	(4)	2.00 mm	10 mm	16 mm	0.001

Carbide interchangeable cylindrical measuring insert with flat measuring face.

SWISS METROLOGIE

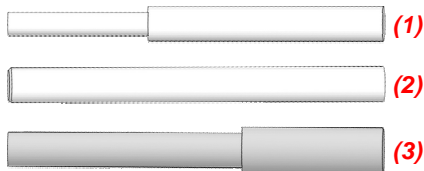

PEEK

MSA		Ø	Useful length	Total length	Kg
15.357-1.00	(1)	1.00 mm	10 mm	16 mm	0.001
15.357-1.50	(2)	1.50 mm	16 mm	16 mm	0.001
15.357-2.00	(3)	2.00 mm	6 mm	16 mm	0.001

PEEK interchangeable cylindrical measuring insert with flat measuring face.

Extensions for measuring inserts.

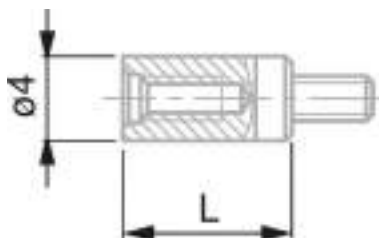

MSA	Ø	Length	Kg
15.359-10	4.00 mm	10 mm	0.002
15.359-15	4.00 mm	15 mm	0.002
15.359-20	4.00 mm	20 mm	0.003
15.359-25	4.00 mm	25 mm	0.004
15.359-30	4.00 mm	30 mm	0.004
15.359-40	4.00 mm	40 mm	0.005
15.359-50	4.00 mm	50 mm	0.006

Extension for measuring inserts, M2.5.

Retraction devices.



MSA	Ø	Kg
15.409	58 mm	0.008

Device for plunger retraction for mounting on the top stem.



MSA	Kg
15.446	-

Device for plunger retraction for mounting on the bottom stem.
Delivered with a lift lever and a washer.



MSA	Kg
15.478	-

Bottom mounted lift lever.
Contains only the retraction lever.



MSA	Ø	Length	Kg
15.407-A	1.50 mm	18 mm	0.001

Flat measuring steel insert with interchangeable pin.



MSA	Kg
15.407-B	0.010

Top lever for plunger retraction.

Vertical measuring supports.



MSA	Ø table	Size	Kg
15.360	50 mm	80 x 130 x 255 mm	2.500
15.361	80 mm	80 x 130 x 255 mm	2.530

Vertical support V 01 type with steel base.
 Measuring capacity 75 mm.
 Delivered with measuring instrument.



MSA	Kg
15.424	2.600

INTERAPID table measuring stand with granite base, grade 00.
 - Measuring range 0 - 170 mm
 - Chrome-plated column Ø 20 mm, tightening Ø 8 mm
 - Measuring table 100 x 150 x 40 mm.
 Delivered without measuring instrument.

Other sizes on request.



MSA	Kg
15.424-B	5.200

Vertical table measuring stand with granite base.
 - Measuring range 0 - 250 mm
 - Chrome-plated column Ø 25 mm, tightening Ø 8 mm
 - Measuring table 150 x 210 x 40 mm.

Other sizes on request.

SWISS METROLOGIE

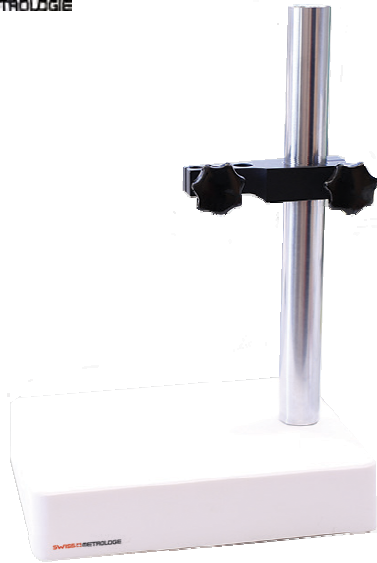

Ceramic

MSA	Size	Kg
15.548	200 x 150 x 40 mm	3.000

Measuring stand with ceramic base.
 - Column height 250 mm
 - Arm length 65 mm.

SWISS METROLOGIE



MSA	Kg
15.558	0.200

Arm with fine setting for measuring stands MSA15.548 and MSA15.549.
 - Centre distance arm 79 mm.

Measuring probes.

HEIDENHAIN



Travel 12 or 25 mm

MSA	Model	Measuring travel	Kg
15.547	MT 1281	12 mm	0.550
15.585	MT 2581	25 mm	0.700

METRO high-precision incremental probe.
 Suitable for measuring stations and control equipments where the precision is important.
 The guided ball-bearing measuring stem allows the absorbing of high transverse loads.
 - Measuring range up to 25 mm
 - Division 4 µm
 - Sinusoidal alternation of amplitude 1 Vcc, signal 2 µm
 - System accuracy ± 0,2 µm
 - Tightening stem Ø 8 mm
 - Interchangeable measuring insert M2.5
 - Cable length 1.5 m
 - Plug connector Sub-D with 15 poles.



Travel 30 mm

MSA	Model	Measuring travel	Kg
15.586	ST 3088	30 mm	0.500

SPECTO high-precision incremental probe. Suitable essentially for multi-measurements working stations and control equipments, thanks to its particularly compact design.

- Measuring range up to 30 mm
- Division 20 µm
- Sinusoidal alternation of amplitude 1 Vcc, signal 20 µm
- System accuracy ± 1 µm
- Tightening stem Ø 8 mm
- interchangeable measuring insert M2.5
- Axial cable length 1.5 m
- Plug connector Sub-D with 15 poles.

Display unit.



MSA	Model	Kg
15.546	M3	0.750

Digital display unit for probe with 2 sensor inputs.

Last generation tool to perform dimensional controls from 1 or 2 probes.

- Equipped with a 4.3" colour touch screen, which allows an easy configuration thanks to the drop down menus, the icons and the functions buttons
- Has different means of communication (USB or RS 232) to transmit measurements to a PC or control the display remotely.

Key features :

- 2 configurations of measurement (2 sides)
- Absolute or relative measurements
- Compatible with inductive and incremental probes
- ASCII communication on Modbus RTU
- Keyboard USB function when the display unit is connected to a PC
- Automatic change of configuration of measurement by probe movement
- Safe and easy to use.

Additional features :

- Different display modes with 1 or 2 sides per screen, with or without tolerances
- Static and dynamic measurement (Min, Max, Max-Min, Average, Median)
- Control limits
- Sorted by grades (up to 16 grades)
- Connection of an optional box with 8 opto-coupled inputs/outputs (MB-IO).

Analogical vertical external micrometres.



MSA	Size	Kg
15.302	85 x 100 x 160 mm	2.800

Vertical micrometre 0-25 mm with table Ø 50 mm.
 Micrometric touch adjuster with non-revolving spindle.
 - Measuring range 0 - 25 mm
 - Precision 0.01 mm.



MSA	Size	Kg
15.303	80 x 130 x 220 mm	2.800

Vertical support V 012 type with perforated table.
 - Measuring capacity 65 mm
 - Micrometric touch adjuster measuring capacity 0 - 25 mm
 - Precision 0.01 mm.

Accessories for analogical vertical external micrometres.



MSA	Ø	Kg
15.369	50 mm	-

Complete table with 25 holes Ø 0.20 - 5.00 mm.

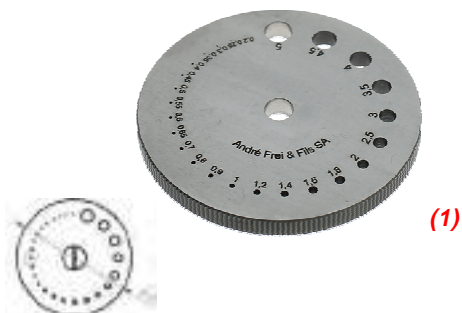

MSA	Ø	Kg
15.370 (1)	50 mm	0.060
15.370-A	50 mm	0.060

Support with 25 holes Ø 0.20 - 5.00 mm.

- Ø 0.20, 0.25, 0.30, 0.35, 0.40, 0.45, 0.50, 0.55, 0.60, 0.65, 0.70, 0.80, 0.90, 1.00, 1.20, 1.40, 1.60, 1.80, 2.00, 2.50, 3.00, 3.50, 4.00, 4.50 and 5.00 mm.

MSA15.370 : with engraving.
 MSA15.370-A : without engraving.

Analogical horizontal external micrometre.

Mitutoyo



MSA	Measuring range	Precision	Kg
15.129	0 - 25 mm	0.001 mm	0.224

Analogical horizontal external counter micrometre MITUTOYO®.
 - Measuring force 5 - 15 N
 - Maximum permissible errors : ± 2 µm
 - Measuring face : Ø 6.50 mm.

Electronic horizontal external micrometres.



(1)

MSA	Measuring range	Degree of protection	Kg
15.431	0 - 30 mm / 0 - 1.2"	IP 40	0.440
15.426	(1) 0 - 30 mm / 0 - 1.2"	IP 54	0.440
15.529	25 - 50 mm / 1 - 2"	IP 54	?

MICROMASTER electronic external micrometre.
 - Precision 0.001 mm or 0.00005"
 - Maximum measuring force 10 N
 - Measuring face Ø 6.50 mm
 - Large easy-to-read LCD display, digit height 7 mm
 - Lithium battery 3 V, CR 2032 - RS 232 interface, opto-coupled.
 Delivered in 1 synthetic case.



5 mm

Ø 2 mm

MSA	Measuring range	Degree of protection	Kg
15.484	0 - 30 mm / 0 - 1.2"	IP 54	0.440

MICROMASTER electronic external micrometre with small measuring faces. For measuring grooves, feather grooves, splines and other difficult-to-reach locations. Small measuring faces specially made to check small precision workpieces.
 - Precision 0.001 mm or 0.00005"
 - Maximum measuring force 10 N
 - Measuring face Ø 2 mm, length 5 mm
 - Large easy-to-read LCD display, digit height 7 mm
 - Lithium battery 3 V, CR 2032 - RS 232 interface, opto-coupled.
 Delivered in 1 synthetic case.

Micrometre support.



MSA	Kg
15.452	-

Stand for external micrometres up to 300 mm as well as many other hand-held tools.
 -Tilt can be locked using a single bolt
 - Lacquered cast iron base
 - Clamp opening : 16 mm.

Analogue horizontal table micrometre.



MSA	Insert	Table	Size	Kg
15.310	A Ø 2 mm	-	160 x 40 x 65 mm	1.000
15.311	(1) S-A Ø 2 mm	Yes	160 x 40 x 65 mm	0.940

Horizontal micrometre 0 - 25 mm.

Other cylindrical inserts on request.

Accessories for horizontal table micrometres.



MSA	Ø	Kg
15.371	17 mm	0.080

Universal table for horizontal micrometres.

Measuring "C" benches.

SWISS METROLOGIE



MSA	Kg
15.567	1.800

Reclining measuring "C" bench (use with inserts M2.5).

- Measuring capacity 30 mm
- Travel 12 mm
- Measuring force from 0.3 to 1 N
- Lift lever.

Delivered without measuring inserts.

SWISS METROLOGIE



MSA	Insert thickness	Insert useful length	Kg
15.560	1 mm	> 10 mm	1.800
15.561	1.5 mm	> 10 mm	1.800
15.562	2 mm	> 10 mm	1.800
15.563	3 mm	> 10 mm	1.800
15.564	4 mm	> 10 mm	1.800
15.565	5 mm	> 10 mm	1.800
15.566	6 mm	> 10 mm	1.800

Reclining measuring "C" bench with hard metal cylindrical fixed measuring inserts.

- Measuring capacity 30 mm
- Travel 12 mm
- Flatness inserts 0.3 µm maximum
- Parallelism inserts < 1 µm maximum
- Measuring force from 0.3 to 1 N
- Lift lever.

SWISS METROLOGIE



MSA	Insert thickness	Insert useful length	Kg
15.532	0.2 mm	< 5 mm	1.920
15.533	0.3 mm	< 5 mm	1.920
15.534	0.4 mm	< 5 mm	1.920
15.531	0.5 mm	< 5 mm	1.920

Reclining measuring "C" bench with hard metal fixed knife-shaped measuring inserts.

- Measuring capacity 30 mm
- Travel 12 mm
- Flatness inserts 0.3 µm maximum
- Parallelism inserts < 1 µm maximum
- Measuring force from 0.3 to 1 N
- Lift lever.

Horizontal measuring bench for external measurements, can be used with interchangeable measuring inserts CARY® type.

SWISSMETROLOGIE



MONO-BLOCK STRUCTURE

MSA	Kg
15.559	2.100

SWISSMETROLOGIE® horizontal measuring bench.

- Measuring capacity 30 mm
- Travel 12 mm
- Flatness inserts 0.3 µm maximum
- Parallelism inserts < 1 µm maximum
- Measuring force from 0.3 to 1 N
- Lift lever.

Delivered without measuring inserts.

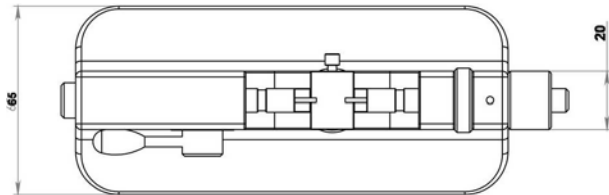
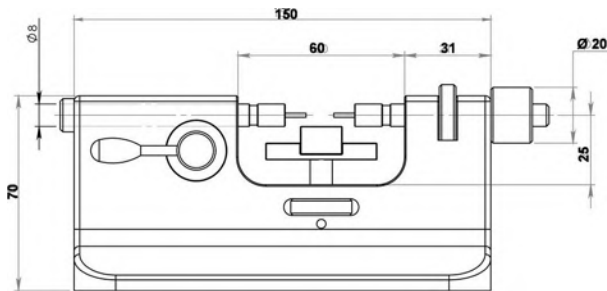
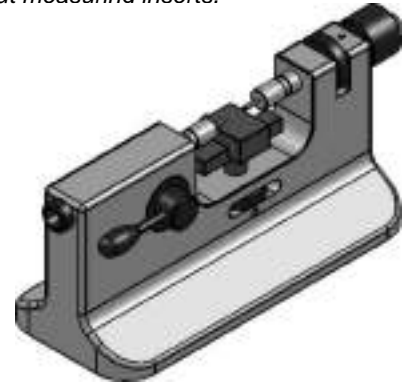

Interchangeable measuring inserts CARY® type.

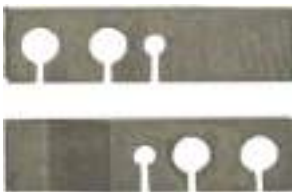

MSA	Thickness	Useful length	Width	Kg
15.550	0.2 mm	< 5 mm	3.50 mm	0.002
15.551	0.3 mm	< 5 mm	3.50 mm	0.002
15.552	0.4 mm	< 5 mm	3.50 mm	0.002
15.553	0.5 mm	< 5 mm	3.50 mm	0.002

Pair of carbide knife-shaped measuring inserts, for MSA15.494 and MSA15.559.

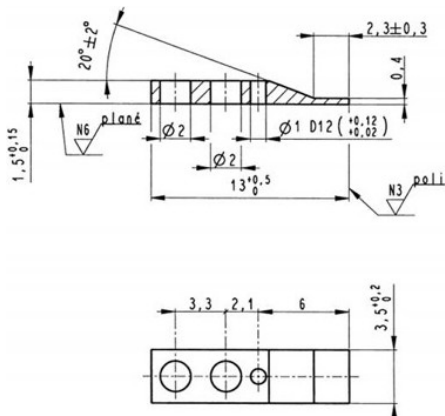

Horizontal measuring bench for **EXTERNAL** measurements, can be used with interchangeable measuring inserts SYLVAC® and CARY® types.

 sylvac



MSA	Measuring range	Resolution	Kg
15.170	0 - 25 mm	0.0001 mm	3.600

SYLVAC® PS16 V2 horizontal measuring bench for external measurements.

- Robust cast iron construction
- With integrated Bluetooth system
- Large display with tolerance status indication by colour LED
- Three buttons, including the central button with selectable favourite function
- Adjustable measuring force 0.1 - 0.6 N
- Protection class IP67.

Delivered with 2 hard metal measuring inserts Ø 1.5 mm.

Accessories : carbide measuring inserts SYLVAC® type, half-knife shaped + table

MSA	Item
15.171-010	Pair of inserts thickness 0.10, usable length 2.20, width 4 mm
15.171-012	Pair of inserts thickness 0.12, usable length 2.20, width 4 mm
15.171-015	Pair of inserts thickness 0.15, usable length 2.20, width 4 mm
15.171-020	Pair of inserts thickness 0.20, usable length 2.20, width 4 mm
15.171-030	Pair of inserts thickness 0.30, usable length 2.20, width 4 mm
15.171-040	Pair of inserts thickness 0.40, usable length 2.20, width 4 mm
15.171-070	Pair of inserts thickness 0.70, usable length 2.20, width 4 mm
15.172	Table "H" shaped with XZ adjustment

Horizontal measuring bench for **INTERNAL** measurements, can be used with interchangeable measuring inserts SYLVAC® and CARY® types.

 sylvac



MSA	Measuring range	Resolution	Kg
15.175	12 - 62 mm	0.0001 mm	5.100

SYLVAC® PS16 V2 LV horizontal measuring bench for internal measurements similar to the MSA15.170, but equipped with a table and anvils assembly allowing to measure internal diameters from Ø 12 to 62 mm.

- Originally designed for measuring watch cases, it is also suitable for measuring rings and thin parts.
- 2-point measurement with positioning of the workpiece in the measuring axis by 2 movable centring pins
- Table height adjustable by up to 20 mm.

Delivered with two 0.4 mm thick measuring inserts.

Horizontal measuring bench for internal measurements.



MSA	Size	Kg
15.574	235 x 110 x 100 mm	-

Internal or external measuring bench H 04 type.
 - Height of the adjustable table from 0 to 20 mm
 - Internal measuring capacity from 5.50 to 65.00 mm
 - External measuring capacity from 1.50 to 60.00 mm
 - Travel 10 mm.

Delivered without indicator.



MSA	Kg
15.575	-

Pair of groove measuring inserts for measuring bench MSA15.574.
 - Internal measuring capacity from 15.50 to 73 mm
 - Thickness 0.25 mm.

Height gauges.



MSA	Measuring range	Degree of protection	Kg
15.491	0 - 100 mm 0 - 4"	IP50	20.000

µHITE 160 height gauge.

Compact design with measuring stand included. The perfect combination for small parts and when a low measuring force is required. The whole system provides the best solution for measuring straightness, flatness and parallelism or inspecting axial and radial runouts, depending on the chosen tool configuration.

Granite measuring table 200 x 300 x 50 mm (W x D x H) ; dull-chrome plated steel column Ø 50 x 300 mm, hardened and ground ; fixing for measuring inserts Ø 6 mm x length 10 mm.

Features :

- Ideal for work piece inspection close to the production area
- Application range from 0 to 160 mm or 0 to 6.3"
- Digital display : 0.001 mm and 0.0001 mm or 0.0001 in and 0.00001"
- Maximum permissible error as low as 2 µm (or 1 µm when checking coaxiality) thanks to the automatic correction of systematic errors by CAA (Computer Aided Accuracy)
- Integrated temperature sensor so that the coefficient of linear expansion of each gauge unit matches that of steel (11,5 x 10⁻⁶ K⁻¹)
- Motorised measuring head for fast probing at each point
- Automatic value capture, controlled over the stability of the measuring force, but also all measured values
- Constant measuring force through the motor-driven actuator. Switchable
- No manual calculation needed
- RS232 data output with direct connection to TESA PRINTER SPC
- Memory capacity for 99 single values.

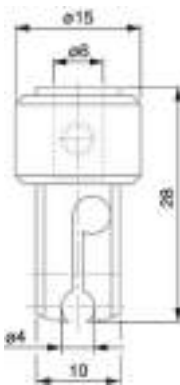

MSA	Kg
15.519	-

Radial probe holder with mounting bore Ø 4 mm.

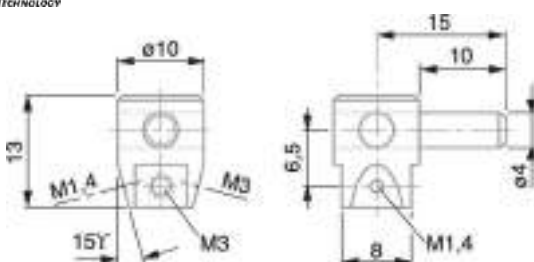

MSA	Kg
15.460	-

Universal probe insert holder with clamping shank Ø 4 mm (to be used with radial probe holder MSA15.519).

M1.4 and M3 threads (2x2) for measuring inserts.



MSA	Kg
15.470	-

Foot switch for triggering data transfer or letting a measuring function be repeated.
Jack plug connector, 1.8 m (TESA SPC PRINTER printer - TESATRONIC TT display units).



MSA	Length	Kg
15.488	2 m	-

Standard Sub-D connection cable between TESA PRINTER SPC and measuring instruments TESA- μ HITE, TESA-HITE and TESA MICRO-HITE. Sub-D 9p/m connector.



MSA	Kg
15.498	-

IG-13 probe set for perpendicularity measurement.
Composed of :
- 1 IG-13 electronic probe
- 1 fixing device for IG-13 probe.



MSA	Model	Measuring range	Kg
15.495	350	0 - 520 mm / 0 - 20"	-
15.497	(1) 600	0 - 770 mm / 0 - 30"	-

MICRO-HITE 350 / 600 new height gauge.

This manual 2D height gauge is mainly used in workshops and offers comfortable and accurate positioning, which is very useful during the measurement of small elements.

Thanks to its robustness, this instrument is very reliable and guarantees excellent repeatability and precision under any circumstances, but especially when used with extensions and small probes.

The interchangeable battery makes it possible to easily handle the instrument in places without access to power supply.

Features :

- Rugged nickel plated base with bottom face including 3 resting points finely lapped
- Application range 0 - 520 mm or 0 - 20" (MSA15.495) ; 0 - 825 mm or 0 - 30" (MSA15.497)
- State-of-the-art concept associated with a high-quality design is the fruit of years of experience in the manufacture of electronic height gauges
- Ideal for dimensional inspection close to the manufacturing cell
- Fast, simple and reliable probing of the workpiece or holes, especially
- 2 main gauges available with either a 520 or 770 mm measuring span
- Numerical display to 0.0001, 0.001, 0.01 and 0.1 mm, or equivalent inch units
- Extremely accurate measuring of deviations from length, straightness and perpendicularity due to the automatic correction of the bias errors through CAA (Computer Aided Accuracy)
- Degree of protection IP20
- Maximum permissible errors $2+2L/1000$
- Maximum permissible perpendicularity error : frontal $7 \mu\text{m}$, lateral $7 \mu\text{m}$
- Measuring force $1.6 \pm 0.25 \text{ N}$ (to the triggering point of the seizure)
- Coefficient of linear expansion identical to steel ($11,5 \times 10^{-6} \text{ K}^{-1}$).

2D panel :

- Colour and touch screen
- Simplified measurement in 2D
- Facilitated creation of the control ranges
- Choice of the data management :
 - On USB key (file *.txt)
 - Direct printing on printer
 - Connection to 1 PC for the statistical data management
 - Information results in real time.
- Every height gauge comes with a SCS calibration certificate.

Marbles and steel supports.



MSA	Granite plates size	Kg
15.374	800 x 500 x 100 mm	120.000
15.372	900 x 600 x 100 mm	210.000
15.375	1000 x 630 x 100 mm	260.000
15.376	1200 x 800 x 120 mm	350.000
15.377	1500 x 1000 x 150 mm	680.000

Black granite plate.
Precision grade DIN 876/0.
Delivered with control report.



MSA	Granite plates size	Kg
15.374-S	800 x 500 x 100 mm	-
15.372-S	900 x 600 x 100 mm	-
15.375-S	1000 x 630 x 100 mm	-
15.376-S	1200 x 800 x 120 mm	-
15.377-S	1500 x 1000 x 150 mm	-

Steel support for black granite plates MSA15.37x, respecting the Bessel points.
Working height 900 mm.
Delivered without black granite plate.



MSA	Granite plates size	Kg
15.378	800 x 500 x 100 mm	-

Support cabinet with 3 metal drawers for black granite plates MSA15.37x.
Built based on Bessel points, with anti-slip protection.
Working height 900 mm.
Delivered without black granite plate.

Roughness gauges.



MSA	Size	Kg
15.490	122 x 60 x 62 mm	0.650

RUGOSURF 20.

Portable roughness gauge, robust and versatile. Designed for production environments or inspection of goods.

- Measuring range in the Z-axis of 400 µm (0.0157 in), 16 mm (0.63 in) in the X-axis
- Probe with diamond point 2 µm
- Sturdy metallic base
- Membrane keyboard, degree of protection IP67
- 15 roughness parameters. Each parameter can be activated individually or not. Tolerancing of each parameter value possible
- 2" LCD display, roughness settings and profile after each measurement
- Very simple to use
- Direct display:
 - of all measured values, with tolerance levels
 - of R roughness profile
 - the Bearing Area Curve (BAC)
 - the Amplitude Distribution Curve (ADC)
- Flexible autonomy through mains adapter or battery pack
- Storage of the measured parameters
- Multilingual menu options
- USB cable connection (optional)
- Direct printing to a dot matrix printer (optional)
- Measurement transfer, database creation and reporting available using TESA RUGOSOFT software tool (optional)
- Access to narrow and hard to reach locations possible through 100 mm probe extension (optional).



MSA	Size	Kg
15.492	270 x 140 x 90 mm	3.000

RUGOSURF 90G.

Small-size, versatile roughness gauge with tactile colour screen providing maximum ease of use. Ideally suited for high-precision measurements on the shop floor or in the inspection laboratory

- Measuring range in the Z-axis of 1000 µm (0.0394 in), 50 mm (0.1.968 in) in the X-axis
- W ripple profiles, P primary profile and R roughness profile measuring
- Tactile TFT 3.5" colour screen
- 3-position horizontal measurement at -90 °, 0 °, 90 °
- 49 roughness parameters
- Delivered with a 2-in-1 special probe with removable pad : one single probe can be used to measure roughness or undulation
- Vertical adjusting screw for probe positioning up to a height of 90 mm without the need of an accessory
- Tolerance of all parameters possible
- USB digital output for transfer of measured values to a PC with TESA MEASUREMENT STUDIO software (optional).

16



ARKANSAS STONES

16 - 2

INDIA STONES

16 - 3

ASSORTMENT OF ARKANSAS AND INDIA STONES

16 - 4

DEGUSSIT STONES

16 - 5

SYNTHETIC STONES

16 - 7

BORAZON GRINDING-WHEELS

16 - 8



ARKANSAS STONES

The Arkansas natural stones are very hard and finer than all other synthetic stones on the market. Colour can be from white to black.



MSA	Size	Kg
16.001	100 x 6 mm	0.013
16.002	100 x 8 mm	0.022
16.003	100 x 10 mm	0.027
16.004	100 x 12 mm	0.043
16.007	100 x 13 mm	0.050
16.006	150 x 16 mm	0.110

Square Arkansas stone.



MSA	Size	Kg
16.010	100 x 4 mm	0.007
16.011	100 x 6 mm	0.008
16.012	100 x 8 mm	0.013
16.013	100 x 10 mm	0.017

Triangular Arkansas stone.



MSA	Size	Kg
16.020	100 x 6 mm	0.010
16.021	100 x 8 mm	0.018
16.022	100 x 10 mm	0.024
16.023	100 x 12 mm	0.030

Round Arkansas stone.



MSA	Size	Kg
16.029	70 x 50 x 25 mm	0.220
16.008	100 x 25 x 6 mm	0.060
16.030	120 x 50 x 25 mm	0.388

Rectangular Arkansas stone.



MSA	Ø	Size	Kg
16.040	6 mm	75-100 mm	0.013

Conical Arkansas stone.



MSA	Size	Kg
16.041	100 x 25 x 4/1.40 mm	0.032

Knife shaped Arkansas stone.



MSA	Size	Ø hole	Kg
16.043	Ø 80 x 10 mm	6 mm	0.150

Spare part :

MSA	Item	Kg
16.042	Arkansas stone wheel shaped, Ø 40 x 5 mm, hole Ø 6 mm	0.023

Wheel shape Arkansas stone.



MSA	Size	Kg
16.050	90 x 25 x 15 mm	0.111
16.049	100 x 25 x 13 mm	0.128
16.051	100 x 40 x 13 mm	0.198
16.052	125 x 50 x 10 mm	0.250
16.053	150 x 50 x 10 mm	0.320

Rectangular Arkansas stone.
Delivered in 1 wooden box.

The authentic India oil stones are artificial stones made of abrasives that are chemically altered in an electric oven at high temperatures.

Main advantages : rapid biting, highly resistant, homogeneity and permanent shape.

Anywhere a grinding stone or truing stone is needed the India stone can be used.



MSA	Grain	Size	Kg
16.100-A	Coarse	100 x 6 mm	0.015
16.101-A	Coarse	100 x 8 mm	0.025
16.102-A	Coarse	100 x 10 mm	0.030
16.103-A	Coarse	100 x 13 mm	0.050
16.105-A	Coarse	150 x 13 mm	0.080
16.104-A	Coarse	150 x 16 mm	0.100
16.100-B	Medium	100 x 6 mm	0.015
16.101-B	Medium	100 x 8 mm	0.025
16.102-B	Medium	100 x 10 mm	0.030
16.103-B	Medium	100 x 13 mm	0.050
16.105-B	Medium	150 x 13 mm	0.080
16.104-B	Medium	150 x 16 mm	0.100
16.100-C	Fine	100 x 6 mm	0.015
16.102-C	Fine	100 x 10 mm	0.030
16.103-C	Fine	100 x 13 mm	0.050
16.105-C	Fine	150 x 13 mm	0.080
16.104-C	Fine	150 x 16 mm	0.100

Square India stone. Coarse, medium or fine grains.



MSA	Grain	Size	Kg
16.110-A	Coarse	100 x 6 mm	0.010
16.112-A	Coarse	100 x 10 mm	0.015
16.110-B	Medium	100 x 6 mm	0.010
16.111-B	Medium	100 x 8 mm	0.012
16.112-B	Medium	100 x 10 mm	0.015
16.110-C	Fine	100 x 6 mm	0.010
16.112-C	Fine	100 x 10 mm	0.015
16.113-C	Fine	100 x 13 mm	0.025

Triangular India stone. Coarse, medium or fine grains.



MSA	Grain	Size	Kg
16.140-B	Medium	150 x 25 x 8/2 mm	0.060

Knife shaped India stone. Medium or fine grains.



MSA	Grain	Size	Kg
16.120-A	Coarse	100 x Ø 6 mm	0.013
16.122-A	Coarse	100 x Ø 10 mm	0.022
16.123-A	Coarse	100 x Ø 13 mm	0.040
16.120-B	Medium	100 x Ø 6 mm	0.013
16.121-B	Medium	100 x Ø 8 mm	0.018
16.122-B	Medium	100 x Ø 10 mm	0.022
16.123-B	Medium	100 x Ø 13 mm	0.040
16.120-C	Fine	100 x Ø 6 mm	0.013
16.122-C	Fine	100 x Ø 10 mm	0.022
16.123-C	Fine	100 x Ø 13 mm	0.040

Round India stone. Coarse, medium or fine grains.



MSA	Grain	Size	Kg
16.132-A	Coarse	150 x 50 x 25 mm	0.495
16.130-B	Medium	100 x 25 x 6 mm	0.045
16.132-B	Medium	150 x 50 x 25 mm	0.526
16.130-C	Fine	100 x 25 x 6 mm	0.045
16.131-C	Fine	125 x 50 x 16 mm	0.285
16.132-C	Fine	150 x 50 x 25 mm	0.495

Rectangular India stone. Coarse, medium or fine grains.



MSA	Size	Kg
16.150	100 x 45 x 16 mm	0.180
16.151	125 x 50 x 20 mm	0.360
16.152	150 x 50 x 25 mm	0.495

Rectangular India stone with 2 grains, coarse and fine.

ASSORTMENT OF ARKANSAS AND INDIA STONES

Assortments of stones ARKANSAS and INDIA.



ASSORTMENT

MSA	Size	Kg
16.201	220 x 63 x 44 mm	0.800

Assortment of 2 rectangular stones.
Delivered in 1 ash wood box.

Contents :
 - 1x MSA16.029 ARKANSAS stone 70 x 50 x 25 mm
 - 1x MSA16.151 INDIA stone 125 x 50 x 20 mm, coarse/fine grain
 - 1x MSA16.201-A Ash wood box



MSA	Size	Kg
16.203	200 x 55 x 30 mm	0.296

Wooden base with 1 ARKANSAS stone for sharpening screwdrivers.
For use with tool MSA01.500.

Contents :
 - 1x MSA16.006 Square ARKANSAS stone 150 x 16 mm
 - 1x MSA16.202 Wooden base



MSA	Size	Kg
16.204	200 x 55 x 30 mm	0.272

Wooden base with 1 INDIA stone for sharpening screwdrivers.
For use with tool MSA01.500.

Contents :
 - MSA16.104-B Square INDIA stone 150 x 16 mm, medium grain
 - MSA16.202 Wooden base

See chapter 01.



The Degussit tools are made of ceramic oxide into polycrystalline exceptionally hard. The addition of chromic oxide gives to the tools a characteristic red coloured and a crystalline structure of rubies.

Main advantages : extremely high hardness, highly resistant, excellent stability of shapes and forms, excellent surface quality and economic tooling of hard materials.

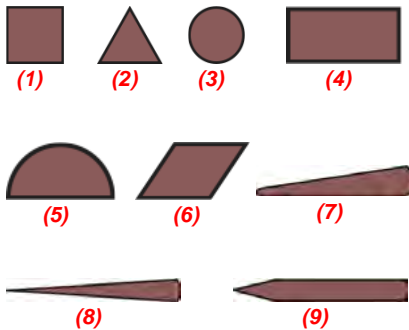

MSA	Grain	Size mm	Shape	MSA	Grain	Size mm	Shape
16.541-A (1)	Coarse	100x6	Square	16.500-B (4)	Medium	100x25x10	Rectang.
16.542-A (1)	Coarse	100x8	Square	16.520-B (4)	Medium	100x25x10	Rectang.
16.543-A (1)	Coarse	100x10	Square	16.521-B (4)	Medium	120x50x10	Rectang.
16.544-A (1)	Coarse	120x13	Square	16.501-B (4)	Medium	150x25x15	Rectang.
16.531-A (2)	Coarse	100x6	Triang.	16.502-B (4)	Medium	200x50x12	Rectang.
16.532-A (2)	Coarse	100x8	Triang.	16.522-B (4)	Medium	200x50x12	Rectang.
16.533-A (2)	Coarse	100x10	Triang.	16.560-B (5)	Medium	100x10	Half-Round
16.534-A (2)	Coarse	120x13	Triang.	16.610-B (7)	Medium	100x15x3/0.	Knife
16.601-A (3)	Coarse	100xØ6	Round	16.510-B (7)	Medium	100x30x7/2	Knife
16.602-A (3)	Coarse	100xØ8	Round	16.540-C (1)	Fine	100x4	Square
16.603-A (3)	Coarse	100xØ10	Round	16.541-C (1)	Fine	100x6	Square
16.551-A (4)	Coarse	100x8x6	Rectang.	16.542-C (1)	Fine	100x8	Square
16.500-A (4)	Coarse	100x25x10	Rectang.	16.543-C (1)	Fine	100x10	Square
16.520-A (4)	Coarse	100x25x10	Rectang.	16.544-C (1)	Fine	120x13	Square
16.501-A (4)	Coarse	150x25x15	Rectang.	16.530-C (2)	Fine	100x4	Triang.
16.560-A (5)	Coarse	100x10	Half-Round	16.531-C (2)	Fine	100x6	Triang.
16.570-A (6)	Coarse	100x13x5	Lozenge	16.532-C (2)	Fine	100x8	Triang.
16.580-A (8)	Coarse	100x5x2	Conical	16.533-C (2)	Fine	100x10	Triang.
16.540-B (1)	Medium	100x4	Square	16.534-C (2)	Fine	120x13	Triang.
16.541-B (1)	Medium	100x6	Square	16.600-C (3)	Fine	100xØ4	Round
16.542-B (1)	Medium	100x8	Square	16.601-C (3)	Fine	100xØ6	Round
16.543-B (1)	Medium	100x10	Square	16.602-C (3)	Fine	100xØ8	Round
16.544-B (1)	Medium	120x13	Square	16.603-C (3)	Fine	100xØ10	Round
16.530-B (2)	Medium	100x4	Triang.	16.550-C (4)	Fine	100x6x3	Rectang.
16.531-B (2)	Medium	100x6	Triang.	16.551-C (4)	Fine	100x8x6	Rectang.
16.532-B (2)	Medium	100x8	Triang.	16.500-C (4)	Fine	100x25x10	Rectang.
16.533-B (2)	Medium	100x10	Triang.	16.520-C (4)	Fine	100x25x10	Rectang.
16.534-B (2)	Medium	120x13	Triang.	16.521-C (4)	Fine	120x50x10	Rectang.
16.600-B (3)	Medium	100xØ4	Round	16.501-C (4)	Fine	150x25x15	Rectang.
16.601-B (3)	Medium	100xØ6	Round	16.502-C (4)	Fine	200x50x12	Rectang.
16.602-B (3)	Medium	100xØ8	Round	16.522-C (4)	Fine	200x50x12	Rectang.
16.603-B (3)	Medium	100xØ10	Round	16.610-C (7)	Fine	100x15x3/0.	Knife
16.550-B (4)	Medium	100x6x3	Rectang.	16.580-C (8)	Fine	100x5x2	Conical
16.551-B (4)	Medium	100x8x6	Rectang.	16.590-C (9)	Fine	100xØ5	Pencil

Degussit stone. Coarse, medium or fine grains.

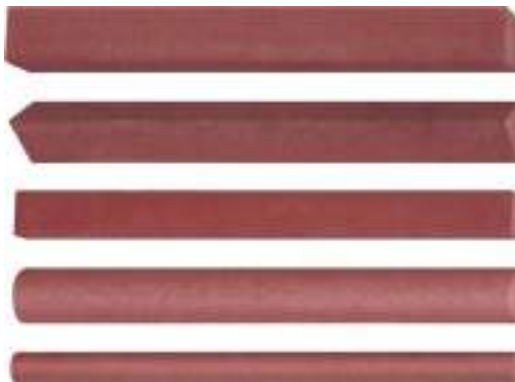

ASSORTMENT

MSA	Packaging size	Kg
16.620	130 x 110 x 30 mm	0.152

Assortment of 5 Degussit stones, length 100 mm.
Grains : fine (rectangular), medium (square, triangular and round) and coarse (half-round).
Delivered in a cardboard box.

DEGUSSIT STONES

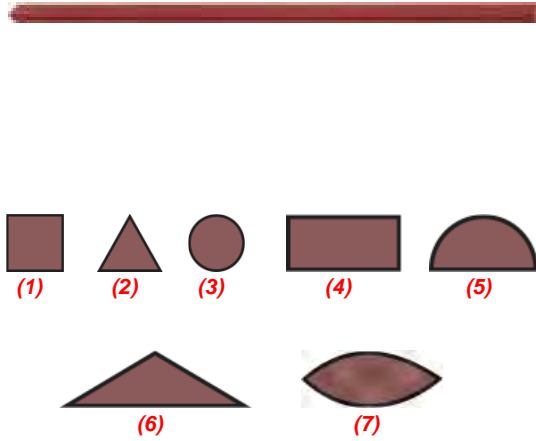

MSA		Size	Shape	Kg
16.630-C	(1)	50 x 1 mm	Square	0.001
16.631-C	(1)	100 x 2 mm	Square	0.003
16.632-C	(2)	50 x 2 mm	Triangular	0.001
16.633-C	(2)	100 x 3 mm	Triangular	0.003
16.634-C	(3)	50 x Ø 1 mm	Round	0.001
16.635-C	(3)	100 x Ø 2 mm	Round	0.001
16.636-C	(3)	100 x Ø 3 mm	Round	0.003
16.636-M	(3)	100 x Ø 2.3 mm	Round	0.003
16.637-C	(4)	50 x 3 x 0.3 mm	Rectangular	0.001
16.638-C	(5)	100 x 4 mm	Half-Round	0.003
16.639-C	(6)	100 x 5 x 1.5 mm	Barrette	0.002
16.640-C	(7)	100 x 4 x 1.5 mm	Sage Leaf	0.003

Degussit stone small file type, Fine grain.



MSA		Packaging size	Kg
16.641		125 x 18 x 15 mm	0.039

Assortment of 12 Degussit stones small file type, length 50 and 100 mm.
Delivered with 1 stone holder tool in a plastic box.

Spare part :

MSA	Item	Kg
16.642	Stone holder tool	0.020



MSA	Length	Head size	Kg
16.670-C	150 mm	35 x 14 x 5 mm	0.047

Degussit stone sharpener, mounted on handle. Fine grain.

Synthetic stones are used for finishing and precise retouching on metal pieces.



ASSORTMENT

MSA	Stones size	Packaging size	Kg
16.155	100 x 4 x 4 mm	165 x 35 x 35 mm	0.080

Assortment of 13 synthetic abrasive stones.

Spare parts :

MSA	Item	Kg
16.155-0030	Abrasive stone D320	0.005
16.155-0060	Abrasive stone D600	0.005
16.155-0090	Abrasive stone D900	0.005
16.155-0100	Abrasive stone MED INDIA	0.005
16.155-0120	Abrasive stone SF1200	0.005
16.155-0430	Abrasive stone RA320	0.005
16.155-0460	Abrasive stone RA600	0.004
16.155-1020	Abrasive stone MP220	0.005
16.155-1040	Abrasive stone MP400	0.005
16.155-1060	Abrasive stone MP600	0.005
16.155-1080	Abrasive stone MP800	0.005
16.155-1200	Abrasive stone MP1200	0.005
16.155-4080	Abrasive stone D1200	0.005

Electrolytic Borazon grinding-wheels.



MSA		Grain	Kg
16.800	(1)	B126 coarse	0.007
16.801	(2)	B91 medium	0.007
16.802	(3)	B76 fine	0.007

Electrolytic Borazon grinding-wheel.

*To be mounted on the device for forming screwdriver blades MSA01.505.
See chapter 01 / TOOLS FOR SHAPING AND SHARPENING BLADES.*

17



OILERS

17 - 2

OIL CUPS

17 - 6

PACKAGING

17 - 8

Simple oilers : the flat metallic needle of the oiler allows precise oiling of all parts of the movement.



ASSORTMENT

MSA	Kg
17.000-04	0.016

Assortment of 4 simple oilers with protective caps. Aluminium handle Ø 6 mm, colour coded for easy identification of the spatula width.

Contents : MSA17.000-A, -C, -D and -E.



INDIVIDUAL

MSA	Colour	Length	Needle	Kg
17.000-A	Red	70 mm	Large	0.004
17.000-C	Green	70 mm	Medium	0.004
17.000-D	Blue	70 mm	Fine	0.004
17.000-E	Black	70 mm	Very fine	0.004

Simple oiler with aluminium handle Ø 6 mm. See assortment MSA17.000-04.



ASSORTMENT

MSA	Kg
17.001-04	0.006

Assortment of 4 simple oilers with protective caps. Plastic handle Ø 6 mm, colour coded for easy identification of the spatula width.

Contents : MSA17.001-A, -C, -D and -E.



INDIVIDUAL

MSA	Colour	Length	Needle	Kg
17.001-A	Red	70 mm	Large	0.001
17.001-C	Green	70 mm	Medium	0.001
17.001-D	Blue	70 mm	Fine	0.001
17.001-E	Black	70 mm	Very fine	0.001

Simple oiler with plastic handle Ø 6 mm. See assortment MSA17.001-04.





ASSORTMENT

MSA	Kg
17.002-04	0.008

Assortment of 4 oilers with interchangeable needles and protective caps. Plastic handle Ø 6 mm, colour coded for easy identification of the spatula width, with 2 replacement needles inside each handle.

Contents : MSA17.002-A, -C, -D and -E.



INDIVIDUAL

MSA	Colour	Length	Needle	Kg
17.002-A	Red	72 mm	Large	0.002
17.002-C	Green	72 mm	Medium	0.002
17.002-D	Blue	72 mm	Fine	0.002
17.002-E	Black	72 mm	Very fine	0.002

Oiler with plastic handle Ø 6 mm with 2 replacement needles inside. See assortment MSA17.002-04.

Spare parts :

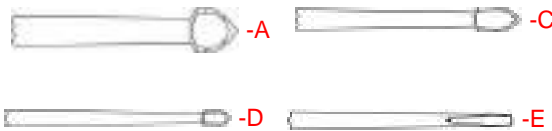

MSA	Item	Kg
17.002P-A	Needle for MSA17.002-A	0.001
17.002P-C	Needle for MSA17.002-C	0.001
17.002P-D	Needle for MSA17.002-D	0.001
17.002P-E	Needle for MSA17.002-E	0.001



ASSORTMENT

MSA	Kg
17.102-04	0.006

Assortment of 4 simple oilers with protective caps. Plastic handle Ø 5 mm, colour coded for easy identification of the spatula width.

Contents : MSA17.102-D, -C, -B and -A.

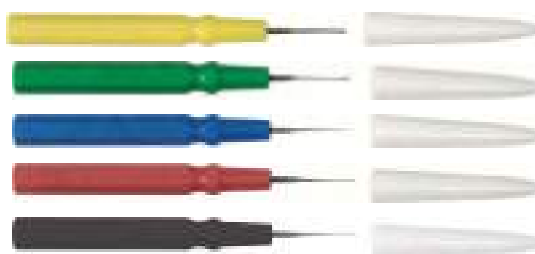

INDIVIDUAL

MSA	Colour	Length	Needle	Kg
17.102-D	Yellow	70 mm	Very large	0.001
17.102-C	Green	70 mm	Large	0.001
17.102-B	Blue	70 mm	Medium	0.001
17.102-A	Red	70 mm	Fine	0.001
17.102-E	Black	70 mm	Fine	0.001

Simple oiler with plastic handle Ø 5 mm. See assortment MSA17.102-04.

Spare parts :

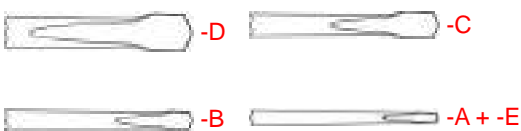

MSA	Item	Kg
17.102P-D	Needle for MSA17.102-D	0.001
17.102P-C	Needle for MSA17.102-C	0.001
17.102P-B	Needle for MSA17.102-B	0.001
17.102P-A	Needle for MSA17.102-A and MSA17.102-E	0.001

OILERS



ASSORTMENT

MSA	Kg
17.101-04	0.006

Assortment of 4 simple oilers with protective caps.
Plastic handle Ø 5 mm, colour coded for easy identification of the spatula width.
Contents : MSA17.101-A, -B, -C and -D.



INDIVIDUAL



MSA	Colour	Length	Needle	Kg
17.101-A	● Black	70 mm	Fine	0.001
17.101-B	● Blue	70 mm	Medium	0.001
17.101-C	● Green	70 mm	Large	0.001
17.101-D	● Red	70 mm	Very large	0.001

Simple oiler with antistatic plastic handle Ø 5 mm.



MSA	Length	Kg
17.003	70 mm	0.004

Precision Incabloc oiler, with aluminium gilt handle Ø 6 mm and 3 replacement needles inside.

Spare part :

MSA	Item	Kg
17.003-01	Needle	0.001



Oilers.



MSA	Colour	Needle internal Ø	Needle external Ø	Kg
17.050	Pink	0.12 mm	0.30 mm	0.040
17.051	Cream	0.15 mm	0.35 mm	0.040
17.052	Dark blue	0.17 mm	0.42 mm	0.040

JISMAA oiler for escapement and pallet forks.

Delivered with 1 stand.

Use with JISMAA oils recommended (see chapter 28).

Spare parts :

MSA	Item	Kg
17.050-R	Oil container for MSA17.050	0.001
17.051-R	Oil container for MSA17.051	0.001
17.052-R	Oil container for MSA17.052	0.001



MSA	Colour	Needle internal Ø	Needle external Ø	Kg
17.060	Matt red	0.10 mm	0.30 mm	0.040
17.061	Black	0.15 mm	0.38 mm	0.040
17.062	Light blue	0.20 mm	0.45 mm	0.040
17.063	Purple	0.30 mm	0.55 mm	0.040

JISMAA oiler for gear train and cap jewels.

Delivered with 1 stand.

Use with JISMAA oils recommended (see chapter 28).

Spare parts :

MSA	Item	Kg
17.060-R	Oil container for MSA17.060	0.001
17.061-R	Oil container for MSA17.061	0.001
17.062-R	Oil container for MSA17.062	0.001
17.063-R	Oil container for MSA17.063	0.001



MSA	Volume	Size	Kg
17.210	6 cc	Ø 13 x 155 mm	0.028

Lubristyl® precision oil pen, pen shape.

Drop by drop lubricant dispenses thanks to the needle pump. Possibility to easily re-absorb the extra oil by briefly and rapidly pushing the needle.

Delivered with 6 cc oil.

Spare part :

MSA	Item	Kg
17.210-100	Oil refill, 100 ml	0.113



OIL CUPS



MSA	Size	Kg
17.106	145 x 45 x 25 mm	?

Assortment of 4 anodized aluminium oil cups with ceramic cups.
The oil cups can be used individually and can also be inserted on the base plate.

Contents :

- MSA17.105-P : anodised grey aluminium base plate
- MSA17.105-01 : anodised red aluminium oil cup
- MSA17.105-02 : anodised blue aluminium oil cup
- MSA17.105-03 : anodised green aluminium oil cup
- MSA17.105-04 : anodised yellow aluminium oil cup.

Spare parts :



MSA	Item	Kg
17.105-01	Anodised red aluminium oil cup with base and cover, Ø 25 x height 13.90 mm, white ceramic cup Ø 14.50 x height 3 mm, well Ø 6 mm	?
17.105-02	Anodised blue aluminium oil cup with base and cover, Ø 25 x height 13.90 mm, white ceramic cup Ø 14.50 x height 3 mm, well Ø 8 mm	?
17.105-03	Anodised green aluminium oil cup with base and cover, Ø 25 x height 13.90 mm, white ceramic cup Ø 14.50 x height 3 mm, well Ø 9 mm	?
17.105-04	Anodised yellow aluminium oil cup with base and cover, Ø 25 x height 13.90 mm, white ceramic cup Ø 14.50 x height 3 mm, well Ø 10 mm	?
17.105-P	Aluminium base plate, 145 x 45 x 8 mm	?



MSA	Size	Kg
17.103	95 x 60 x 65 mm	0.275

Complete aluminium oil cup.

Contents :

- Shot blasted aluminium base, grey anodized
 - 4 white ceramic cups
 - 4 oilers with aluminium handle Ø 6 mm in different colours.
- The cups can be replaced individually.

Spare parts :

MSA	Item	Kg
17.000-A	Red oiler with large needle, length 70 mm	0.004
17.000-C	Green oiler with medium needle, length 70 mm	0.004
17.000-D	Blue oiler with fine needle, length 70 mm	0.004
17.000-E	Black oiler with very fine needle, length 70 mm	0.004
17.103-01	Cup Ø ext. 14.50 x height 3 mm, well Ø 6 mm	0.003
17.103-02	Cup Ø ext. 14.50 x height 3 mm, well Ø 8 mm	0.003
17.103-03	Cup Ø ext. 14.50 x height 3 mm, well Ø 9 mm	0.003
17.103-04	Cup Ø ext. 14.50 x height 3 mm, well Ø 10 mm	0.003



MSA	Size	Kg
17.104	95 x 60 x 65 mm	0.275

Complete aluminium oil cup.

Contents :

- Shot blasted aluminium base, grey anodized
 - 4 synthetic ruby cups
 - 4 oilers with aluminium handle Ø 6 mm in different colours.
- The cups can be replaced individually.

Spare parts :

MSA	Item	Kg
17.000-A	Red oiler with large needle, length 70 mm	0.004
17.000-C	Green oiler with medium needle, length 70 mm	0.004
17.000-D	Blue oiler with fine needle, length 70 mm	0.004
17.000-E	Black oiler with very fine needle, length 70 mm	0.004
17.104-01	Cup Ø ext. 14.50 x height 3 mm, well Ø 6 mm	0.003
17.104-02	Cup Ø ext. 14.50 x height 3 mm, well Ø 8 mm	0.003
17.104-03	Cup Ø ext. 14.50 x height 3 mm, well Ø 9 mm	0.003
17.104-04	Cup Ø ext. 14.50 x height 3 mm, well Ø 10 mm	0.003



MSA	Size	Kg
17.201	83 x 40 x 26 mm	0.100

Four-oil cup chrome-plated stand allowing the deposit of oils and grease.

The complete set is chromes and includes :

- 4 cups in anti-hygrometric glass
 - 1 mobile black plastic lid to protect oil from dust
 - 3 holes filled with pith wood for cleaning the oilers
 - 1 groove for oiler storage
 - 1 anti-skid rubber sole to ensure a good stability.
- Delivered without oilers.



MSA	External Ø	Internal Ø	Kg
17.100	40 mm	25 mm	0.055

Fluted glass oil cup.

Stackable boxes and lids for watch after sales service.



MSA	Colour	Size	Kg
17.527-B	Blue	236 x 105 x 17 mm	0.095
17.527-J	Yellow	236 x 105 x 17 mm	0.095
17.527-R	Red	236 x 105 x 17 mm	0.095
17.527-V	Green	236 x 105 x 17 mm	0.095
17.527-W	White	236 x 105 x 17 mm	0.095

Plastic container with 6 compartments.
 - 5 compartments 49 x 44 x 15 mm
 - 1 compartment 49 x 44 x 15 mm.
 ATTENTION : lid sold separately.



MSA	Colour	Size	Kg
17.530-B	Blue	236 x 105 x 17 mm	0.104
17.530-J	Yellow	236 x 105 x 17 mm	0.104
17.530-R	Red	236 x 105 x 17 mm	0.104
17.530-V	Green	236 x 105 x 17 mm	0.104

Plastic container with 10 compartments.
 - Compartments 49 x 44 x 15 mm.
 ATTENTION : lid sold separately.



MSA	Size	Kg
17.528 (1)	246 x 112 x 20 mm	0.090
17.572 (2)	246 x 112 x 20 mm	0.102

Transparent lid with stacking cam for plastic containers MSA17.527-x and MSA17.530-x.

(1) With locking holes
 (2) Without locking holes



MSA	Colour	Use with	Kg
17.531-1	Black	1 lid + 1 container	0.001
17.531-2	Yellow	1 lid + 2 containers	0.001
17.531-3	Red	1 lid + 3 containers	0.001
17.531-4	Green	1 lid + 4 containers	0.001
17.531-5	Blue	1 lid + 5 containers	0.001

Plastic key (5 colours) allowing to firmly link one or several containers MSA17.527-x and MSA17.530-x.



MSA	Size	Kg
17.532	49 x 41 x 16 mm	0.003

Foam insert for plastic containers MSA 17.527-x and MSA17.530-x.



MSA	Size	Kg
17.532-A	232 x 48 x 15 mm	0.023

Foam insert for plastic containers MSA 17.527-x.

Plastic boxes with elastic membrane box, ideal to protect delicate, round, pointed or deformed objects of different sizes without risk of oxidation.

The transparency of the packaging allows a visual control.

The bottoms and the lids of the boxes are interchangeable and equipped with a thin polyurethane membrane.

The objects stay still and suspended inside the box.



MSA	Size	Kg
17.650	39 x 39 x 18 mm	0.008

Complete membrane plastic box.
Composed of a lower and upper half box.



MSA	Size	Quantity	Kg
17.663 (1)	120 x 79 x 17.80 mm	6	0.046
17.662 (2)	240 x 79 x 17.80 mm	12	0.091

Set of 6 or 12 membrane plastic boxes.
Delivered with 1 bottom and 1 lid.
Exterior size of one box : 39 x 39 x 17.8 mm.



MSA	Size	Kg
17.677 (1)	34 x 34 x 25 mm	0.014
17.678 (2)	50 x 50 x 25 mm	0.032

Complete membrane plastic box.
Composed of a lower and upper half box, hinge and lockers.



MSA	Size	Kg
17.682	100 x 100 x 40 mm	0.085

Complete membrane plastic box.
Composed of a lower and upper half box, hinge and lockers.



MSA	Size	Kg
17.664 (1)	Ø 82 x 17 mm	0.020
17.665 (2)	Ø 82 x 40 mm	0.030

Round membrane plastic boxes.
Delivered with 1 bottom and 1 lid.



MSA		Size	Kg
17.684		50 x 50 x 25 mm	0.020
17.653	(1)	100 x 50 x 50 mm	0.044
17.670		100 x 75 x 25 mm	0.054
17.654	(2)	100 x 75 x 50 mm	0.063
17.671		100 x 100 x 25 mm	0.075
17.655	(3)	100 x 100 x 50 mm	0.076
17.676		125 x 125 x 50 mm	0.106
17.672		150 x 100 x 25 mm	0.093
17.656	(4)	150 x 100 x 50 mm	0.103
17.673		150 x 150 x 50 mm	0.148
17.657		150 x 150 x 100 mm	0.177
17.674		200 x 100 x 50 mm	0.133
17.658		200 x 100 x 75 mm	0.141
17.659		200 x 200 x 50 mm	0.238
17.679		250 x 200 x 25 mm	0.343
17.675		250 x 200 x 50 mm	0.343
17.660		250 x 200 x 100 mm	0.375
17.661	(5)	275 x 200 x 200 mm	0.550
17.651		300 x 75 x 25 mm	0.143
17.668		300 x 75 x 50 mm	0.162
17.669		300 x 100 x 50 mm	0.195

Complete membrane plastic box.
Composed of a lower and upper half box, hinge and lockers.

Spare part :

MSA	Item
17.699	Transparent hinge for membrane box. Delivered in bag of 100 pieces

Boxes for spare parts.



MSA	Size	Kg
17.505	260 x 105 x 24 mm	0.260

Plastic box. Black structured bottom and transparent lid with hinges and stacking notches.

Contents :
- 21 cases Ø 24 mm
- 2 cases Ø 40 mm.



MSA	Size	Kg
17.506	260 x 105 x 24 mm	0.266

Plastic box. Black structured bottom and transparent lid with hinges and stacking notches.

Contents :
- 10 cases Ø 24 x 16 mm
- 7 rectangular boxes 44 x 24 x 19 mm
- 2 square boxes 48 x 48 x 20 mm.



MSA	Compartments	Size	Kg
17.564	253 x 97 x 20 mm	260 x 105 x 25 mm	0.148

Plastic box with 1 compartment. Black structured bottom and transparent lid with hinges and stacking notches.



MSA	Compartments	Size	Kg
17.507	49 x 48 x 18 mm	260 x 105 x 25 mm	0.170

Plastic box with 10 compartments. Black structured bottom and transparent lid with hinges and stacking notches.

The following plastic boxes can be inserted : MSA17.503, 17.504 and 17.508.



MSA	External size	Internal size	Kg
17.504	48 x 48 x 20 mm	42 x 42 x 15 mm	0.013

Square plastic box. Transparent bottom and lid.
Can be used as an insert in the plastic box MSA17.507.



MSA	External size	Internal size	Kg
17.503-17	44 x 24 x 17 mm	40 x 20 x 15 mm	0.005
17.503	44 x 24 x 19 mm	40 x 20 x 17 mm	0.006

Rectangular plastic box. Transparent bottom and lid.
Can be used as an insert in the plastic box MSA17.507.



MSA	External size	Internal size	Kg
17.508	23 x 23 x 19 mm	20 x 20 x 17 mm	0.004

Square plastic box. Transparent bottom and lid.
Can be used as an insert in the plastic box MSA17.507.



MSA	Compartments	Size	Kg
17.565	123 x 97 x 20 mm	130 x 105 x 25 mm	0.075

Plastic box 1 compartment. Black bottom and transparent lid with hinges and stacking notches.



MSA	Compartments	Size	Kg
17.567	47 x 23 x 18 mm	130 x 105 x 25 mm	0.080

Plastic box 10 compartments. Black bottom and transparent lid with hinges and stacking notches.



MSA	Compartments	Size	Kg
17.515	55 x 60 x 22 mm	296 x 135 x 32 mm	0.300

Plastic box with 10 compartments. Light blue bottom and transparent lid with hinges and stacking notches.



MSA	Compartments	Size	Kg
17.519	32 x 32 x 9.50 mm	350 x 180 x 16 mm	0.330

Plastic box with 50 compartments. Light blue bottom and transparent lid with hinges and stacking notches.



MSA	Compartments	Size	Kg
17.533	13 x 11 x 4.50 mm	152 x 70 x 11 mm	0.060

Plastic box with 50 compartments. Light blue bottom and transparent lid with hinges and stacking notches.



MSA	Compartments	Size	Kg
17.534	20 x 17.50 x 4.50 mm	220 x 105 x 11 mm	0.130

Plastic box with 50 compartments. Light blue bottom and transparent lid with hinges and stacking notches.



MSA	Compartments	Size	Kg
17.535	31.50 x 17.50 x 4.50 mm	340 x 100 x 11 mm	0.175

Plastic box with 50 compartments. Light blue bottom and transparent lid with hinges and stacking notches.



MSA	Compartments	Size	Kg
17.541	10 x 8 x 4.50 mm	121 x 55 x 11 mm	0.040

Plastic box with 50 compartments. Light blue bottom and transparent lid with hinges and stacking notches.



MSA	Compartments	Size	Kg
17.510	30 x 21 x 8 mm	120 x 70 x 15 mm	0.050

Plastic box with 10 compartments. Light blue bottom and transparent sliding lid with stacking notches.



MSA	Compartments	Size	Kg
17.512	36 x 11 x 18.50 mm	120 x 70 x 25 mm	0.075

Plastic box with 15 compartments. Light blue bottom and transparent sliding lid with stacking notches.



MSA	Compartments	Size	Kg
17.500	50 x 32 x 18 mm	207 x 112 x 23 mm	0.140

Plastic box with 12 compartments. Light grey bottom and transparent lid with hinges and stacking notches.



MSA	Compartments	Size	Kg
17.566	50 x 39 x 18 mm	207 x 112 x 23 mm	0.120

Plastic box 10 compartments. Light grey bottom and transparent lid with hinges and stacking notches.

PACKAGING



MSA	Compartments	Size	Kg
17.501	15 x 33 x 18 mm	207 x 112 x 23 mm	0.140

Plastic box with 36 compartments. Transparent bottom and lid with hinges and stacking notches.

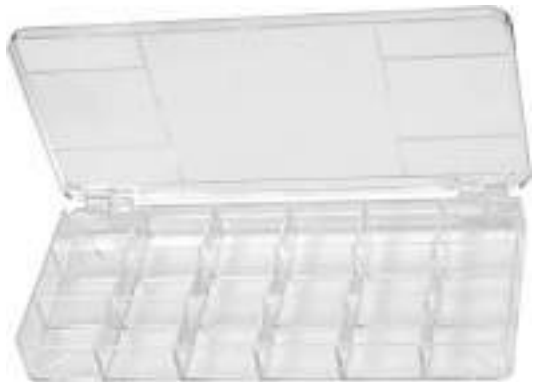

MSA	Compartments	Size	Kg
17.579	33 x 33 x 32 mm	210 x 112 x 35 mm	0.174

Non-stackable plastic box with 18 compartments. Transparent bottom and lid with hinges.



MSA	Compartments	Size	Kg
17.509	46 x 6 x 6 mm	84 x 54 x 16 mm	0.028

Stackable plastic box with 10 compartments. Transparent bottom and lid.



MSA	Compartments	Size	Kg
17.516	22 x 11 x 7 mm	84 x 54 x 16 mm	0.025

Stackable plastic box with 12 compartments. Transparent bottom and lid.



MSA	Compartments	Size	Kg
17.539	75 x 12 x 7 mm	84 x 54 x 16 mm	0.025

Stackable plastic box with 5 compartments. Transparent bottom and lid.



MSA	Compartments	Size	Kg
17.520	10 x 29 x 10 mm	108 x 64 x 13 mm	0.035

Non-stackable plastic box with 18 compartments. Transparent bottom and lid.



MSA	External size	Internal size	Kg
17.522	36 x 26 x 6 mm	31 x 21 x 4 mm	0.003

Non-stackable rectangular plastic box. Transparent bottom and lid.



MSA	Compartments	Size	Kg
17.523	29 x 13 x 14 mm	90 x 64 x 17 mm	0.037

Stackable plastic box with 12 compartments. Yellow bottom and transparent lid with stacking notches.



MSA	External size	Internal size	Kg
17.524	90 x 68 x 21 mm	85 x 61 x 16 mm	0.027

Rectangular plastic box. Transparent bottom and lid.



MSA	External size	Internal size	Kg
17.589	81 x 56 x 19 mm	75x49x16 mm	0.020

Rectangular plastic box. Transparent bottom and lid.



MSA	External size	Internal size	Kg
17.538	88 x 47 x 15 mm	84 x 44 x 11 mm	0.020

Rectangular plastic box. Grey bottom and transparent lid.



MSA	Compartments	Size
17.545	20 x 17,50 x 5 mm	220 x 105 x 11 mm

Non-stackable plastic box with 50 compartments. Light blue bottom and transparent lid, for balances.



MSA	Compartments	Size	Kg
17.571	1x 19 x 19 x 13 mm 6x 20 x 9 x 13 mm	44 x 44 x 16 mm	0.010

Square plastic box with 7 compartments and lid.

PACKAGING



MSA	External size	Internal size	Kg
17.525	Ø 40 x 12 mm	Ø 35 x 9 mm	0.005

Round plastic box. Transparent bottom and lid attached.



1000 pieces

MSA	Size	Quantity	Kg
17.529	Ø 7 x 24 mm	1000	0.100

Transparent packaging capsule.



100 pieces

MSA	External size	Internal size	Kg
17.536	9 x 9 x 23 mm	6 x 6 x 19 mm	0.072

Square plastic tube. Transparent bottom and red lid.



100 pieces

MSA	External size	Internal size	Kg
17.537	9 x 9 x 39 mm	6 x 6 x 35 mm	0.124

Square plastic tube. Transparent bottom and red lid.



1000 pieces

MSA	External size	Internal size	Quantity	Kg
17.542	Ø 7.5 x 33 mm	Ø 6 x 29 mm	1000	3.000

Round transparent plastic tube.

Caps in different colours to be ordered separately. See list below.

1000 pieces



MSA	Colour	Size	Quantity	Kg
17.542-001	Red	Ø 10 x 8 mm	1000	1.000
17.542-002	Light green	Ø 10 x 8 mm	1000	1.000
17.542-003	Yellow	Ø 10 x 8 mm	1000	1.000
17.542-004	Blue	Ø 10 x 8 mm	1000	1.000
17.542-005	Grey	Ø 10 x 8 mm	1000	1.000
17.542-006	White	Ø 10 x 8 mm	1000	1.000
17.542-007	Dark green	Ø 10 x 8 mm	1000	1.000
17.542-008	Dark pink	Ø 10 x 8 mm	1000	1.000
17.542-009	Purple	Ø 10 x 8 mm	1000	1.000
17.542-010	Brown	Ø 10 x 8 mm	1000	1.000
17.542-011	Black	Ø 10 x 8 mm	1000	1.000
17.542-012	Light pink	Ø 10 x 8 mm	1000	1.000

Plastic cap for tube MSA17.542.



MSA	Size	Kg
17.577	Ø 16 x 9 mm	0.001

Round plastic box, transparent bottom and lid.



1000 pieces

MSA	Size	Quantity
17.540-A	Ø 17 x 8 mm	1000
17.540-B	Ø 17 x 12 mm	1000
17.540-C	Ø 22 x 13 mm	1000

Round plastic box, transparent bottom and lid.



100 pieces

MSA	Size	Quantity	Kg
17.807	Ø 24 x 16 mm	100	0.150
17.812	Ø 33 x 16 mm	100	-
17.813	Ø 40 x 16 mm	100	0.580

Round plastic box, transparent bottom and lid.



MSA	Size	Kg
17.801-09	Ø 50 x 35 mm (50 ml)	0.008
17.801-3619 *	Ø 36 x 19 mm (10 ml)	0.006
17.801-5120 *	Ø 51 x 20 mm (30 ml)	0.009

Round aluminium box.

* Screw-on lid



MSA	Size	Kg
17.809	44 x 44 x 17 mm	0.020

Square aluminium box, transparent plastic lid.

PACKAGING



MSA	Calibre	Hole(s) for stem(s)	Quantity	Kg
17.800-01	4 ^{'''}	1	50	0.218
17.800-04	(1) 5 1/2 ^{'''}	1	50	0.149
17.800-06	(2) 6 3/4 ^{'''} x 8 ^{'''}	1	50	0.105
17.800-08	(3) 7 3/4 ^{'''}	1	50	0.120
17.800-10	8 3/4 ^{'''}	1	50	0.137
17.800-12	10 1/2 ^{'''}	1	50	0.161
17.800-13	11 1/2 ^{'''}	1	50	0.215
17.800-02	11 3/4 ^{'''}	4	50	0.187
17.800-14	12 1/2 ^{'''}	1	50	0.265
17.800-18	13 1/4 ^{'''}	1	50	0.158
17.800-15	13 1/2 ^{'''}	1	50	0.345

Plastic case with bottom and lid to protect movements.

Packaging: 50 complete cases (except MSA17.800-17, 1 piece)

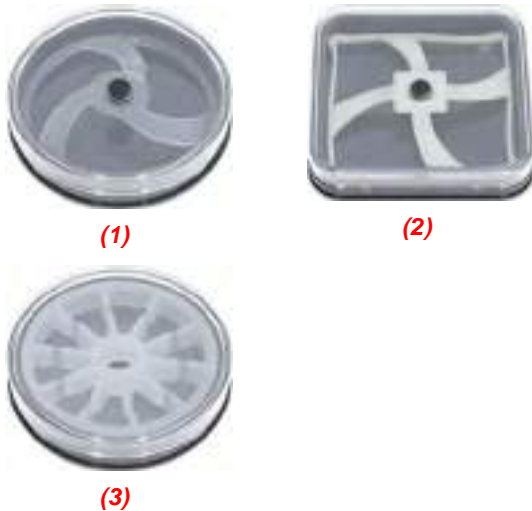

MSA	Shape	Internal size	Kg
17.583-35	(1) Round	Ø 35 mm	0.007
17.583-45	(1) Round	Ø 45 mm	0.010
17.583-60	(1) Round	Ø 60 mm	0.014
17.584-40	(2) Square	40 x 40 mm	0.011
17.585-35	(3) Round	Ø 35 mm	0.010

Plastic case for dial and spare parts packing.

(1+2) : For dials (1 base / 1 lid / 1 flexible support / 1 flexible point).

(3) : For spare parts (1 base / 1 lid / 1 insert).



MSA	Volume	Size	Kg
17.526	50 ml	Ø 42 x 42.50 mm	0.007

Transparent plastic container with lid.



MSA	Size	Kg
17.196	480 x 230 x 230 mm	1.530

Tool box 19".
 - Inside tray with handle
 - Lid "organiser" with 7 cases.
Delivered without tools.



MSA	Size	Kg
17.197	25 x 13 x 41 mm	0.059

Padlock for tool box MSA17.196.
 - Hardened steel shackle
 - Solid brass body.
Delivered with 2 keys.



MSA	Size	Kg
17.198	650 x 325 mm	0.290

Roll-up tool kit in leather imitation with 15 compartments, 1 flap and 1 strap.



(1)



(2)



(3)

MSA	Shape	Compartments	Size	Kg
17.580	(1) Round	6	Ø 89 x 94 mm	0.141
17.581	(2) Rectangular	6	126 x 60 x 94 mm	0.174
17.582	(3) Square	4	80 x 80 x 94 mm	0.144

Stackable tray for spare parts with 1 transparent lid, set of 5 pieces (5 colours).

Material : ABS plastic (Acrylonitrile Butadiene Styrene).

Internal height 15 mm ; divisions height 4 mm.

Tray interior size :

(1) Ø 81 mm

(2) 120 x 53 mm

(3) 74 x 74 mm

Spare parts :

MSA	Item	Kg
17.580-A	(4) Transparent lid for MSA17.580	0.007
17.581-A	(5) Transparent lid for MSA17.581	0.008
17.582-A	(6) Transparent lid for MSA17.582	0.007



(4)



(5)



(6)

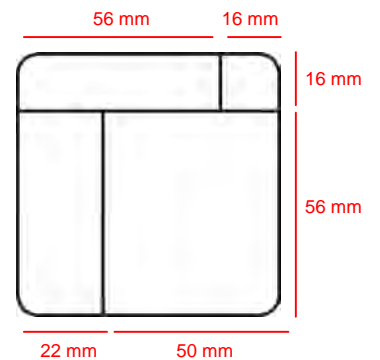
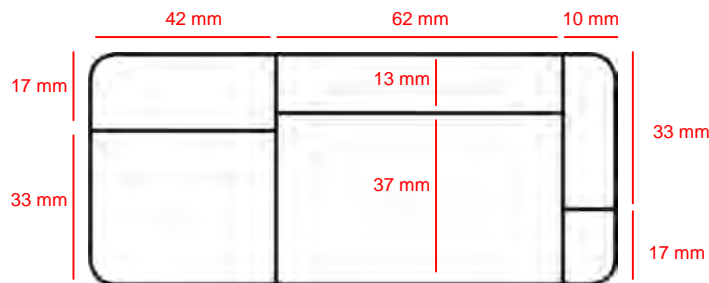
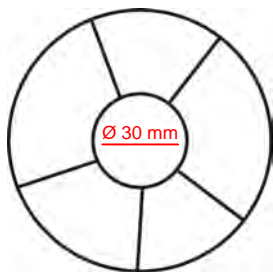

Glassine paper bags, ideal for very delicate items.

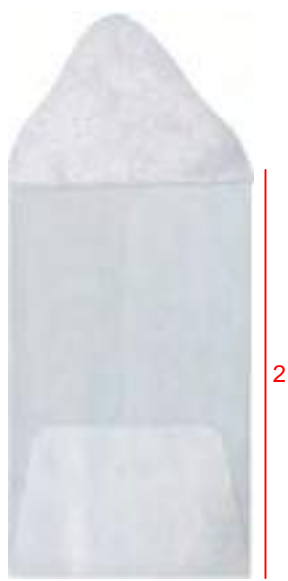

1000 pieces

1

MSA	Size 1 x 2	Quantity	Kg
17.710-3030	30 x 30 mm	1000	0.210
17.710-3636	36 x 36 mm	1000	0.267
17.710-4040	40 x 40 mm	1000	0.300
17.710-4545	45 x 45 mm	1000	0.355
17.710-5263	52 x 63 mm	1000	0.578
17.710-6010	60 x 100 mm	1000	0.650

Glassine paper bag 50 g/m2 without printing.
Grooved execution cut and glued.

Plastic bags, seamless edges, ideal for small components.



100 pieces

1

MSA	Size 1 x 2	Quantity	Kg
17.703-40X65	40 x 65 mm	100	-
17.703-45X65	45 x 65 mm	100	-
17.703-45X250	45 x 250 mm	100	-
17.703-50X80	50 x 80 mm	100	0.035
17.703-50X150	50 x 150 mm	100	-
17.703-50X250	50 x 250 mm	100	-
17.703-55X250	55 x 250 mm	100	-
17.703-60X100	60 x 100 mm	100	-
17.703-80X150	80 x 150 mm	100	0.116
17.703-90X120	90 x 120 mm	100	-
17.703-100X150	100 x 150 mm	100	-
17.703-120X180	120 x 180 mm	100	-

Standard plastic bag, 0.05 mm thickness, without closing zip.

pressure seal bags.



100 pieces

MSA	Size 1 x 2	Quantity	Kg
17.713-050	50 x 70 mm (50 µ)	100	0.065
17.713-080	80 x 100 mm (100 µ)	100	0.225
17.713-100	100 x 150 mm (100 µ)	100	0.360
17.713-150	150 x 200 mm (100 µ)	100	0.720

Anti-corrosion green pressure seal bag.

Features :

- Material : polyethylene, transparent green
- Thickness 50 or 100 µ
- Corrosion protection, ideal for long term storage and overseas shipping
- Sealing pressure for easy opening and closing of the bag.



100 pieces

MSA	Size 1 x 2	Quantity	Kg
17.714-075	75 x 90 mm (75 µ)	100	0.150
17.714-090	90 x 100 mm (75 µ)	100	0.175
17.714-115	115 x 155 mm (75 µ)	100	0.500
17.714-160	160 x 220 mm (75 µ)	100	0.580
17.714-250	250 x 300 mm (75 µ)	100	1.250

Antistatic/ESD pink pressure seal bag.

Features :

- Material : polyethylene, transparent pink
- Thickness 75 µ
- Good electrostatic/ESD protection
- Ideal for storage and shipping of electronic components
- Sealing pressure for easy opening and closing of the bag.



100 pieces

MSA	Size 1 x 2	Quantity	Kg
17.715-075	75 x 90 mm (75 µ)	100	0.205
17.715-090	90 x 110 mm (75 µ)	100	0.132
17.715-115	115 x 155 mm (75 µ)	100	0.330

Black, opaque and UV-resistant pressure seal bag.

Features :

- Material : polyethylene, black opaque
- Thickness 75 µ
- UV-resistant
- Protection of age-sensitive goods
- Prevents yellowing of light-sensitive materials or embrittlement of rubber parts and plastic components due to exposure to light
- Sealing pressure for easy opening and closing of the bag.

Minigrip® plastic bags.



100 or 50 pieces

1

MSA	Size 1 x 2	Quantity	Kg
17.700-040	40 x 60 mm	100	0.046
17.700-050	50 x 75 mm	100	0.070
17.700-075	75 x 90 mm	100	0.104
17.700-090	90 x 110 mm	100	0.158
17.700-100	100 x 125 mm	100	0.185
17.700-115	115 x 155 mm	100	0.256
-	-	-	-
17.700-150	150 x 180 mm	50	0.504
17.700-160	160 x 220 mm	50	0.466
17.700-195	195 x 280 mm	50	0.682
17.700-200	200 x 250 mm	50	0.696
17.700-220	220 x 305 mm	50	0.830

Minigrip® plastic bag. Standard size, 0.05 mm thickness.
Zip to easy open and close the bag. Its ingenious conception prevents from yielding under the weight of the contents.



100 or 50 pieces

1

MSA	Size 1 x 2	Quantity	Kg
17.701-040	40 x 60 mm	100	0.046
17.701-050	50 x 75 mm	100	0.070
17.701-075	75 x 90 mm	100	0.104
17.701-090	90 x 110 mm	100	0.316
17.701-100	100 x 125 mm	100	0.185
17.701-115	115 x 155 mm	100	0.256
17.701-150	150 x 180 mm	100	0.450
-	-	-	-
17.701-160	160 x 220 mm	50	0.466
17.701-200	200 x 250 mm	50	0.696
17.701-220	220 x 305 mm	50	0.700

Minigrip® plastic bag. Standard size, 0.05 mm thickness, with 3 white write-on sections for annotations.
Zip to easy open and close the bag. Its ingenious conception prevents from yielding under the weight of the contents.

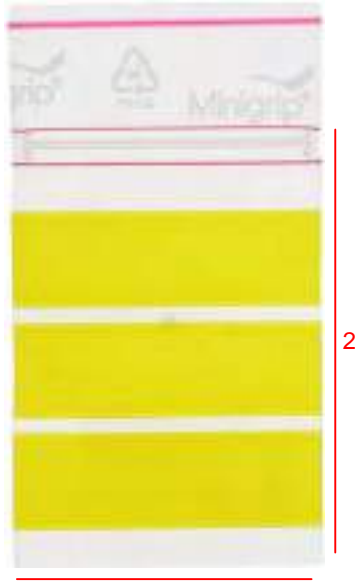

1000 pieces

1

MSA	Size 1 x 2	Quantity	Kg
17.704-040	40 x 60 mm	1000	0.625

Minigrip® plastic bag. Standard size, 0.06 mm thickness, with 3 yellow write-on sections for annotations and reinforced side welds. Zip to easy open and close the bag. Its ingenious conception prevents from yielding under the weight of the contents.



50 pieces

1

MSA	Size 1 x 2	Quantity	Kg
17.702-050	50 x 80 mm	50	0.035
17.702-090	90 x 170 mm	50	0.110

Minigrip® plastic bag, 0.05 mm thickness. Zip to easy open and close the bag. Top hole for hooking the bag on display.

Special plastic bag for chamber machines.



In a 500-piece bag :

MSA	Size 1 x 2	Quantity
17.706-250X500	250 x 500 mm	500
17.706-250X600	250 x 600 mm	500
17.706-260X450	260 x 450 mm	500
17.706-300X500	300 x 500 mm	500
17.706-300X600	300 x 600 mm	500
17.706-300X700	300 x 700 mm	500

Special plastic bag (PA/PE 20/70).

In a 1000-piece bag :

MSA	Size 1 x 2	Quantity
17.706-100X250	100 x 250 mm	1000
17.706-100X300	100 x 300 mm	1000
17.706-120X120	120 x 120 mm	1000
17.706-120X160	120 x 160 mm	1000
17.706-120X200	120 x 200 mm	1000
17.706-120X270	120 x 270 mm	1000
17.706-120X300	120 x 300 mm	1000
17.706-120X400	120 x 400 mm	1000
17.706-130X180	130 x 180 mm	1000
17.706-130X200	130 x 200 mm	1000
17.706-130X280	130 x 280 mm	1000
17.706-130X300	130 x 300 mm	1000
17.706-130X380	130 x 380 mm	1000
17.706-140X200	140 x 200 mm	1000
17.706-140X210	140 x 210 mm	1000
17.706-140X270	140 x 270 mm	1000
17.706-150X180	150 x 180 mm	1000
17.706-150X200	150 x 200 mm	1000
17.706-150X230	150 x 230 mm	1000
17.706-150X260	150 x 260 mm	1000
17.706-160X200	160 x 200 mm	1000
17.706-160X300	160 x 300 mm	1000
17.706-165X210	165 x 210 mm	1000
17.706-165X250	165 x 250 mm	1000
17.706-170X250	170 x 250 mm	1000
17.706-170X400	170 x 400 mm	1000

MSA	Size 1 x 2	Quantity
17.706-180X230	180 x 230 mm	1000
17.706-180X240	180 x 240 mm	1000
17.706-180X250	180 x 250 mm	1000
17.706-180X260	180 x 260 mm	1000
17.706-180X280	180 x 280 mm	1000
17.706-180X350	180 x 350 mm	1000
17.706-200X220	200 x 220 mm	1000
17.706-200X250	200 x 250 mm	1000
17.706-200X300	200 x 300 mm	1000
17.706-200X350	200 x 350 mm	1000
17.706-200X400	200 x 400 mm	1000
17.706-200X500	200 x 500 mm	1000
17.706-200X600	200 x 600 mm	1000
17.706-220X300	220 x 300 mm	1000
17.706-225X350	225 x 350 mm	1000
17.706-230X380	230 x 380 mm	1000
17.706-250X280	250 x 280 mm	1000
17.706-250X300	250 x 300 mm	1000
17.706-250X350	250 x 350 mm	1000
17.706-250X400	250 x 400 mm	1000
17.706-260X350	260 x 350 mm	1000
17.706-270X300	270 x 300 mm	1000
17.706-300X300	300 x 300 mm	1000
17.706-300X350	300 x 350 mm	1000
17.706-300X400	300 x 400 mm	1000
17.706-320X320	320 x 320 mm	1000

Special plastic bag (PA/PE 20/70).

Anti-dust dome.



MSA	Ø base	Dome size	Kg
17.600	90 mm	Ø 70 x 120 mm	0.133

Anti-dust dome with hook for watches and jewellery, with plastic base and transparent plastic dome.

Protection covers.



(1)

MSA		Size	Kg
17.015	(1)	310 x 120 x 50 mm	0.685
17.016		310 x 230 x 50 mm	0.870

Plexiglas anti-dust protection cover.

Dustproof cover.



PERF	Well	Kg
106	100 mm	0.070

Protection kit composed of one dustproof cover and one base with 6 divisions for small parts.

Benzine cups and containers.



MSA	Volume	Size	Kg
17.305	150 ml	Ø 98 x 81 mm	0.820

Stainless steel benzine container with safety lid for cleaning, removing grease and rust with with flammable or toxic liquids. In case of inflammation of the fluid, the copper fuse melts, the lid closes automatically and smothers the fire. The closed lid remains under pressure, prevents the spread of toxic fumes and protects the health of the staff. A special anchoring allows fixing the benzine container at the workplace, which prevents liquids from spilling.

Delivered with a cooper fuse and a gasket for the lid.

Delivered without basket.

Base size : 100 x 140 x 5 mm.

Spare part :

MSA	Item
17.305-F	Copper fuse

Accessory :

MSA	Item	Kg
17.305-P	Stainless steel basket, Ø 85 x 30 mm	0.075



MSA	Volume	Ø base	Size	Kg
17.306	40 ml	228.25	Ø 75 x 46 mm	0.293

Stainless steel benzine container with safety lid for cleaning, removing grease and rust with with flammable or toxic liquids.

In case of inflammation of the fluid, the copper fuse melts, the lid closes automatically and smothers the fire. The closed lid remains under pressure, prevents the spread of toxic fumes and protects the health of the staff.

Delivered with a cooper fuse and an orange gasket for the lid.

Spare parts :

MSA	Item
17.305-F	Copper fuse
17.306-J	Orange gasket



MSA	Volume	Size	Kg
17.317	50 ml	Ø 46 x 94 ml	0.115

Glass bottle for Epilames with pierced steel basket.

For use with Episurf-Neo, EpiDrop and Moebius Fixodrop.

Inner size of the basket : Ø 16 x height 8 mm.



MSA		Volume	Size	Kg	Ø plateau
17.314	(1)	180 ml	55 x 55 x 110 mm	0.067	
17.319	(2)	120 ml	55 x 55 x 80 mm	0.076	18.45 (10) 16.30

Antistatic solvent dispenser.
Ideal for a wide range of applications in the watchmaking, electronics and medical industries.

The main advantages are :

- Dispenses clean
- Prevents evaporation and contamination
- Suitable for most liquids like solvents, degreasers, oils
- Easy use
- Reduces waste
- Prevents fumes, accident and spillage
- ESD safe (electrostatic discharge)
- Surface resistivity 107 to 109 Ohm
- No charge generation, no fire or explosion ignition risk
- The "anti-splash" function prevents splashing, liquid back-flow and eye protection
- Fluid pumped into the dish does not drip back into the bottle, keeping stored liquids uncontaminated.



MSA	Ø	Kg
17.300	60 mm	0.230
17.301	80 mm	0.400
17.302	100 mm	0.540
17.303	150 mm	1.030

Glass benzene cup for daily use of benzene, alcohol or other solutions.
The lid with button prevents the entry of dust and the premature evaporation of solutions.



MSA	Size	Kg
17.318	Ø 36 x 36 mm	0.029

Glass benzene cup for benzene, alcohol or any other solutions.
The lid with button prevents the entry of dust and the premature evaporation of solutions.

Inner size : Ø 32 x height 30 mm.
Total height with button : 54 mm.



MSA	Ø	Kg
17.310	60 mm	0.205
17.311	80 mm	0.325
17.312	100 mm	0.505
17.313	150 mm	1.000

Glass benzene cup for daily use of benzene, alcohol or other solutions.
The lid without button prevents the entry of dust and the premature evaporation of solutions.



MSA	External size	Kg
17.320-060	Ø 60 x 15 mm	0.055
17.320-080	Ø 80 x 15 mm	0.085
17.320-100	Ø 100 x 20 mm	0.145
17.320-150	Ø 150 x 25 mm	0.220

Glass dishes offer watchmakers an essential tool for the meticulous cleaning of watch parts.

These boxes ensure a sterile environment, protecting the parts from any contact with external dirt.

Their crystal-clear transparency allows complete visual control of the cleaning process, while the tight-fitting lids guarantee a reliable seal.



MSA	Volume	Kg
17.335	100 ml	0.017

Plastic burette with long tip nose.



MSA	Volume	Kg
17.336	50 ml	0.017

Plastic burette with dropper cap.

A burette enables small quantities of lubricant to be applied in the proper place.



(1)



(2)

MSA	Volume	Size	Kg
17.307 (1)	2 ml	Ø 14 x 26 mm	-
17.308 (2)	2 ml	Ø 14 x 26 mm	-

Glass storage bottle with yellow cap.

MSA17.307 : in amber glass.

MSA17.308 : in transparent glass.

Storage cabinet.



MSA	Kg
17.850	29.300

Storage cabinet with controlled humidity for components.
 - Metallic cabinet with 2 doors lockable by key and 3 separation trays
 - Humidity level automatically adjustable from 25 to 55% and controllable by indicator on the front panel.

Features :
External size : 80.0 x 83.5 x 45.5 cm
Internal size : 76.4 x 74.0 x 40.0 cm
Hygrometer : Analogic
Consumption : 12 Watts
Voltage : 220 V

18



HANDLES

HANDLES

File handles.



MSA	Colour	Length	Ø ring	Ø handle	Ø hole	Kg
18.050	Blue	90 mm	16 mm	23 mm	4.00 mm	0.025
18.051	Red	100 mm	18 mm	25 mm	5.50 mm	0.033
18.052	Black	110 mm	19 mm	28 mm	7.00 mm	0.043
18.053	Green	120 mm	21 mm	31 mm	9.00 mm	0.055

File round shape plastic handle.



MSA	Length	Ø ring	Ø handle	Ø hole	Kg
18.100	80 mm	14 mm	21 mm	3 mm	0.017
18.101	90 mm	16 mm	22 mm	4 mm	0.022
18.102	100 mm	18 mm	25 mm	4 mm	0.027
18.103	110 mm	18 mm	26 mm	5 mm	0.036

File round shape wooden handle.



MSA	Length	Ø handle	Ø hole	Kg
18.110	110 mm	10 mm	2.00 mm	0.007
18.111	110 mm	12 mm	2.00 mm	0.009
18.112	110 mm	14 mm	2.00 mm	0.013
18.113	110 mm	16 mm	2.50 mm	0.015
18.114	110 mm	18 mm	3.00 mm	0.021
18.115	110 mm	20 mm	3.50 mm	0.027

File cylindrical shape wooden handle.

vallorbe



UAL	□	○	◐	◑	◒	◓	L mm	Kg
110-BLEU	-	4"	-	4"	-	-	94 mm	0.039
210-BLEU	4-5"	5-6"	-	5"	-	-	94 mm	0.041
310-BLEU	4-6"	-	4"	6"	4"	4"	94 mm	0.042
410-BLEU	8"	8"	6"	8"	6"	6"	105 mm	0.045
510-BLEU	8-10"	10-12"	8"	10"	8"	8"	105 mm	0.052
610-BLEU	10-12"	-	10"	10-12"	10"	10"	121 mm	0.082
710-BLEU	-	-	12"	-	12"	12"	130 mm	0.094

Antislip plastic handle with hardened threaded insert.

vallorbe



UAL	Ø	L mm	Kg
160	2-3 mm	95 mm	0.028
260	3-4 mm	95 mm	0.028

Precision handle for needle files.

vallorbe



UAL	L mm	Kg	
170	2-3 mm	86 mm	0.015

Handle for needle files.

valorbe



UAL	□	○	◐	◑	◒	L mm	Kg
200	-	-	4"	-	4"	80 mm	0.020
400	6"	6"	5"	6"	5"	100 mm	0.025
500	8"	8"	6"	8"	6"	115 mm	0.040
600	10"	10"	8-10"	10"	8-10"	125 mm	0.055

Wooden files handle.

Handles for ceramic fibre files.

valorbe



UALF		For files	Kg
105	(1)	A = 0.5 mm	0.010
109		A = 0.9 mm	0.010
202	(2)	A = 2.34 mm	0.010
203	(3)	A = 3.0 mm	0.013
301	(4)	A = 1 mm	0.010
302		A = 2 mm	0.010
304		A = 4 mm	0.011

Handle for ceramic fibre files.

Graver handles.



MSA	Length	Ø ring	Ø handle	Ø hole	Kg
18.120	65 mm	12 mm	27 mm	2.50 mm	0.014

Graver wooden handle.



MSA	Length	Ø ring	Ø handle	Ø hole	Kg
18.130	40 mm	11 mm	34 mm	2.00 mm	0.012

Graver wooden handle.



MSA	Length	Ø ring	Ø handle	Ø hole	Kg
18.131	40 mm	10 mm	34 mm	2.50 mm	0.014
18.132	50 mm	12 mm	34 mm	2.50 mm	0.018

Graver wooden handle.



MSA	Length	Ø ring	Ø handle	Ø hole	Kg
18.140	40 mm	10 mm	32 mm	2.50 mm	0.013

Graver wooden handle.

HANDLES



MSA	Length	Ø ring	Ø handle	Ø hole	Kg
18.150	40 mm	10 mm	34 mm	2.50 mm	0.015

Graver wooden handle.



MSA	Length	Ø ring	Ø handle	Kg
18.200	70 mm	12 mm	34 mm	0.033

Graver wooden handle with 2 tightening chucks.

- Ø 0...1.60 mm
- Ø 1.60...3.00 mm.



MSA	Head	Kg
18.130-S	50 mm	0.014

Wooden handle for beading tools with 1 brass die Ø 2.60 mm to quickly fit the beading tool.

Engraver handles.



MSA	Length	Ø ring	Ø handle	Kg
18.203	75 mm	12 mm	34 mm	0.025

Engraver wooden handle with 2 tightening chucks.

- Ø 0...1.60 mm
- Ø 1.60...3.00 mm.



MSA	Length	Ø ring	Ø handle	Kg
18.204	75 mm	12 mm	30 mm	0.030

Engraver wooden handle with 1 tightening chuck.

- Ø 1.80...3.00 mm
- Square headed chuck to tighten a tool using pliers.

Hammer handles.



MSA	Length	Kg
04.102	240 mm	0.060
04.103	260 mm	0.060

Wooden handle for chase hammers, with straight oval shape.



MSA	Length	Head	Kg
04.104	235 mm	11 x 11 mm	0.035
04.105	245 mm	11 x 13 mm	0.038
04.106	255 mm	11 x 14 mm	0.042

Wooden handle for watchmaker hammers.

19



TESTING	19 - 2
WATCH WINDERS	19 - 9
WATERPROOF TESTERS	19 - 14
CLEANING	19 - 18
PACKAGING	19 - 32
VACUUM / COMPRESSED AIR	19 - 34
ADHESIVES	19 - 39
POLYMERISATION / UV	19 - 42
MAGNETISM	19 - 43



MSA	Voltage	Size	Kg
19.115	Dual 115 - 230 V	155 x 172 x 55 mm	0.900

Multifunctional portable touchscreen tester HOROTEC® FLASHTEST specifically designed for the control of watches and quartz mechanisms. This precision device is easy to handle and is intended to test analogue quartz watches and movements with both closed and open watchcases.

Measurements and functions :

- Measuring tension of unloaded batteries from 0 to 19.999 V
- Measuring tension of batteries under load from 0 to 19.999 V
- Measuring the movement supply voltage (1.5 V or 3.0 V)
- Measuring the coil resistance
- Unjamming the wheel trains
- Measuring the rate stability or the gain/loss of a watch or a movement
- Checking the correct functioning of the circuit : electrical impulse and consumption of the electric circuit
- Measuring the consumption of a watch during its operation.

Display : colour touchscreen 48 x 36 mm.

Delivered with 2 precision probes , 1 adaptor 12 V (input 115 - 230 V AC / output 12 V DC), 1 9 V battery and 1 operating manual.

Spare part :

MSA	Item	Kg
19.115-A	Pair of probes	0.015

Accessory :

MSA	Item	Kg
19.108-E	Calibration device	0.043



MSA	Size	Kg
19.106	60 x 105 x 28 mm	0.225

HOROTEC® PULSE is an electronic device for testing the electronic parts (coil/circuit) of analogic quartz watch movements. Delivered with 1 battery 9 V and multi-lingual operating instructions.



MSA	Size	Kg
19.107	60 x 105 x 28 mm	0.235

HOROTEC® TURBO is an electronic device for testing the mechanical parts (wheel train) of analogic quartz watch movements.
Do not use it for testing mechanical watches.
Delivered with 1 battery 9 V and multi-lingual operating instructions.

ECOLINE



MSA	Size	Kg
19.000	100 x 70 x 40 mm	0.115

Universal battery tester suitable for any type of batteries from 1.5 to 22.5 V : 1.5 V type AA, AAA button, lithium 3 V, Photo 6 V, 9 V, etc.).
Delivered with operating instructions.

ECOLINE



MSA	Size	Kg
19.105	85 x 150 x 55 mm	0.250

Battery, coil and electronic function tester for analogical quartz watches.
Delivered with 1 battery 9 V and operating instructions.



MSA	Apparatus	Voltage	Casing size	Kg
19.214	MTG-1100	90 - 240 V	240 x 190 x 180 mm	1.100

MTG-1100 simple tester for mechanical watches, equipped with a microphone and a 4.3" high-resolution digital coloured LCD screen. There are three keys to operate. The diagram display is horizontal. It also has all the basic test functions. Compact and easy-to-use model.

- Displays daily rate in seconds per day (+/- 300 s/d), accuracy (+/- 1 s/d)
- Amplitude : 90 – 350°, allowable tolerance (+/- 3°)
- Beat error : 0 - 4.0 ms, allowable tolerance (+/- 0.1 ms).



MSA	Apparatus	Voltage	Casing size	Kg
19.213	MTG-2200	90 - 240 V	360 x 165 x 190 mm	2.000

MTG-2200 economical tester for mechanical watches, equipped with a standard microphone and a 5" high-resolution digital coloured LCD screen. There are three keys to operate. The tester has all the basic test functions. It has three display models of diagram of beat noises. Compact and easy-to-use model.



MSA	Apparatus	Voltage	Casing size	Kg
19.172	(1) MTG-4000A	100 - 240 V	260 x 170 x 120 mm	1.900
19.174	MTG-4000T	100 - 240 V	260 x 170 x 120 mm	1.900

MTG-4000 testing device for mechanical watches. Complete, multifunctional model for professional use.

Functions :

- Measurement of beat rate (sec/day), mechanical watch beat error m/s and watch beat diagram
- Acoustic watch beat simulation (can be switched off)
- Amplitude measurement over a range of 90° to 350°, lift angle selection from 30° to 60° with 0.1° resolution
- 6 programmed positions with test report
- "Pause" and "Shift" functions to stop the current measurement and view previous stored beats
- TYAPS signal processing unit which automatically controls the signal level and filters peripheral noise
- Highly stable TCXO quartz oscillator for time base : +/- 0.1 sec/day
- Results are displayed on a 7" (153 x 86 mm) colour LCD screen.

MSA19.172 (4000A) : 1 microphone

MSA19.174 (4000T) : 3 microphones



(1)



(2)

MSA		Apparatus	Voltage
19.209-A	(1)	MTG-9900A	100 - 240 V
19.209	(2)	MTG-9900	100 - 240 V

MTG-9900A and MTG-9900 testers for mechanical watches with touch screen.

Complete multifunction version for professional use, ideal for efficient and fast tests during production, after sales service and watch-test lab.

MSA19.209-A: 1 MTG-9900A device, 1 AUTOMIC-3 automatic microphone and 1 thermo-sensitive printer.

MSA19.209: 1 MTG-9900 device and 1 standard microphone.

Functions :

- Measuring of beat rate (+/- 300 sec/day ; precision +/- 1 sec/day), model MSA19.209-A only
- Amplitude measurement range from 90° to 350°, lift angle selection from 20° to 70°, model MSA19.209-A only
- Number of beats : 12000, 14400, 18000, 19800, 21600, 25200, 28800 and 36000 beats/hour. Can be selected automatically or manually
- 6 control positions.



MSA		Kg
19.177		1.030

Thermo printer THERMOPRINT for MTG testers.

Spare part :

MSA	Item	Kg
19.177-A	Thermo paper, Ø 30 x 57 mm	0.032



MSA	Voltage	Size	Kg
19.158	230 V	260 x 150 x 130 mm	1.500
19.158-110	120 V	260 x 150 x 130 mm	1.500

The NEW TECH HANDY II measures the rate accuracy and power consumption of quartz watches and quartz watch movements and facilitates the testing of other components such as coil resistance, insulation and battery voltage.

Spare parts :

MSA	Item
19.158-A	Measuring cable with 2 probes, pair
19.160-B	Mobile probe, pair



MSA	Voltage	Size	Kg
19.152	230 V	290 x 170 x 180 mm	2.800
19.152-110	120 V	290 x 170 x 180 mm	2.800

The ANALYZER Q1 provides excellent measurement and testing facilities for the specialist testing and measurement of quartz watches. The ANALYZER Q1 is a testing device for efficient use in a repair service as well as for analyses during watch production, in watchmaking laboratories and in sales situations.



MSA	Voltage	Size	Kg
19.202	100 - 240 V	197 x 164 x 130 mm	1.700

The WATCH EXPERT G4 is the ideal, cost-effective measuring device for testing and measuring the rate accuracy, amplitude and beat error of mechanical watches during watch production and servicing.

Spare part :

MSA	Item	Kg
19.157-M	Microphone	1.300



MSA	Version	Voltage	Size	Kg
19.221	(1) Standard version	230 V	130 x 110 x 110 mm	0.800
19.222	(1) PRO version with software	230 V	130 x 110 x 110 mm	0.800
19.226	AIR (Bluetooth) version with software	230 V	130 x 110 x 110 mm	0.610

CHRONOMASTER control instrument for mechanical watches easily connectable to a PC or tablet. The compact microphone has integrated measurement electronics. The measurement results are displayed on the PC or tablet screen.



MSA	Microphone	Voltage	Casing size	Kg
19.130	(1) With	100 - 240 V / 50-60 Hz	225 x 85 x 191 mm	3.100
19.131	Without	100 - 240 V / 50-60 Hz	225 x 85 x 191 mm	2.900

The CHRONOSCOPE S1 (G2) is a highly professionally measuring device for the efficient testing and measurement of mechanical watches in a repair service, quality control and the industrial sector of the clock and watchmaking industry.

Spare part :

MSA	Item
19.150-B	Microphone

Accessories :

MSA	Item
19.155-B	Automatic microphone Micromat S, 220 V
19.155-B110	Automatic microphone Micromat S, 110 V



MSA	Microphone	Voltage	Casing size	Kg
19.188	With	100 - 240 V	266 x 213 x 43 mm	2.100

The CHRONOSCOPE X1 (G3) is the high-end watch testing device for mechanical watches and has at its disposal the latest technologies for testing and measuring mechanical watch movements during production, in a repair service or laboratory.

Delivered with 1 automatic microphone Micromat C, 1 network adapter, 1 protection cover and 1 operating instructions.



MSA	Voltage	Size	Kg
19.155-C	230 V	115 x 125 x 215 mm	1.700

The modular, space-saving MICROMAT C system is a highly professional measuring station for the testing and regulation of production runs in the laboratory, during watch production and in a repair service. The measurement results of the mechanical watch test are displayed on a PC with the MICROMAT C system. You can connect up to a maximum of 10 independent test channels (microphones) to the same PC.



MSA	Voltage	Size
19.203	100 - 240 V	112.5 x 200 x 125 mm

Thermo printer JB01-SLK-TE25-Sfor WITSCHI® testers.



Spare parts :

MSA	Item
19.134-P	(1) Thermo paper, Ø 51 x 60 mm
19.203-A	(2) Bluetooth dongle and plug-in module
19.203-B	(3) Dongle for Witschi® device



MSA	Kg
19.198	0.043

Protection kit of movement on a microphone.
 Composed of a support and an anti-dust cover for a microphone WITSCHI®.
Delivered without microphone or movement.



MSA	Voltage	Size	Kg
19.349	100 - 240 V 50-60 Hz	135 x 289 x 225 mm	8.340

Watch winder for 2 watches.
Noiseless, reliable and modern design with large transparent windows.
Winding function : clockwise and anti-clockwise, automatic (bi-directional).

4 timer modes (TPD=Turns Per Day) :

A : 650 TPD, 13 cycles, 50 turns per cycle, then rest.

Each cycle takes 110 minutes.

B : 900 TPD, 18 cycles, 50 turns per cycle, then rest.

Each cycle takes 80 minutes.

C : 1200 TPD, 24 cycles, 50 turns per cycle, then rest.

Each cycle takes 60 minutes.

D : 1500 TPD, 30 cycles, 50 turns per cycle, then rest.

Each cycle takes 48 minutes.

Operates via a 100 - 240 V network adapter, delivered with the device.



MSA	Voltage	Size	Kg
19.363	100 - 240 V 50-60 Hz	141 x 192 x 243 mm	1.175

Watch winder for 2 watches.
Noiseless, reliable and modern design with large transparent windows.
Winding function : clockwise and anti-clockwise, automatic (bi-directional).

4 timer modes :

A : 650 TPD, rotates 7 min. (50 rotations), rest 104 min., then new cycle.

B : 900 TPD, rotates 7 min. (50 rotations), rest 73 min., then new cycle.

C : 1200 TPD, rotates 7 min. (50 rotations), rest 53 min., then new cycle.

D : 1500 TPD, rotates 7 min. (50 rotations), rest 41 min., then new cycle cycle.

Operates via a 100 - 240 V network adapter, delivered with the device.



MSA	Voltage	Size	Kg
19.360	100 - 240 V 50-60 Hz	151 x 151 x 171 mm	0.450

Watch winder for 1 watch.
Noiseless, reliable and modern design with a large transparent window and lighting spread by LED.
Winding function : clockwise and anti-clockwise, automatic (bi-directional).

4 timer modes (TPD=Turns Per Day) :

A : 650 TPD, rotates 5 min., rest 79 min., then new cycle.

B : 900 TPD, rotates 5 min., rest 56 min., then new cycle.

C : 1200 TPD, rotates 5 min., rest 41 min., then new cycle.

D : 1500 TPD, rotates 5 min., rest 32 min., then new cycle.

3 buttons on the back of the device :

- TPD (selection of the number of turns per day)

- LED (device lighting)

- Switching on and selecting the direction of rotation.

Operates via a 100 - 240 V network adapter, delivered with the device.



MSA	Apparatus	Voltage	Kg
19.205	REGLOMAT Final-Test	220 V	2.780
19.205-110	REGLOMAT Final-Test	110 V	2.780
19.305	(1) CYCLOTEST Automatic-Test	220 V	2.905
19.305-110	CYCLOTEST Automatic-Test	110 V	2.905

Watch winder for 18 watches with :
 - 3 arms with clips for 9 watches without bracelets
 - 3 arms with foam for 9 watches with bracelets.

The REGLOMAT apparatus (1 rpm) tests the following : slow winding, power on wrist, shock tests, calendar and detects hidden defects.

The CYCLOTEST apparatus (4 rpm) tests the following : accelerated winding, wheel (and pinion) speed, and power reserve.



MSA	Apparatus	Voltage	Kg
19.206	(1) REGLOMAT Final-Test	220 V	2.780
19.206-110	REGLOMAT Final-Test	110 V	2.780
19.306	CYCLOTEST Automatic-Test	220 V	2.905
19.306-110	CYCLOTEST Automatic-Test	110 V	2.905

Watch Winder for 20 watches with :
 - 2 arms with clips for 6 watches without bracelets
 - 2 arms with foams for 6 watches with bracelets
 - 2 arms with springs for 8 watches with bracelets.

The REGLOMAT apparatus (1 rpm) tests the following : slow winding, power on wrist, shock tests, calendar and detects hidden defects.

The CYCLOTEST apparatus (4 rpm) tests the following : accelerated winding, winding speed and power reserve.

Spare parts for MSA19.205, MSA19.206, MSA19.305 and MSA19.306 :

MSA	Item	Kg
19.201-A	Arm with spring for 1 watch with bracelet	0.015
19.201-B	Arm with clips for 2 watches without bracelets	0.052
19.205-A	Arm with clips for 3 watches without bracelets	0.056
19.205-B	Arm with foams for 3 watches with bracelets	0.064
19.205-C	Arm with springs for 4 watches with bracelet	0.100
19.205-E	Foam without arm	0.001



(1)



(2)



(3)



(4)



(5)



(6)



(1)

MSA	Version	Voltage	Size	Kg
19.450	(1) Without arms	100 - 240 V	465 x 325 x 520 mm	10.500
19.451	With 6 arms MSA19.450-B	100 - 240 V	635 x 325 x 585 mm	11.000

CYCLOMOTION watch winder for automatic watch winding and for work testing.

Noiseless motor equipped with a clutch system suitable for heavy and big watches. It is controlled by soft touch keys on the front plate.

Maximum capacity : 24 watches (6 arms for 4 wrist watches each).
Rotation speeds : 1 or 4 rpm.

Spare parts :

MSA	Item
19.450-A	(1) Arm for 2 watches with bracelet
19.450-B	(2) Arm for 4 watches with bracelet
19.450-C	(4) Arm for 4 watches with bracelet
19.450-D	(5) Arm for 4 watches without bracelet
19.450-E	(3) Arm for 2 watches with bracelet
19.450-F	(6) Wall mounting kit
19.453	(7) Box for 4 watches without bracelet



(1)



(2)



(3)



(4)



(5)



(6)



(7)

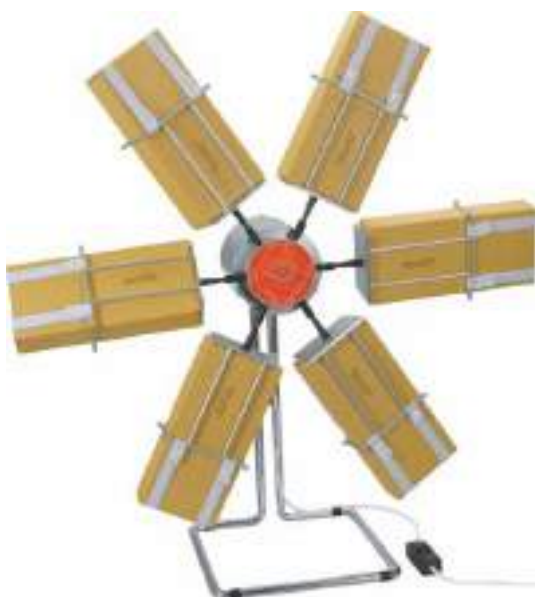

MSA	Voltage	Kg
19.320	220 V	8.000

Watch winder for 60 watches with :

- 6 arms with 6 boxes for 10 watches without bracelets or 10 movements.
The CYCLOTTEST tests the following : winding acceleration, winding speed and power reserve.

Rotation speed : 4 rpm.

Spare parts :

MSA	Item
19.320-B	Button for closing the rubber MSA19.320-E
19.320-C	Box for 10 watches or movements
19.320-E	Rubber for holding the box MSA19.320-C
19.320-EB	Rubber with 2 buttons for holding the box MSA19.320-C



----- (a)

(a) Delivered without support for watches with bracelet

MSA	Voltage	Size	Kg
19.372	230 V	55 x 40 x 45 cm	13.000

CLINAX, small capacity 45° pendulum rotary movement machine. For winding automatic watches in small series.

Capacity : up to 60 watch heads (or movements) and/or 16 watches with bracelets (depending on the type of assembly).

Accessory :

MSA	Item
19.372-A	(a) Support for watches with bracelet



MSA	Voltage	Size	Kg
19.371	230 V	110 x 48 x 49 cm	63.000

STANDARD III, medium capacity 45° pendulum rotary movement machine. It is used for industrial winding of automatic watches, as well as for shock tests on watch heads.

Capacity : up to 250 watch heads (or movements).



MSA	Voltage	Size	Kg
19.376	230 V	150 x 53 x 50 cm	98.000

SUPER E, high capacity 45° pendulum rotary movement machine. It is used for industrial winding of automatic watches, as well as for shock tests on watch heads.

Capacity : up to 500 watch heads (or movements).



MSA	Voltage	Size	Kg
19.370	230 V	56 x 60 x 33 cm	37.000
19.370-110	110 V	56 x 60 x 33 cm	37.000

DUOTEST 48, medium capacity rotary combination machine. This machine is specially designed for small quantities and is very suitable for after-sales service and shops.

It is used for winding automatic watches and for rate tests. Capacity : up to 48 watch heads (or movements) or 48 watches with bracelets (depending on the type of assembly).



MSA	Voltage	Size	Kg
19.399	230 V / 50 Hz	110 x 110 x 50 cm	128.000
19.399-110	(a) 110 V / 50 Hz	110 x 110 x 50 cm	128.000

DUOTEST 4, high capacity rotary combination machine. It is used for winding automatic watches and for rate tests. Capacity : up to 300 watch heads (or movements) or 120 watches with bracelets (depending on the type of assembly).

(a) Requires a 110 V transformer



MSA	Size	Kg
19.373-F	312 x 128 x 23 mm	0.100

Blue plastic container.



MSA	Size	Kg
19.374-F	312 x 128 x 18 mm	0.100

Transparent cover for plastic containers.



MSA	Shape	Cases	Cases Size	Notch	Kg
19.373-A	Rectangular	8	70 x 50 mm	Without	0.010
19.373-B	(1) Television	5	66 x 53 mm	2	0.100
19.373-C	(2) Television	10	51 x 50.5 mm	1	0.100
19.373-E	(3) TV + Bracelet	5+1	51 x 50.5 mm	1	0.100
19.374-A	(4) Round	10	Ø 50 mm	1	0.100
19.374-B	Round	10	Ø 40 mm	1	0.100
19.374-C	Round	10	Ø 45 mm	1	0.100
19.374-D	Round	10	Ø 48 mm	1	0.100
19.374-E	Watch + Bracelet	2	-	Without	0.100

Blue plastic container with cut foams in different shapes.
To be used with apparatus MSA19.370, 19.371, 19.372, 19.376 and 19.399.
For watches with or without bracelets and movements.
Delivered without cover (see MSA19.374-F).



MSA	Size	Kg
19.373-D	330 x 165 x 40 mm	0.100

Blue plastic container with cut foam and transparent cover.
Cases shape : television 62 x 55 mm with 2 notches.

To be used with apparatus MSA19.370, 19.371, 19.372, 19.376 and 19.399 (according to tray holder).



MSA	Size
19.373	240 x 110 x 20 mm

Green plastic container (10 compartments) and transparent lid with protection foams.

To be used with apparatus MSA19.370, 19.371, 19.372, 19.376 and 19.399 (according to tray holder).

WATERPROOF TESTERS



MSA	Voltage	Size	Kg
19.449	100 - 240 V	157 x 190 x 240 mm	2.000

Waterproof tester by vacuum VACUPRO.
Bubbles are formed on the watch to indicate the exact location of the leak.
Delivered with 1 network adapter 100-240 V, 1 battery 9 V and 5 most common worldwide adapters.



MSA	Size	Kg
19.448	280 x 100 x 200 mm	6.400

Waterproof tester DIVER 125.
-Robust anodized aluminium construction
- Chamber diameter : Ø 63 mm (2.5")
- Chamber depth : 50 mm (2").

... 125 bar



MSA	Version	Size	Kg
19.406	Standard	200 x 170 x 270 mm	3.500
19.424	(1) Plus	200 x 170 x 270 mm	3.500

CALYPSO waterproof tester used with water.
Cylinder Ø 80 mm for 2 watches.

*MSA19.406 (Standard version) :
The pressure is generated by a manual pump.*

*MSA19.424 (Plus version) :
Suitable for both air admission by a manual pump or compressor (not delivered). On compressor mode, the pressure adjustment inside the cylinder is made with an air-gate located in front of the tester.*

... 10 bar



MSA	Version	Size	Kg
19.425	Minus	200 x 170 x 270 mm	3.500

CALYPSO waterproof tester used with water.
Cylinder Ø 80 mm for 2 watches.

This version is used with a compressor (not delivered). The pressure adjustment inside the cylinder is made with an air-gate located in front of the tester.

... 10 bar



0 ... 40 bar

MSA	Size	Kg
19.416	250 x 270 x 250 mm	7.000

NATATOR 40 waterproof tester, suitable for after sales service single test. Doesn't require any electric plug in. Stainless steel tank Ø 65 x 650 mm. After the water filling (maximum 0.2 L), the lid with window is locked. The control is made using the lateral handle, which will be screwed until the desired pressure indicated on the manometer. *No compressor required.*



0 ... 125 bar

MSA	Size	Kg
19.429	310 x 330 x 300 mm	12.000

NATATOR 125 waterproof tester, Suitable for after sales service single test. Doesn't require any electric plug in. Stainless steel tank Ø 80 x 65 mm. After the water filling (maximum 0.33 L), the lid is locked. The control is made using the lateral handle, which will be screwed until the desired pressure indicated on the manometer. *No compressor required.*



-0.7 ... 10 bar

MSA	Voltage	Size	Kg
19.407	DUAL 115 - 230 V	320 x 250 x 280 mm	7.500

POSEIDON LT100 high-tech waterproof tester with the following characteristics :

- Universal use with all types of watches with or without bracelets
- The test starts automatically under vacuum and pressure
- Automatic determination of stabilisation and measuring time for reliable results
- With colour display in 8 languages. Indication of the results in numerical way as well as in analogical colour diagram
- 12 available programs including 7 individually programmable from -0.7 to 10 bar
- RS 232 interface for printout of certificate.
- Printout the results on a thermo printer.

Compressor delivered separately (see page 19-XX).

WATERPROOF TESTERS

Greiner vitrograt



... 0.7 bar

MSA	Kg
19.403	3.200

LEAK-CHECKER PRIME waterproof tester for testing leaks up 0.7 bar vacuum.

- No additional compressor needed thanks to integrated pump
- Suitable for any type of watches, included very small ceramic timepieces
- Programmable vacuum in steps of 0.1 bar
- Results displayed on a 5" colour touchscreen TFT (800 x 480 pixels)
- Printout the results on a thermo printer.



(1)

MSA	Voltage	Size	Kg
19.129	115 - 230 V	260 x 170 x 110 mm	1.000

Thermo printer MARTEL 7830 suitable for all GREINER® waterproof testers.

Spare part :

MSA	Item	Kg
19.167-B	(1) Thermo paper, width 57 mm	0.088

Elma



-0.8 bar

MSA	Voltage	Size	Kg
19.402	100 - 240 V	155 x 315 mm	3.500

The LEAK CONTROLLER 2000 waterproof tester produces a pressure difference between the interior and the exterior of the watch, thanks to a built-in vacuum.

The 1µ precision dial comparator records each variation on the watch case and indicates its pressure compensation.

The equipment is almost mechanical, which allows even the tests of cheap watches with deformable glasses (no risk of glass breaking).

Do not require any maintenance.

witschi



-0.1 ... -0.7 bar
0.1 ... 10 bar

MSA	Version	Voltage	Size	Kg
19.217	Standard version	230 V	149 x 305 x 243 mm	5.800
19.216	PRO version with software	230 V	149 x 305 x 243 mm	5.800

The PROOFMASTER tests the water resistance of watches conveniently with a fully automatic closing and test sequence. With its high level of operating convenience, the PROOFMASTER is the ideal tightness testing device for the following areas: watch service centres, watch retailers, watchmaking and watchmaking laboratories.

Compressor with tank releasing pressurised air immediately, allowing waterproof tests to proceed quicker.



MSA	Voltage	Capacity	Size	Kg
19.455	230 V	50 litres/minute	500 x 460 x 600 mm	30.000

Compressor ABSOLUTE AIR with automatic draining, high performance (50 Hz/0.34 kW) and very quiet. 25 litre tank.

16 bar
40 dB

Drier with warm air.

 Greiner vibrograt



MSA	Voltage	Size	Kg
19.750	220 V	190 x 175 x 120 mm	2.810
19.750-110	110 V	190 x 175 x 120 mm	2.810

T8 drier with hot air ventilator for drying watches, jewellery, etc. Power 600 W.

Automatic cleaning machine VIBRATO.



(1)



(2)



(3)



(4)



(5)

MSA	Voltage	Size	Kg
19.705	230 V	480 x 480 x 860 mm	63.000

With its modern and secure design, the fully automatic cleaning machine VIBRATO has been developed for cleaning movement components and any other small watch parts.

- Certified ATEX according to the European directive 2014/34 UE (ATEX 2014) in IIB T4 class
- Ensures maximum safety and allows the use of watchmakers solvents such as rectified benzine
- Its conception with 6 baths (including 1 adjustable ultrasonic tank) + forced air heating system offers unrivalled flexibility and efficiency
- THE ONLY MACHINE enabling watchmakers to use it for washing, drying and epilame coating in 1 cycle.

The several possibilities of movements of the basket and the speed adjustment from 1 up to 1200 rpm guarantee maximum care and efficiency. The drying process is optimized to avoid residues of "dry drops". The machine is equipped with a 7" touch-screen display to manage all operations. Its intuitive and ergonomic presentation allows an easy-to-use interface by the operator. The wash programming, baths management and various configurations are made directly on the touch-screen. Ditto for the management of possible failures, which facilitates the after-sales service on-site by the user himself. A USB2 input allows implementing configurations and wash programs remotely. A rear exit is provided to connect the VIBRATO to an external exhaust or an active carbon filter. The machine is compatible with all existing baskets Ø 80 mm.

Approval institute	TÜV SÜD Schweiz AG
ATEX marking	Ex II 3-G
IEC marking	EX h b IIB T4 Gc
Number of baths	6 (including 1 ultrasound)
Drying station	1 forced air station (adjustable up to 65° C)
Cleaning baskets	Ø 80 mm, up to 5 baskets height 10 mm
Cleaning actions	Rotation, oscillation, vertical agitation, ultrasound
Rotation speed	From 0 up to 1200 rpm / Adjustable acceleration
Vertical oscillation	Up to 10 mm, adjustable
Ultrasound	50 W adjustable from 10 to 100%, 40 KHz with "Sweep" function
Principle	Turntable with 7 positions
Interface	7" touch-screen display
Voltage	230 V or 115 V

Accessories :

MSA	Item
19.708	(1) Active carbon filter module
19.715	(2) Active carbon cartridge for MSA19.708
19.705-A	(3) Vapour collector, for connecting to an external aspiration
19.706	(4) Portable surveying instrument PPM atex certified, with charger 230 V
19.711	(5) Glass tank with cover, Ø 114 x height 175 mm

Active carbon filter module.

The VIBRATO machine must be connected to a valid external extraction system or to our activated carbon filter module to ensure a safe environment in terms of occupational health and fire protection.

At the same time, the working room must be regularly ventilated. In any case, we advise you to analyse the environment room by a local accredited specialist.



VIBRATO



MSA	Voltage	Size	Kg
19.708	230 V 30 W	720 x 260 x 260 mm	15.000

The module is fixed to the rear of the VIBRATO machine. It is equipped with an independent fan to ensure permanent operation. It allows the recovery of almost all the solvent vapours coming out of the machine and ensures a long-lasting use in complete safety.

The active carbon cartridge is easily replaceable (bayonet system). Its lifetime depends on the intensity of use of the machine.

Fan capacity : 235 m3/hour.

Spare part :

MSA	Item	Kg
19.715	Active carbon cartridge for MSA19.708	3.540

VOC sensor (PID).



MSA	Size	Kg
19.706	61 x 66 x 59 mm	0.111

Compact and accurate PID sensor to monitor and optimise cartridge lifetime by simple reading.

It is estimated that under heavy use, the cartridge has a lifetime of 4-6 months.

<i>Sensitivity</i>	<i>0.001 ppm</i>
<i>PID lamp</i>	<i>10.6 eV</i>
<i>Range</i>	<i>0.001 - 5000 ppm</i>
<i>Alarm</i>	<i>Yes</i>
<i>Output</i>	<i>USB 2.0</i>

Vapour collector, for connecting to an external aspiration.



MSA
19.705-A

The collector is attached to the rear of the machine and must be connected to an external suction device (Ø 100 mm sleeve).

Baskets for cleaning machine, in polished stainless steel 304.



MSA	Size	Kg
19.572	Ø 80 x 53 mm	0.037

Lower basket holder.
Useful height 44 mm, total 53 mm.



MSA	Size	Kg
19.544	Ø 80 x 74 mm	0.060

Lower basket holder.
Useful height 66 mm, total 74 mm.



MSA	Size	Kg
19.705-P1	Ø 80 x 74 mm	0.110

Stainless steel upper basket holder.
Height 74 mm.



MSA	Size	Kg
19.795	Ø 80 x 3.20 mm	0.017

Cover for cleaning basket.
Height 3.20 mm ; mesh 0.20 mm.



MSA	Size	Kg
19.563	300 x 60 mm	0.029

Wave-breaker for glass beakers of cleaning machines.



MSA	Size	Kg
19.794	Ø 80 x 30.5 mm	0.022

Cleaning basket without division.
Useful height 26 mm, total 30.5 mm.



MSA	Size	Kg
19.790	Ø 80 x 14 mm	0.020

Cleaning basket without division.
Useful height 10 mm, total 14 mm.



MSA	Size	Kg
19.791	Ø 80 x 14 mm	0.026

Cleaning basket with 4 divisions.
Useful height 10 mm, total 14 mm, steel sheet separations thickness 0.5 mm.



MSA	Size	Kg
19.792	Ø 80 x 14 mm	0.037

Cleaning basket with 8 divisions.
Useful height 10 mm, total 14 mm, steel sheet separations thickness 0.5 mm.



MSA	Size	Kg
19.793	Ø 80 x 14 mm	0.038

Cleaning basket with 12 divisions + centre Ø 40 mm.
Useful height 10 mm, total 14 mm, steel sheet separations thickness 0.5 mm.

VIBRASONIC ACS-900 ultrasonic cleaning machines.

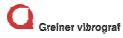

DELIVERED WITHOUT BASKETS

MSA	Voltage	Size	Kg
19.545	230 V	430 x 430 x 610 mm	32.900

VIBRASONIC ACS-900 automatic cleaning machine with 4 baths (including 1 ultrasonic bath).

Fully automatic and electronically activated alternative rotation.

Suitable with accessories Ø 80 mm.

Contents (Ø 80 mm) :

MSA	Item
19.550-U	Ultrasonic tank
19.551	(1) 3x Glass beaker
19.553	(2) 4x lid for glass beakers
19.563	(3) 3x wave-breaker for glass beakers, 300x60 mm
19.565	(4) Upper basket holder, for baskets Ø 80 mm
19.572	(5) Lower basket holder, for baskets Ø 80 mm

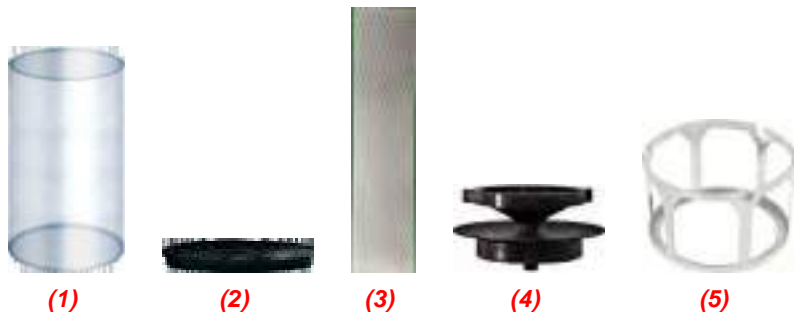

Spare parts :

MSA	Item
19.540-A	(1) Flexible hose, length 20...100 cm
19.540-B	Flexible hose, length 50...250 cm
19.540-P	Hose clamp
19.540-R	Fitting with screws



(1)



(2)

Special optional accessories available for MSA19.545 in Ø 80 mm :

MSA	Item	Kg
19.549	(1) Basket for 14 large dimensions main plates, thickness from 0.90 to 1.60 mm	0.090
19.549-A	(2) Set of main plates supports for MSA19.549	0.005

Optional accessories available for MSA19.545 in Ø 80 mm :



MSA	Item
19.569	1 Metal basket without divisions, height 10 mm
19.542	2 Metal basket with 2 divisions, height 10 mm
19.570	3 Metal basket with 4 divisions, height 10 mm
19.568	4 Metal basket with 8 divisions, height 10 mm
19.584	5 Metal basket with 9 divisions + centre Ø 40 mm, height 10 mm
19.567	6 Metal basket with 12 divisions, height 10 mm
19.571	7 Metal cover for metal baskets
19.580	10 Plastic basket without divisions + 1 metal basket MSA19.557, height 8 (14) mm
19.581	11 Plastic basket without divisions + 1 metal basket MSA19.556, height 8 (14) mm
19.582	12 Plastic basket without divisions + 1 metal basket MSA19.562, height 8 (14) mm
19.574	8 Plastic basket without divisions, height 8 mm
19.574-D	9 Plastic basket without divisions, height 8 mm, double wall
19.586	13 Plastic basket without divisions, height 16 mm
19.589	14 Plastic basket without divisions, height 24 mm
19.575	15 Plastic basket with 4 divisions, height 8 mm
19.587	16 Plastic basket with 4 divisions, height 8 mm, double wall
19.592	17 Plastic basket with 4 divisions, height 8 mm for 2 main plates Ø 25 mm
19.593	18 Plastic basket with 4 divisions, height 8 mm for 4 main plates Ø 31 mm
19.591	19 Plastic basket with 4 divisions, height 8 mm for 2 main plates Ø 38 mm
19.591-D	20 Plastic basket with 4 divisions, height 8 mm for 2 main plates Ø 38 mm, double wall
19.596	21 Plastic basket with 4 divisions, height 16 mm
19.578	22 Plastic basket with 6 divisions + 2 baskets MSA19.564, height 8 mm
19.579	23 Plastic basket with 6 divisions + 2 baskets MSA19.564 + 2 capsules MSA19.552, height 8 mm
19.576	24 Plastic basket with 8 divisions, height 8 mm
19.583	25 Plastic basket with 8 divisions, height 8 mm, double wall
19.599	26 Plastic basket with 8 divisions, height 8 mm, tight mesh
19.594	27 Plastic basket with 8 divisions + centre Ø 39 mm, height 8 mm
19.594-D	28 Plastic basket with 8 divisions + centre Ø 39 mm, height 8 mm, double wall
19.597	29 Plastic basket with 8 divisions, height 32 mm
19.577	30 Plastic basket with 12 divisions, height 8 mm
19.577-D	31 Plastic basket with 12 divisions, height 8 mm, double wall
19.595	32 Plastic basket with 16 divisions, height 8 mm
19.595-D	33 Plastic basket with 16 divisions, height 8 mm, double wall
19.590	34 Long plastic division for baskets MSA19.575 /19.576
19.573	35 Plastic cover for basket



MSA	Voltage	Size	Kg
19.550	230 V	420 x 420 x 560 mm	29.000
19.550-110	115 V	420 x 420 x 560 mm	29.000

VIBRASONIC ACS-900 automatic cleaning machine with 4 baths (including 1 ultrasonic bath).
Fully automatic and electronically activated alternative rotation.

Suitable with accessories Ø 64 mm.

Contents (Ø 64 mm) :

MSA	Item
19.550-U	Ultrasonic tank
19.551	(1) 3x Glass beaker
19.552	(3) 3x pair of plastic capsules, Ø 22 x 6 mm
19.553	(2) 4x lid for glass beakers
19.554	(4) Upper basket holder, for baskets Ø 64 mm
19.555	(5) Lower basket holder, for baskets Ø 64 mm
19.556	(6) 2x metal basket with 4 divisions, height 15 mm
19.557	(7) Metal basket without divisions, height 15 mm
19.558	(8) Metal cover for baskets MSA19.556 and 19.557
19.559	(9) Support with 1 axis for 5 movement holders
19.560	(10) 5x movement holder for 3 movements
19.563	(11) 3x wave-breaker for glass beakers, 300x60 mm

DELIVERED WITH BASKETS Ø 64 mm



Special optional accessories available for MSA19.550 in Ø 64 mm :



MSA	Item
19.541	(1) Movement holder for 6 movements
19.561	(2) Upper basket holder with clamp (also suitable for Ø 80 mm)
19.562	(3) Basket with 5 divisions, height 14 mm
19.564	(4) Basket with lid, Ø 20 x height 13 mm



Spare parts :

MSA	Item
19.540-A	(1) Flexible hose, length 20...100 cm
19.540-B	Flexible hose, length 50...250 cm
19.540-P	Hose clamp
19.540-R	Fitting with screws



(1)

(2)

(3)

(4)

Other accessories for cleaning machines :

MSA	Item	Kg
19.531	(1) Brass cleaning basket with screw-on cover without division, Ø 14 - height 8.30 mm	0.005
19.725	(2) Brass cleaning basket with screw-on cover without division, Ø 16 - height 12.50 mm	0.007
19.726	(3) Brass cleaning basket with screw-on cover without division, Ø 14 - height 9.50 mm	0.004
19.727	(4) Brass cleaning basket with screw-on cover without division, Ø 23 - height 12.50 mm	0.010

Ultrasonic cleaning machines SONOSWISS®.



MSA	Model	Volume	Voltage	Power	Int. size (tank)	Heating	Drain	Cover	Handles	Kg
19.880	SW 1H	0.80 L	220-240 V	90 W	190x85x60 mm	With	Without	Without	Without	2.000
19.880-110	SW 1H	0.80 L	100-120 V	90 W	190x85x60 mm	With	Without	Without	Without	2.000
19.881	SW 3H	2.75 L	220-240 V	280 W	235x134x97 mm	With	Without	Without	With	2.800
19.881-110	SW 3H	2.75 L	100-120 V	280 W	235x134x97 mm	With	Without	Without	With	2.800
-	-	-	-	-	-	-	-	-	-	-
19.882	SW 3H	2.75 L	220-240 V	280 W	235x134x97 mm	With	With	Without	With	2.800
19.882-110	SW 3H	2.75 L	100-120 V	280 W	235x134x97 mm	With	With	Without	With	2.800
19.883	SW 6H	5.75 L	220-240 V	550 W	298x150x150 mm	With	With	Without	With	4.800
19.883-110	SW 6H	5.75 L	100-120 V	550 W	298x150x150 mm	With	With	Without	With	4.800
-	-	-	-	-	-	-	-	-	-	-
19.884	SW 12H	12.75 L	220-240 V	1000 W	297x238x200 mm	With	With	Without	With	7.300
19.884-110	SW 12H	12.75 L	100-120 V	1000 W	297x238x200 mm	With	With	Without	With	7.300
-	-	-	-	-	-	-	-	-	-	-
19.885	SW 18H	18 L	220-240 V	1000 W	330x300x200 mm	With	With	Without	With	8.200
19.885-110	SW 18H	18 L	100-120 V	1000 W	330x300x200 mm	With	With	Without	With	8.200
-	-	-	-	-	-	-	-	-	-	-
19.886	SW 30H	28 L	220-240 V	1500 W	500x298x200 mm	With	With	Without	With	11.200
19.886-110	SW 30H	28 L	100-120 V	1500 W	500x298x200 mm	With	With	Without	With	11.200

Ultrasonic cleaning apparatus PRESET.

- Programmable ultrasonic generator : possibility to save a wash program
- DEGAS function : the special deformation of the ultrasonic wave accelerates the degassing of the liquid
- BOOST function : this mode is used to temporarily increase the ultrasound power in case of persistent contaminants
- SWEEP function : the frequency scanning is automatically switched for a better distribution of the ultrasonic power
- The heating temperature is adjustable in 5° C increments up to 80° C
- The ultrasound duration from 1-5 minutes in 1-minute increments or 5-30 minutes in 5-minute increments.

Stainless steel tank. Delivered without lid or basket.

Accessories for SONOSWISS® ultrasonic cleaning machines.

SONOSWISS



MSA	For
19.660-A	MSA19.880 (SW 1H)
19.662-A	MSA19.881 + MSA19.882 (SW 3H)
19.664-A	MSA19.883 (SW 6H)
19.665-A	MSA19.884 (SW 12H)
19.885-A	MSA19.885 (SW 18H)
19.666-A	MSA19.886 (SW 30H)

Plastic cover, can also be used as a tray for the wet basket.

SONOSWISS



MSA	For
19.660-B	MSA19.880 (SW 1H)
19.662-B	MSA19.881 + MSA19.882 (SW 3H)
19.664-B	MSA19.883 (SW 6H)
19.665-B	MSA19.884 (SW 12H)
19.885-B	MSA19.885 (SW 18H)
19.666-B	MSA19.886 (SW 30H)

Stainless steel basket.



MSA	Size
19.655	Ø 59 x 60 mm
19.680	Ø 78 x 60 mm

Stainless steel immersion basket.



MSA	For
19.612	(a) MSA19.880
19.652	(b) MSA19.881 + MSA19.882
19.681	(b) MSA19.883 + MSA19.884 + MSA19.885 + MSA19.886

Stainless steel tray for 2 beakers.

- (a) For beakers Ø 80 mm
- (b) For beakers Ø 95 mm.



MSA
19.633-C

Flexible plastic jewellery rack with 8 adjustable hooks.
Length 305 mm.



MSA	Size
-----	------

19.614	Ø 80 mm (600 ml)
19.640-F	Ø 95 mm (600 ml)

Glass beaker with cover and ring.



Spare parts :

MSA	Item
-----	------

19.683	Cover for MSA19.640-F
19.686	Cover for MSA19.614

SOUND CLEANS
Ultrasonic cleaning technology



MSA

19.682

Set of 2 glass beakers Ø 80 mm (600 ml) with lids and 1 tray for MSA19.880.

Professional steam cleaner XRVP PRO.



- (1) : using the 5-litre water supply tank provided.**
- (2) : via a direct connection to the public water mains supply.**
- In both cases, the hot filling is possible.**

MSA		Voltage	Size	Kg
19.712	(1)	230 V 50 Hz	322 x 365 x 330 mm	9.000
19.713	(2)	230 V 50 Hz	322 x 365 x 330 mm	9.000

Professional steam cleaner PXRVP PRO.
 Its use is recommended in watchmaking and jewellery for the cleaning of all types of parts. Polishing residues, resin, oil, etc., are easily eliminated and without any toxic products thanks to the adjustable steam jet from 0 to 10 bar. The device has an integrated anti-limestone system and the steam can be generated without any fear by the public water supply. The steam production is constant with a very low-pressure drop even in a continuous service. The device also allows generating wet or dry steam (by selection).

Delivered with 1 flexible handpiece with nozzle (1.3 metres) and 3 pre-drilled nozzles.
 Note: when ordering, remember to define the filling mode of the device. Delivered without pedal.

Option :

MSA	Item
19.712-01	Pedal

Technical data :

Colour	Stainless steel
Steam production	Continuous flow
Boiler stem temperature	171° C
Heating time	5 minutes
Pressure (bar)	Up to 10 bar
Boiler power consumption (W)	3200
Boiler volume (litres)	2
Steam EV1 (gr/min.)	36 gr/min. minimum regulation - 76 gr/min. maximum regulation
Boiler material	Stainless steel AISI 304
Steam regulation on steam hose	No
Total power consumption (W)	3200
Tank capacity (litres)	5
Water level alarm	Visual and acoustic
Pressure indicator	Visual
Hot water injection + steam (gr/min.)	173 gr/min. minimum regulation - 224 gr/min. maximum regulation
Water pump power	48 W
Low tension voltage on handgrip	9 V
Power cable	7 metres
Certification reached	CE



MSA	Volume	Kg
26.754	500 ml	0.540

Anti-limestone product.

Cleaning machines ELMA® ELMASOLVEX.



DELIVERED WITHOUT BASKETS

MSA	Voltage	Size	Kg
19.501	230 V	502 x 516 x 650 mm	19.000
19.501-110	115 V	502 x 516 x 650 mm	19.000

ELMASOLVEX SE is a manual multiple chamber cleaning machine for watch movements and mechanical precision parts. Water and solvent based cleaning and rinsing media. Equipped with four cleaning chambers and one drying chamber with fine filter hot air technology, this machine achieves perfect cleaning results.

Delivered with basket holders, beakers and wave-breaker.



DELIVERED WITHOUT BASKETS

MSA	Voltage	Size	Kg
19.502	230 V	515 x 542 x 650 mm	28.000
19.502-110	115 V	515 x 542 x 650 mm	28.000

ELMASOLVEX RM is a completely automatic multiple chamber cleaning machine with integrated explosion protection. For watch movements and other mechanical precision parts. Water and solvent based cleaning and rinsing media. Cleaning and rinsing are performed completely automatically or alternatively with individually adjustable parameters in the rotation or oscillation process in four cleaning chambers. An integrated drying chamber with fine filter hot air technology completes the residue-free cleaning.

Delivered with basket holders, beakers and wave-breaker.

Spare parts for MSA19.501 and MSA19.502 in Ø 64 mm :

MSA	Item
19.521-A	Beaker lid with cork gasket
19.521-B	Cork gasket for lid
19.521-D	CPL heating plate
19.521-E	Heater/Motor switch
19.530-B	Set including basket holder MSA19.530-L, basket MSA19.530-M, 2 baskets MSA19.530-J, small basket MSA19.530-G, lid MSA19.530-F, lid MSA19.530-H
19.530-C	Basket Ø 64 mm, height 15 mm, with 4 divisions
19.530-D	Basket Ø 64 mm, height 15 mm, with 9 divisions
19.530-E	Basket Ø 64 mm, height 45 mm, without division
19.530-F	Lid Ø 64 mm for baskets
19.530-G	Small basket Ø 20 mm, without lid
19.530-H	Lid Ø 20 mm for small basket
19.530-J	Basket Ø 64 mm, height 15 mm, with 5 divisions
19.530-L	Lower basket holder
19.530-M	Basket Ø 64 mm, height 15 mm, without division
19.530-N	Movement holder for 6 movements
19.530-P	Small basket Ø 20 mm, with lid
19.530-S	Beaker with lid + gasket + wave-breaker, volume 600 ml
19.530-T	Beaker, volume 600 ml
19.530-U	Lid for beaker MSA19.530-S
19.530-V	Gasket for beaker MSA19.530-S
19.530-W	Wave-breaker for beaker MSA19.530-S

Drying units ELMA® ELMADRY.



MSA	Voltage	Working capacity	Heating power	External size mm	Internal size mm	Max. load	Kg
19.617	220 - 240 V	1.9 L	480 W	300 x 186 x 219	240 x 137 x 100	1 Kg	3.600
19.617-110	110 V	1.9 L	480 W	300 x 186 x 219	240 x 137 x 100	1 Kg	3.600
-	-	-	-	-	-	-	-
19.618	220 - 240 V	9.0 L	550 W	362 x 285 x 322	300 x 240 x 200	7 Kg	6.100
19.618-110	110 V	9.0 L	550 W	362 x 285 x 322	300 x 240 x 200	7 Kg	6.100
-	-	-	-	-	-	-	-
19.619	220 - 240 V	20.6 L	1100 W	568 x 347 x 322	505 x 300 x 200	12 Kg	10.200
19.619-110	110 V	20.6 L	1100 W	568 x 347 x 322	505 x 300 x 200	12 Kg	10.200

ELMADRY TD drying unit is available in 3 sizes (30, 120 and 300) and designed for use in production, workshop and service. After ultrasonic cleaning, the parts are first rinsed in the basket with running water and then simply placed in the drying unit. Fitted with cold and hot air blower (70° C), sensitive parts can also be dried gently. In cold air operation, the parts to be dried can also be cooled quickly.

The hot air function is activated while the cover is on. The cover has ventilation slots, ensuring that maximum air turbulence is produced, and the moist air is conducted to the outside. At the same time, the cover reduces energy consumption.

The dust filter on the underside is replaceable and prevents re-soiling of the cleaned parts by the dust in the room air.

Optional :

MSA	Item
19.611-A	Perforated silicone mat for MSA19.617
19.611-B	Perforated silicone mat for MSA19.618 and MSA19.619
19.626	Dust filter for MSA19.617, MSA19.618 et MSA19.619

Optional baskets available :

- For MSA19.617 (TD 30): MSA19.660-B (1 litre) and MSA19.662-B (3 litres)
- For MSA19.618 (TD 120): MSA19.664-B (6 litres) and MSA19.665-B (12 litres)
- For MSA19.619 (TD 300): MSA19.666-B (30 litres).

MULTIVAC® professional chamber machine.



MSA	Type	Voltage	Chamber size
19.741	(a) P200 without gas	220-240 V / 50 Hz	305 x 300 x 110 mm
19.742	(a) P200 with gas	220-240 V / 50 Hz	305 x 300 x 110 mm
19.743	(a) C100 without gas	220-240 V / 50 Hz	330 x 310 x 120 mm
19.744	(a) C100 with gas	220-240 V / 50 Hz	330 x 310 x 120 mm
19.745	(b) C200 without gas	220-240 V / 50 Hz	490 x 355 x 150 mm
19.746	(b) C200 with gas	220-240 V / 50 Hz	490 x 355 x 150 mm
19.747	(c) C250 without gas	220-240 V / 50 Hz	490 x 285 x 150 mm
19.748	(c) C250 with gas	220-240 V / 50 Hz	490 x 285 x 150 mm

Professional chamber machine.

(a) 2 nozzles (b) 4 nozzles (c) 8 nozzles

Type P : time regulated vacuum level
Type C : probe regulated vacuum level in %.

Spare parts :

MSA	Item
19.738	Nitrogen pressure regulator with 2-metre hose
19.739	Argon pressure regulator with 2-metre hose

Technical information of the chamber machines MSA19.74x :

Equipment	MSA19.740 (1)	MSA19.741 (1)	MSA19.742 (1+2)	MSA19.743 (1)	MSA19.744 (1+2)	MSA19.745 (1)	MSA19.746 (1+2)	MSA19.747 (1)	MSA19.748 (1)
Sealing bar	Snap-in 205 mm	Snap-in 305 mm	Snap-in 305 mm	305 mm	305 mm	465 mm	465 mm	465 mm (2 parallel bars)	465 mm (2 parallel bars)
Double sealing with underside pre-cutting	1x 3 mm 1x 1 mm	1x 3 mm 1x 1 mm	1x 3 mm 1x 1 mm	1x 3 mm 1x 1 mm	1x 3 mm 1x 1 mm	1x 3 mm 1x 1 mm	1x 3 mm 1x 1 mm	1x 3 mm 1x 1 mm on the 2 bars	1x 3 mm 1x 1 mm on the 2 bars
Vacuum pump	4 m3/h	8 m3/h	8 m3/h	MRP 15	MRP 15	MRP 25	MRP 25	MRP 25	MRP 25
Filling plate in resin	✓ (2x)	✓ (2x)	✓ (2x)	✓	✓	✓	✓	✓	✓
Transparent plexiglas cover	✓	✓	✓						
Window control in the safety glass lid				✓	✓	✓	✓	✓	✓
Electronic control	MCB 01	MCB 01	MCB 01	MC06-K20	MC06-K20	MC06-K20	MC06-K20	MC06-K20	MC06-K20
Automatic progressive atmosphere	✓	✓	✓	✓	✓	✓	✓	✓	✓
Vacuum quick- stop button				✓	✓	✓	✓	✓	✓

Accessories :
(1) Mobile stand, 4 wheels (2 swivels), with pouch shelf
(2) Gas flushing system



In a 500-piece bag :

MSA	Quantity	Size 1 x 2
17.706-250X500	500	250 x 500 mm
17.706-250X600	500	250 x 600 mm
17.706-260X450	500	260 x 450 mm
17.706-300X500	500	300 x 500 mm
17.706-300X600	500	300 x 600 mm
17.706-300X700	500	300 x 700 mm

Special plastic bag (PA/PE 20/70) for chamber machines.

In a 1000-piece bag :

MSA	Quantity	Size 1 x 2
17.706-100X250	1000	100 x 250 mm
17.706-100X300	1000	100 x 300 mm
17.706-120X120	1000	120 x 120 mm
17.706-120X160	1000	120 x 160 mm
17.706-120X200	1000	120 x 200 mm
17.706-120X270	1000	120 x 270 mm
17.706-120X300	1000	120 x 300 mm
17.706-120X400	1000	120 x 400 mm
17.706-130X180	1000	130 x 180 mm
17.706-130X200	1000	130 x 200 mm
17.706-130X280	1000	130 x 280 mm
17.706-130X300	1000	130 x 300 mm
17.706-130X380	1000	130 x 380 mm
17.706-140X200	1000	140 x 200 mm
17.706-140X210	1000	140 x 210 mm
17.706-140X270	1000	140 x 270 mm
17.706-150X180	1000	150 x 180 mm
17.706-150X200	1000	150 x 200 mm
17.706-150X230	1000	150 x 230 mm
17.706-150X260	1000	150 x 260 mm
17.706-160X200	1000	160 x 200 mm
17.706-160X300	1000	160 x 300 mm
17.706-165X210	1000	165 x 210 mm
17.706-165X250	1000	165 x 250 mm
17.706-170X250	1000	170 x 250 mm
17.706-170X400	1000	170 x 400 mm

MSA	Quantity	Size 1 x 2
17.706-180X230	1000	180 x 230 mm
17.706-180X240	1000	180 x 240 mm
17.706-180X250	1000	180 x 250 mm
17.706-180X260	1000	180 x 260 mm
17.706-180X280	1000	180 x 280 mm
17.706-180X350	1000	180 x 350 mm
17.706-200X220	1000	200 x 220 mm
17.706-200X250	1000	200 x 250 mm
17.706-200X300	1000	200 x 300 mm
17.706-200X350	1000	200 x 350 mm
17.706-200X400	1000	200 x 400 mm
17.706-200X500	1000	200 x 500 mm
17.706-200X600	1000	200 x 600 mm
17.706-220X300	1000	220 x 300 mm
17.706-225X350	1000	225 x 350 mm
17.706-230X380	1000	230 x 380 mm
17.706-250X280	1000	250 x 280 mm
17.706-250X300	1000	250 x 300 mm
17.706-250X350	1000	250 x 350 mm
17.706-250X400	1000	250 x 400 mm
17.706-260X350	1000	260 x 350 mm
17.706-270X300	1000	270 x 300 mm
17.706-300X300	1000	300 x 300 mm
17.706-300X350	1000	300 x 350 mm
17.706-300X400	1000	300 x 400 mm
17.706-320X320	1000	320 x 320 mm

Special plastic bag (PA/PE 20/70) for chamber machines.



MSA	Version	Voltage	Size	Kg
19.850	Up to 10 benches	220 V	500 x 700 x 800 mm	100.000

AIRcenter is a system which combines air pressure and vacuum in 1 machine adapted to final watch assembling as well as the after sales service using small and medium quantity of air. All-in-one concept, which doesn't require fixed air main masonry and electricity settlement. Flexible and easy to move wherever in the watch shop.

Bench air supply is made with soft pipes and individual pedal for each work place. Oil free motor which gives high air quality. It functions without using any pedals.

Technical data :

- Air pressure max. : 8 bar
- Vacuum : 800 mbar
- Air tank volume : 16 litres
- Vacuum tank volume : 40 litres
- Noise level : 50 dB
- Connections : 2x AC and 1x vacuum.

Delivered with air drier MSA19.850-02 (8) and recovery bowl MSA19.850-01.

(8) Accessories : see following pages.

This machine is only available on the Swiss market.



MSA	Version	Size	Kg
19.875	1 work station	160 x 220 x 85 mm	1.700

Air flow/vacuum device for 1 work station.

This device requires a compressor to operate.

The integrated Venturi system transforms the forced air in vacuum.

Delivered with :

- 1 pedal MSA19.875-B
- 1 filter MSA19.875-A
- 1 hose Ø 6x4 mm MSA19.826, length 3 metres
- 1 hose Ø 8x5.5 mm MSA19.851, length 3 metres
- 1 transparent hose Ø 10x6 mm MSA19.812, length 3 metres.

Accessories :

MSA	Item	Kg
19.875-A	Filter	0.004
19.875-B	Pedal	0.200
19.875-C	Male manometer 1/8 Transair	0.035

See following pages for other accessories.

(a) Vacuum pencil not included in delivery



MSA	Version	Voltage	Size	Kg
19.808	2 work stations	220 V	295 x 200 x 220 mm	8.300
19.808-110	2 work stations	110 V	295 x 200 x 220 mm	8.300

System with vacuum. Oil free engine, very noise-less and compatible for use in a white room.

Technical data :

- Flow 2300 litres/hour
- Absolute empty value : 80 mbar
- Pressure 1 bar uninterrupted (maximum 2.8 bar)
- Noise level : 48 dB.

VACUUM FUNCTION

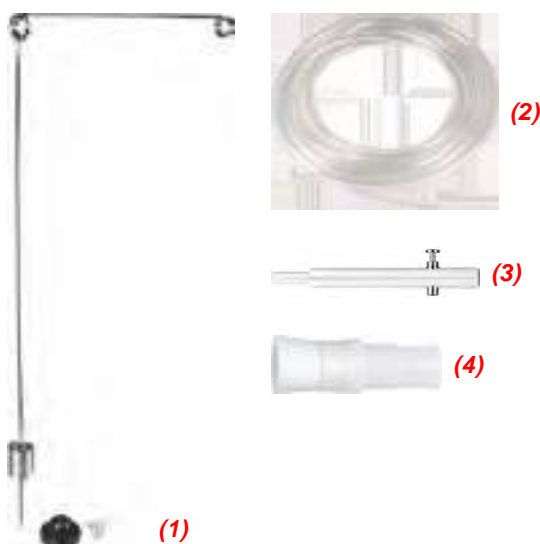

Items delivered with MSA19.808 :

MSA	Item	Kg
19.811	(3) Vacuum pencil (2x)	0.011
19.812	(2) Transparent PVC hose, Ø int. 6 x Ø 10 mm (2x 3 metres)	0.100
19.813	(4) Soft brush (2x)	0.005
19.816	(1) Stand with base and fixing screws (2x)	0.080



MSA	Version	Voltage	Size	Kg
19.807	1 work station	220 V	295 x 200 x 220 mm	8.300
19.807-110	1 work station	110 V	295 x 200 x 220 mm	8.300

System with vacuum. Oil free engine, very noise-less and compatible for use in a white room.

Technical data :

- Flow 2300 litres/hour
- Absolute empty value : 80 mbar
- Pressure 1 bar uninterrupted (maximum 2.8 bar)
- Noise level : 48 dB.

Items delivered with MSA19.807 :

MSA	Item	Kg
19.811	(3) Vacuum pencil (1x)	0.011
19.812	(2) Transparent PVC hose, Ø int. 6 x Ø 10 mm (1x 3 metres)	0.100
19.813	(4) Soft brush (1x)	0.005
19.816	(1) Stand with base and fixing screws (1x)	0.080

VACUUM FUNCTION



MSA	Version	Voltage	Size	Kg
19.820	1 work station	220 V	295 x 200 x 220 mm	9.400
19.820-110	1 work station	110 V	295 x 200 x 220 mm	9.400

System with double function air pressure and vacuum.
Oil free engine, very noise-less and compatible for use in a white room.
One work station with 2 foot switches and 1 recovery bowl.

Technical data :

- Flow 2300 litres/hour
- Absolute empty value : 80 mbar
- Pressure 1 bar uninterrupted (maximum 2.8 bar)
- Noise level : 48 dB.

**DOUBLE FUNCTION
AIR PRESSURE AND VACUUM**

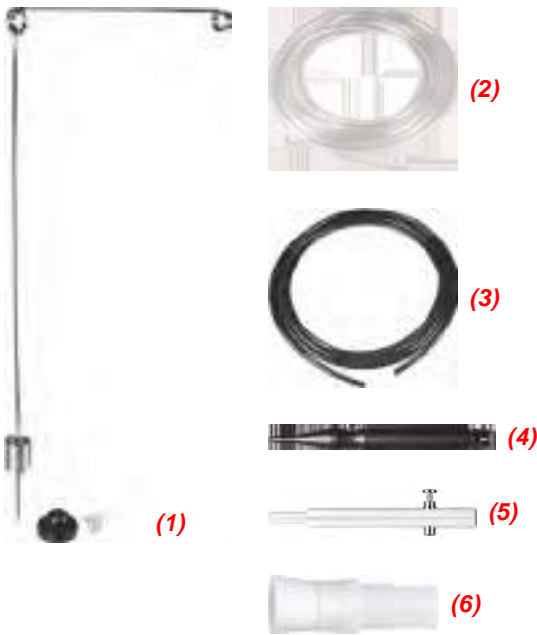

Items delivered with MSA19.820 :

MSA	Item	Kg
19.811	(5) Vacuum pencil (1x)	0.011
19.812	(2) Transparent PVC hose, Ø int. 6 x Ø 10 mm (1x 3 metres)	0.100
19.813	(6) Soft brush (1x)	0.005
19.816	(1) Stand with base and fixing screws (2x)	0.080
19.817	(4) Blower (1x)	0.016
19.826	(3) Black hose, Ø 6x4 mm (1x 1 metre)	0.045

Accessories (regulation and filtration) for MSA19.807, MSA19.808, MSA19.820 and MSA19.850 :

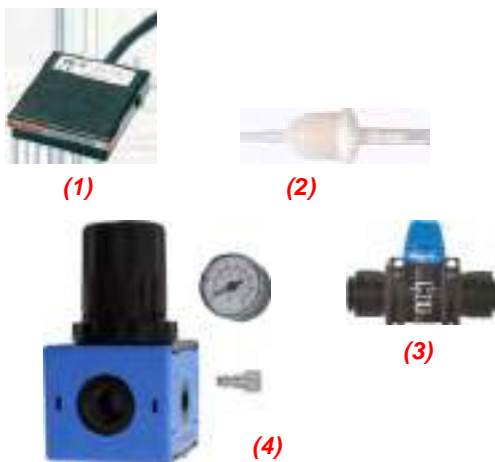

MSA	Item
19.808-P	(1) Pedal for MSA19.807 and 19.808
19.822	(2) Pump filter
19.838	(3) Mini-ball valve 2/2 instant in-line, Ø 10 mm
19.859	(4) Pressure regulateur with manometer and fitting Ø 6 mm



Accessories for vacuum/compressed air devices :

MSA	Item	Kg
19.811	(1) Vacuum pencil, Ø 10 x L90 mm	0.011
19.833	(2) Air proof vacuum pencil for MSA19.850 only	0.015
19.877	(3) Vacuum pencil with fitting 45° for hose Ø 8 mm	0.015
19.878	(4) Vacuum pencil with straight fitting for hose Ø 8 mm	0.015
19.817	(5) Blower	0.016
19.856	(6) Blower with fitting 45°	0.022
19.846-10	(7) Suction end piece for vacuum pencil, Ø 10 mm	0.004
19.846-15	(7) Suction end piece for vacuum pencil, Ø 15 mm	0.004
19.846-20	(7) Suction end piece for vacuum pencil, Ø 20 mm	0.004
19.846-25	(7) Suction end piece for vacuum pencil, Ø 25 mm	0.005
19.813-A	Soft brush white nylon, Ø 6 mm	0.005
19.813	(8) Soft brush white nylon, Ø 10 mm	0.005
19.823	(8) Soft brush white nylon, Ø 15 mm	0.005
19.867	(8) Soft brush white nylon, Ø 25 mm	0.005
19.868	(8) Soft brush white nylon, Ø 35 mm	0.005
19.814	(9) Hard brush blue nylon, Ø 10 mm	0.005
19.814-A	Soft brush blue nylon, Ø 6 mm	0.005
19.847	Very hard brush red nylon, Ø 10 mm	0.005
19.825	(10) Badger-hair brush, Ø 10 mm	0.005
19.825-15	(10) Badger-hair brush, Ø 15 mm	0.005
19.819	(11) Marten-hair brush, Ø 10 mm	0.005
19.832	(11) Marten-hair brush, Ø 15 mm	0.005
19.821	(12) Beak 45° with nylon filter	0.006
19.824	(13) Thin long beak 25 mm, Ø 2.3 mm	0.004
19.824-A	(14) Thin short beak, Ø 2.3 mm x L15 mm	0.003
19.824-C	(14) Thin long elbow 45° beak, Ø 2.3 mm x L45.20 mm	0.004
19.829	(15) Medium short beak, Ø 4 mm x L15 mm	0.003
19.829-A	(16) Medium short beak, Ø 6 mm x L15 mm	0.003

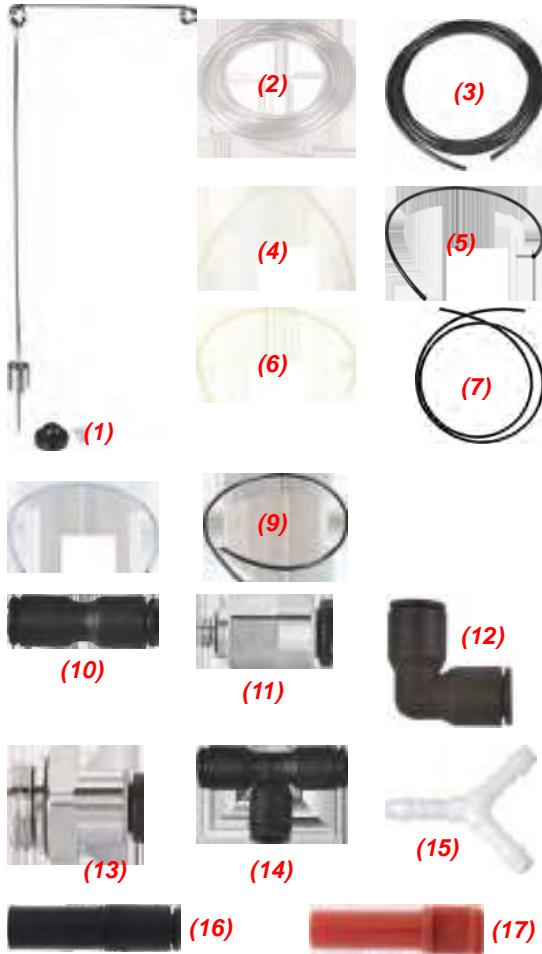

Connections for vacuum/compressed air devices :

MSA	Item	Kg
19.816	(1) Stand with base and fixing screws	0.080
19.812	(2) Transparent PVC hose, Ø int. 6 x Ø 10 mm x 1 metre	0.100
19.826	(3) Black hose, Ø 6x4 mm x 1 metre	0.045
19.834	(4) Transparent hose, Ø 14x12 mm x 1 metre	0.030
19.840	(5) Soft black PVC hose, Ø 10x7 mm x 1 metre	0.022
19.841	(6) Semi-rigid white polyamide hose, Ø 4x2.7 mm x 25 metres	0.046
19.842	(7) Soft black PVC hose, Ø 4x2.5 mm x 1 metre	0.013
19.848	(8) Soft grey hose, Ø 12x8 mm x 1 metre	0.090
19.851	(9) Black hose, Ø int. 5.5 x Ø 8 mm x 1 metre	0.040
19.828-A	(10) Straight fitting, Ø 6 mm	0.005
19.828-B	(10) Straight fitting, Ø 10 mm	0.005
19.830	(11) Straight male fitting D6 for blower, M5	0.005
19.830-B	(12) 90° angle fitting, Ø 10 mm	0.006
19.830-D	(12) 90° angle fitting, Ø 14 mm	0.015
19.830-G1/4	(13) Quick fitting G 1/4, Ø 6 mm	0.010
19.827-A	(14) "T" fitting, Ø 6 - 6 - 6 mm	0.005
19.827-B	(14) "T" fitting, Ø 10 - 10 - 10 mm	0.011
19.827-C	(14) "T" fitting, Ø 14 - 14 - 14 mm	0.008
19.827-D	(14) "T" fitting, Ø 12 - 12 - 12 mm	0.022
19.815	(15) "Y" fitting, Ø 6 mm	0.005
19.839-A	(16) Reducer, 10-6 mm	0.003
19.839-B	(16) Reducer, 14-10 mm	0.006
19.839-C	(16) Reducer, 12-6 mm	0.006
19.835-A	(17) Hose plug Ø 6 mm	0.001
19.835-B	(17) Hose plug Ø 10 mm	0.002
19.835-C	(17) Hose plug Ø 14 mm	0.006
19.835-D	(17) Hose plug Ø 12 mm	0.004
19.811-F	Intermediate filter for vacuum brush	0.005
19.873	In-line filter for compressed air with straight fittings Ø 6 mm	0.054

Automatic adhesive dispenser system.



MSA	Voltage	Size	Kg
19.770	DUAL 110 - 220 V	150 x 165 x 178 mm	1.200

Automatic dispenser TS250, which accurately and consistently dispenses low, medium and high viscosity fluids and adhesives thanks to syringes of 10 ml. This dispensing system includes digital display timer allowing a deposit time precision of 0.001 second. Works in manual, sequence and automatic modes and is able to dispense in drops, lines and pot filling.

Technical data :
 DUAL power source 110/220 V, air source maximum 6.9 bar (100 PSI) and applicable air pressure 0.1-6.9 bar (1-100 PSI).

Delivered with foot switch, 1 syringe barrel stand, 1 connection kit for syringes 10 ml, 1 assortment of syringes, air hose and operation instructions.

Assortment of tips for MSA19.770.



MSA
19.770-KIT

Assortment of tips in a box for MSA19.770.

Accessories for MSA19.770.



MSA	Items
19.774-03	Adapter for syringe 3 ml + hose 90 cm
19.775-A	Adapter for syringe 5 ml + hose 90 cm
19.775-B	Adapter for syringe 10 ml + hose 90 cm
19.760-O	Cap for MSA19.760-Q, 30 pieces
19.773-03-B	Cap for MSA19.773-03
19.775-05-B	(1) Cap for MSA19.775-S
19.760-S	(2) End cap for MSA19.760-Q, MSA19.760-R, MSA19.773-03 and MSA19.775-S, 50 pieces
19.774-04	O'Ring gasket for adapter 3 ml
19.775-05	O'Ring gasket for adapter 5 ml
19.775-10	(3) O'Ring gasket for adapter 10 ml
19.773-03-P	Piston for MSA19.773-03, 50 pieces
19.775-05-P	Piston for MSA19.775-S, 50 pieces
19.773-03	Transparent syringe 3 ml
19.775-S	Transparent syringe 5 ml
19.760-Q	Transparent syringe 10 ml
19.760-R	(4) Black syringe 10 ml
19.772	Syringe holder

Dispensing tips for MSA19.770.



MSA	Needle	Colour	Ø	Kg
19.770-M007	Straight metal	Green	0.07 mm	0.001
19.770-M010	"	Yellow	0.10 mm	0.001
19.770-M015	"	Lavender	0.15 mm	0.001
19.770-M020	"	Transparent	0.20 mm	0.001
19.770-M025	"	Red	0.25 mm	0.001
19.770-M033	"	Orange	0.33 mm	0.001
19.770-M041	"	Blue	0.41 mm	0.001
19.770-M051	"	Purple	0.51 mm	0.001
19.770-M061	"	Pink	0.61 mm	0.001
19.770-M084	"	Green	0.84 mm	0.001
19.770-M137	"	Amber	1.37 mm	0.001
19.770-M160	"	Olive	1.60 mm	0.001
-	-	-	-	-
19.770-C020	Conical plastic	Transparent	0.20 mm	0.001
19.770-C025	"	Red	0.25 mm	0.001
19.770-C041	"	Blue	0.41 mm	0.001
19.770-C061	"	Pink	0.61 mm	0.001
19.770-C084	"	Green	0.84 mm	0.001
19.770-C119	"	Grey	1.19 mm	0.001
19.770-C160	"	Olive	1.60 mm	0.001
-	-	-	-	-
19.770-A015	Metal 90°	Lavender	0.15 mm	0.001
19.770-A020	"	Transparent	0.20 mm	0.001
19.770-A025	"	Red	0.25 mm	0.001
19.770-A033	"	Orange	0.33 mm	0.001
19.770-A041	"	Blue	0.41 mm	0.001
19.770-A051	"	Purple	0.51 mm	0.001
19.770-A061	"	Pink	0.61 mm	0.001
19.770-A084	"	Green	0.84 mm	0.001
19.770-A137	"	Amber	1.37 mm	0.001
19.770-A160	"	Olive	1.60 mm	0.001
-	-	-	-	-
19.770-B015	Metal 45°	Lavender	0.15 mm	0.001
19.770-B020	"	Transparent	0.20 mm	0.001
19.770-B025	"	Red	0.25 mm	0.001
19.770-B033	"	Orange	0.33 mm	0.001
19.770-B041	"	Blue	0.41 mm	0.001
19.770-B051	"	Purple	0.51 mm	0.001
19.770-B061	"	Pink	0.61 mm	0.001
19.770-B084	"	Green	0.84 mm	0.001
19.770-B137	"	Amber	1.37 mm	0.001
19.770-B160	"	Olive	1.60 mm	0.001

Volumetric dosing machine.

LOCTITE



MSA	Voltage	Size	Kg
19.761	DUAL 110 - 220 V	192 x 210 x 90 mm	3.000

The timing and the dosing rate are freely programmable. It is possible to take the product directly from a bottle or other recipient.

Technical data :

DUAL power source 110 - 220 V (different cable for 110 V network) and consumption of 10 W.

Delivered with dosing box, several types of pipes and the corresponding adapters and a user's manual.



MSA	Voltage	Size	Kg
19.762	220 V	305 x 525 x 575 mm	17.000

The UVALOC 1000 is a modular tabletop unit for curing adhesives and sealants.

The system has a parabolic reflector, a pneumatically operated screen, a polycarbonate chamber door (UV filter) with a safety lock.

The control unit has a programmable control with a display. The lamp is changed by a drawer system.

The system is equipped with a 1000 W lamp in accordance with current standards in order to achieve the required 1000 W lamp to achieve deep curing and dry surfaces. The service life of the lamps varies depending on the type chosen, from 700 to 1500 hours.

Technical data : 220 V power supply, power consumption approx. 1200 W and emission spectrum 200 to 400 nm.

Delivered with 1 controller, 1 polymerisation chamber, 1 lamp compartment connection cable, 1 power cord, 1 foot switch and 1 instruction manual.

Spare parts :

MSA	Item	Kg
19.762-A	000	0.100
19.762-B	000	0.100
19.762-C	000	0.100



MSA	Voltage	Size	Kg
19.751	220 V	255 x 155 x 485 mm	5.800
19.751-110	110 V	255 x 155 x 485 mm	5.800

Apparatus for polymerisation of UV-active adhesives and resins. Suitable for optics, jewellery and watch industries as well as Watch Lab, workshop and small series for sealing case glasses.

It is equipped with a safety device, which stops UV radiation in case the drawer is opened.

Technical data : power source 220 or 110 V (upon request), consumption 75 W and emission spec-trum from 350 to 400 nm.



MSA	Voltage	Size	Kg
19.765	220 V	215 x 240 x 100 mm	1.800

UV lamp tunnel for fast drying watch glass UV glue. Power 36W.

3 programmable timing modes :

Position (I) : 90 seconds

Position (II) : 120 seconds

Position (0) : stop.

Delivered with 4 tubes of 9 W (should work simul-taneously).

Spare part :

MSA	Item	Kg
19.765-A	9 W UV tube	0.040













Demagnetisation, detection of magnetism and control of magnetic remanence.



MSA	Voltage	Size	Kg
19.910	DUAL 115 - 230 V	155 x 172 x 55 mm	1.235

Electronic device MAGTEST for the detection of magnetism in μ Tesla, demagnetisation and control of magnetic remanence of watches, movements, tools and watch parts.

Functions :

-  - Magnetism detection
-  - Demagnetization
-  - Automatic mode activated
-  - Activate or deactivate the sound
-  - Connected to the power sector 115 - 230 V
-  - Operates on the battery
-  - 1. Compass mode display.
- 2. Calibration of the north of the compass
-  - Return to the main menu
-  - Parameters/settings
-  - Selection between silent or sound mode
-  - Display of the hardware and software version
-  - Resetting the sensors
-  - Activate or deactivate the automatic mode.



Detection sensors : there are 5 sensors and one of them is located in the centre of the detection surface. The others are located in the corners of a 1.5 cm square. They can measure the magnetism force as well as its position. A dot on the LCD screen shows a sensor with its position and the dot size is proportional to the magnetic force.

Demagnetisation.

 Greiner vibrograf



MSA	Voltage	Size	Kg
19.908	DUAL 115 - 230 V	195 x 130 x 140 mm	2.500

The MAGNOMASTER is powerful enough to demagnetise the movement directly inside the case. Demagnetisation is done simultaneously on both sides. Extremely powerful two-coil device. Objects must be rotated by 90° to completely remove the magnetism by pressing the button again. The light of the lamp indicates demagnetisation.

 Greiner vibrograf



MSA	Voltage	Size	Kg
19.901	230 V	230 x 180 x 120 mm	1.170
19.901-110	115 V	230 x 180 x 120 mm	1.170

ANTIMAG AM 2 device for demagnetising watches and small watch parts.

Delivered with operating instructions.

20



Table micromotors NAKANISHI Emax EVOLution



Speed 1'000...40'000 RPM.

MSA	Voltage	Size	Kg
20.362	230 V / 50-60 Hz	130 x 254 x 97 mm	2.300

Table micromotor set NAKANISHI Emax EVOLution improved with the last technologies.

- Digital display on the centre roller
- Variator with speed memory possibility
- Maximum torque 4.3 cN-m
- Start switch can be made on the control unit or directly on the micromotor
- Clockwise and anticlockwise rotation
- A second motor can be connected at the control unit with a A/B selector (cannot be used simultaneously).

Delivered with :

- 1 control unit MSA20.364
- 1 motor MSA20.362-M1
- 1 handpiece MSA20.360-P2
- 1 chuck Ø 2.35 mm MSA20.360-C235
- 1 chuck Ø 3.00 mm MSA20.360-C300
- 1 stand MSA20.360-S
- 1 set of flat and pun wrench keys for locking/unlocking chucks
- 1 power supply cord.



Speed 1'000...25'000 RPM.

MSA	Voltage	Size	Kg
20.365	230 V / 50-60 Hz	130 x 254 x 97 mm	2.300

Table torque micromotor set NAKANISHI Emax EVOLution improved with the last technologies.

- Digital display on the centre roller
- Variator with speed memory possibility
- Maximum torque 4.8 cN-m
- Start switch can be made on the control unit or directly on the micromotor
- Clockwise and anticlockwise rotation
- A second motor can be connected at the control unit with a A/B selector (cannot be used simultaneously).

Delivered with :

- 1 control unit
- 1 motor ENK-250T
- 1 handpiece MSA20.360-P2
- 1 chuck Ø 2.35 mm MSA20.360-C235
- 1 chuck Ø 3.00 mm MSA20.360-C300
- 1 stand MSA20.360-S
- 1 set of flat and pun wrench keys for locking/unlocking chucks
- 1 power supply cord.



MSA	Kg
20.362-F	0.543

ON/OFF foot and speed control pedal for micromotor MSA20.362 and MSA20.365.



Speed 1'000~40'000 RPM.

MSA	Power	Size	Kg
20.362-M1	73 W	Ø 24.50 x 97 mm	0.090

Motor for MSA20.362. Maximum Torque 4.3 cN-m.
Excellent combination of high speed, lightweight, small diameter and high torque.
This lightweight and compact general-use type is perfect for precision work.
Delivered with a 1.5 m power supply cord.



Maximum speed 40'000 RPM.

MSA	Size	Kg
20.360-P1	Ø 14 x 60 mm	0.062

Handpiece with a side lever for fast chuck tightening for micromotor MSA20.362.
Delivered with tightening keys.



Maximum speed 40'000 RPM.

MSA	Size	Kg
20.360-P2	Ø 13 x 64 mm	0.092

Handpiece with a side lever for fast chuck tightening for micromotor MSA20.362.
Delivered with tightening keys.



Optional adaptable chucks for MSA20.360-P1 and MSA20.360-P2 (other diameters available upon request) :

MSA	Item	Kg
20.360-C100	Optional adaptable chuck, length 33.90 mm, Ø 1.00 mm	0.005
20.360-C150	Optional adaptable chuck, length 33.90 mm, Ø 1.50 mm	0.005
20.360-C160	Optional adaptable chuck, length 33.90 mm, Ø 1.60 mm	0.005
20.360-C200	Optional adaptable chuck, length 33.90 mm, Ø 2.00 mm	0.005
20.360-C235	Optional adaptable chuck, length 33.90 mm, Ø 2.00 mm	0.005
20.360-C300	Optional adaptable chuck, length 33.90 mm, Ø 3.00 mm	0.005
20.360-C300	Optional adaptable chuck, length 33.90 mm, Ø 3.00 mm	0.005



Maximum speed 16'000 RPM.

MSA	Size	Kg
20.367	Ø 14 x 93 mm	0.095

Riveting-setting hammer for micromotor MSA20.362.



Maximum speed 35'000 RPM.



MSA	Size	Kg
20.360-P4	Ø 20.20 x 57.30 mm	0.045

Contra-angle handpiece for micromotor MSA20.362. Chuck Ø 3.00 mm included.

Delivered with tightening keys and a set of standard accessories (3 rubber micro-disks and 3 abrasive disks in different diameters).

Optional adaptable chucks (other diameters available upon request) :

MSA	Item	Kg
20.360-160	Optional adaptable chuck, length 17.20 mm, Ø 1.60 mm	0.080
20.360-235	Optional adaptable chuck, length 17.20 mm, Ø 2.35 mm	0.080



Maximum speed 25'000 RPM.

MSA	Size	Kg
20.360-P5	Ø 20 x 105 mm	0.235

Handpiece for micromotor MSA20.362. Reciprocating motion, stroke range 0.8 mm.

Delivered with 1 tightening key, 1 spring holder, 1 ceramic fiber grindstone holder, 1 electroplated diamond file 1.2 x 4 x 50 mm (# 100) and 1 ceramic fiber grindstone 1 x 6 x 50 mm (# 1200).



Belt runs approx. 0~705 metres/minute

MSA	Size	Kg
20.368	200 x 35 x 49 mm	0.576

Belt sander for micromotors.

- Very high belt speed, ideal for applications from deburring to finishing
- Belt runs approx. 0~825 m/minute, circumference 300 mm
- Lightweight, compact, minimal vibration and a small diameter grip design keep the hand free from fatigue for long, continuous operation
- The angle of the belt section is fully adjustable
- Exchanging the belt is simply done by lever release.

Belts included in the delivery (2 pieces of each reference) :

MSA	Item
20.368-4/120	Belt 4 mm, grain 120
20.368-4/240	Belt 4 mm, grain 240
20.368-4/400	Belt 4 mm, grain 400
20.368-6/120	Belt 6 mm, grain 120
20.368-6/240	Belt 6 mm, grain 240
20.368-6/400	Belt 6 mm, grain 400
20.368-8/120	Belt 8 mm, grain 120
20.368-8/240	Belt 8 mm, grain 240
20.368-8/400	Belt 8 mm, grain 400

Accessory belts (other grains are available) :

MSA	Item
20.368-8/600	Belt 8 mm, grain 600
20.368-8/800	Belt 8 mm, grain 800



Table micromotors NAKANISHI Espert 500.



Speed 1'000...50'000 RPM.

MSA	Voltage	Power	Size	Kg
20.361	230 V / 50-60 Hz	200 W	172 x 230 x 94 mm	2.600

The table torque micromotor set NAKANISHI Espert 500 is perfectly adapted for jobs requiring an extra effort.

- Speed regulation on potentiometer or with pedal MSA20.360-F
- Start button on box or directly on the micromotor
- Right/left rotation, tempomat
- A second micromotor can be plugged in with A/B selector (A and B cannot be used simultaneously).

Delivered with :

- 1 control unit MSA20.363
- 1 motor MSA20.361-M1
- 1 handpiece MSA20.361-P1
- 1 chuck Ø 2.35 mm MSA20.360-C235
- 1 chuck Ø 3.00 mm MSA20.360-C300
- 1 stand MSA20.360-S.



MSA	Kg
20.360-F	0.600

Vario pedal for MSA20.361.



Maximum speed : 50'000 RPM.

MSA	Power	Size	Kg
20.361-M1	200 W	Ø 28.30 x 121.40 mm	0.160

Torque motor for MSA20.361. Maximum torque 8.7 cN-m.

Delivered with 1.5 m spiral cord.



Maximum speed : 50'000 RPM.

MSA	Power	Size	Kg
20.361-M2	140 W	Ø 24.50 x 107.80 mm	0.115

Compact motor for MSA20.361. Maximum torque 6.0 cN-m.

Delivered with 1.5 m spiral cord.



MSA	Size	Kg
20.361-P1	Ø 22.40 x 59.40 mm	0.094

Handpiece with rotating quick-clamping system to be fitted on micromotor MSA20.361. Chucks Ø 2.35 and 3.00 mm included.

Delivered with tightening key.

MICROMOTORS

AMANO
MORISHI



MSA	Size	Kg
20.361-P2	Ø 22.40 x 58.90 mm	0.070

Handpiece with rapid tightening ring to be fitted on micromotor MSA20.361. Chucks Ø 2.35 and 3.00 mm included.

Delivered with tightening key.

AMANO
MORISHI



Optional adaptable chucks for MSA20.361-P1 and MSA20.361-P2 (other diameters available upon request) :

MSA	Item	Kg
20.360-C100	Optional adaptable chuck, length 33.90 mm, Ø 1.00 mm	0.005
20.360-C150	Optional adaptable chuck, length 33.90 mm, Ø 1.50 mm	0.005
20.360-C160	Optional adaptable chuck, length 33.90 mm, Ø 1.60 mm	0.005
20.360-C200	Optional adaptable chuck, length 33.90 mm, Ø 2.00 mm	0.005
20.360-C235	Optional adaptable chuck, length 33.90 mm, Ø 2.00 mm	0.005
20.360-C300	Optional adaptable chuck, length 33.90 mm, Ø 3.00 mm	0.005
20.360-C300	Optional adaptable chuck, length 33.90 mm, Ø 3.00 mm	0.005

AMANO
MORISHI



Maximum speed 25'000 RPM.

MSA	Size	Kg
20.361-P3	Ø 15 x 84.50 mm	0.130

Thin pen shape handpiece with rapid tightening ring for small polishing operations, for micromotor MSA20.361.

Delivered with an adapter for economical fibre files.

AMANO
MORISHI



Maximum speed 30'000 RPM.

MSA	Size	Kg
20.361-P5	Ø 22.40 x 64.30 mm	0.054

Contra-angle handpiece for micromotor MSA20.361.

Delivered with tightening keys and a set of standard accessories (3 rubber micro-disks and 3 abrasive disks in different diameters).

Table micromotor ARGOFILE.

MSA	Voltage	Size
20.381	110/220 V	110 x 148 x 96 mm

Table micromotor set MAXIMA PHP 40.
 The compact control unit MSA20.381-02 is a continuously variable speed controller (0...40'000 rpm).
 Handpiece with "One-Touch" quick system.



Speed 0...40'000 RPM.

Delivered with :

- 1 control unit MSA20.381-02
- 1 handpiece MSA20.381-01
- 1 Vario pedal MSA20.381-03
- 1 handpiece stand MSA20.381-04
- 1 pair of carbon brushes MSA20.381-05
- 1 chuck Ø 2.35 mm MSA20.381-235.

Spare parts :

MSA	Item
20.381-01	(1) Handpiece Ø 26 x 145 mm, maximum speed 40'000 RPM
20.381-02	(2) Control unit 110 x 148 x 86 mm, 110/220 V
20.381-03	(3) Vario pedal
20.381-04	(4) Handpiece stand
20.381-05	(5) Pair of carbon brushes

Accessories :

MSA	Item
20.381-235	(6) Chuck for handpiece, Ø 2.35 mm
20.381-300	Chuck for handpiece, Ø 3.00 mm



MSA	Size	Kg
20.381-SB	115 x 65 x 57 mm	0.235

Distributor SPLITTER BOX for micromotors, for use with 2 handpieces.



Working cabinets.



MSA	Size	Kg
23.812	320 x 300 x 250 mm	3.000

Working cabinet for micromotors.
 A removable drawer makes it easy to collect the residues of the precious alloys used.
 The fitting with hose allows the connection of the portable vacuum cleaners MSA23.810 and MSA23.811.
 Excellent working visibility, sealed Plexiglas cabinet.



MSA	Size	Kg
23.813	600 x 400 x 400 mm	15.000

Safety cabinet for finishing work with micromotors.
 This device is equipped with several side entrances on the left and right, a neon light, a fast-air connector and a power supply for the portable vacuum cleaners MSA23.810 and MSA23.811.
 - Bright and wide working area
 - Easy-to-clean heavy-duty grid collector
 - Solid and reliable construction.

See Chapter 23 for other suction systems.

21



SMALL BRUSHES

21 - 2

GRINDING-WHEELS

21 - 6

CIRCULAR-GRAINING STICKS / DIAMOND GRINDING STONE

21 - 10

HAND BRUSHES / BRUSHES

21 - 12

CIRCULAR BRUSHES

21 - 14

SMALL BRUSHES

High quality polishing brushes, shank Ø 2.35 mm.
Maximum speed 15'000 rpm.



21.001 21.002 21.003 21.004 21.005 21.006 21.007 21.008 21.008-17 21.008-19 21.008-A 21.009 21.010

MSA	Type	Material	Ø	Kg
21.001	HP 112	White goat hair	21 mm	0.003
21.002	HP 113	Grey goat hair	21 mm	0.003
21.003	HP 110	White bristle	21 mm	0.003
21.004	HP 111	Black bristle	21 mm	0.003
21.005	HP 115	Brass wire	21 mm	0.005
21.006	HP 116	Steel wire	21 mm	0.004
21.007	HP 100	Chamois	21 mm	0.003

MSA	Type	Material	Ø	Kg
21.008	HP 103	Cotton yarn	24 mm	0.003
21.008-17	HP 103	Cotton yarn	17 mm	0.003
21.008-19	HP 103	Cotton yarn	19 mm	0.003
21.008-A	HP 103	Double cotton yarn	23 mm	0.003
21.009	HP 101	Felt	21 mm	0.003
21.010	HP 102	Flannel	21 mm	0.003



21.011 21.011-17 21.012 21.013 21.014 21.020 21.021 21.022 21.023 21.026 21.027 21.027-A

MSA	Type	Material	Ø	Kg
21.011	HP 102n	Canvas	21 mm	0.003
21.011-17	HP 102n	Canvas	17 mm	0.003
21.012	HP 102n	White stitched canvas	21 mm	0.003
21.013	HP 102n	Unbleached stitched canvas	21 mm	0.003
21.014	HP 110ny	White nylon	23 mm	0.003
21.020	HP 107	White goat hair	-	0.003

MSA	Type	Material	Ø	Kg
21.021	HP 108	Grey goat hair	-	0.003
21.022	HP 105	White bristle	-	0.003
21.023	HP 106	Black bristle	-	0.003
21.026	HP 109	Pony bristle	21 mm	0.003
21.027	HP 114	Grey bristle	21 mm	0.003
21.027-A	HP 114	Grey bristle	23 mm	0.003



(1)

(2)

(3)

MSA	Type	Material	Ø	Kg
21.051-17	(1) MBH 12100	White goat hair	17 mm	0.003
21.051-19	(2) MBH 12200	White goat hair	19 mm	0.003
21.051-23	(3) MBH 12400	White goat hair	23 mm	0.003



ASSORTMENT

MSA	Size	Kg
21.100	145 x 93 x 80 mm	0.287

Assortment of 18 polishing small brushes.
Delivered in 1 plastic box.

Contents :

Rank 1

- MSA21.001 (HP 110) : Ø 21 mm
- MSA21.003 (HP 111) : Ø 21 mm
- MSA21.004 (HP 112) : Ø 21 mm
- MSA21.026 (HP 109) : Ø 21 mm
- MSA21.010 (HP 102) : Ø 21 mm

Rank 2

- MSA21.008 (HP 103) : Ø 21 mm
- MSA21.007 (HP 100) : Ø 21 mm
- MSA21.009 (HP 101) : Ø 21 mm
- MSA21.005 (HP 115) : Ø 21 mm
- MSA21.045 (HP 60) : Ø 21 mm
- MSA21.046 (HP 61) : Ø 21 mm

Rank 3

- MSA21.022 (HP 105) : -
- MSA21.023 (HP 106) : -
- MSA21.031 (HP 104a) : -
- MSA21.041 (HP 56) : Ø 10.30 mm
- MSA21.040 (HP 55) : Ø 10.30 mm
- MSA21.042 (HP 57) : Ø 8.00 mm
- MSA21.043 (HP 58) : Ø 6.50 mm

Spare part :

MSA	Item	Kg
21.100-A	Empty plastic box	0.180



MSA		Type	Grain	Size	Kg
21.418	(1)	A/M	80 - 120 coarse	Ø 30 x 5 mm	0.003
21.416	(2)	A/F	180 - 240 medium	Ø 30 x 5 mm	0.003
21.417	(3)	A/VF	280 - 400 fine	Ø 30 x 5 mm	0.003
21.419	(4)	S/SF	500 extra-fine	Ø 30 x 5 mm	0.003
21.409	(5)	S/VF	800 ultra fine	Ø 30 x 5 mm	0.003

Oxyde aluminium satin finish brush.
For gold, silver, platinum, titanium, acrylic and silicone.



MSA	Type	Ø	Grain	Kg
21.035	103 SBF	25 mm	Fine	0.003
21.036	103 SBM	25 mm	Medium	0.003
21.037	103 SBGG	25 mm	Coarse	0.003

Scotch Brite polishing small brush.



MSA	Material	Size	Kg
21.038	(1) Alcantara hard	Ø 25 x 6	0.003
21.039	(2) Alcantara mini-pli	Ø 22	0.004

Polishing small brush.

SMALL BRUSHES

High quality polishing brushes, shank Ø 2.35 mm.
Maximum speed 11'000 rpm.



MSA	Type	Material	Shape	Kg
21.024	HP 105m	Brass wire	Cup	0.004

Top quality polishing small brush, cup shaped.
Wires length 7 mm.



MSA	Type	Material	Shape	Kg
21.030	HP 104c	White goat hair	Pencil	0.002
21.031	HP 104a	White bristle	Pencil	0.002
21.032	HP 104b	Black bristle	Pencil	0.002
21.033	HP 104m	Brass wire	Pencil	0.003
21.034	HP 104s	Steel wire	Pencil	0.003

Top quality polishing small brush, pencil shaped.
Wires length 10 mm.

High quality felt polishing brushes, shank Ø 2.35 mm.
Maximum speed 5'000 rpm.



21.040 21.041 21.042 21.043 21.043-L 21.045 21.046 21.046-17 21.050

MSA	Type	Shape	Ø	Kg
21.040	HP 55	Flame	10.30 mm	0.002
21.041	HP 56	Round	10.30 mm	0.001
21.042	HP 57	Large point	8.00 mm	0.002
21.043	HP 58	Fine point	6.50 mm	0.003

MSA	Type	Shape	Ø	Kg
21.043-L	HP 58L	Fine and long point	6.50 mm	0.002
21.045	HP 60	Lens	21.00 mm	0.003
21.046	HP 61	Plate	21.00 mm	0.003
21.046-17	HP 61	Plate	17.00 mm	0.003
21.050	9790	Fine point	4.00 mm	0.002



(1)

(2)

(3)

(4)

(5)

MSA	Type	Shape	Size	Kg
21.049-T (1)	HP 59	Thick wheel	Ø 17 x 5 mm	0.003
21.047-D (2)	HP 59	Thin wheel	Ø 21 x 3 mm	0.003
21.047-DE (2)	HP59	Thin wheel	Ø 21 x 3.5 mm	
21.047-T (3)	HP 59	Thin wheel	Ø 21 x 3 mm	0.003
21.048-D (4)	HP 59	Thick wheel	Ø 21 x 5 mm	0.003
21.048-T (5)	HP 59	Thick wheel	Ø 21 x 5 mm	0.003

Hardness : -T = soft ; -D = hard

Polishing felts.



MSA	Type	Shape	Ø	Height	Kg
21.490	50	Cone	10 mm	20 mm	0.001
21.493	50	Cone	15 mm	35 mm	0.003
21.495	50	Cone	20 mm	40 mm	0.004

Top quality polishing felt.



MSA	Type	Shape	Ø	Height	Kg
21.500	52	Lens	30 mm	10 mm	0.003

Top quality polishing felt.



MSA	Material	Ø hole	Size	Kg
21.484	Felt	30 mm	Ø 200 x 15 mm	0.235

Polishing disc, felt hub.



MSA	Type	Shape	Ø	Height	Kg
21.510	51	Wheel	25 mm	4 mm	0.001
21.514	51	Wheel	60 mm	10 mm	0.017

Top quality polishing felt.



MSA	Shape	Ø	Height	Kg
21.507	Wheel	100 mm	20 mm	0.052

Polishing felt for work on gold, silver, brass, bronze and steel.
Hardness half-hard.
Central hole Ø 6 mm.

GRINDING-WHEELS

Rubber polishers for pre-polishing of gold, precious and semi-precious alloys.
Shank Ø 2.35 mm. Maximum speed 20'000 rpm.

1st
STEP



MSA		Ø	Thickness	Kg
21.600	(1)	6.0 mm	10.0 mm	0.001
21.601	(2)	3.0 mm	6.0 mm	0.001
21.602	(3)	5.5 mm	15.5 mm	0.001
21.603	(4)	5.5 mm	16.3 mm	0.001
21.604	(5)	5.0 mm	16.0 mm	0.001
21.606	(6)	15.0 mm	2.5 mm	0.001
21.607	(7)	22.0 mm	0.6 mm	0.001
21.609	(8)	14.5 mm	2.0 mm	0.001

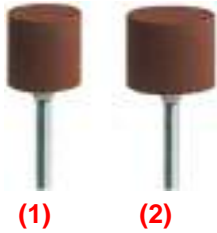

MSA		Ø	Thickness	Kg
21.610	(1)	12 mm	12 mm	0.001
21.611	(2)	14 mm	12 mm	0.001

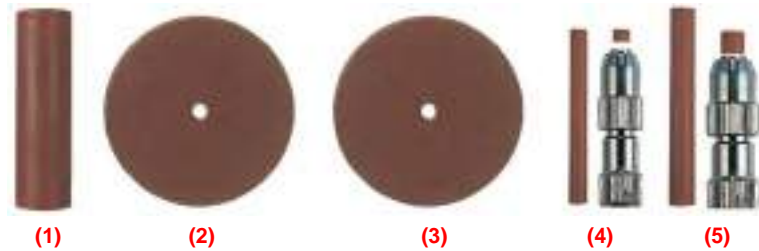

MSA		Ø	Thickness	Kg
21.612	(1)	6 mm	22 mm	0.001
21.613	(2)	22 mm	1 mm	0.001
21.614	(3)	22 mm	3 mm	0.001
21.615	(4)*	2 mm	20 mm	0.001
21.616	(5)*	3 mm	22 mm	0.001

* Reference delivered without holder

Rubber polishers for high-gloss polishing of gold, precious and semi-precious alloys.
Shank Ø 2.35 mm. Maximum speed 10'000 rpm.

2nd
STEP



MSA		Ø	Thickness	Kg
21.617	(1)	6.0 mm	10.0 mm	0.001
21.618	(2)	3.0 mm	6.0 mm	0.001
21.619	(3)	5.5 mm	15.5 mm	0.001
21.620	(4)	5.5 mm	16.3 mm	0.001
21.621	(5)	5.0 mm	16.0 mm	0.001
21.623	(6)	15.0 mm	2.5 mm	0.001
21.624	(7)	22.0 mm	0.6 mm	0.001
21.626	(8)	14.5 mm	2.0 mm	0.001



MSA		Ø	Thickness	Kg
21.627	(1)	12 mm	12 mm	0.001
21.628	(2)	14 mm	12 mm	0.001

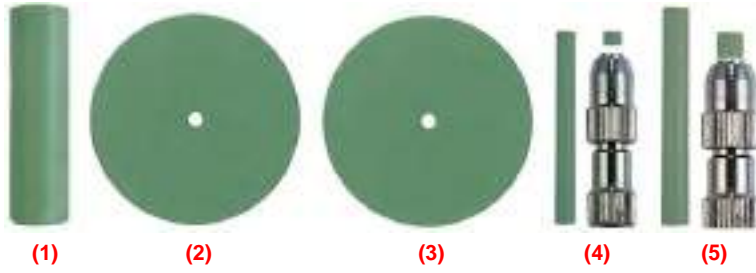

MSA		Ø	Thickness	Kg
21.629	(1)	6 mm	22 mm	0.001
21.630	(2)	22 mm	1 mm	0.001
21.631	(3)	22 mm	3 mm	0.001
21.632	(4)*	2 mm	20 mm	0.001
21.633	(5)*	3 mm	22 mm	0.001

* Reference delivered without holder

Rubber polishers for high-gloss polishing of gold, precious and semi-precious alloys.
Shank Ø 2.35 mm. Maximum speed 10'000 rpm.

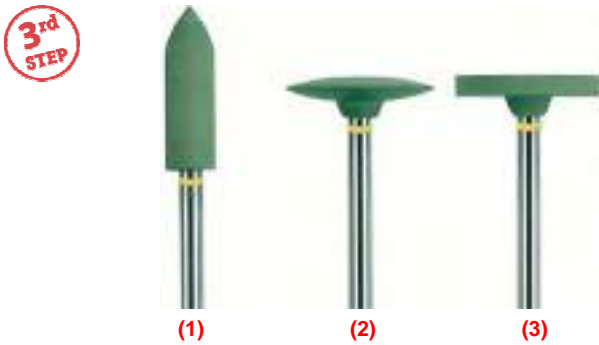

MSA		Ø	Thickness	Kg
21.634	(1)	5.0 mm	16.0 mm	0.001
21.635	(2)	15.0 mm	2.5 mm	0.001
21.636	(3)	14.5 mm	2.0 mm	0.001

Silicon black universal polishers, suitable for precious metals and all alloys, chrome-cobalt and titanium.
Speed 20'000 rpm.

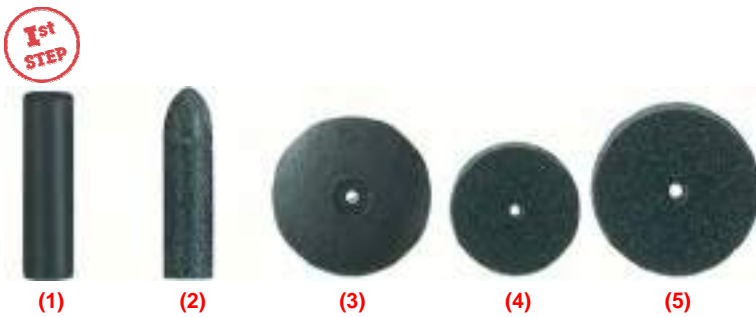

MSA		Ø	Thickness	Kg
21.637	(1)	7 mm	21 mm	0.001
21.638	(2)	6 mm	23 mm	0.001
21.639	(3)	22 mm	3 mm	0.001
21.640	(4)	17 mm	3 mm	0.001
21.641	(5)	22 mm	3 mm	0.001

Silicon black universal polishers, suitable for precious metals and all alloys, chrome-cobalt and titanium.
Speed 10'000 rpm.



MSA		Ø	Thickness	Kg
21.642	(1)	5.5 mm	16.3 mm	0.001
21.644	(2)	15.0 mm	2.5 mm	0.001
21.645	(3)	17.0 mm	3.0 mm	0.001
21.646	(4)	22.0 mm	3.0 mm	0.001

GRINDING-WHEELS

Silicon polisher suitable for precious metals, chrome-cobalt and titanium.
Maximum speed 20'000 rpm.



MSA	Ø	Thickness	Kg
21.599	22 mm	3 mm	0.001

Diamond polishing wheels suitable for titanium and platinum.
Maximum speed 5'000 rpm.

1st
STEP



(1)

2nd
STEP



(2)

MSA	Ø	Thickness	Kg	
21.801	(1)	25 mm	2 mm	0.022
21.802	(2)	25 mm	2 mm	0.022

Flexible polishers for removing scratches and smoothing the chrome-cobalt surfaces.
Maximum speed 20'000 rpm.

1st
STEP



(1)



(2)



(3)



(4)



(5)

MSA	Ø	Thickness	Kg	
21.647	(1)*	2 mm	20 mm	0.001
21.648	(2)*	3 mm	22 mm	0.001
21.649	(3)	6 mm	22 mm	0.001
21.650	(4)	22 mm	1 mm	0.001
21.651	(5)	22 mm	3 mm	0.001

* Reference delivered without holder

Flexible polishers suitable for glazing precious stones and platinum.
Shank Ø 2.35 mm. Maximum speed 10'000 rpm.

2nd
STEP



(1)



(2)

MSA	Ø	Thickness	Kg	
21.670	(1)	5 mm	16 mm	0.001
21.750	(2)	22 mm	3 mm	0.001

Flexible polishers for gem stones and platinum ; provides a lustre high-gloss finishing.
Shank Ø 2.35 mm. Maximum speed 5'000 rpm.

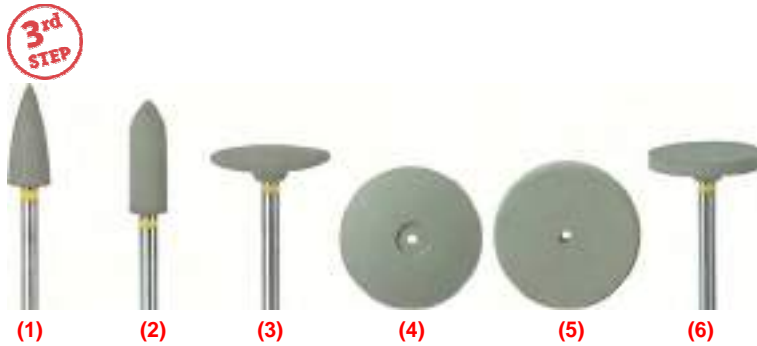

MSA		Ø	Thickness	Kg
21.652	(1)	5.5 mm	15.5 mm	0.001
21.653	(2)	5.0 mm	16.0 mm	0.001
21.654	(3)	15.0 mm	2.5 mm	0.001
21.655	(4)	22.0 mm	3.0 mm	0.001
21.656	(5)	22.0 mm	3.0 mm	0.001
21.657	(6)	14.5 mm	2.0 mm	0.001

Separating discs of synthetic resin with extra fine grain.
Speed 15'000-20'000 rpm.

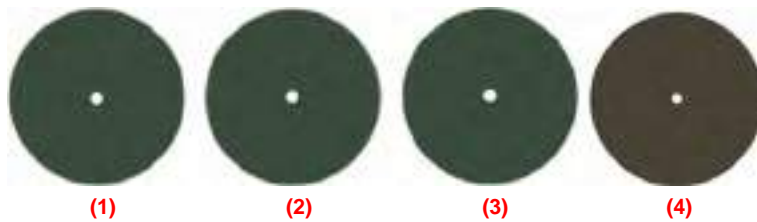

MSA		Ø	Thickness	Kg
21.667	(1)	22 mm	0.20 mm	0.001
21.668	(2)	22 mm	0.25 mm	0.001
21.669	(3)	22 mm	0.30 mm	0.001
21.671	(4)	25 mm	0.60 mm	0.001

Abrasive diamond polisher suitable for precise machining of precious materials.
Maximum speed 15'000 - 20'000 rpm.



MSA		Ø	Thickness	Kg
21.800		22 mm	1.5 mm	0.022

Stainless steel holders for polishers and discs.



MSA		Ø	Length	Kg
21.659	(1)	2 mm	22 mm	0.001
21.660	(2)	3 mm	22 mm	0.001



MSA		Ø	Length	Kg
21.661	(1)	5 mm	3 mm	0.001
21.662	(2)	5 mm	13 mm	0.001
21.663	(3)	5 mm	3 mm	0.001
21.664	(4)	14 mm	3 mm	0.001
21.665	(5)	8 mm	3 mm	0.001
21.677		2.34 mm	44 mm	0.001

CIRCULAR-GRAINING STICKS / DIAMOND GRINDING STONE

HOLDERS FOR CIRCULAR-GRAINING STICKS.

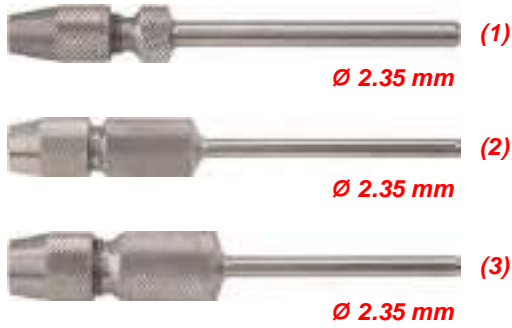

MSA	Use with	Kg
21.700	(1) Sticks \varnothing 1.5 MSA21.700-1x	0.006
21.701	Sticks \varnothing 2.0 MSA21.701-2x	0.006
21.702	Sticks \varnothing 2.5 MSA21.702-2.5x	0.006
21.703	(2) Sticks \varnothing 3.0 MSA21.703-3x	0.006
21.704	Sticks \varnothing 4.0 MSA21.704-4x	0.006
21.705	(3) Sticks \varnothing 5.0 MSA21.705-5x	0.006
21.706	Sticks \varnothing 6.0 MSA21.706-6x	0.006

Holder for circular-graining sticks.

Circular-graining sticks.



MSA		\varnothing	Grain	Length	Kg
21.700-1A		1.5 mm	X-coarse	15 mm	0.001
21.700-1B		1.5 mm	Coarse	15 mm	0.001
21.700-1C		1.5 mm	Medium	15 mm	0.001
21.700-1D		1.5 mm	Fine	15 mm	0.001
21.700-1E		1.5 mm	X-fine	15 mm	0.001

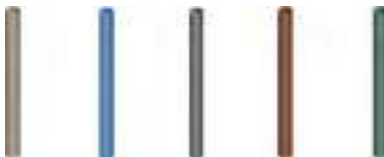

MSA		\varnothing	Grain	Length	Kg
21.701-2A		2 mm	X-coarse	20 mm	0.001
21.701-2B		2 mm	Coarse	20 mm	0.001
21.701-2C		2 mm	Medium	20 mm	0.001
21.701-2D		2 mm	Fine	20 mm	0.001
21.701-2E		2 mm	X-fine	20 mm	0.001



MSA		\varnothing	Grain	Length	Kg
21.703-3A		3 mm	X-coarse	23 mm	0.001
21.703-3B		3 mm	Coarse	23 mm	0.001
21.703-3C		3 mm	Medium	23 mm	0.001
21.703-3D		3 mm	Fine	23 mm	0.001
21.703-3E		3 mm	X-fine	23 mm	0.001

CIRCULAR-GRAINING STICKS / DIAMOND GRINDING STONE

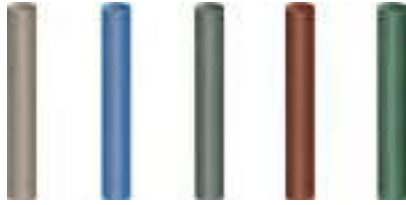

MSA		Ø	Grain	Length	Kg
21.704-4A		4 mm	X-coarse	26 mm	0.001
21.704-4B		4 mm	Coarse	26 mm	0.001
21.704-4C		4 mm	Medium	26 mm	0.001
21.704-4D		4 mm	Fine	26 mm	0.001
21.704-4E		4 mm	X-fine	26 mm	0.001

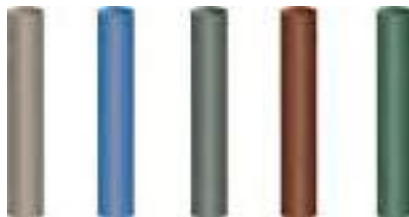

MSA		Ø	Grain	Length	Kg
21.705-5A		5 mm	X-coarse	28 mm	0.001
21.705-5B		5 mm	Coarse	28 mm	0.001
21.705-5C		5 mm	Medium	28 mm	0.001
21.705-5D		5 mm	Fine	28 mm	0.001
21.705-5E		5 mm	X-fine	28 mm	0.001



MSA		Ø	Grain	Length	Kg
21.706-6A		6 mm	X-coarse	22 mm	0.001
21.706-6B		6 mm	Coarse	22 mm	0.001
21.706-6C		6 mm	Medium	22 mm	0.001
21.706-6D		6 mm	Fine	22 mm	0.001
21.706-6E		6 mm	X-fine	22 mm	0.001

Diamond grinding stone.



MSA	Length	Kg
21.666	116 mm	0.053

Diamond grinding stone for dressing, shaping and restoring of deformed silicon and stones polishers ; all sides coated.

Polishing hand brushes.



MSA	Material	Hardness	Rows	Size	Kg
21.200	Black bristle	Medium	3	225 x 16 x 10 mm	0.027
21.201	(1) Black bristle	Hard	4	260 x 16 x 8 mm	0.035

Hand brush with wooden handle.



MSA	Material	Hardness	Rows	Size	Kg
21.210	(1) White bristle	N° 0 very hard	4	260 x 16 x 8 mm	0.033
21.211	White bristle	N° 1 hard	4	260 x 16 x 8 mm	0.032
21.215	White bristle	N° 2 medium	4	260 x 16 x 8 mm	0.034
21.212	White bristle	N° 3 soft	4	260 x 16 x 8 mm	0.036
21.213	White bristle	N° 4 extra-soft	4	260 x 16 x 8 mm	0.035

Hand brush with wooden handle.



MSA	Material	Rows	Size	Kg
21.216	Nylon® wire Ø 0.20 mm	4	260 x 16 x 8 mm	0.034

Hand brush with wooden handle.



MSA	Material	Rows	Size	Kg
21.251	(1) Brass wire Ø 0.10 mm	4	220 x 18 x 9 mm	0.038
21.252	Steel wire Ø 0.10 mm	4	220 x 18 x 9 mm	0.045

Hand brush with wooden handle.



MSA	Material	Size	Kg
21.260	Steel wire	240 x 28 x 20 mm	0.054

Brush for files cleaning with wooden handle.

Brushes.



MSA	Size	Kg
26.158	45 x 45 x 45 mm	0.015

Benzine brush with aluminium handle. White bristle.



MSA	Size	Kg
26.190	215 x 30 mm	0.020
26.159	215 x 40 mm	0.026
26.191	215 x 60 mm	0.035

Flat brush with wooden handle.



MSA	Size	Kg
26.163	100 x 30 mm	0.015

Flat brush with wooden handle. White bristle.



MSA	Size	Kg
26.162	Ø 10 x 100 mm	0.005

Extra soft double bristle brush, ideal for cleaning dials. Small grey hair.



MSA	Size	Kg
26.164	Ø 6 x 125 mm	0.003

Stencil brush.

CIRCULAR BRUSHES

Circular polishing brushes.



MSA	Type	Material	Ø ext.	Kg
21.310	(1) 32P/90	Goat hair	90 mm	0.040
21.340	(2) 2/70P	Cotton	70 mm	0.043
21.341	3/80P	Cotton	80 mm	0.068
21.342	4/90P	Cotton	90 mm	0.070

MSA	Type	Material	Ø ext.	Kg
21.343	5/100P	Cotton	100 mm	0.090
21.350	(3) 20/80	Cotton yarn	80 mm	0.038
21.351	20/90	Cotton yarn	90 mm	0.035

Top quality circular polishing brush, with plastic hub.



MSA	Type	Material	Ø ext.	Rows	Kg
21.330	3/40/80	White bristle	80 mm	3	0.030
21.331	4/40/80	White bristle	80 mm	4	0.034

PRIMA top quality very hard circular polishing brush, wooden hub. Converging rows.



MSA	Type	Material	Ø ext.	Rows	Kg
21.320	3/40/80	Black bristle	80 mm	3	0.032
21.322	5/45/90	Black bristle	90 mm	5	0.036

SUPREMA top quality extra-hard circular polishing brush, wooden hub. Converging rows.



MSA	Type	Material	Ø ext.	Ø wire	Kg
21.370	(1) 22P/08/090	Brass wire	90 mm	0.08 mm	0.136
21.380	(2) 25P/08/090	Steel wire	90 mm	0.08 mm	0.090

Top quality circular polishing brush, plastic hub.





MSA	Type	Material	Ø ext.	Ø wire	Kg
21.380-B (1)	25/08/090	Steel wire	90 mm	0.08 mm	0.090
21.382-B	25/10/100	Steel wire	100 mm	0.10 mm	0.090

Top quality circular polishing brush, wooden hub.



MSA	Type	Material	Ø ext.	Rows	Kg
21.319	Chung-King	Black bristle	80 mm	4	0.040

Top quality hard circular polishing brush, wooden hub. Converging rows.

Satin finish brushes.



MSA	Type	Material	Grain	Size	Kg
21.413	(1)	FB6	Medium	Ø 100 x 25 mm	0.100
21.414	(2)	FB6	Fine	Ø 100 x 25 mm	0.100
21.415	(3)	FB6	Extra-fine	Ø 100 x 25 mm	0.100

BUFFLEX® FB6 satin finish brush.

Used without compound.

Fast and easy to clean with water or air pressure. Regular erosion. Central hole Ø 6 mm.



Soft grinding-wheels.



MSA	Type	Grain	Size	Use with	Kg
21.070	SC46MP	Very coarse (medium)	Ø 100 x 20 mm	Pre-satin finish	0.180
21.071	SC46WP	Very coarse (soft)	Ø 100 x 20 mm	Pre-satin finish	0.180
21.077	SC80MP	Coarse (medium)	Ø 100 x 20 mm	Pre-satin finish	0.180
21.078	SC80WP	Coarse (soft)	Ø 100 x 20 mm	Pre-satin finish	0.180
21.075	SC80VAP	Coarse (very soft)	Ø 100 x 20 mm	Pre-satin finish	0.180
21.073	SC150WP	Medium (soft)	Ø 100 x 20 mm	Satin-finish	0.178
21.074	SC250MP	Fine (medium)	Ø 100 x 20 mm	Fine satin-finish	0.170

ARTIFEX soft silicon carbide grinding-wheel to polish or satin all sorts of metal.

Delivered with a removable hole diameter reducer Ø 6 mm.

CIRCULAR BRUSHES



MSA	Kg
21.090	0.196

True tool for silicon carbide grinding-wheels.

Flap wheels.



MSA	Type	Grain	Size	Kg
21.052-120	0839.9170	120	Ø 80 x 30 mm	0.122
21.052-180	0028.9170	180	Ø 80 x 30 mm	0.119

SIAMOP flap wheel on shank Ø 6 mm.

Polishing discs.

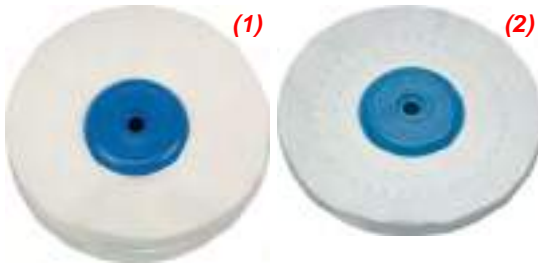

MSA	Type	Material	Size	Kg
21.420 (1)	29P/100/9	Canvas	Ø 100 x 9 mm	0.052
21.421	29P/100/12	Canvas	Ø 100 x 12 mm	0.064
21.430 (2)	29c/100/6	Stitched canvas	Ø 100 x 6 mm	0.040

Top quality polishing disc, plastic hub.



MSA	Type	Material	Size	Kg
21.422 (1)	29/100/18	Canvas	Ø 100 x 18 mm	0.092
21.423	29/100/24	Canvas	Ø 100 x 24 mm	0.133
21.424	29/125/30	Canvas	Ø 125 x 30 mm	0.230
21.450 (2)	30/100/6	Flannel	Ø 100 x 6 mm	0.025
21.452	30/100/12	Flannel	Ø 100 x 12 mm	0.035

Top quality polishing disc, leather hub.



MSA	Type	Material	Ø	Ø hole	Kg
21.427	W 30	Coton canvas	100 mm	6 mm	0.098

BUFFLEX polishing disc with 60 agraphed sheets on carton hub.



MSA	Type	Material	Ø ext.	Ply	Kg
21.480	27/4/90	Felt	90 mm	4	0.026
21.481	27/4/100	Felt	100 mm	4	0.027
21.483	27/6/100	Felt	100 mm	6	0.040

Top quality polishing disc, plastic hub.

Polishing comb.



MSA	Kg
21.485	0.475

Polishing comb.

This comb is indispensable for cleaning and sizing the polishing cloth. It eliminates the hardness resulting from the polishing compound build and gives an extended life to the wheels.

Size without handles : 130 x 90 x 3 mm.

22

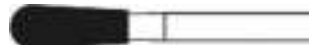

HOROTEC® END MILLS

22 - 2

HOROTEC® REAMERS

22 - 7

END MILLS

22 - 9

DIAMOND BURS

22 - 19

DRILLS

22 - 35

Hard metal end mills.



ASSORTMENT

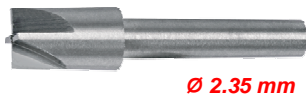

MSA	Size	Kg
22.566	125 x 81 x 50 mm	0.260

Assortment of 12 hard metal end mills and 11 steel pivots. The pivots work as a guide in the hole and the end mills trim the desired part. The pivots are interchangeable with every end mill. It can be used by hand or on a press. *Delivered in a wooden box.*

* Items in the assortment MSA22.566

Spare end mills :

MSA	Item	Kg
22.566-F100	End mill, Ø 1.00 x L20 mm, angle 2°	0.001
22.566-F120 *	End mill, Ø 1.20 x L20 mm, angle 2°	0.001
22.566-F150 *	End mill, Ø 1.50 x L20 mm, angle 2°	0.001
22.566-F175 *	End mill, Ø 1.75 x L20 mm, angle 2°	0.001
22.566-F180	End mill, Ø 1.80 x L20 mm, angle 2°	0.001
22.566-F200 *	End mill, Ø 2.00 x L20 mm, angle 2°	0.001
22.566-F225 *	End mill, Ø 2.25 x L20 mm, angle 2°	0.001
22.566-F250 *	End mill, Ø 2.50 x L20 mm, angle 2°	0.001
22.566-F275 *	End mill, Ø 2.75 x L20 mm, angle 2°	0.001
22.566-F300 *	End mill, Ø 3.00 x L20 mm, angle 2°	0.001
22.566-F325 *	End mill, Ø 3.25 x L20 mm, angle 2°	0.002
22.566-F350 *	End mill, Ø 3.50 x L20 mm, angle 2°	0.002
22.566-F375 *	End mill, Ø 3.75 x L20 mm, angle 2°	0.002
22.566-F400 *	End mill, Ø 4.00 x L20 mm, angle 2°	0.002

Spare pivots :

MSA	Item	Kg
22.566-P040	Pivot, Ø 0.40 (a) x L24.50 mm	0.001
22.566-P050 *	Pivot, Ø 0.50 (a) x L24.50 mm	0.001
22.566-P060 *	Pivot, Ø 0.60 (a) x L24.50 mm	0.001
22.566-P070 *	Pivot, Ø 0.70 (a) x L24.50 mm	0.001
22.566-P080 *	Pivot, Ø 0.80 (a) x L24.50 mm	0.001
22.566-P090 *	Pivot, Ø 0.90 (a) x L24.50 mm	0.001
22.566-P100 *	Pivot, Ø 1.00 (a) x L24.50 mm	0.001
22.566-P110 *	Pivot, Ø 1.10 (a) x L24.50 mm	0.001
22.566-P120 *	Pivot, Ø 1.20 (a) x L24.50 mm	0.001
22.566-P130 *	Pivot, Ø 1.30 (a) x L24.50 mm	0.001
22.566-P140 *	Pivot, Ø 1.40 (a) x L24.50 mm	0.001
22.566-P150 *	Pivot, Ø 1.50 (a) x L24.50 mm	0.001

Spare tool holder :

MSA	Item	Kg
22.568 *	Pivot, Ø 4.70 x L90 mm	0.011

Hard metal screw shoulder end mills with 5 cutters.



ASSORTMENT

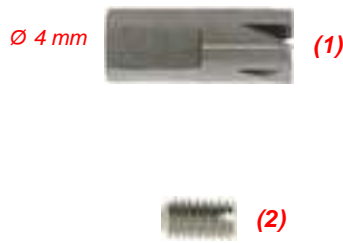

MSA	Size	Kg
22.590	80 x 35 x 10 mm	0.060

Assortment of 16 hard metal screw shoulder end mills with 5 cutters, allowing the adjustment of the shoulder height of chronographer screws. Each end mill is easily replaceable thanks to a side screw holding it.

* Items in the assortment MSA22.590

Spare parts :

MSA	Item	Kg
22.590-030	(1) End mill Ø 0.30 mm	0.002
22.590-035	End mill Ø 0.35 mm	0.002
22.590-040	End mill Ø 0.40 mm	0.002
22.590-045	End mill Ø 0.45 mm	0.002
22.590-050 *	End mill Ø 0.50 mm	0.002
22.590-055 *	End mill Ø 0.55 mm	0.002
22.590-060 *	End mill Ø 0.60 mm	0.002
22.590-065 *	End mill Ø 0.65 mm	0.002
22.590-070 *	End mill Ø 0.70 mm	0.002
22.590-075 *	End mill Ø 0.75 mm	0.002
22.590-080 *	End mill Ø 0.80 mm	0.002
22.590-085 *	End mill Ø 0.85 mm	0.002
22.590-090 *	End mill Ø 0.90 mm	0.002
22.590-095 *	End mill Ø 0.95 mm	0.002
22.590-100 *	End mill Ø 1.00 mm	0.002
22.590-105	End mill Ø 1.05 mm	0.002
22.590-110 *	End mill Ø 1.10 mm	0.002
22.590-115	End mill Ø 1.15 mm	0.002
22.590-120 *	End mill Ø 1.20 mm	0.002
22.590-125	End mill Ø 1.25 mm	0.002
22.590-130 *	End mill Ø 1.30 mm	0.002
22.590-140 *	End mill Ø 1.40 mm	0.002
22.590-150 *	End mill Ø 1.50 mm	0.002
22.590-160	End mill Ø 1.60 mm	0.002
22.590-170	End mill Ø 1.70 mm	0.002
22.590-180	End mill Ø 1.80 mm	0.002
22.590-190	End mill Ø 1.90 mm	0.002
22.590-A	Plate	0.036
22.590-C	(2) Side screw	0.001

Double ended wheel countersinks.



ASSORTMENT

MSA	Kg
22.560	0.030

Assortment of 4 hardened steel double ended wheel countersinks. Wheels diameter : 1.80-2.10 / 2.50-3.00 / 3.50-4.00 / 4.50-5.00 mm. Delivered in a plastic pouch.

Spare parts :

MSA	Item	Kg
22.560-01	Double ended wheel countersink, Ø 1.80-2.10 mm	0.010
22.560-02	Double ended wheel countersink, Ø 2.50-3.00 mm	0.010
22.560-03	Double ended wheel countersink, Ø 3.50-4.00 mm	0.010
22.560-04	Double ended wheel countersink, Ø 4.50-5.00 mm	0.010

Wheel countersinks.



ASSORTMENT

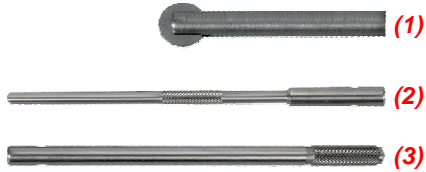

MSA	Size	Kg
22.559	125 x 81 x 50 mm	0.265

Assortment of 14 wheel countersinks specially conceived to release the mouldings (collets, screw openings, etc.), mounted on a conical handle.

Delivered in a wooden box with :

- 2 tool holders MSA22.564-030 and MSA22.564-047 (for use by hand or on a press)
- 14 wheel countersinks (2 of each diameter)

Spare parts :

MSA	Item	Kg
22.562-150	(1) HM wheel countersinks Ø 1.50 mm, length 25 mm, angle 1°	0.001
22.562-200	HM wheel countersinks Ø 2.00 mm, length 25 mm, angle 1°	0.001
22.562-250	HM wheel countersinks Ø 2.50 mm, length 25 mm, angle 1°	0.001
22.562-300	HM wheel countersinks Ø 3.00 mm, length 25 mm, angle 1°	0.001
22.562-350	HM wheel countersinks Ø 3.50 mm, length 25 mm, angle 1°	0.001
22.562-400	HM wheel countersinks Ø 4.00 mm, length 25 mm, angle 1°	0.001
22.562-450	HM wheel countersinks Ø 4.50 mm, length 25 mm, angle 1°	0.001
22.564-030	(2) Tools holder Ø 3.00 mm, length 100 mm Manual use	0.008
22.564-047	(3) Tools holder Ø 4.70 mm, length 90 mm Use on a press	0.012



ASSORTMENT

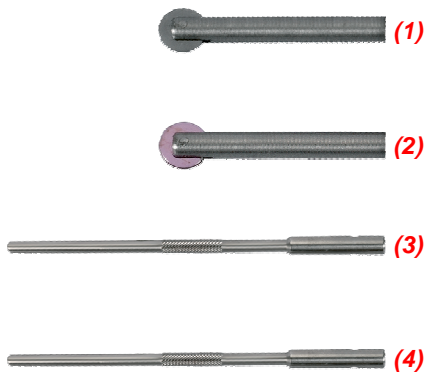

MSA	Size	Kg
22.565	125 x 81 x 50 mm	0.290

Assortment of 14 wheel countersinks containing :
 - 7 hard metal wheel countersinks, specially conceived to release the mouldings (collets, screw openings, etc.), mounted on a conical handle
 - 7 ruby wheel countersinks for polishing mouldings, mounted on a conical handle. It can be used with or without lubricants. Using the ruby wheel countersinks guarantees a smothering surface than ever.
 Both countersinks must be used successively (1st : tungsten carbide / 2nd : ruby) to obtain a perfect polish.
Delivered in a wooden box with 2 tool holders MSA22.564-030 and MSA22.564-047 (for use by hand or on a press).

Spare parts :

MSA	Item	Kg
22.562-150	(1) HM wheel countersinks Ø 1.50 mm, length 25 mm, angle 1°	0.001
22.562-200	HM wheel countersinks Ø 2.00 mm, length 25 mm, angle 1°	0.001
22.562-250	HM wheel countersinks Ø 2.50 mm, length 25 mm, angle 1°	0.001
22.562-300	HM wheel countersinks Ø 3.00 mm, length 25 mm, angle 1°	0.001
22.562-350	HM wheel countersinks Ø 3.50 mm, length 25 mm, angle 1°	0.001
22.562-400	HM wheel countersinks Ø 4.00 mm, length 25 mm, angle 1°	0.001
22.562-450	HM wheel countersinks Ø 4.50 mm, length 25 mm, angle 1°	0.001
22.563-150	(2) Ruby wheel countersinks Ø 1.50 mm, length 25 mm, angle 1°	0.001
22.563-200	Ruby wheel countersinks Ø 2.00 mm, length 25 mm, angle 1°	0.001
22.563-250	Ruby wheel countersinks Ø 2.50 mm, length 25 mm, angle 1°	0.001
22.563-300	Ruby wheel countersinks Ø 3.00 mm, length 25 mm, angle 1°	0.001
22.563-350	Ruby wheel countersinks Ø 3.50 mm, length 25 mm, angle 1°	0.001
22.563-400	Ruby wheel countersinks Ø 4.00 mm, length 25 mm, angle 1°	0.001
22.563-450	Ruby wheel countersinks Ø 4.50 mm, length 25 mm, angle 1°	0.001
22.564-030	(3) Tools holder Ø 3.00 mm, length 100 mmm Manual use	0.008
22.564-047	(4) Tools holder Ø 4.70 mm, length 90 mmm Use on a press	0.012

End mills for removing burrs and bevelling.



ASSORTMENT

MSA	Size	Kg
22.577	130 x 105 x 25 mm	0.123

Assortment of 12 hard metal end mills for removing burrs and bevelling. Delivered with an aluminium handle in a plastic box.



Spare parts :

MSA	Item	Kg
22.577-11	End mill for deburring screws ends, Ø 0.90 mm	0.002
22.577-12	End mill for deburring screws ends, Ø 1.30 mm	0.002
22.577-05	(1) End mill for deburring screws ends, Ø 2.50 mm	0.002
22.577-07	End mill for deburring screws ends (4 teeth), Ø 3 mm	0.002
22.577-06	End mill for deburring screws ends, Ø 4 mm	0.003
22.577-08	End mill for deburring screws ends (4 teeth), Ø 4 mm	0.003
-	-	-
22.577-09	End mill for bevelling, Ø 1.00 mm	0.001
22.577-10	(2) End mill for bevelling, Ø 2.00 mm	0.001
22.577-03	End mill for bevelling, Ø 3.00 mm	0.002
22.577-04	End mill for bevelling, Ø 4.00 mm	0.002
-	-	-
22.577-01	(3) Conical end mill, Ø 3.00 mm	0.002
22.577-02	Conical end mill, Ø 4.50 mm	0.003
-	-	-
22.577-A	(4) Handle	0.011



ASSORTMENT

MSA	Size	Kg
22.578	122 x 70 x 30 mm	0.126

Assortment of 6 hard metal double end mills for removing burrs and bevelling (Hardness Rochwell 62-64).

Delivered with an aluminium anodised red handle in a wooden box.



Spare parts :

MSA	Item	Kg
22.578-01	(1) Conical double end mill, Ø 3.00-4.50 mm	0.007
22.578-02	(2) Double end mill for bevelling, Ø 3.00-4.00 mm	0.006
22.578-05	Double end mill for bevelling, Ø 1.00-2.00 mm	0.002
22.578-03	(3) Double end mill for deburring screws ends, Ø 2.50-4.00 mm	0.006
22.578-06	Double end mill for deburring screws ends, Ø 0.90-1.30 mm	0.002
22.578-04	(4) End mill for deburring with 4 teeth, Ø 3.00-4.00 mm	0.007

Cone shape hard metal reamers.



ASSORTMENT

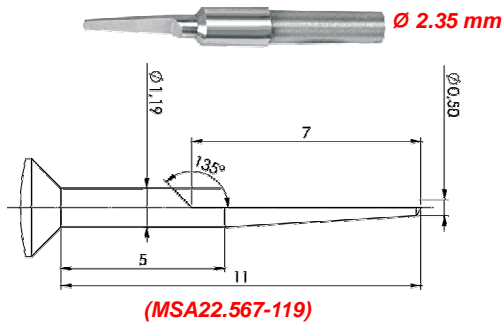

MSA	Size	Kg
22.567	125 x 81 x 50 mm	0.250

Assortment of 12 cone shaped hard metal reamers for the drilling finishing (example : hand hole).
Suggested use with a press.
Delivered in a wooden box.

* Items in the assortment MSA22.567

Spare reamers :

MSA	Item	Kg
22.567-053	Reamer no. 53, Ø 0.53 x L 25 mm, angle 2°	0.001
22.567-054	Reamer no. 54, Ø 0.54 x L 25 mm, angle 2°	0.001
22.567-055	Reamer no. 55, Ø 0.55 x L 25 mm, angle 2°	0.001
22.567-069 *	Reamer no. 69, Ø 0.69 x L 25 mm, angle 2°	0.001
22.567-079 *	Reamer no. 79, Ø 0.79 x L 25 mm, angle 2°	0.001
22.567-089 *	Reamer no. 89, Ø 0.89 x L 25 mm, angle 2°	0.001
22.567-099 *	Reamer no. 99, Ø 0.99 x L 25 mm, angle 2°	0.001
22.567-109 *	Reamer no. 109, Ø 1.09 x L 25 mm, angle 2°	0.001
22.567-119 *	Reamer no. 119, Ø 1.19 x L 25 mm, angle 2°	0.001
22.567-129 *	Reamer no. 129, Ø 1.29 x L 25 mm, angle 2°	0.001
22.567-139 *	Reamer no. 139, Ø 1.39 x L 25 mm, angle 2°	0.001
22.567-149 *	Reamer no. 149, Ø 1.49 x L 25 mm, angle 2°	0.001
22.567-159 *	Reamer no. 159, Ø 1.59 x L 25 mm, angle 2°	0.001
22.567-169 *	Reamer no. 169, Ø 1.69 x L 25 mm, angle 2°	0.001
22.567-179 *	Reamer no. 179, Ø 1.79 x L 25 mm, angle 2°	0.001

Spare tool holder :

MSA	Item	Kg
22.568 *	Pivot, Ø 4.70 x L90 mm	0.011



ASSORTMENT

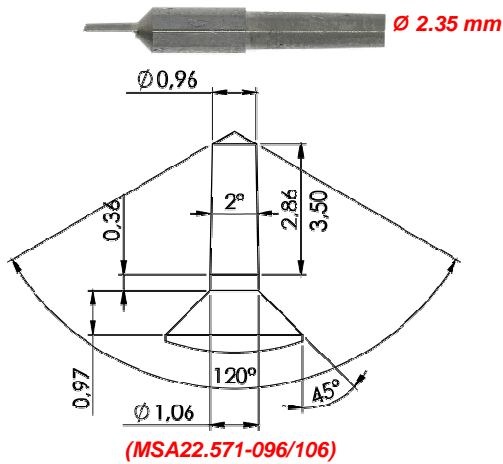

MSA	Size	Kg
22.571	145 x 75 x 40 mm	0.250

Assortment of 12 cone shaped hard metal reamers for the drilling finishing (example : hand hole).
Suggested use with a press.
Delivered in a wooden box.

* Items in the assortment MSA22.571

Spare reamers :

MSA	Item	Kg
22.571-032/042	Reamer $\text{Ø } 0.32\text{...}0.42 \times \text{L}19.50 \text{ mm}$, angle 2°	0.001
22.571-040/050	Reamer $\text{Ø } 0.40\text{...}0.50 \times \text{L}19.50 \text{ mm}$, angle 2°	0.001
22.571-048/058	Reamer $\text{Ø } 0.48\text{...}0.58 \times \text{L}19.50 \text{ mm}$, angle 2°	0.001
22.571-056/066	Reamer $\text{Ø } 0.56\text{...}0.66 \times \text{L}19.50 \text{ mm}$, angle 2°	0.001
22.571-064/074	Reamer $\text{Ø } 0.64\text{...}0.74 \times \text{L}19.50 \text{ mm}$, angle 2°	0.001
22.571-072/082	Reamer $\text{Ø } 0.72\text{...}0.82 \times \text{L}19.50 \text{ mm}$, angle 2°	0.001
22.571-080/090	Reamer $\text{Ø } 0.80\text{...}0.90 \times \text{L}19.50 \text{ mm}$, angle 2°	0.001
22.571-088/098	Reamer $\text{Ø } 0.88\text{...}0.98 \times \text{L}19.50 \text{ mm}$, angle 2°	0.001
22.571-096/106	Reamer $\text{Ø } 0.96\text{...}1.06 \times \text{L}19.50 \text{ mm}$, angle 2°	0.001
22.571-104/114	Reamer $\text{Ø } 1.04\text{...}1.14 \times \text{L}19.50 \text{ mm}$, angle 2°	0.001
22.571-112/122	Reamer $\text{Ø } 1.12\text{...}1.22 \times \text{L}19.50 \text{ mm}$, angle 2°	0.001
22.571-120/130	Reamer $\text{Ø } 1.20\text{...}1.30 \times \text{L}19.50 \text{ mm}$, angle 2°	0.001

Spare tool holder :

MSA	Item	Kg
22.568	Pivot, $\text{Ø } 4.70 \times \text{L}90 \text{ mm}$	0.011

Hard metal end mill.



MSA	Total length	Kg
22.558-270	25 mm (5 mm)	0.001

Hard metal end mill for dial feet.
- Shank \varnothing 3.00 ; cutting \varnothing 2.70 mm.

Tungsten carbide burs, shank \varnothing 2.35 mm.

Order example : MSA22.400-xxxx
(Extensions 3 digits = \varnothing head mm)

MSA22.400-002 = \varnothing head 0.20 mm
MSA22.400-027 = \varnothing head 2.70 mm

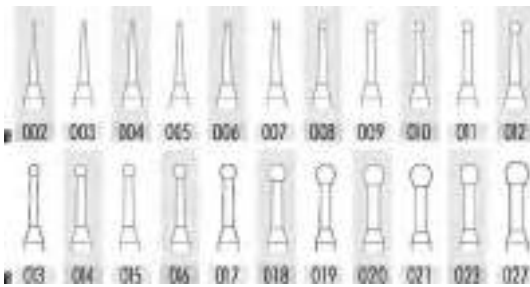

MSA	Type	Shape	\varnothing head	Kg
22.400-002	123	Round	0.20 mm	0.001
...
22.400-027	123	Round	2.70 mm	0.001

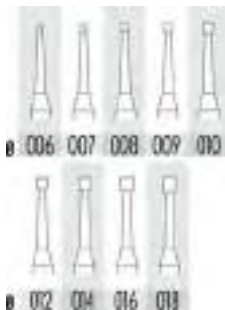

MSA	Type	Shape	\varnothing head	Kg
22.401-006	124	Inverted cone	0.60 mm	0.001
...
22.401-018	124	Inverted cone	1.80 mm	0.001



MSA	Type	Shape	\varnothing head	Kg
22.404-008	129	Cylindrical	0.80 mm	0.001
...
22.404-016	129	Cylindrical	1.60 mm	0.001



MSA	Type	Shape	\varnothing head	Kg
22.405-008	130	Cone	0.80 mm	0.001
...
22.405-018	130	Cone	1.80 mm	0.001

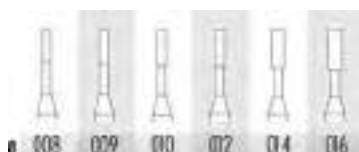

MSA	Type	Shape	\varnothing head	Kg
22.407-008	137	Cylindrical	0.80 mm	0.001
...
22.407-016	137	Cylindrical	1.60 mm	0.001



END MILLS

Order example : MSA22.400-xxxx
(Extensions 3 digits = Ø head mm)

MSA22.400-008 = Ø head 0.80 mm
MSA22.400-023 = Ø head 2.30 mm

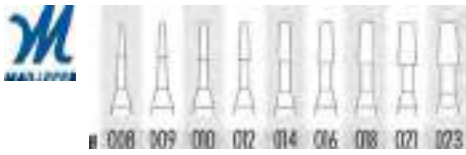

MSA	Type	Shape	Ø head	Kg
22.408-008	138	Cone	0.80 mm	0.001
...
22.408-023	138	Cone	2.30 mm	0.001



MSA	Type	Length	Ø head	Kg
22.450	Standard	12.20 mm	6 mm	0.002
22.450-F	Fine	12.20 mm	6 mm	0.002

Tool steel burs, shank Ø 2.35 mm.

Order example : MSA22.300-xxxx
(Extensions 3 digits = Ø head mm)

MSA22.300-003 = Ø head 0.30 mm
MSA22.300-100 = Ø head 10.00 mm

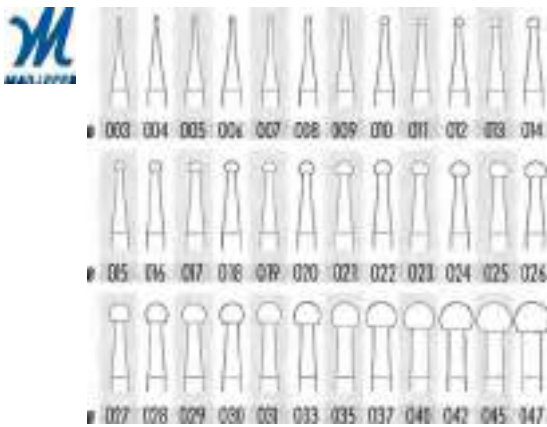

MSA	Type	Shape	Ø head	Kg
22.300-003	23	Round	0.30 mm	0.001
...
22.300-100	23	Round	10.00 mm	0.001

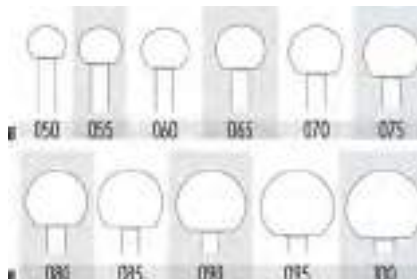

MSA	Type	Shape	Ø head	Kg
22.301-006	24	Inverted cone	0.60 mm	0.001
...
22.301-029	24	Inverted cone	2.90 mm	0.001

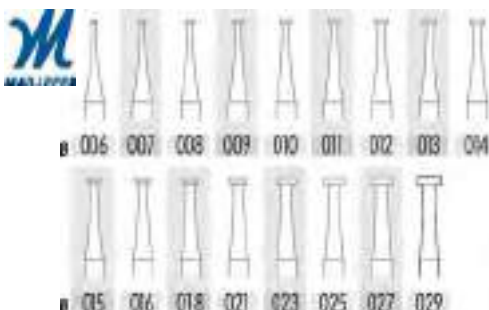

MSA	Type	Shape	Ø head	Kg
22.302-006	25	Wheel	0.60 mm	0.001
...
22.302-029	25	Wheel	2.90 mm	0.001



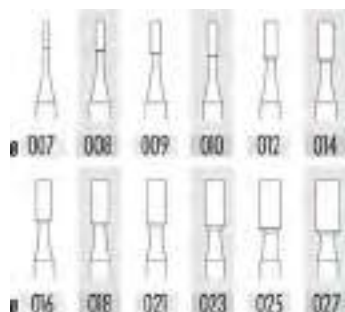

MSA	Type	Shape	Ø head	Kg
22.303-007	26	Cylindrical	0.70 mm	0.001
...
22.303-027	26	Cylindrical	2.70 mm	0.001

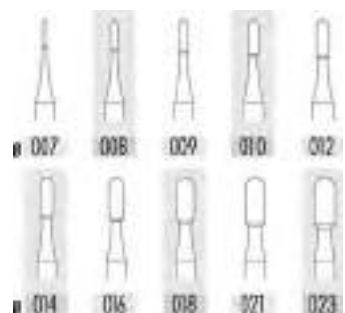

MSA	Type	Shape	Ø head	Kg
22.304-007	28	Cylindrical	0.70 mm	0.001
...
22.304-023	28	Cylindrical	2.30 mm	0.001

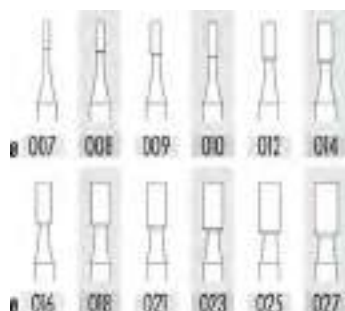

MSA	Type	Shape	Ø head	Kg
22.312-007	29	Cylindrical	0.70 mm	0.001
...
22.312-027	29	Cylindrical	2.70 mm	0.001



MSA	Type	Shape	Ø head	Kg
22.305-009	30	Cone	0.90 mm	0.001
...
22.305-025	30	Cone	2.50 mm	0.001

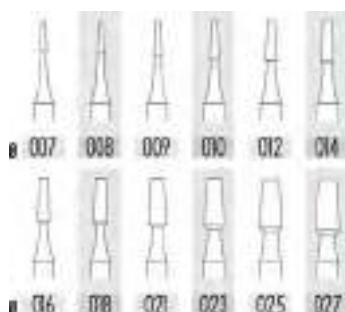

MSA	Type	Shape	Ø head	Kg
22.313-007	31	Cone	0.70 mm	0.001
...
22.313-027	31	Cone	2.70 mm	0.001



END MILLS

Order example : MSA22.306-xxxx
(Extensions 3 digits = Ø head mm)

MSA22.306-006 = Ø head 0.60 mm
MSA22.308-027 = Ø head 2.70 mm

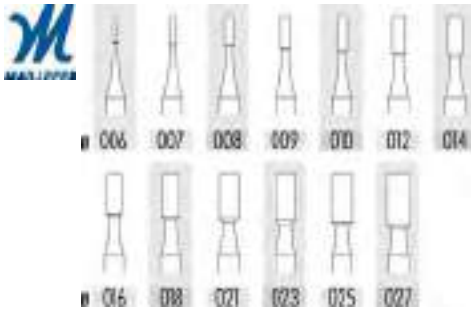

MSA	Type	Shape	Ø head	Kg
22.306-006	34	Cylindrical	0.60 mm	0.001
...
22.306-027	34	Cylindrical	2.70 mm	0.001

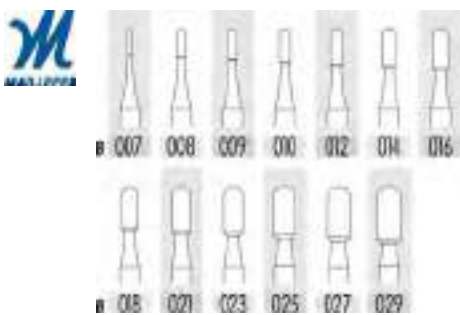

MSA	Type	Shape	Ø head	Kg
22.308-007	36	Cylindrical	0.70 mm	0.001
...
22.308-029	36	Cylindrical	2.90 mm	0.001

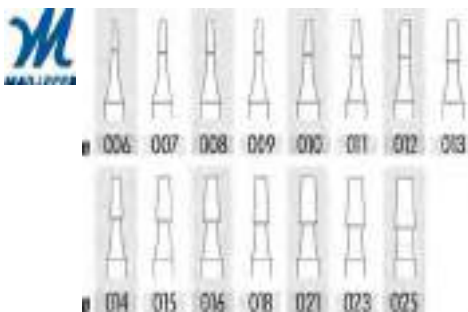

MSA	Type	Shape	Ø head	Kg
22.309-006	38	Cone	0.60 mm	0.001
...
22.309-025	38	Cone	2.50 mm	0.001



MSA	Type	Shape	Ø head	Kg
22.311-023	45	Wheel	2.30 mm	0.001
...
22.311-040	45	Wheel	4.00 mm	0.001

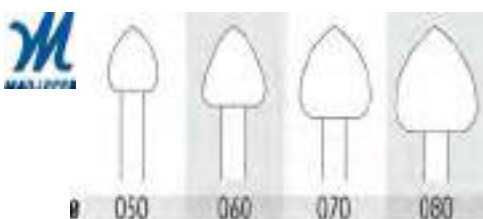

MSA	Type	Shape	Ø head	Kg
22.211-050	83	Bud	5.00 mm	0.001
...
22.211-080	83	Bud	8.00 mm	0.001



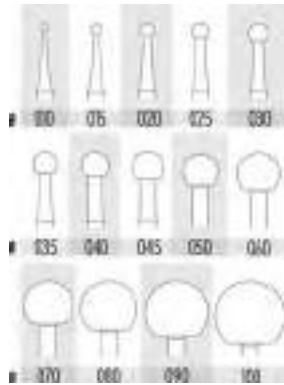

MSA	Type	Shape	Ø head	Kg
22.100-010	A	Fine round	1.00 mm	0.001
...
22.100-100	A	Fine round	10.00 mm	0.001



MSA	Type	Shape	Ø head	Kg
22.102-010	G	Fine flame	1.00 mm	0.001
...
22.102-050	G	Fine flame	5.00 mm	0.001



MSA	Type	Shape	Ø head	Kg
22.103-009	H	Double cone 120°	0.90 mm	0.001
...
22.103-050	H	Double cone 120°	5.00 mm	0.001



MSA	Type	Shape	Ø head	Kg
22.121-005	HB	Double cone 70°	0.50 mm	0.001
...
22.121-037	HB	Double cone 70°	3.70 mm	0.001



MSA	Type	Shape	Ø head	Kg
22.104-005	HD	Double cone 90°	0.50 mm	0.001
...
22.104-050	HD	Double cone 90°	5.00 mm	0.001



END MILLS

Order example : MSA22.105-xxxx
(Extensions 3 digits = Ø head mm)

MSA22.105-009 = Ø head 0.90 mm
MSA22.105-100 = Ø head 10.00 mm



MSA	Type	Shape	Ø head	Kg
22.105-009	HH	Lens	0.90 mm	0.001
...
22.105-100	HH	Lens	10.00 mm	0.001

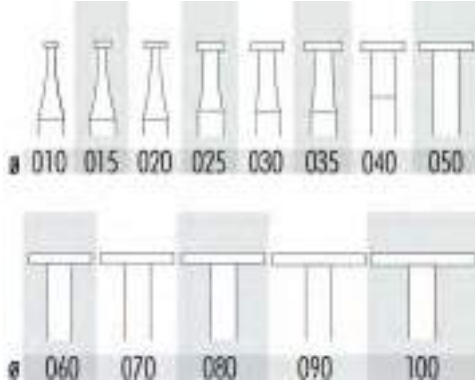

MSA	Type	Shape	Ø head	Kg
22.107-010	K	Wheel	1.00 mm	0.001
...
22.107-100	K	Wheel	10.00 mm	0.001

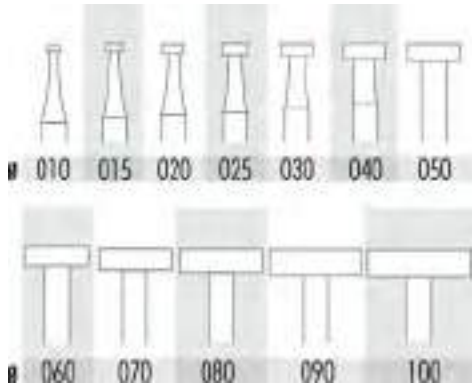

MSA	Type	Shape	Ø head	Kg
22.110-010	KK	Wheel	1.00 mm	0.001
...
22.110-100	KK	Wheel	10.00 mm	0.001

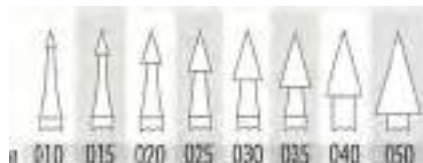

MSA	Type	Shape	Ø head	Kg
22.112-010	N	Cone 30°	1.00 mm	0.001
...
22.112-050	N	Cone 30°	5.00 mm	0.001



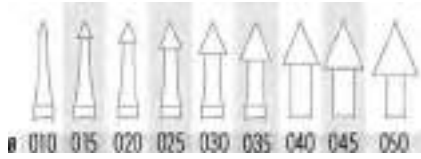

MSA	Type	Shape	Ø head	Kg
22.113-010	NN (fine)	Cone 45°	1.00 mm	0.001
...
22.113-050	NN (fine)	Cone 45°	5.00 mm	0.001

✂ 45°



MSA	Type	Shape	Ø head	Kg
22.123-008	NN (coarse)	Cone 45°	0.80 mm	0.001
...
22.123-050	NN (coarse)	Cone 45°	5.00 mm	0.001

✂ 45°



MSA	Type	Shape	Ø head	Kg
22.114-010	O	Cone 60°	1.00 mm	0.001
...
22.114-040	O	Cone 60°	4.00 mm	0.001

✂ 60°

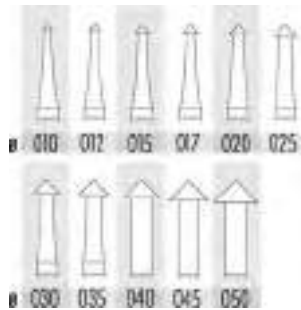

MSA	Type	Shape	Ø head	Kg
22.115-010	P	Cone 90°	1.00 mm	0.001
...
22.115-050	P	Cone 90°	5.00 mm	0.001

✂ 90°

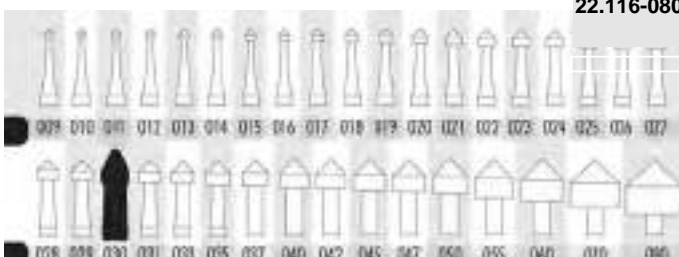

MSA	Type	Shape	Ø head	Kg
22.116-009	Q	Cylindrical sharpened	0.90 mm	0.001
...
22.116-080	Q	Cylindrical sharpened	8.00 mm	0.001



END MILLS

Order example : MSA22.117-xxxx
(Extensions 3 digits = Ø head mm)

MSA22.117-010 = Ø head 0.10 mm
MSA22.117-100 = Ø head 10.00 mm

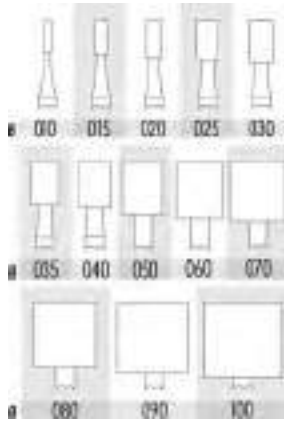

MSA	Type	Shape	Ø head	Kg
22.117-010	R	Cylindrical	1.00 mm	0.001
...
22.117-100	R	Cylindrical	10.00 mm	0.001

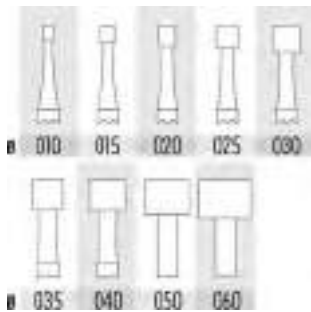

MSA	Type	Shape	Ø head	Kg
22.122-010	RR	Cylindrical	1.00 mm	0.001
...	0.001
22.122-060	RR	Cylindrical	6.00 mm	0.001

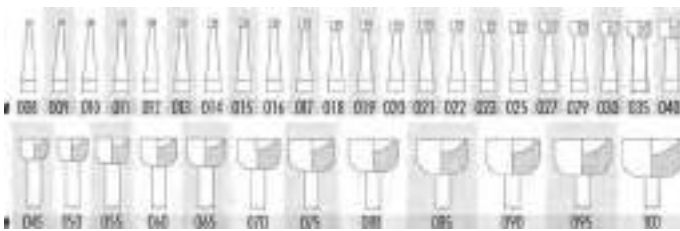

MSA	Type	Shape	Ø head	Kg
22.119-008	S	Cup	0.80 mm	0.001
...
22.119-100	S	Cup	10.00 mm	0.001

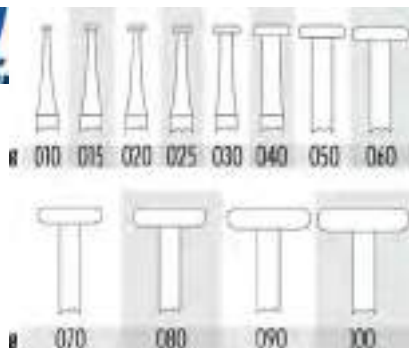

MSA	Type	Shape	Ø head	Kg
22.118-010	Y	Beveled wheel	1.00 mm	0.001
...	0.001
22.118-100	Y	Beveled wheel	10.00 mm	0.001



Assortments of 24 tool steel burs, delivered in a plastic box.



ASSORTMENT

MSA	Type	Ø shank	Kg
22.500	1235	2.35 mm	0.090

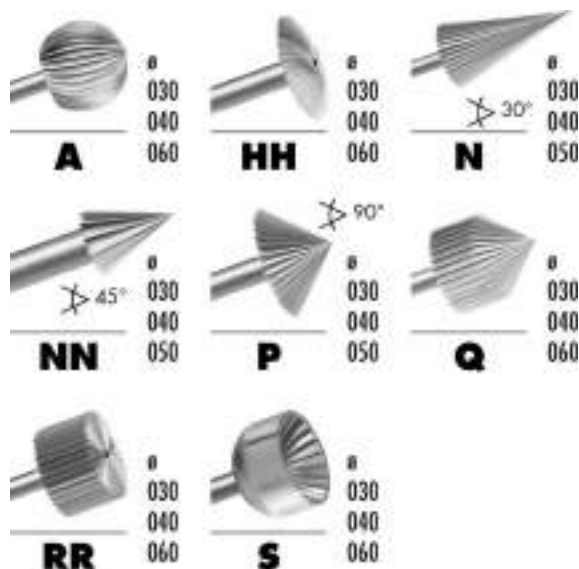

ASSORTMENT

MSA	Type	Ø shank	Kg
22.510	3235	2.35 mm	0.090

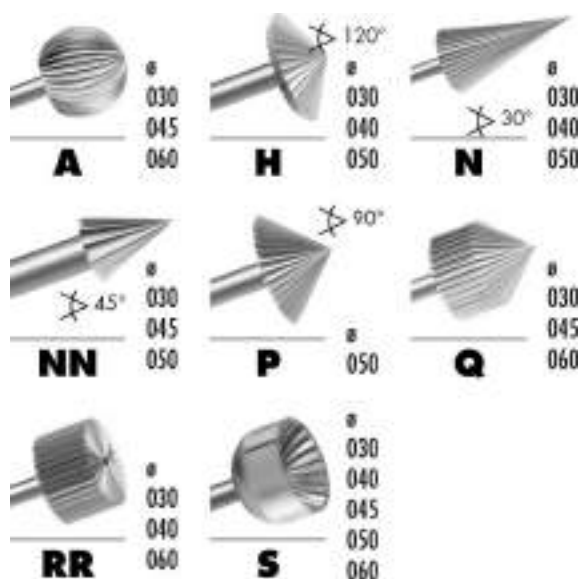



ASSORTMENT

MSA	Type	Ø shank	Kg
22.515	4235	2.35 mm	0.090

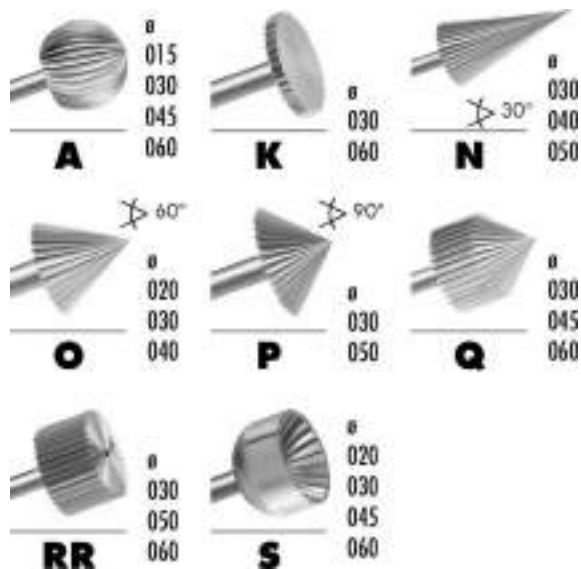

ASSORTMENT

MSA	Type	Ø shank	Kg
22.520	8235	2.35 mm	0.090

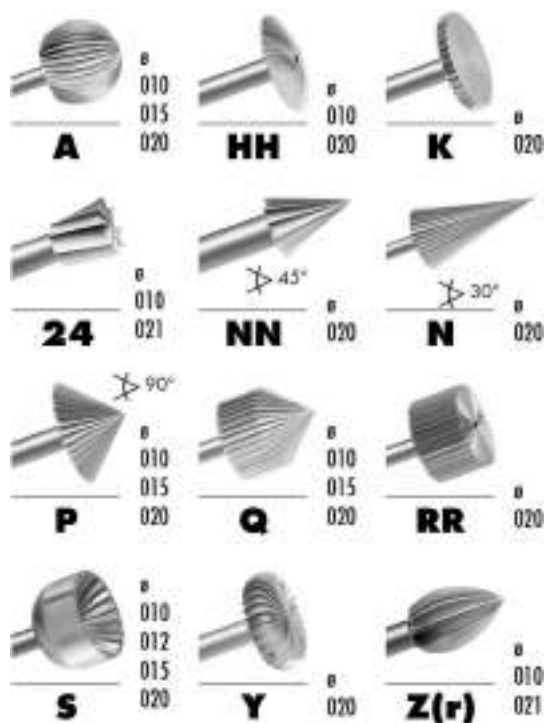

Order example : MSA22.723-xxxx
(Extensions 3 digits + 1 letter = Ø head mm + grain)

MSA22.723-016A = Ø 1.60 mm + grain super coarse
MSA22.723-023G = Ø 2.30 mm + grain ultra coarse

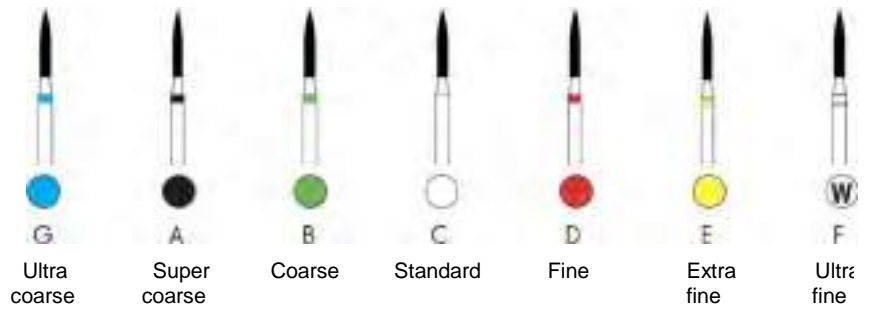

T. 368

MSA	Ø head 1.6 mm	Ø head 2.1 mm	Ø head 2.3 mm
22.723	-	-	-023G
22.723	-016A	-021A	-023A
22.723	-016B	-021B	-023B
22.723	-016C	-021C	-023C
22.723	-016D	-021D	-023D
22.723	-016E	-021E	-023E
22.723	-016F	-021F	-023F
-	-	-	-
L mm	3.50	5.00	5.00

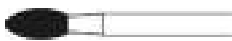

T. A368

MSA	Ø head 2.3 mm
22.739	-023B
22.739	-023C
22.739	-023D
22.739	-023E
-	-
L mm	5.00



T. A369

MSA	Ø head 2.3 mm
22.734	-023A
22.734	-023B
22.734	-023C
22.734	-023D
22.734	-023E
-	-
L mm	5.70



T. 379

MSA	Ø head 1.4 mm	Ø head 1.8 mm	Ø head 2.3 mm
22.722	-	-	-023G
22.722	-014A	-018A	-023A
22.722	-014B	-018B	-023B
22.722	-014C	-018C	-023C
22.722	-014D	-018D	-023D
22.722	-014E	-018E	-023E
22.722	-014F	-018F	-023F
-	-	-	-
L mm	3.00	3.50	4.50

DIAMOND BURS

Order example : MSA22.735-xxxx
(Extensions 3 digits + 1 letter = Ø head mm + grain)

MSA22.735-016C = Ø 1.60 mm + grain standard
MSA22.735-016E = Ø 1.60 mm + grain extra fine

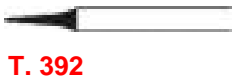
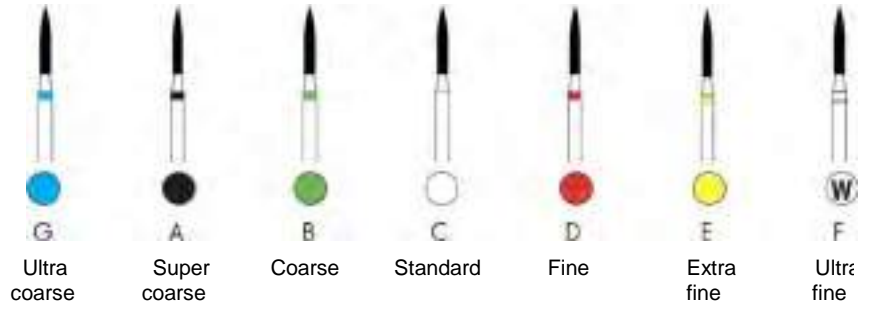

T. 392

MSA	Ø head 1.6 mm
22.735	-016C
22.735	-016D
22.735	-016E
-	-
L mm	5.00

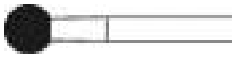

T. 801

MSA	Ø head 0.8 mm	Ø head 0.9 mm	Ø head 1.0 mm	Ø head 1.2 mm	Ø head 1.4 mm	Ø head 1.6 mm	Ø head 1.8 mm	Ø head 2.1 mm	Ø head 2.3 mm	Ø head 2.7 mm	Ø head 2.9 mm	Ø head 3.5 mm
22.701	-	-	-	-	-	-016G	-018G	-	-023G	-	-	-
22.701	-	-	-010A	-012A	-014A	-016A	-018A	-021A	-023A	-027A	-029A	-035A
22.701	-008B	-009B	-010B	-012B	-014B	-016B	-018B	-021B	-023B	-027B	-029B	-035B
22.701	-008C	-009C	-010C	-012C	-014C	-016C	-018C	-021C	-023C	-027C	-029C	-035C
22.701	-008D	-	-010D	-012D	-014D	-016D	-018D	-021D	-023D	-027D	-029D	-035D
22.701	-008E	-	-	-012E	-014E	-	-018E	-021E	-023E	-027E	-029E	-035E
22.701	-008F	-	-	-	-014F	-	-018F	-	-023F	-	-029F	-035F



T. A801

MSA	Ø head 1.6 mm
22.732	-016B
22.732	-016C
22.732	-016D

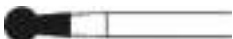

T. 802

MSA	Ø head 0.9 mm	Ø head 1.0 mm	Ø head 1.2 mm	Ø head 1.4 mm	Ø head 1.6 mm	Ø head 1.8 mm	Ø head 2.1 mm	Ø head 2.3 mm
22.702	-	-	-	-	-	-018A	-	-
22.702	-009B	-010B	-012B	-014B	-016B	-018B	-	-023B
22.702	-009C	-010C	-012C	-014C	-016C	-018C	021C	-023C
22.702	-	-	-	-014D	-	-	-	-
22.702	-	-	-	-	-	-018E	-	-
-	-	-	-	-	-	-	-	-
L mm	2.00	2.00	3.00	3.00	3.00	3.50	4.00	4.50

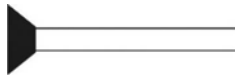

T. 805

MSA	Ø head 0.9 mm	Ø head 1.0 mm	Ø head 1.2 mm	Ø head 1.4 mm	Ø head 1.6 mm	Ø head 1.8 mm	Ø head 2.3 mm	Ø head 4.0 mm	Ø head 5.0 mm
22.703	-	-	-	-	-016A	-018A	-	-	-
22.703	-009B	-010B	-012B	-014B	-016B	-018B	-023B	-	-
22.703	-009C	-010C	-012C	-014C	-016C	-018C	-023C	-040C	-050C
22.703	-	-010D	-012D	-014D	-016D	-	-	-	-
-	-	-	-	-	-	-	-	-	-
L mm	↔ 1.00	1.00	1.50	1.50	1.50	1.50	2.00	1.50	2.00



T. 806

MSA	Ø head 0.9 mm	Ø head 1.0 mm	Ø head 1.2 mm	Ø head 1.4 mm	Ø head 1.6 mm	Ø head 1.8 mm	Ø head 2.3 mm
22.704	-	-	-	-014A	-	-	-
22.704	-	-010B	-012B	-014B	-016B	-018B	-
22.704	-009C	-010C	-012C	-014C	-016C	-018C	-023C
-	-	-	-	-	-	-	-
L mm	↔ 2.00	2.00	3.00	3.00	3.00	3.00	3.50



T. 807

MSA	Ø head 1.0 mm	Ø head 1.2 mm	Ø head 1.6 mm	Ø head 1.8 mm
22.705	-	-012A	-	-
22.705	-010B	-012B	-016B	-018B
22.705	-010C	-012C	-016C	-018C
-	-	-	-	-
L mm	↔ 3.00	3.50	4.00	5.00



T. 808

MSA	Ø head 1.8 mm	Ø head 2.3 mm
22.708	-018C	-023C
-	-	-
L mm	↔ 0.70	0.80

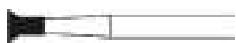

T. 809

MSA	Ø head 1.8 mm	Ø head 2.3 mm
22.709	-018C	-023C
-	-	-
L mm	↔ 2.00	2.50



T. 810

MSA	Ø head 4.0 mm	Ø head 5.0 mm
22.710	-040C	-050C
-	-	-
L mm	↔ 0.20	0.20

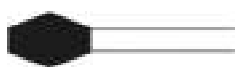

T. 811

MSA	Ø head 3.1 mm	Ø head 4.0 mm
22.714	-031A	-
22.714	-031B	-040B
22.714	-031C	-040C
-	-	-
L mm	↔ 4.00	6.00

DIAMOND BURS

Order example : MSA22.711-xxxx
(Extensions 3 digits + 1 letter = Ø head mm + grain)

MSA22.711-040C = Ø 4.00 mm + grain standard

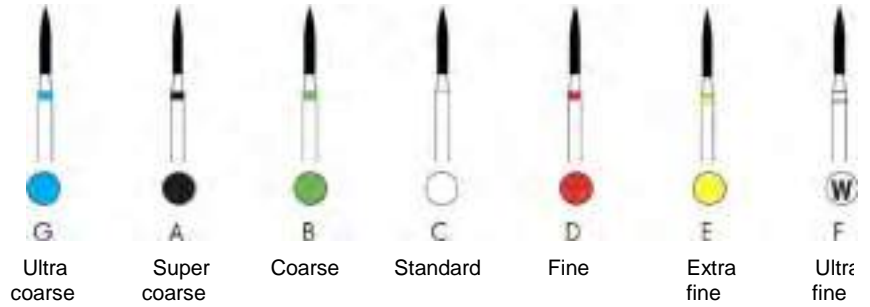
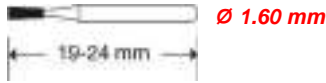

T. 812

MSA		Ø head 4.0 mm	Ø head 5.0 mm
22.711	□	-040C	-050C
-		-	-
L mm	↔	1.50	2.00



T. 813

MSA		Ø head 1.0 mm	Ø head 1.4 mm	Ø head 1.6 mm
22.712	■	-	-014A	-016A
22.712	■	-	-014B	-016B
22.712	□	-010C	-014C	-016C
22.712	■	-	-014D	-016D
-		-	-	-
L mm	↔	1.50	1.60	1.90



T. 813L

MSA		Ø head 1.4 mm	Ø head 1.6 mm
22.713	■	-014A	-016A
22.713	■	-014B	-016B
22.713	□	-014C	-016C
22.713	■	-014D	-016D
-		-	-
L mm	↔	3.00	3.00



T. 815

MSA		Ø head 1.2 mm	Ø head 1.6 mm	Ø head 1.8 mm	Ø head 2.3 mm
22.715	■	-012B	-016B	-	-
22.715	□	-012C	-016C	-018C	-023C
-		-	-	-	-
L mm	↔	0.50	0.70	0.70	0.80



T. 816

MSA		Ø head 1.2 mm	Ø head 1.6 mm	Ø head 1.8 mm
22.716	□	-012C	-016C	-018C
-		-	-	-
L mm	↔	1.50	1.80	2.00



T. 817

MSA		Ø head 3.3 mm	Ø head 4.0 mm	Ø head 5.0 mm
22.737	■	-033B	-040B	-050B
22.737	□	-033C	-040C	-050C
-	-	-	-	-
L mm	↔	0.70	0.70	0.70



T. 818

MSA		Ø head 3.3 mm	Ø head 4.0 mm	Ø head 5.0 mm
22.717	■	-	-040B	-050B
22.717	□	-033C	-040C	-050C
-	-	-	-	-
L mm	↔	1.00	1.00	1.00

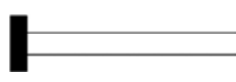

T. 819

MSA		Ø head 4.0 mm
22.738	□	-040C
-	-	-
L mm	↔	1.30



T. 820

MSA		Ø head 4.0 mm	Ø head 5.0 mm
22.718	□	-040C	-050C
-	-	-	-
L mm	↔	2.00	2.00



T. 822

MSA		Ø head 0.8 mm
22.733	■	-008B
22.733	□	-008C
22.733	■	-008D
22.733	■	-008E
-	-	-
L mm	↔	2.00

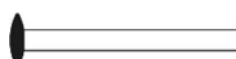

T. 825

MSA		Ø head 1.8 mm	Ø head 2.5 mm	Ø head 4.0 mm
22.720	■	-	-	-040B
22.720	□	-018C	-025C	-040C
-	-	-	-	-
L mm	↔	0.80	0.90	1.10



T. 826

MSA		Ø head 1.8 mm
22.721	□	-018C
-	-	-
L mm	↔	3.00

DIAMOND BURS

Order example : MSA22.706-xxxx
(Extensions 3 digits + 1 letter = Ø head mm + grain)

MSA22.706-012G = Ø 1.20 mm + grain ultra coarse
MSA22.706-016E = Ø 1.60 mm + grain extra fine

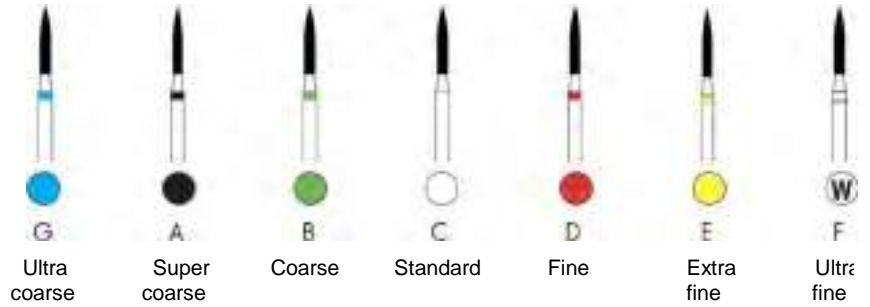
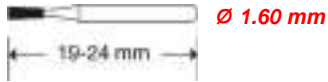

T. 830

MSA		Ø head 0.9 mm	Ø head 1.0 mm	Ø head 1.2 mm	Ø head 1.4 mm	Ø head 1.6 mm
22.706		-	-	-012G	-014G	-
22.706		-	-	-012A	-014A	-016A
22.706		-	-010B	-012B	-014B	-016B
22.706		-009C	-010C	-012C	-014C	-016C
22.706		-	-010D	-012D	-014D	-016D
22.706		-	-010E	-012E	-014E	-016E
-		-	-	-	-	-
L mm		3.00	3.00	3.00	3.00	3.00



T. 830L

MSA		Ø head 1.0 mm	Ø head 1.2 mm	Ø head 1.4 mm	Ø head 1.6 mm	Ø head 1.8 mm	Ø head 2.5 mm
22.707		-	-012G	-014G	-	-	-025G
22.707		-	-012A	-014A	-016A	-018A	-
22.707		-	-012B	-014B	-016B	-018B	-025B
22.707		-010C	-012C	-014C	-016C	-018C	-025C
22.707		-	-012D	-014D	-016D	-018D	-025D
22.707		-	-012E	-014E	-016E	-	-
-		-	-	-	-	-	-
L mm		4.00	4.00	5.00	5.00	5.00	7.00



T. 832

MSA		Ø head 2.7 mm
22.736		-027C
22.736		-027D
22.736		-027E
-		-
L mm		2.70

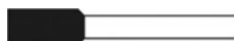







T. 835

MSA		Ø head 0.8 mm	Ø head 0.9 mm	Ø head 1.0 mm	Ø head 1.2 mm	Ø head 1.4 mm	Ø head 1.6 mm	Ø head 2.7 mm
22.741		-	-009A	-010A	-012A	-014A	-016A	-
22.741		-008B	-009B	-010B	-012B	-014B	-016B	-
22.741		-008C	-009C	-010C	-012C	-014C	-016C	-027C
22.741		-	-	-010D	-012D	-014D	-016D	-
22.741		-	-	-010E	-	-	-	-
-		-	-	-	-	-	-	-
L mm		3.00	3.00	4.00	4.00	4.00	4.00	5.00







T. 836



MSA		Ø head 1.0 mm	Ø head 1.2 mm	Ø head 1.4 mm	Ø head 1.8 mm	Ø head 2.7 mm
22.742		-	-012G	-014G	-	-027G
22.742		-010A	-012A	-014A	-	-
22.742		-010B	-012B	-014B	-018B	-
22.742		-010C	-012C	-014C	-018C	-027C
22.742		-010D	-012D	-014D	-018D	-027D
-		-	-	-	-	-
L mm		6.00	6.00	6.00	6.00	7.00







T. 837



MSA		Ø head 1.0 mm	Ø head 1.2 mm	Ø head 1.4 mm	Ø head 1.6 mm	Ø head 1.8 mm
22.743		-	-	-014G	-016G	-
22.743		-010A	-012A	-014A	-016A	-
22.743		-010B	-012B	-014B	-016B	-018B
22.743		-010C	-012C	-014C	-016C	-018C
22.743		-010D	-012D	-014D	-016D	-018D
-		-	-	-	-	-
L mm		7.00	8.00	8.00	8.00	8.00





T. 838



MSA		Ø head 0.8 mm	Ø head 0.9 mm	Ø head 1.0 mm	Ø head 1.2 mm
22.745		-	-	-	-012G
22.745		-	-	-010A	-012A
22.745		-	-	-010B	-012B
22.745		-008C	-009C	-010C	-012C
22.745		-	-	-010D	-012D
-		-	-	-	-
L mm		3.00	3.00	4.00	4.00





T. 842

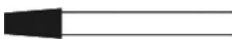

MSA		Ø head 1.2 mm	Ø head 1.4 mm	Ø head 1.6 mm	Ø head 1.8 mm
22.744		-	-014G	-016G	-018G
22.744		-012B	-014B	-016B	-018B
22.744		-012C	-014C	-016C	-018C
22.744		-012D	-014D	-016D	-
-		-	-	-	-
L mm		10.00	10.00	10.00	10.00

T. 845



MSA		Ø head 0.9 mm	Ø head 1.0 mm	Ø head 1.2 mm	Ø head 1.4 mm	Ø head 1.6 mm	Ø head 1.8 mm	Ø head 2.1 mm
22.756		-	-	-012A	-014A	-	-	-
22.756		-	-010B	-012B	-014B	-016B	-	-
22.756		-009C	-010C	-012C	-014C	-016C	-018C	-021C
22.756		-	-	-012D	-	-	-	-
-		-	-	-	-	-	-	-
L mm		3.00	4.00	4.00	4.00	4.00	4.00	4.00

DIAMOND BURS

Order example : MSA22.757-xxxx
(Extensions 3 digits + 1 letter = Ø head mm + grain)

MSA22.757-012A = Ø 1.20 mm + grain super coarse
MSA22.757-018F = Ø 1.80 mm + grain ultra fine

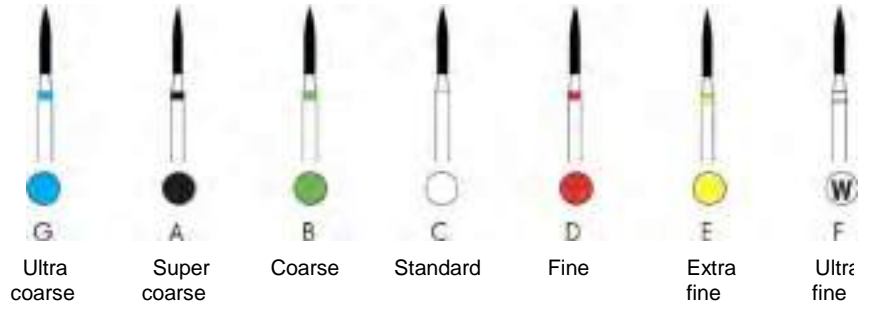

T. 846

MSA		Ø head 1.2 mm	Ø head 1.6 mm	Ø head 1.8 mm	Ø head 2.5 mm
22.757		-012A	-016A	-018A	-
22.757		-012B	-016B	-018B	-025B
22.757		-012C	-016C	-018C	-025C
22.757		-012D	-016D	-018D	-025D
22.757		-	-	-018E	-
22.757		-	-	-018F	-
-		-	-	-	-
L mm		6.00	6.00	6.00	7.00



T. 847

MSA		Ø head 1.2 mm	Ø head 1.4 mm	Ø head 1.6 mm	Ø head 1.8 mm	Ø head 2.1 mm
22.758		-012G	-	-016G	-018G	-
22.758		-012A	-014A	-016A	-018A	-021A
22.758		-012B	-014B	-016B	-018B	-021B
22.758		-012C	-014C	-016C	-018C	-021C
22.758		-012D	-014D	-016D	-018D	-021D
22.758		-	-	-016E	-	-
-		-	-	-	-	-
L mm		8.00	8.00	8.00	8.00	8.00



T. 848

MSA		Ø head 1.2 mm	Ø head 1.4 mm	Ø head 1.6 mm	Ø head 1.8 mm	Ø head 2.3 mm	Ø head 2.5 mm
22.759		-012G	-	-016G	-018G	-	-
22.759		-012A	-014A	-016A	-018A	-	-
22.759		-012B	-014B	-016B	-018B	-023B	025B
22.759		-012C	-014C	-016C	-018C	-023C	025C
22.759		-012D	-014D	-016D	-018D	-023D	025D
22.759		-	-	-016E	-	-023E	-
-		-	-	-	-	-	-
L mm		10.00	10.00	10.00	10.00	10.00	10.00



T. 849

MSA		Ø head 0.9 mm	Ø head 1.0 mm	Ø head 1.2 mm
22.760		-	-	-012G
22.760		-	-	-012A
22.760		-	-010B	-012B
22.760		-009C	-010C	-012C
22.760		-009D	-	-012D
22.760		-	-010E	-
-		-	-	-
L mm		4.00	4.00	4.00



T. 850

MSA		Ø head 1.2 mm	Ø head 1.4 mm	Ø head 1.6 mm	Ø head 1.8 mm	Ø head 2.3 mm
22.765		-012G	-014G	-016G	-018G	-023G
22.765		-012A	-014A	-016A	-018A	-023A
22.765		-012B	-014B	-016B	-018B	-023B
22.765		-012C	-014C	-016C	-018C	-023C
22.765		-012D	-014D	-016D	-018D	-023D
22.765		-012E	-	-016E	-	-023E
-		-	-	-	-	-
L mm		10.00	10.00	10.00	10.00	10.00



T. 852

MSA		Ø head 1.0 mm	Ø head 1.2 mm
22.766		-	-012A
22.766		-	-012B
22.766		-010C	-012C
22.766		-010D	-012D
22.766		-010E	-012E
22.766		-010F	-012F
-		-	-
L mm		4.00	6.00



T. 853

MSA		Ø head 0.8 mm
22.740		-008C
22.740		-008D
22.740		-008E
22.740		-008F
-		-
L mm		3.00



T. 855

MSA		Ø head 1.2 mm	Ø head 1.4 mm
22.762		-	-014G
22.762		-012A	-014A
22.762		-012B	-014B
22.762		-012C	-014C
22.762		-012D	-014D
-		-	-
L mm		7.00	7.00

DIAMOND BURS

Order example : MSA22.761-xxxx
(Extensions 3 digits + 1 letter = Ø head mm + grain)

MSA22.761-012B = Ø 1.20 mm + grain coarse
MSA22.761-012D = Ø 1.20 mm + grain fine

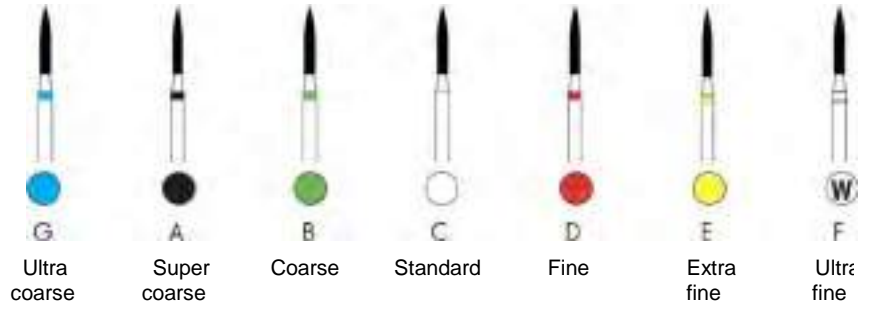

T. A855

MSA		Ø head 1.2 mm
22.761		-012B
22.761		-012C
22.761		-012D
-		-
L mm		6.00



T. 856

MSA		Ø head 1.2 mm	Ø head 1.4 mm	Ø head 1.6 mm	Ø head 1.8 mm	Ø head 2.3 mm
22.700		-012G	-014G	-016G	-018G	-023G
22.700		-012A	-014A	-016A	-018A	-023A
22.700		-012B	-014B	-016B	-018B	-023B
22.700		-012C	-014C	-016C	-018C	-023C
22.700		-012D	-014D	-016D	-018D	-023D
22.700		-	-014E	-016E	-	-023E
-		-	-	-	-	-
L mm		8.00	8.00	8.00	8.00	7.00



T. A856

MSA		Ø head 2.1 mm	Ø head 2.3 mm
22.764		-021G	-023G
22.764		-021A	-023A
22.764		-021B	-023B
22.764		-021C	-023C
22.764		-021D	-023D
22.764		-021E	-023E
-		-	-
L mm		8.00	8.00



T. 856L

MSA		Ø head 2.3 mm
22.763		-023G
22.763		-023A
22.763		-023B
22.763		-023C
22.763		-023D
-		-
L mm		8.00



T. 858

MSA		Ø head 1.2 mm	Ø head 1.4 mm	Ø head 1.6 mm	Ø head 1.8 mm
22.767	■	-	-014A	-	-
22.767	■	-012B	-014B	-016B	-018B
22.767	□	-012C	-014C	-016C	-018C
22.767	■	-012D	-014D	-016D	-
22.767	■	-012E	-014E	-016E	-
22.767	Ⓜ	-	-014F	-	-
-	-	-	-	-	-
L mm	↔	8.00	8.00	8.00	8.00



T. 859

MSA		Ø head 1.0 mm	Ø head 1.2 mm	Ø head 1.4 mm	Ø head 1.6 mm	Ø head 1.8 mm
22.768	■	-010A	-012A	-014A	-016A	-018A
22.768	■	-010B	-012B	-014B	-016B	-018B
22.768	□	-010C	-012C	-014C	-016C	-018C
22.768	■	-010D	-012D	-014D	-016D	-018D
22.768	■	-010E	-012E	-014E	-016E	-018E
22.768	Ⓜ	-	-012F	-	-016F	-018F
-	-	-	-	-	-	-
L mm	↔	10.00	10.00	10.00	10.00	10.00



T. 859L

MSA		Ø head 1.2 mm
22.769	□	-012C
-	-	-
L mm	↔	11.00



T. 860

MSA		Ø head 1.0 mm	Ø head 1.2 mm	Ø head 1.4 mm	Ø head 2.5 mm
22.728	■	-010A	-012A	-014A	-025A
22.728	■	-010B	-012B	-014B	-025B
22.728	□	-010C	-012C	-014C	-025C
22.728	■	-010D	-012D	-014D	-025D
22.728	■	-010E	-012E	-014E	-025E
22.728	Ⓜ	-010F	-	-	-025F
-	-	-	-	-	-
L mm	↔	4.00	5.00	5.00	6.00



T. 862

MSA		Ø head 0.9 mm	Ø head 1.0 mm	Ø head 1.2 mm	Ø head 1.4 mm	Ø head 1.6 mm
22.729	■	-	-	-012G	-014G	-
22.729	■	-	-010A	-012A	-014A	-016A
22.729	■	-	-010B	-012B	-014B	-016B
22.729	□	-009C	-010C	-012C	-014C	-016C
22.729	■	-009D	-010D	-012D	-014D	-016D
22.729	■	-	-010E	-012E	-014E	-
22.729	Ⓜ	-	-010F	-012F	-014F	-
-	-	-	-	-	-	-
L mm	↔	8.00	8.00	8.00	8.00	8.00

DIAMOND BURS

Order example : MSA22.730-xxxx
(Extensions 3 digits + 1 letter = Ø head mm + grain)

MSA22.730-014G = Ø 1.20 mm + grain ultra coarse
MSA22.730-018F = Ø 1.60 mm + grain ultra fine

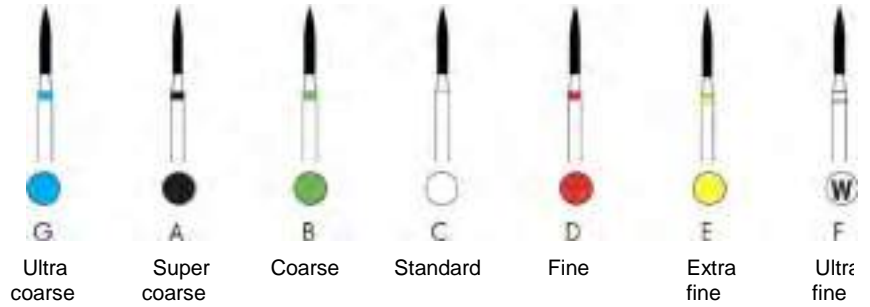

T. 863

MSA		Ø head 1.0 mm	Ø head 1.2 mm	Ø head 1.4 mm	Ø head 1.6 mm	Ø head 1.8 mm
22.730		-	-	-014G	-016G	-
22.730		-	-012A	-014A	-016A	-
22.730		-	-012B	-014B	-016B	-018B
22.730		-010C	-012C	-014C	-016C	-018C
22.730		-	-012D	-014D	-016D	-018D
22.730		-	-012E	-014E	-016E	-018E
22.730		-	-012F	-	-016F	-018F
-	-	-	-	-	-	-
L mm		10.00	10.00	10.00	10.00	10.00

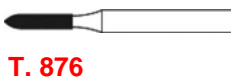

T. 876

MSA		Ø head 1.0 mm
22.752		-010B
22.752		-010C
22.752		-010D
22.752		-010E
-	-	-
L mm		5.00

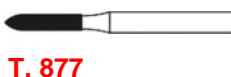

T. 877

MSA		Ø head 0.9 mm	Ø head 1.0 mm	Ø head 1.2 mm
22.753		-	-010A	-012A
22.753		-	-010B	-012B
22.753		-009C	-010C	-012C
22.753		-	-010D	-012D
22.753		-	-010E	-
-	-	-	-	-
L mm		6.00	6.00	6.00









T. 878

MSA		Ø head 0.9 mm	Ø head 1.0 mm	Ø head 1.2 mm	Ø head 1.4 mm	Ø head 1.6 mm
22.754		-	-010G	-012G	-014G	-
22.754		-	-010A	-012A	-014A	-016A
22.754		-	-010B	-012B	-014B	-016B
22.754		-009C	-010C	-012C	-014C	-016C
22.754		-	-010D	-012D	-014D	-016D
22.754		-009E	-010E	-012E	-014E	-
-	-	-	-	-	-	-
L mm		8.00	8.00	8.00	8.00	8.00







T. 879



MSA		Ø head 1.0 mm	Ø head 1.2 mm	Ø head 1.4 mm	Ø head 1.6 mm
22.755		-	-012G	-	-
22.755		-010A	-012A	-014A	-016A
22.755		-010B	-012B	-014B	-016B
22.755		-010C	-012C	-014C	-016C
22.755		-010D	-012D	-014D	-016D
22.755		-010E	-012E	-014E	--
-		-	-	-	-
L mm		10.00	10.00	10.00	10.00









T. 880



MSA		Ø head 1.2 mm	Ø head 1.4 mm	Ø head 1.6 mm	Ø head 1.8 mm
22.746		-012G	-	-	-
22.746		-012A	-014A	-016A	-018A
22.746		-012B	-014B	-016B	-018B
22.746		-012C	-014C	-016C	-018C
22.746		-012D	-014D	-016D	-
22.746		-	-014E	-	-
-		-	-	-	-
L mm		6.00	6.00	6.00	6.00







T. 881



MSA		Ø head 1.0 mm	Ø head 1.2 mm	Ø head 1.4 mm	Ø head 1.6 mm	Ø head 1.8 mm
22.747		-	-	-014G	-	-018G
22.747		-010A	-012A	-014A	-016A	-018A
22.747		-010B	-012B	-014B	-016B	-018B
22.747		-010C	-012C	-014C	-016C	-018C
22.747		-010D	-012D	-014D	-016D	-018D
22.747		-	-012E	-014E	-016E	-018E
22.747		-	-012F	-	-	-
-		-	-	-	-	-
L mm		8.00	8.00	8.00	8.00	8.00

T. 882



MSA		Ø head 1.2 mm	Ø head 1.4 mm
22.748		-012A	-014A
22.748		-012B	-014B
22.748		-012C	-014C
22.748		-012D	-014D
22.748		-012E	-014E
-		-	-
L mm		10.00	10.00

DIAMOND BURS

Order example : MSA22.726-xxxx
(Extensions 3 digits + 1 letter = Ø head mm + grain)

MSA22.726-010B = Ø 1.00 mm + grain coarse
MSA22.726-010D = Ø 1.00 mm + grain fine

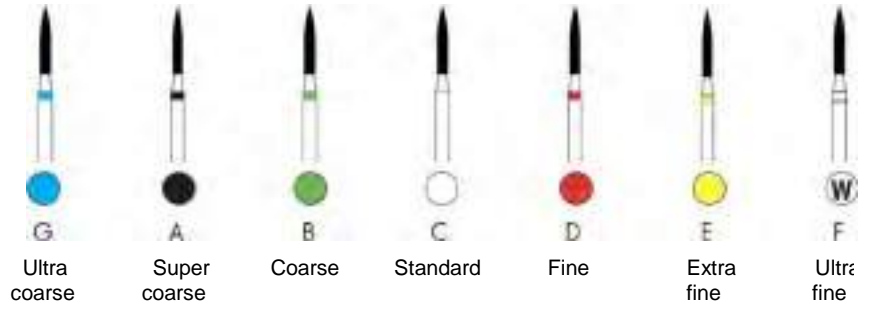
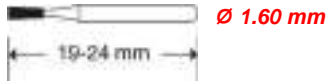

T. 883

MSA		Ø head 1.0 mm
22.726	■	-010B
22.726	□	-010C
22.726	●	-010D
-	-	-
L mm	↔	3.00



T. 884

MSA		Ø head 1.2 mm
22.749	■	-012A
22.749	■	-012B
22.749	□	-012C
22.749	●	-012D
22.749	●	-012E
-	-	-
L mm	↔	6.00



T. 885

MSA		Ø head 1.0 mm	Ø head 1.2 mm	Ø head 1.4 mm
22.750	■	-	-012A	-014A
22.750	■	-	-012B	-014B
22.750	□	-010C	-012C	-014C
22.750	●	-	-012D	-014D
22.750	●	-	-012E	-014E
-	-	-	-	-
L mm	↔	8.00	8.00	8.00



T. 886

MSA		Ø head 1.2 mm	Ø head 1.4 mm	Ø head 1.6 mm
22.751	■	-012A	-014A	-
22.751	■	-012B	-014B	-016B
22.751	□	-012C	-014C	-016C
22.751	●	-012D	-014D	-016D
22.751	●	-012E	-014E	-
-	-	-	-	-
L mm	↔	10.00	10.00	10.00



T. 888

MSA		Ø head 1.2 mm
22.731	■	-012A
22.731	■	-012B
22.731	□	-012C
22.731	■	-012D
22.731	■	-012E
-		-
L mm	↔	8.00



T. 889

MSA		Ø head 0.9 mm	Ø head 1.0 mm
22.727	■	-009B	-010B
22.727	□	-009C	-010C
22.727	■	-009D	-010D
22.727	■	-009E	-010E
22.727	⊙	-009F	-010F
-		-	-
L mm	↔	3.50	4.50



T. 890

MSA		Ø head 1.6 mm
22.724	■	-016B
22.724	□	-016C
22.724	■	-016D
22.724	■	-016E
22.724	⊙	-016F
-		-
L mm	↔	4.00



T. 899

MSA		Ø head 2.1 mm	Ø head 2.7 mm	Ø head 3.1 mm
22.725	■	-021A	-027A	-031A
22.725	■	-021B	-027B	-031B
22.725	□	-021C	-027C	-031C
22.725	■	-021D	-027D	-031D
-		-	-	-
L mm	↔	6.50	7.00	7.00

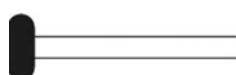

T. 909

MSA		Ø head 3.3 mm	Ø head 4.0 mm	Ø head 5.0 mm
22.719	■	-	-040A	-
22.719	■	-033B	-040B	-
22.719	□	-033C	-040C	-050C
-		-	-	-
L mm	↔	1.00	1.70	2.20

DIAMOND BURS

Order example : MSA22.803-xxxx
(Extensions 3 digits + 1 letter = Ø head mm + grain)

MSA22.803-018C = Ø 1.80 mm + grain standard
MSA22.803-040B = Ø 4.00 mm + grain coarse

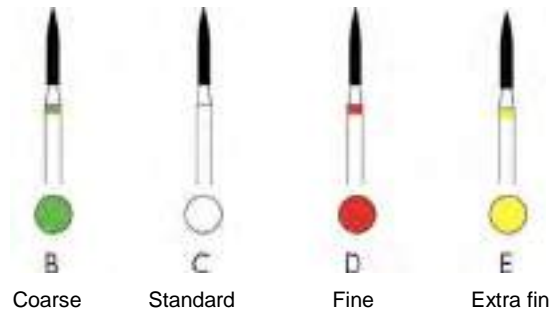
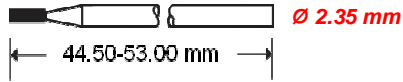

MSA	Ø head 1.8 mm	Ø head 2.5 mm	Ø head 4.0 mm
T. 825			
22.803	-	-	-040B
22.803	-018C	-025C	-040C
-	-	-	-
L mm	0.80	0.90	1.10

MSA	Ø head 1.2 mm	Ø head 1.6 mm
T. 858		
22.800	-012C	-016C
22.800	-012D	-016D
-	-	-
L mm	8.00	8.00

MSA	Ø head 1.4 mm
T. 859	
22.801	-014C
-	-
L mm	10.00

MSA	Ø head 3.3 mm	Ø head 4.0 mm	Ø head 5.0 mm
T. 909			
22.802	-	-040B	-
22.802	-033C	-040C	-050C
-	-	-	-
L mm	1.00	1.70	2.20

MSA	Ø head 1.4 mm
166F	
22.805	-F014

MSA	Ø head 1.2 mm
248F	
22.806	-F012

MSA	Ø head 1.6 mm
272F	
22.807	-F016

SPIREC HSS-E micro-drills, high speed steel.



Precise the Ø when placing your order.

Examples :

MSA22.630-0.05 for Ø 0.05 mm

MSA22.630-1.50 for Ø 1.50 mm

MSA22.630-2.00 for Ø 2.00 mm

MSA	Length	Ø shank	Ø	Progression	Kg
22.630-0.05	25 mm	1.00 mm	0.05 mm	0.01 mm	0.001
...
22.630-0.79	25 mm	1.00 mm	0.79 mm	0.01 mm	0.001
22.630-0.80	25 mm	1.50 mm	0.80 mm	0.01 mm	0.001
...
22.630-1.00	25 mm	1.50 mm	1.00 mm	0.01 mm	0.001
22.630-1.05	25 mm	1.50 mm	1.05 mm	0.05 mm	0.001
...
22.630-1.45	25 mm	1.50 mm	1.45 mm	0.05 mm	0.001
=====					
22.630-1.50	38 mm	2.00 mm	1.50 mm	-	0.001
22.630-1.55	38 mm	2.00 mm	1.55 mm	-	0.001
22.630-1.58	38 mm	2.00 mm	1.587 mm	-	0.001
22.630-1.60	38 mm	2.00 mm	1.60 mm	0.05 mm	0.001
...
22.630-1.95	38 mm	2.00 mm	1.95 mm	0.05 mm	0.001
22.630-1.98	38 mm	2.00 mm	1.984 mm	-	0.001
=====					
22.630-2.00	43 mm	2.50 mm	2.00 mm	0.05 mm	0.001
...
22.630-2.35	43 mm	2.50 mm	2.35 mm	0.05 mm	0.001
22.630-2.38	43 mm	2.50 mm	2.384 mm	-	0.001
22.630-2.40	43 mm	2.50 mm	2.40 mm	-	0.001
22.630-2.45	43 mm	2.50 mm	2.45 mm	-	0.001
=====					
22.630-2.50	46 mm	3.00 mm	2.50 mm	0.05 mm	0.001
...
22.630-2.75	46 mm	3.00 mm	2.75 mm	0.05 mm	0.001
22.630-2.77	46 mm	3.00 mm	2.778 mm	-	0.001
22.630-2.80	46 mm	3.00 mm	2.80 mm	0.05 mm	0.001
...
22.630-3.00	46 mm	3.00 mm	3.00 mm	0.05 mm	0.001
22.630-3.17	46 mm	3.00 mm	3.175 mm	-	0.001

TITEX HSS micro-drills, standard for universal use.



Precise the Ø when placing your order.

Examples :

MSA22.660-020 for Ø 0.20 mm

MSA22.660-205 for Ø 2.05 mm

MSA22.660-1000 for Ø 10.00 mm

MSA	Ø	Progression	Kg
22.660-020	0.20 mm	0.01 mm	0.001
...
22.660-200	2.00 mm	0.01 mm	0.001
=====			
22.660-205	2.05 mm	0.05 mm	0.001
...
22.660-995	9.95 mm	0.05 mm	0.001
=====			
22.660-1000	10.00 mm	0.10 mm	0.001
...
22.660-1690	16.90 mm	0.10 mm	0.001

YAMAMOTO HSS micro-drills.



MSA	Ø shank	Ø	Progression	Kg
22.670-010	1.00 mm	0.10 mm	0.01 mm	0.001
...
22.670-075	1.00 mm	0.75 mm	0.01 mm	0.001
=====	=====	=====	=====	=====
22.670-076	1.50 mm	0.76 mm	0.01 mm	0.001
...
22.670-125	1.50 mm	1.25 mm	0.01 mm	0.001
=====	=====	=====	=====	=====
22.670-130	1.50 mm	1.30 mm	-	0.001
=====	=====	=====	=====	=====
22.670-135	2.00 mm	1.35 mm	0.05 mm	0.001
...
22.670-150	2.00 mm	1.50 mm	0.05 mm	0.001

Precise the Ø when placing your order.

Examples :

MSA22.670-010 for Ø 0.10 mm

MSA22.670-076 for Ø 0.76 mm

MSA22.670-135 for Ø 1.35 mm

SPIREC micro-drills in hardened steel.



MSA	Ø shank	Ø	Progression	Total length	Kg
22.640-0.05	1.00 mm	0.05 mm	0.01 mm	25 mm	0.001
...
22.640-0.79	1.00 mm	0.79 mm	0.01 mm	25 mm	0.001
=====	=====	=====	=====	=====	=====
22.640-0.80	1.50 mm	0.80 mm	0.01 mm	25 mm	0.001
...
22.640-1.50	1.50 mm	1.50 mm	0.01 mm	25 mm	0.001
=====	=====	=====	=====	=====	=====
22.640-1.51	2.00 mm	1.51 mm	0.01 mm	38 mm	0.001
...
22.640-2.00	2.00 mm	2.00 mm	0.01 mm	38 mm	0.001

Precise the Ø when placing your order.

Examples :

MSA22.640-0.05 for Ø 0.05 mm

MSA22.640-0.80 for Ø 0.80 mm

MSA22.640-1.51 for Ø 1.51 mm

Tempered tool steel drills 58PM type, shank Ø 2.35 mm.



MSA	Ø	Kg	MSA	Ø	Kg
22.610-005	0.50 mm	0.001	22.610-015	1.50 mm	0.001
22.610-006	0.60 mm	0.001	22.610-016	1.60 mm	0.001
22.610-007	0.70 mm	0.001	22.610-017	1.70 mm	0.001
22.610-008	0.80 mm	0.001	22.610-018	1.80 mm	0.001
22.610-009	0.90 mm	0.001	22.610-019	1.90 mm	0.001
22.610-010	1.00 mm	0.001	22.610-020	2.00 mm	0.001
22.610-011	1.10 mm	0.001	22.610-021	2.10 mm	0.001
22.610-012	1.20 mm	0.001	22.610-022	2.20 mm	0.001
22.610-013	1.30 mm	0.001	22.610-023	2.30 mm	0.001
22.610-014	1.40 mm	0.001			

Tungsten carbide drills 58MD type, shank Ø 2.35 mm.



MSA	Ø	Kg	MSA	Ø	Kg
22.412-005	0.50 mm	0.001	22.412-015	1.50 mm	0.001
22.412-006	0.60 mm	0.001	22.412-016	1.60 mm	0.001
22.412-007	0.70 mm	0.001	22.412-017	1.70 mm	0.001
22.412-008	0.80 mm	0.001	22.412-018	1.80 mm	0.001
22.412-009	0.90 mm	0.001	22.412-019	1.90 mm	0.001
22.412-010	1.00 mm	0.001	22.412-020	2.00 mm	0.001
22.412-011	1.10 mm	0.001	22.412-021	2.10 mm	0.001
22.412-012	1.20 mm	0.001	22.412-022	2.20 mm	0.001
22.412-013	1.30 mm	0.001	22.412-023	2.30 mm	0.001
22.412-014	1.40 mm	0.001			

Diamond drills, shank Ø 2.35 mm.



MSA	Ø	Kg
22.650-080	0.80 mm	0.003
22.650-090	0.90 mm	0.003
22.650-100	1.00 mm	0.003
22.650-110	1.10 mm	0.003
22.650-130	1.30 mm	0.003
22.650-140	1.40 mm	0.003
22.650-150	1.50 mm	0.003

Hardened steel drills for poising of watch balances.



MSA	d1	Dh6	Angle	l1	L	Kg
22.572-017	0.17 mm	1.50 mm	16°	0.6 mm	21 mm	0.001
22.572-018	0.18 mm	1.50 mm	16°	0.6 mm	21 mm	0.001
22.572-019	0.19 mm	1.50 mm	16°	0.6 mm	21 mm	0.001
22.572-020	0.20 mm	1.50 mm	16°	0.6 mm	21 mm	0.001
22.572-021	0.21 mm	1.50 mm	16°	0.6 mm	21 mm	0.001
22.572-022	0.22 mm	1.50 mm	16°	0.6 mm	21 mm	0.001

23



POLISHING TOOLS

23 - 2

POLISHING MACHINES

23 - 5

SANDBLASTERS / SUCTION

23 - 9

POLISHING TOOLS

Hand polishing system developed for the watch industry, particularly for watch cases finish, and modified by HOROTEC® for the after sales service.

These 2 versions tools are composed of a vice with 4 brass claws (inside tightening from Ø 14 to 34 mm and from Ø 25 to 50) mounted on ball bearings, allowing the POLISHING WITHOUT RISKING ANY FLATTENING on the item worked on (watch case, bezel, case back, ring, etc.). As soon as one comes in contact with the brush, the system starts turning at the same speed as the brush.



(1)



(2)



MSA	Model	Kg
23.501	(1) Bobino with vice MSA23.501-A (clockwise threading), Ø 14...34 mm	0.780
23.504	(2) Bobino with vice MSA23.504-A (clockwise threading), Ø 25...50 mm	0.780

MSA	Model	Kg
23.502	(1) Bobino with vice MSA23.501-E (counter clockwise threading), Ø 14...34 mm	0.780
23.505	(2) Left turning Bobino MSA23.504-E (counter clockwise threading), Ø 25...50 mm	0.780

Delivered with an Allen key to adjust the separation of the 4 claws and to block the vice on the threading of the Bobino. The back screw is used to adjust the rotation of the Bobino. It allows to completely stop it or to have a free rotation. The underneath lever allows to tighten the claws for a quick change of the polishing parts.



There is no more contact between the fingers and the item to polish.

For voluntary blocking, just hold the base of the red vice.





MSA	Model	Kg
23.501-C	Bobino (clockwise threading), thread Ø 16 mm	0.700
23.501-B	Bobino (counter clockwise threading), thread Ø 16 mm	0.700

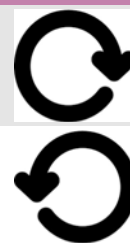

Delivered with 1 Allen key.



MSA	Size	Kg
23.501-P	Ø 32 x 90 mm	0.050

Handle for polishing tools MSA23.501, MSA23.502, MSA23.504, MSA23.505, MSA23.501-B et MSA23.501-C.

HOROTEC



MSA	Model	Kg
23.501-A	Vice (clockwise threading), thread Ø 16 mm	0.080
23.501-E	Vice (counter clockwise threading), thread Ø 16 mm	0.080

Spare parts :

MSA	Item	Kg
23.500-A	Assortment of 4 claws	0.010
23.501-G	Spring	0.001



Delivered with an Allen key to adjust the separation of the 4 claws (Ø 14 to 34 mm) and to block the vice on the threading of the Bobino.

HOROTEC



MSA	Model	Kg
23.504-A	Vice (clockwise threading), thread Ø 16 mm	0.080
23.504-E	Vice (counter clockwise threading), thread Ø 16 mm	0.080

Spare parts :

MSA	Item	Kg
23.503-A	Assortment of 4 claws	0.010
23.504-G	Spring	0.001



Delivered with an Allen key to adjust the separation of the 4 claws (Ø 25 to 50 mm) and to block the vice on the threading of the Bobino.

MANUAL USE : the brass claws adjustment is made by clockwise turning the end cylinder ; the item to polish is hold from the inside. Used by handling the hexagonal vice during the polishing.

USE ON POLISHING MOTOR ARBOUR : first fix the piece to be polished on the brass claws, then fix the vice on the polishing motor arbour and tighten it with 2 screws using the provided hexagonal key.

The end cylinder is reamed to about Ø 14 mm, to fix the vice on the motor arbour.

Optional reduction die is deliverable to fit the vice on Ø 9 mm motor axle.



MSA	Ø reaming	Size	Kg
23.500	14 mm	Ø 35 x 80 mm	0.250

Polishing vice with 4 brass claws, tightening from Ø 14 to 34 mm.

Spare parts :

MSA	Item	Kg
23.500-09	Reduction die Ø 9 mm	0.016
23.500-A	Assortment of 4 claws	0.010
23.500-V	Maintaining screw of axis	0.001
23.501-G	Spring	0.001



MSA	Ø reaming	Size	Kg
23.503	14 mm	Ø 39 x 80 mm	0.180

Polishing vice with 4 brass claws, tightening from Ø 25 to 50 mm.

Spare parts :

MSA	Item	Kg
23.500-09	Reduction die Ø 9 mm	0.016
23.500-V	Maintaining screw of axis	0.001
23.503-A	Assortment of 4 claws	0.010
23.504-G	Spring	0.001

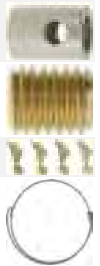

PRE CITEC
QUALITY

POLYTEC

This range of polishing machines with its modern and ergonomic design has superior technical characteristics (most powerful motor in its class) and differs from other devices in numerous points.

Six different models are currently available with 1 or 2 workstations.

- Extremely user-friendly
- Folding plexiglas protection cover over the working area
- Provides exceptionally good absorption performance with its revised air transfer
- Polishing with this machine provides fully professional conditions of work and guarantees you performance, reliability and longevity
- Regardless of the pressure applied on the brushes, the torque remains constant (no decrease in rotation speed)
- A complete list of spare parts available like spindles, adaptors, filters and protections.



TOUCH-SENSITIVE



2 spindles

MSA	Voltage	Speeds	Rotations/minute	Size WxDxH	Kg
23.005	230 V	Adjustable *	300...3'000	680 x 370 x 460 mm	43.200
23.005-110	115 V	Adjustable *	300...3'000	680 x 370 x 460 mm	43.200

Features :

- Vacuum : 750 m3/hour (each side)
- Lighting : 4x 9 LED 1600 Lumen (each side)
- Ø brush : 160 mm maximum
- Motor power : 0.55 kW, constant torque
- Power supply : 230 or 115 V (50 Hz).

* Adjustable speed from 300 to 3000 rotations/minute in steps of 5 rotations/minute.
The selected speed is shown on the display.

POLISHING MACHINES



MSA23.003

2 spindles



MSA23.004

MSA	Voltage	Speeds	Rotations/minute	Size WxDxH	Kg
23.003	230 V	2	1'500 - 3'000	680 x 370 x 460 mm	52.000
23.004	230 V	Adjustable *	300...3'000	680 x 370 x 460 mm	49.000

Features :

- Vacuum : 750 m3/hour (each side)
- Lighting : 4x 9 LED 1600 Lumen (each side)
- Ø brush : 160 mm maximum
- Motor power : 0.55 kW, constant torque
- Power supply : 230 V (50 Hz).

* Adjustable speed from 300 to 3000 rotations/minute with a VARIO button.



MSA23.000



MSA23.001



MSA23.002

MSA	Voltage	Speeds	Rotations/minute	Size WxDxH	Kg
23.000	230 V	1	3'000	460 x 370 x 460 mm	34.000
23.001	230 V	2	1'500 - 3'000	460 x 370 x 460 mm	38.000
23.002	230 V	Adjustable *	300...3'000	460 x 370 x 460 mm	34.000

Features :

- Vacuum : 750 m3/hour (each side)
- Lighting : 4x 9 LED 1600 Lumen (each side)
- Ø brush : 160 mm maximum
- Motor power : 0.55 kW, constant torque
- Power supply : 230 V (50 Hz).

* Adjustable speed from 300 to 3000 rotations/minute with a VARIO button.



MSA	Speeds	Rotations/minute	Size WxDxH	Kg
23.600	2	1'500 - 3'000	310 x 240 x 285 mm	13.500

Polishing motor.
 Motor power : 0.50 kW.
 Power supply : 220/240 V.



Spare parts :

MSA	Item	Kg
23.600-A	(1) Right-sided tapered spindle	0.067
23.600-B	Left-sided tapered spindle	0.067



MSA	Size WxDxH	Kg
23.601	250 x 240 x 285 mm	3.100

Dust collector for polishing motor MSA23.600.

POLISHING MACHINES

Spare parts for the polishing machines PRECITEC®.



MSA	Size	Kg
23.000-A	227 x 216 mm	0.143

Plexiglas protection.



MSA	Size	Kg
23.000-B	265 x 190 x 16 mm	0.026

Fibre filtre.



MSA	Size	Kg
23.000-C	258 x 178 x 48 mm	0.106

Cartridge filtre.



MSA	Size	Kg
23.000-D	Ø 68 x 140 mm	0.683

Grinding wheel.



MSA	Size	Kg
23.000-E	Ø 34 x 145 mm	0.228

Right-sided tapered spindle.



MSA	Size	Kg
23.000-F	Ø 34 x 145 mm	0.228

Left-sided tapered spindle.



MSA	Size	Kg
23.000-G	165 x 36 mm	0.041

Left LED.



MSA	Size	Kg
23.000-H	165 x 36 mm	0.041

Right LED.



MSA	Model	Size	Kg
23.000-I	Left side	230 x 370 x 230 mm	1.380
23.000-J	Right side	230 x 370 x 230 mm	1.380

Protection cover.



MSA	Size	Kg
23.000-K	27 x 40 x 37 mm	0.015

Power switch On/Off.

Microsandblasters.



(1)



(2)

MSA	Model	Voltage	Size WxDxH	Kg
23.800	(1) 2 containers	230 V	400 x 420 x 330 mm	18.000
23.801	(2) 3 containers	230 V	400 x 420 x 330 mm	20.000

Ergonomic microsandblaster for the surface treatment of metals, resins and ceramics.

- Anti-humidity system
- Precise sanding
- Pneumatic foot pedals.

Spare parts :

MSA	Item	Kg
23.800-T08	Tip, Ø 0.80 cm / For grain 50-100 µ	0.005
23.800-T12	Tip, Ø 1.20 cm / For grain 80-180 µ and glass beads	?
23.800-T15	Tip, Ø 1.50 cm / For grain 150-250 µ	?
23.808-A	Complete air filter with pressure gauge	0.262
23.808-B	Neon lamp	?
23.808-C	Glass protection, pack 5 pieces	?
23.808-D	Spare glove	0.074
23.808-E	Complete air syringe	?

Consumables :

MSA	Item	Kg
23.809-050	High purity aluminium oxide, silicium free. Grain 50 µ, bottle of 5 Kg	?
23.809-100	High purity aluminium oxide, silicium free. Grain 100 µ, bottle of 5 Kg	?
23.809-150	High purity aluminium oxide, silicium free. Grain 150 µ, bottle of 5 Kg	?
23.809-200	High purity aluminium oxide, silicium free. Grain 200 µ, bottle of 5 Kg	?
23.809-250	High purity aluminium oxide, silicium free. Grain 250 µ, bottle of 5 Kg	5.135
23.809-GB	Glass beads	?

It is recommended to use the microsandblasters with the following suction systems.

Suction systems.



MSA	Power	Size WxDxH	Kg
23.810	400-1000 W	330 x 250 x 380 mm	12.000

Portable unit for suction of dust, residues and abrasives. This professional and silent device has an adjustable suction power and is equipped with 4 fabric filters.

- For use with the microsandblasters MSA23.800 and MSA23.801 and the cabinets MSA23.812 and MSA23.813.

Spare parts :

MSA	Item	Kg
23.819-A	Spare motor filter	?
23.819-B	Spare filter, 4 pieces	?
23.819-C	Air hose, 2 metres	?



MSA	Power	Size WxDxH	Kg
23.811	400-1000 W	330 x 330 x 380 mm	15.000

Portable double unit for suction of dust, residues and abrasives.
 For diversified simultaneous use.
 This professional and silent device has an adjustable suction power and is equipped with 4 fabric filters.
 - For use with the microsandersblasters MSA23.800 and MSA23.801 and the cabinets MSA23.812 and MSA23.813.

Spare parts :

MSA	Item	Kg
23.819-A	Spare motor filter	?
23.819-B	Spare filter, 4 pieces	?
23.819-C	Air hose, 2 metres	?



MSA	Size	Kg
23.812	320 x 300 x 250 mm	3.000

Working cabinet for micromotors.
 A removable drawer makes it easy to collect the residues of the precious alloys used.
 The fitting with hose allows the connection of the portable vacuum cleaners MSA23.810 and MSA23.811.
 Excellent working visibility, sealed Plexiglas cabinet.



MSA	Size	Kg
23.813	600 x 400 x 400 mm	15.000

Safety cabinet for finishing work with micromotors.
 This device is equipped with several side entrances on the left and right, a neon light, a fast-air connector and a power supply for the portable vacuum cleaners MSA23.810 and MSA23.811.
 - Bright and wide working area
 - Easy-to-clean heavy-duty grid collector
 - Solid and reliable construction.

24



BENCHES AND CABINETS

24 - 2

CHAIRS AND STOOL

24 - 10

ACCESSORIES FOR BENCHES

24 - 15

Solid oak benches.

HOROTEC® DELUXE solid oak benches, very stable and well adapted to watchmakers.

- Top 140 x 72 cm, adjustable working height by an electrical system from 95 to 115 cm
- Ergonomic and adjustable Alcantara oval armrests in any desired position
- With cabinet (1 or 2) or without. The cabinet contains 1 tray and 4 drawers (3 of them with adaptable separations). Different keys for locking each cabinet
- Technical channel
- Stability adjustment made by screws underneath each polyamide foot.



ADJUSTABLE DELUXE VERSION



30.5 x 41.5 x 62.5 mm

MSA24.446

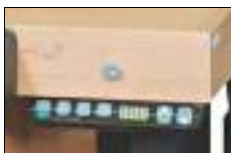

Electrical adjustment :

MSA	Versions	Cabinet	Kg
24.442	A	0	80.000
24.443	B	1	112.000
24.446	C	2	144.000

VERSION A :

- 1 top 140 x 72 cm, height adjustable 95...115 cm
- 2 ergonomic and adjustable Alcantara oval armrests
- 1 technical channel
- Without cabinet.

VERSION B :

- Version A + 1 right cabinet.

VERSION C :

- Version A + 2 cabinets.

Inside dimensions of the cabinet :

- 1 tray 24 x 33.6 cm
- 2 drawers 24 x 37.5 x 6 cm (15 cases)
- 1 drawer 24 x 37.5 x 10 cm (15 cases)
- 1 drawer 24 x 37.5 x 10 cm.

Separations are removable.

Laboratory benches.

HOROTEC® white laboratory benches, modern and ergonomic. Its conception has been designed to offer a very comfortable working place.

- Top 140 x 72 cm (adjustable working height by screws and nuts from 85 to 115 cm) and 1 rear panel
- Ergonomic and adjustable Alcantara oval armrests
- With cabinet (1 or 2) or without. The cabinet contains 1 tray and 4 drawers
- Different keys for locking each cabinet
- Stability adjustment made by screws underneath each polyamide foot.



**ADJUSTABLE
LABORATORY
VERSION**



MSA	Colour	Top	Cabinet	Kg
24.601	White	140 x 72 cm	0	-
24.602	White	140 x 72 cm	1	-
24.603	White	140 x 72 cm	2	-

HOROTEC® white laboratory benches, modern and ergonomic. They meet all requirements and offer optimal comfort.

- Top 140 x 72 cm (adjustable working height by an electrical system from 95 to 123 cm) and 1 rear panel
- Ergonomic and adjustable Alcantara oval armrests
- With cabinet (1 or 2) or without. The cabinet contains 1 tray and 4 drawers
- Different keys for locking each cabinet
- Stability adjustment made by screws underneath each polyamide foot.



**ELECTRIC
ADJUSTMENT
LABORATORY
VERSION**



MSA	Colour	Top	Cabinet	Kg
24.621	White	140 x 72 cm	0	-
24.622	White	140 x 72 cm	1	-
24.623	White	140 x 72 cm	2	-

Standard benches.

HOROTEC® standard benches, very stable and well adapted to watchmakers.

- Top 140 x 70 cm, adjustable working height by a manual or electrical hydraulic system from 95 to 115 cm
- Fixed armrests and 1 central drawer
- With cabinet (1 or 2) or without. The cabinet contains 1 tray and 4 drawers (3 of them with adaptable separations). Different keys for locking each cabinet
- 1 technical channel
- Stability adjustment made by screws underneath each polyamide foot.



ADJUSTABLE STANDARD VERSION



MSA24.508-140



MSA24.568-140



P. 24-5



MSA24.573-140



Manual hydraulic adjustment :

MSA	Versions	Colour	Kg
24.504-140	A	Standard	102.000
24.564-140	A	Grey	102.000
24.569-140	A	White	102.000
24.505-140	B	Standard	134.000
24.565-140	B	Grey	134.000
24.570-140	B	White	134.000

VERSION A :

- 1 top 140 x 70 cm, height adjustable 95...115 cm
- 2 fixed armrests and 1 central drawer
- 1 technical channel
- Without cabinet.

VERSION B :

- Version A + 1 right cabinet.

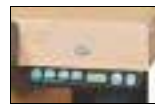

Electrical adjustment :

MSA	Versions	Colour	Kg
24.506-140	C	Standard	102.000
24.566-140	C	Grey	102.000
24.571-140	C	White	102.000
24.507-140	D	Standard	134.000
24.567-140	D	Grey	134.000
24.572-140	D	White	134.000
24.508-140	E	Standard	166.000
24.568-140	E	Grey	166.000
24.573-140	E	White	166.000

VERSION C :

- 1 top 140 x 70 cm, height adjustable 95...115 cm
- 2 fixed armrests and 1 central drawer
- 1 technical channel
- Without cabinet.

VERSION D :

- Version C + 1 right cabinet.

VERSION E :

- Version C + 2 cabinets.

HOROTEC® standard benches, very stable and well adapted to watchmakers.

- Top 140 x 70 cm, adjustable working height by screws and nuts
- Fixed armrests, 1 central drawer and 1 rear panel
- With cabinet (1 or 2) or without. The cabinet contains 1 tray and 4 drawers (3 of them with adaptable separations)
- Different keys for locking each cabinet
- Stability adjustment made by screws underneath each polyamide foot.



ADJUSTABLE STANDARD VERSION



MSA	Versions	Colour	Top	Cabinet	Kg
24.501-140	A	Standard	140 x 70 cm	0	75.000
24.561-140	A	Grey	140 x 70 cm	0	75.000
24.575-140	A	White	140 x 70 cm	0	75.000
24.502-140	B	Standard	140 x 70 cm	1	107.000
24.562-140	B	Grey	140 x 70 cm	1	107.000
24.576-140	B	White	140 x 70 cm	1	107.000
24.503-140	C	Standard	140 x 70 cm	2	140.000
24.563-140	C	Grey	140 x 70 cm	2	140.000
24.577-140	C	White	140 x 70 cm	2	140.000

VERSION A :

- 1 top 140 x 70 cm, adjustable working height by screws and nuts
- 2 fixed armrests and 1 central drawer
- 1 rear panel
- Without cabinet.

Optional : technical channel MSA24.528-140V4.

VERSION B :

- Version A + 1 right cabinet.

VERSION C :

- Version A + 2 cabinets.

For export, the bench is delivered unassembled in a cardboard transport box (included in the price) with detailed assembly instructions. Box size : 150 x 95 x 55 cm.

BENCHES AND CABINETS

- HOROTEC® standard and compact bench, specially designed to offer a very comfortable workplace and a reduced footprint.
- Top 122 x 60 cm (adjustable working height by screws and nuts from 85 to 115 cm) and 1 rear panel
 - Fixed armrests
 - With 1 cabinet containing 1 tray and 2 drawers (delivered with 1 key)
 - Stability adjustment made by screws underneath each polyamide foot.



ADJUSTABLE COMPACT VERSION



MSA	Colour	Top	Cabinet	Kg
24.480	Standard	122 x 60 cm	1	76.500

Mini bench.

Mini bench HOROTEC®.

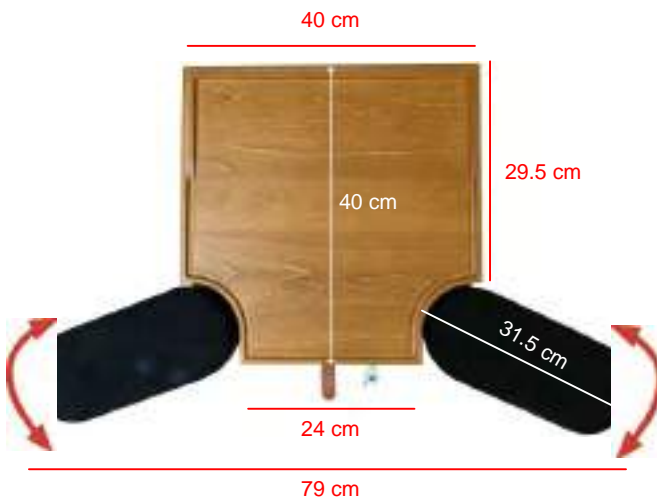

MSA	Height	Kg
24.071	13.5 cm	9.300

Mini bench.

- Solid oak top and adjustable Alcantara armrests
- Adjustable feet for perfect stability
- Drawer on front side, delivered with 1 key
- Possibility to store the armrests inside the bench.

Specially studied and designed to obtain a good working height on a standard furniture (table, desk, etc.).

The height-gain, which allows this mini bench, offers a wide range of applications. It replaces a traditional bench in places with reduced space : stand during an exhibition, a store, a meeting room, homeworking, training, etc.

Armrests.



MSA	Kg
24.472	-

Pair of ergonomic armrests, with 1 pair of mechanical articulated arms and 2 oval armrests in Alcantara.

Cabinets.

Cabinets for HOROTEC® benches.



MSA	Size W x D x H	Kg
24.460	30.5 x 59.5 x 63 cm (wheels included)	32.400

Mobile watchmaker cabinet, mounted on 4 pivoting wheels (1-wheel brake). Top covered with a black rubber groove mat, 4 drawers and 1 tray with full opening.



Inside dimensions of the cabinet :
 - 1 tray 23.8 x 53 cm
 - 2 drawers 21.8 x 53 x 6 cm (21 cases 7 x 7 x 6 cm)
 - 1 drawer 21.8 x 53 x 10 cm (21 cases 7 x 7 x 6 cm),
 - 1 drawer 21.8 x 53 x 13 cm.

Separations are removable.

The classic cabinet for the HOROTEC® standard benches.



MSA	Size	Kg
24.434	75.0 x 48.7 x 78.7 cm	46.800

Bench mobile cabinet with 4 pivoting wheels (2 wheels brake). Top covered with a black rubber groove mat, 5 drawers with full opening.

Inside dimensions of the cabinet :
 - 3 drawers 39 x 54.9 x 6.5 cm
 - 1 drawer 39 x 54.9 x 7.9 cm
 - 1 drawer 39 x 54.9 x 17.9 cm.



MSA	Size	Kg
24.040	70 x 30 x 25 cm	8.260

Cabinet made of spruce with 22 drawers.

Chairs.

HOROTEC® chairs.

HOROTEC



MSA	Sitting height	Base	Kg
24.002	41...54 cm	Wheels	12.000

Watchmakers chair.

- 5 arm base with braked wheels (stopped when unloaded)
- Gas filled lift cylinder with fingertip adjustment for seat height
- Tilt adjustment asynchronous of the seat and the backrest by a single lever
- Ergonomic seat with double curve in multi-ply varnished beech, 40.5 x 39 cm
- Articulated backrest in varnished beech 40 x 22 cm, adjustable in height.

Spare parts :

MSA	Item	Kg
24.002-01	Low black column, setting 41... 54 cm	1.280
24.002-02	Set of 5 braked wheels (stopped when unloaded)	0.535
24.002-03	High black column, setting 51... 75 cm	1.740
24.002-04	Set of 5 buffers	0.188
24.002-05	Aluminium monobloc foot-ring	5.500
24.002-06	Set of 5 casters stopped when loaded	0.535
24.002-07	Zinc-plated knurled wheel for asynchronous plates	0.035

HOROTEC



MSA	Sitting height	Base	Kg
24.010	46...59 cm	Wheels	10.000

Watchmakers chair.

- 5 arm base with braked wheels (stopped when unloaded)
- Gas filled lift cylinder with fingertip adjustment for seat height
- Tilt adjustment asynchronous of the seat and the backrest by a single lever
- Comfortable seat made of black polyurethane soft foam, 40 x 39 cm
- Articulated backrest made of black polyurethane soft foam 40 x 22 cm, adjustable in height.

Spare parts :

MSA	Item	Kg
24.002-01	Low black column, setting 41... 54 cm	1.280
24.002-02	Set of 5 braked wheels (stopped when unloaded)	0.535
24.002-03	High black column, setting 51... 75 cm	1.740
24.002-04	Set of 5 buffers	0.188
24.002-05	Aluminium monobloc foot-ring	5.500
24.002-06	Set of 5 casters stopped when loaded	0.535
24.002-07	Zinc-plated knurled wheel for asynchronous plates	0.035



MSA	Sitting height	Base	Kg
24.061	41...54 cm	Wheels	10.600

- Watchmakers chair.
- 5 arm base with braked wheels (stopped when unloaded)
 - Gas filled lift cylinder with fingertip adjustment for seat height
 - Tilt adjustment asynchronous of the seat and the backrest by a single lever
 - Ergonomic seat with double curve in multi-ply varnished beech, 40,5 x 39 cm
 - Articulated backrest in varnished beech 39 x 38 cm, adjustable in height.



MSA	Sitting height	Base	Kg
24.020	51...75 cm	Buffers	14.000

- Watchmakers chair made of polyurethane (PUR) with buffers and foot-ring.
- Seat 40 x 39 cm
 - Backrest 35 x 22 cm.



MSA	Sitting height	Base	Kg
24.021	51...75 cm	Buffers	11.000

- Watchmakers chair made of wood with buffers and foot-ring.
- Seat 40,5 x 39 cm
 - Backrest 40 x 22 cm.

Other chairs.



MSA	Sitting height	Base	Kg
24.031	42...56 cm	Wheels	10.200
24.033	44...64 cm	Wheels	10.200
24.037	55...80 cm	Buffers	10.200

TEC BASIC watchmakers chair made of black polyurethane foam.
 - 5 arm base with braked wheels or buffers for hard floor
 - Gas filled lift cylinder with fingertip adjustment for seat height
 - Adjustable backrest in height and depth.

Spare parts :

MSA	Item	Kg
24.032-R	Set of 5 wheels for hard floor	0.535
24.032-S	Buffer for hard floor	0.040



MSA	Sitting height	Base	Kg
24.025	42...53 cm	Wheels	12.200
24.027	45...65 cm	Wheels	12.200
24.029	55...80 cm	Buffers	12.200

TEC BASIC watchmakers chair made of black polyurethane foam.
 - 5 arm base with braked wheels or buffers for hard floor
 - Adjustable circular foot-ring
 - Gas filled lift cylinder with fingertip adjustment for seat height
 - Adjustable backrest in height and depth.

Spare parts :

MSA	Item	Kg
24.032-R	Set of 5 wheels for hard floor	0.535
24.032-S	Buffer for hard floor	0.040



CHAIRS AND STOOL

Excellent design quality meets superb ergonomics and special comfort.
 Neon represents the new generation of work chairs. No other production work chair has features that can compare.
 Thanks to its innovative 1+1 system, the upholstery can be changed with just one click.
 This means the Neon is flexible, sustainable and optically adaptable for the workplace.



MSA		Flex strip	Upholstery	Kg
24.065-0110	(1)	Orange	● Fabric Duotec	10.600
24.065-0111	(1)	Orange	● Fabric Duotec	10.600
24.065-0112	(1)	Orange	● Fabric Duotec	10.600
24.065-0113	(1)	Orange	● Artificial leather	10.600
24.065-0114	(1)	Orange	● Artificial leather	10.600
24.065-0115	(1)	Orange	● Artificial leather	10.600
24.065-0116	(1)	Orange	● Integral foam	10.600
24.065-0117	(1)	Orange	● Integral foam	10.600
24.065-0118	(1)	Orange	● Integral foam	10.600
24.065-0119	(1)	Orange	● Supertec	10.600
24.065-0120	(1)	Orange	● Supertec	10.600
24.065-0121	(1)	Orange	● Supertec	10.600
24.065-0210	(2)	Green	● Fabric Duotec	10.600
24.065-0211	(2)	Green	● Fabric Duotec	10.600
24.065-0212	(2)	Green	● Fabric Duotec	10.600
24.065-0213	(2)	Green	● Artificial leather	10.600
24.065-0214	(2)	Green	● Artificial leather	10.600
24.065-0215	(2)	Green	● Artificial leather	10.600
24.065-0216	(2)	Green	● Integral foam	10.600
24.065-0217	(2)	Green	● Integral foam	10.600
24.065-0218	(2)	Green	● Integral foam	10.600
24.065-0219	(2)	Green	● Supertec	10.600
24.065-0220	(2)	Green	● Supertec	10.600
24.065-0221	(2)	Green	● Supertec	10.600

MSA		Flex strip	Upholstery	Kg
24.065-0310	(3)	Blue	● Fabric Duotec	10.600
24.065-0311	(3)	Blue	● Fabric Duotec	10.600
24.065-0312	(3)	Blue	● Fabric Duotec	10.600
24.065-0313	(3)	Blue	● Artificial leather	10.600
24.065-0314	(3)	Blue	● Artificial leather	10.600
24.065-0315	(3)	Blue	● Artificial leather	10.600
24.065-0316	(3)	Blue	● Integral foam	10.600
24.065-0317	(3)	Blue	● Integral foam	10.600
24.065-0318	(3)	Blue	● Integral foam	10.600
24.065-0319	(3)	Blue	● Supertec	10.600
24.065-0320	(3)	Blue	● Supertec	10.600
24.065-0321	(3)	Blue	● Supertec	10.600
24.065-0410	(4)	Grey	● Fabric Duotec	10.600
24.065-0411	(4)	Grey	● Fabric Duotec	10.600
24.065-0412	(4)	Grey	● Fabric Duotec	10.600
24.065-0413	(4)	Grey	● Artificial leather	10.600
24.065-0414	(4)	Grey	● Artificial leather	10.600
24.065-0415	(4)	Grey	● Artificial leather	10.600
24.065-0416	(4)	Grey	● Integral foam	10.600
24.065-0417	(4)	Grey	● Integral foam	10.600
24.065-0418	(4)	Grey	● Integral foam	10.600
24.065-0419	(4)	Grey	● Supertec	10.600
24.065-0420	(4)	Grey	● Supertec	10.600
24.065-0421	(4)	Grey	● Supertec	10.600

BIMOS work chair type Neon 2 on load-dependant braked double wheels.

- Seat height 45...62 cm
- Permanent contact backrest (-2...19°). Height 57 cm
- Ergonomic package with tension settings, seat depth, seat tilt and backrest height
- Self-supporting and secure pneumatic cylinder with protection cover
- Black aluminium base with 5 arms with load-dependant braked double wheels.

Stool.**HOROTEC® stool.**

MSA	Sitting height	Base	Kg
24.060	55...79 cm	Wheels	7.500

Wooden stool.

- 5 arm black polyamide base with braked wheels (stopped when unloaded)
- Gas filled lift cylinder with fingertip adjustment for seat height
- Shock absorber
- Round seat in multi-ply varnished beech, thickness 19.5 mm.

Spare parts :

MSA	Item	Kg
24.060-01	Low column, height adjustment 40...53 cm	1.148
24.060-02	High column, height adjustment 55...79 cm	1.198

Footrests.



MSA	Size	Kg
24.038	450 x 350 mm	1.450

Adjustable ESD footrest, ground cable 10 mm and eyelet Ø 4 mm.
 - Sturdy metal construction. Colour : black
 - Supports ergonomic seating comfort
 - ECOSTAT® anti-slip coating, rubber Feet
 - Adjustable height and inclination.



MSA	Size	Kg
24.057	440 x 340 mm	-

Footrest with gas spring. Non-slip rubber mat.
 Adjustable tilt range between 8° and 25°.
 Height adjustment from 100 to 340 mm.

Vices and bases.



MSA	Size	Maximal opening	Kg
24.113	70 x 95 mm	60 mm	0.565

Grey bench clamp for vice fixing.
 Compatible with vice MSA08.104.
 Delivered without fixing brass plate.

Vices : see chapter 08.



MSA	Size	Kg
24.405	60 x 60 x 50 mm	0.150

Wooden vice base.
Easy mounting on a bench thanks to a screw fitted with a detachable handle.
Compatible with vice MSA08.104.
Delivered without fixing brass plate.

Vices : see chapter 08.

Accessory :

MSA	Item	Kg
24.405-01	Metal insert M6	0.008



MSA	Kg
24.401	1.360

Steel support with 1 vice and 1 peg stick.



MSA	Size	Kg
24.410	205 x 55 x 27 mm	0.150

Peg stick.

C-Frames.



MSA	Kg
24.523	0.760

Complete double swan-neck to be fixed on a bench.

Contents :

- 1 black anodized swan-neck MSA24.524
- 1 vacuum pen in black anodized aluminium MSA19.877
- 1 blower in black anodized aluminium MSA19.856
- 1 Nylon® soft brush Ø 10 mm MSA19.813
- 1 metre black pipe Ø 8 mm MSA19.851
- 1 metre black pipe Ø 6 mm MSA19.826
- 1 safety clip MSA19.862 for pipe Ø 8 mm
- 1 safety clip MSA19.861 for pipe Ø 6 mm
- 1 return spring MSA24.524-03, high tension
- 1 return spring MSA24.524-05, low tension
- 1 straight fitting Ø 6 mm MSA19.828-A
- 1 reduction 10-8 mm MSA19.849-D.



MSA	Kg
24.524	0.570

Double swan-neck alone to be fixed on a bench.

- (a) Drilling Ø : 60 mm
- (b) Thickness of the workplace : minimum 35 mm / maximum 55 mm.



MSA	Kg
24.003-01	0.187

Bench socket for fixing a lamp.

Bench mats.



MSA		Colour	Size	Kg
24.206	(1)	Black	35 x 24 cm	0.270
24.207	(2)	White	35 x 24 cm	0.270
24.208	(3)	Green	35 x 24 cm	0.270

Wrapper of 5 adherent and repositionable bench mats.
Thickness 0.5 mm.

5 pieces



MSA		Colour	Type	Size	Kg
24.213	(1)	Green	Self-adhesive	32 x 24 cm	0.190
24.214	(2)	Green	Anti-skid	32 x 24 cm	0.195
24.215	(3)	Black	-	32 x 24 cm	0.195

Wrapper of 1 soft and flexible bench mat.
Resists to solvents, benzine, alcohol, etc. (except acetone).

(1) Thickness 1.50 mm
(2+3) Thickness 2.00 mm

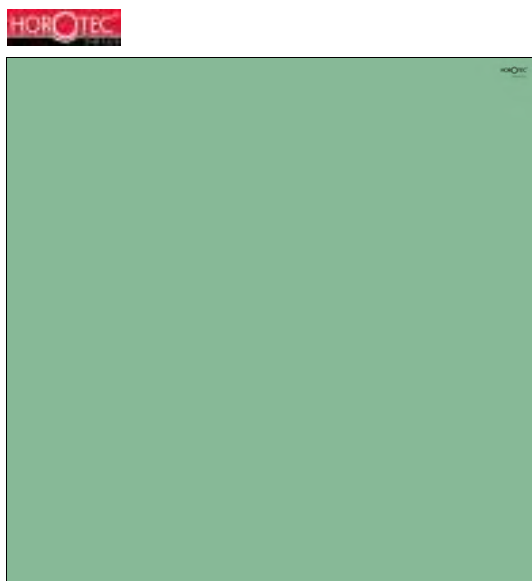

MSA	Colour	Type	Size	Kg
24.216	Green	Anti-skid	100 x 100 cm	1.400

Soft and flexible bench mat.
Resists to solvents, benzine, alcohol, etc. (except acetone).
Thickness 2.00 mm.

Size : 1 meter x 1 meter

ACCESSORIES FOR BENCHES



MSA	Size	Kg
24.203	35 x 24 cm	0.140

Soft anti-skid green bench mat, no self-adhesive but soft enough to be very adherent.

Thickness 2 mm.



MSA	Hardness	Size	Kg
24.224	40 Shore	29.5 x 21 cm	0.240

Opaque soft silicone sheet.

Thickness 3 mm.



MSA	Hardness	Size	Kg
24.225	70 Shore	29.5 x 21 cm	0.250

Transparent hard silicone sheet.

Thickness 3 mm.



MSA	Size	Kg
24.210	20 x 3.5 cm	0.010
24.211	30 x 3.5 cm	0.015

Self-adhesive PVC band to stick on bench, for winding watches.

Ridged trays.



MSA	Size	Kg
24.220	15 x 10 cm	0.046
24.221	30 x 18 cm	0.160

Self-adhesive ridged tray to avoid tools rolling.



MSA	Size	Kg
24.222 (1)	15.3 x 10 cm	0.070
24.223	25.7 x 15 cm	0.176

Black silicone anti-slip tray with grooves.

- (1) with 19 grooves
- (2) with 32 grooves

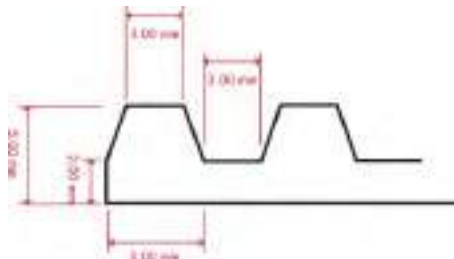

PVC blanket.



MSA	Size	Kg
24.205	100 x 135 cm	0.385

PVC silvered blanket for bench cover to protect tools and parts from dust.
Sold by metre.
Thickness 0.25 mm.

26



POLISHING / ABRASIVES

26 - 2

PROTECTIONS

26 - 18

CLEANING

26 - 26

SOLUTIONS

26 - 37

LUMINOUS PIGMENTS

26 - 45

OTHER ARTICLES

26 - 46

GLUES / ADHESIVES

26 - 48

Polishing device tripod.



MSA	Kg
26.184	0.085

The tripod polishing device is a specialized tool for polishing watch components.

The removable brass support holds any type of component.

The 2 adjustment screws guarantee optimal flatness.

For use with a zinc plate and an abrasive.

Spare part :

MSA	Item	Kg
26.184-A	Brass support for polishing device tripod	?



Polishind compounds.



ASSORTMENT LUXOR® (1) (2) (3) (4) (5) (6)

MSA	Kg	Assortment of 7 polishing compounds LUXOR® allowing to obtain clean pieces, to decrease working time and the consumption.
26.014	0.950	

MSA	Grit	Colour	Material	Operation	Support	Size	Kg
26.019 (1)	0.1 µ	Orange	Fragile precious metals	Optimal shinning (allows to replace the American red)	Buffing cotton disc and wheel with cotton plates	Ø 30 x 80 mm	0.110
26.021 (3)	0.3 µ	White	Platinum Grey/white gold Stainless steel - Silver	Finishing + polishing of diamond gold pieces	Buffing cotton disc and wheel with cotton plates	Ø 30 x 80 mm	0.100
26.020 (2)	0.5 µ	Yellow	Yellow and pink gold	Finishing	Buffing cotton disc and wheel with cotton plates	Ø 30 x 80 mm	0.103
26.018 (4)	1.0 µ	Blue	Non-ferrous (brass type)	Finishing	Buffing cotton disc	Ø 30 x 80 mm	0.118
26.017 (5)	1.0 µ	Grey	Platinum	Preparation	Polishing cotton disc and wheel with cotton plates	Ø 30 x 80 mm	0.131
26.016 (6)	3.0 µ	Green	All metals	Preparation (middle defects)	Polishing cotton disc and wheel with cotton plates	Ø 30 x 80 mm	0.111
26.015 (7)	6.5 µ	Pink	All metals	Preparation (large defects)	Polishing cotton felt/disc and wheel with cotton plates	Ø 30 x 80 mm	0.107

Polishing compound LUXOR®. See assortment MSA26.014.



MSA	Type	Colour	Operation	Kg
26.030-10	S10	Mauve	Preparation	0.100
26.030-20	S20	Yellow	Polishing	0.100
26.030-30	S30	Red	Finishing	0.100

Polishing compound EXTREM for preparation, polishing and finishing of :

- Ferrous metals : stainless steel
- Precious metals : platinum and white gold
- High hardness : technical ceramics, art ceramics, porcelain and Hyceram®
- Hard stones : malachite, aquamarine, agate, topaz, turquoise, etc.

Polishing compounds for titanium.



MSA	Type	Operation	Size	Kg
26.026	(1) HRA 17	Preparation (greasy)	Ø 40 x 220 mm	0.500
26.027	(2) HRA 171	Medium preparation (dry)	Ø 40 x 220 mm	0.500
26.028	(3) HRA 20	Fine polishing (dry)	Ø 40 x 220 mm	0.500
26.029	(4) HRA 30	Super-finishing polishing (dry)	Ø 40 x 220 mm	0.500

Polishing compound for preparation and polishing of titanium.

DIALUX polishing compounds.



MSA	Size	Kg
26.560	100 x 33 x 30 mm	0.114

DIALUX BLUE polishing compound for use with brushes or cotton, felt or flannel discs.
Super finishing for all metals.



MSA	Size	Kg
26.561	100 x 33 x 30 mm	0.115

DIALUX WHITE polishing compound for use with brushes or cotton, felt or flannel discs.
Shining and fine buffing of all metals.



MSA	Size	Kg
26.562	100 x 33 x 30 mm	0.120

DIALUX GREY polishing compound for use with brushes or cotton, felt or flannel discs.
Stainless steel buffing.



MSA	Size	Kg
26.563	100 x 33 x 30 mm	0.117

DIALUX YELLOW polishing compound for use with brushes or cotton, felt or flannel discs.
Polishing and buffing of tender metals (copper, bronze, zamak, aluminium alloys, etc.) and plastic materials or coatings.



MSA	Size	Kg
26.564	100 x 33 x 30 mm	0.149

DIALUX RED polishing compound for use with brushes or cotton, felt or flannel discs.
Fine buffing for gold and silver.



MSA	Size	Kg
26.565	100 x 33 x 30 mm	0.140

DIALUX GREEN polishing compound for use with brushes or cotton, felt or flannel discs.
Fine buffing of special steels, very hard alloys (chrome, cobalt chrome, titanium, etc.).



MSA	Size	Kg
26.566	100 x 33 x 30 mm	0.153

DIALUX VORNEX polishing compound for use with brushes or cotton, felt or flannel discs. Brushing or pre-polishing erases any scratches or scrapes from current metals. This compound doesn't leave a shiny surface. For finishing use a buffing compound.
Brushing or pre-polishing clears the scratches or stripes of all common metals.



MSA	Size	Kg
26.567	100 x 33 x 30 mm	0.095

DIALUX BLACK polishing compound for use with brushes or cotton, felt or flannel discs.
Super finishing of silver.

POLYWATCH® polishing compounds.



MSA	Packaging	Size	Kg
26.552-2	Tube of 5 g	Ø 20 x 80 mm	0.007

POLYWATCH® polishing paste for scraped plastic watch glasses. Simply apply the paste to the surface and rub away the scratches with a cloth.



MSA	Contents	Packaging size	Kg
26.499	2x 0.5 g	90 x 12 x 195 mm	0.036

Polishing paste POLYWATCH®.
High-Performance Diamond Polish for watch mineral crystals.
- Removes fine, light and medium deep scratches
- 2-Component-System :

Step 1 - removing the scratches with REPAIR 1
Step 2 - polishing on high gloss with FINISH 2

- Professional results thanks to the "Diamond-Polishing-Technology" (DPT)
- Easy and effective application
- Repair instead of replacing
- For approx. 30 to 40 applications.

Contents :
- 1x REPAIR 1 (0.5 g)
- 1x FINISH 2 (0.5 g)
- 1x polishing rod
- 2x 6 polishing strips.

Polishing compound for scrystals.



MSA	Size	Kg
26.550	130 x 30 x 30 mm	0.140

Polishing compound for scraped plastic watch crystals.

Diamond powders and pastes.



MSA	Type	Size	Kg
26.575	10 carats	Ø 17 x 61.5 mm	0.005
26.575-20	20 carats	Ø 17 x 61.5 mm	0.005
26.575-50	50 carats	Ø 17 x 61.5 mm	0.005
26.575-100	100 carats	Ø 17 x 61.5 mm	0.005

DIADUST® diamond powder, calibre quality PM (standard 0-2). DIADUST® micron diamond powder is produced from natural diamond. DIADUST® is preferred in some applications requiring very free cutting properties, as well as for the production of some electrometallic tools and wheels. PM is also used in some polishing applications, for diamond cutting and the fine polishing of diamond drawing dies.



MSA	Type	Packaging	Size	Kg
26.576	1.103	Syringe of 10 g	Ø 35 x 190 mm	0.085
26.577	1.105	Syringe of 10 g	Ø 35 x 190 mm	0.085
26.578	3.103	Syringe of 10 g	Ø 35 x 190 mm	0.085
26.579	3.105	Syringe of 10 g	Ø 35 x 190 mm	0.085

BIODIAMANT® paste. Abrasive diamond compound only containing pure diamond powder without impurities, soluble in water. Paste recommended for finishing operations and super optic polishing. The end result is a brilliant shine with a polished aspect.

Explanation of types :
 1.103 : granulous = 1 µ ; concentration : strong
 1.105 : granulous = 1 µ ; concentration : extra-strong
 3.103 : granulous = 3 µ ; concentration : strong
 3.105 : granulous = 3 µ ; concentration : extra-strong

Diamantine.



MSA	Type	Packaging	Kg
26.573	Fine PA 2.50 - 10 µ	Box of 30 cc	0.060
26.570	Fine PA 2.50 - 10 µ	Bag of 1 Kg	1.000
-	-	-	-
26.572	Medium XE6 4 - 19 µ	Box of 30 cc	0.060
26.571	Medium XE6 4 - 19 µ	Bag of 1 Kg	1.000

Diamantine. Top quality polishing powder, ideal to get finer surfaces.



MSA	Size	Kg
26.581	Ø 65 x 35 mm	0.077

Diamantine box made of water resist birch tree wood. The base has a polished steel plate Ø 45 mm and is stackable in view to keep different sorts of diamantine on each plate that can be used several times.

Spare part :

MSA	Item	Kg
26.581-B	Base, Ø 65 x 20 mm	0.048
26.581-C	Lid, Ø 65 x 20 mm	0.029



MSA	Size	Kg
26.180	120 x 40 x 20 mm	0.940

Zinc plate.
Delivered in 1 wooden box.

Bees wax.



MSA	Kg
26.183	0.050

Bees wax in cone shape.

Scraper and scratch brush.



MSA	Size	Kg
26.170	90 x 10 mm	0.025

Complete scraper :
- 1 scraper handle with tightening screw
- 1 3-sided tapered and reversible blade.

Spare parts :

MSA	Item	Kg
26.170-A	(1) Triangular blade	0.004
26.170-B	Scraper handle	0.021





MSA	Size	Kg
26.152	Ø 8 x 135 mm	0.011

Scratch brush, pen shape with glass fibre Ø 2 mm bristles.

Spare part :

MSA	Item	Kg
26.153	Refill, Ø 2 x 110 mm Pouch of 12 pieces, 135 x 30 x 6 mm	0.009



MSA	Size	Kg
26.150	Ø 12 x 120 mm	0.012

Scratch brush, pen shaped with glass fibre Ø 4 mm bristles.

Spare part :

MSA	Item	Kg
26.151	Refill, Ø 4 x 40 mm Box of 24 pieces, 65 x 50 x 12 mm	0.034



MSA	Ø	Length	Kg
26.165	8 mm	180 mm	0.030
26.166	15 mm	180 mm	0.060
26.167	20 mm	180 mm	0.100
26.168	25 mm	180 mm	0.150
26.169	30 mm	180 mm	0.225

Glass fibre brush wrapped in cotton rope.



MSA	Size	Kg
26.154	Ø 12 x 120 mm	0.013

Scratch brush, pen shaped with brass fibre bristles Ø 4 mm.

Spare part :

MSA	Item	Kg
26.155	Refill, Ø 4 x 40 mm Box of 24 pieces, 60 x 40 x 15 mm	0.036



MSA	Size	Kg
26.172	Ø 12 x 120 mm	0.013

Scratch brush, pen shaped with NYLON® fibre Ø 4 mm bristles.

Spare part :

MSA	Item	Kg
26.173	Refill, Ø 4 x 40 mm Box of 24 pieces, 65 x 50 x 12 mm	0.016



MSA	Size	Kg
26.160	60 x 27 mm	0.012

Large brass wire scratch brush.

White leather buff sticks for cleaning or polishing.
Also used for closing thin and delicate watch case backs by hand pressure.



MSA	Width	Length	Kg
26.422	6 mm	215 mm	0.004

White leather buff stick.



MSA	Width	Length	Kg
26.423	6 mm	110 mm	0.001

Plastic protection cover for MSA26.422.
Sold separately.



MSA	Width	Length	Kg
26.420	12 mm	215 mm	0.008

White leather buff stick.



MSA	Width	Length	Kg
26.421	12 mm	110 mm	0.002

Plastic protection cover for MSA26.420.
Sold separately.



MSA	Width	Length	Kg
26.424	22 mm	245 mm	0.020

White leather buff stick.



MSA	Width	Length	Kg
26.425	22 mm	110 mm	0.002

Plastic protection cover for MSA26.424.

Emery buff sticks used for cleaning and polishing.
Delivered in different grits from coarse (150) to fine (2000).



MSA	Grit	Length	Size	Kg
26.405-150	150	290 mm	6 x 6 x 6 mm	0.004
26.405-240	240	290 mm	6 x 6 x 6 mm	0.004
26.405-500	500	290 mm	6 x 6 x 6 mm	0.004
26.405-1200	1200	290 mm	6 x 6 x 6 mm	0.004
26.405-2000	2000	290 mm	6 x 6 x 6 mm	0.004
-	-	-	-	-
26.404-150	150	290 mm	8 x 8 x 8 mm	0.006
26.404-180	180	290 mm	8 x 8 x 8 mm	0.006
26.404-240	240	290 mm	8 x 8 x 8 mm	0.006
26.404-500	500	290 mm	8 x 8 x 8 mm	0.006
26.404-1200	1200	290 mm	8 x 8 x 8 mm	0.006
26.404-2000	2000	290 mm	8 x 8 x 8 mm	0.006
-	-	-	-	-
26.403-150	150	290 mm	10 x 10 x 10 mm	0.010
26.403-240	240	290 mm	10 x 10 x 10 mm	0.010
26.403-500	500	290 mm	10 x 10 x 10 mm	0.010
26.403-1200	1200	290 mm	10 x 10 x 10 mm	0.010
26.403-2000	2000	290 mm	10 x 10 x 10 mm	0.010

Emery buff stick used for cleaning and polishing.
Triangular shape.



MSA	Grit	Length	Size	Kg
26.401-150	150	290 mm	8 x 4 mm	0.007
26.401-180	180	290 mm	8 x 4 mm	0.007
26.401-240	240	290 mm	8 x 4 mm	0.007
26.401-500	500	290 mm	8 x 4 mm	0.007
26.401-1200	1200	290 mm	8 x 4 mm	0.007
26.401-2000	2000	290 mm	8 x 4 mm	0.007
-	-	-	-	-
26.400-150	150	290 mm	20 x 6 mm	0.017
26.400-240	240	290 mm	20 x 6 mm	0.017
26.400-500	500	290 mm	20 x 6 mm	0.017
26.400-1200	1200	290 mm	20 x 6 mm	0.017
26.400-2000	2000	290 mm	20 x 6 mm	0.017

Emery buff stick used for cleaning and polishing.
Rectangular shape.



MSA	Grit	Length	Size	Kg
26.409-150	150	290 mm	5 x 2.5 mm	0.002
26.409-240	240	290 mm	5 x 2.5 mm	0.002
26.409-500	500	290 mm	5 x 2.5 mm	0.002
26.409-1200	1200	290 mm	5 x 2.5 mm	0.002
26.409-2000	2000	290 mm	5 x 2.5 mm	0.002
-	-	-	-	-
26.408-240	240	290 mm	10 x 5 mm	0.007
26.408-500	500	290 mm	10 x 5 mm	0.007
26.408-2000	2000	290 mm	10 x 5 mm	0.007

Emery buff stick used for cleaning and polishing.
Half-round shape.



MSA	Grit	Length	Size	Kg
26.406-500	500	290 mm	9 x 4 mm	0.006
26.406-1200	1200	290 mm	9 x 4 mm	0.006
26.406-2000	2000	290 mm	9 x 4 mm	0.006

Emery buff stick used for cleaning and polishing.
SAge leaf shape.

Abrasive buff sticks 3M ILF, IMFF, 213Q or 401Q used for cleaning and polishing.



MSA	Grit	Colour	Length	Size	Kg
26.428-001	1 μ	Light green	300 mm	20 x 6 mm	0.014
26.428-003	3 μ	Pink	300 mm	20 x 6 mm	0.014
26.428-005	5 μ	Brown	300 mm	20 x 6 mm	0.014
26.428-009	9 μ	Light blue	300 mm	20 x 6 mm	0.014
26.428-012	12 μ	Yellow	300 mm	20 x 6 mm	0.014
26.428-030	30 μ	Green	300 mm	20 x 6 mm	0.014

Wooden stick covered with 3M ILF abrasive paper.
Rectangular shape.



MSA	Grit	Colour	Length	Size	Kg
26.429-001	1 μ	Light green	300 mm	6 x 6 x 6 mm	0.003
26.429-003	3 μ	Pink	300 mm	6 x 6 x 6 mm	0.003
26.429-005	5 μ	Brown	300 mm	6 x 6 x 6 mm	0.003
26.429-009	9 μ	Light blue	300 mm	6 x 6 x 6 mm	0.003
26.429-012	12 μ	Yellow	300 mm	6 x 6 x 6 mm	0.003
26.429-030	30 μ	Green	300 mm	6 x 6 x 6 mm	0.003

Wooden stick covered with 3M ILF abrasive paper.
Triangular shape.



MSA	Grit	Colour	Length	Size	Kg
26.426-009	9 μ	Light blue	300 mm	20 x 6 mm	0.021
26.426-015	15 μ	Orange	300 mm	20 x 6 mm	0.021
26.426-020	20 μ	Red	300 mm	20 x 6 mm	0.021
26.426-030	30 μ	Green	300 mm	20 x 6 mm	0.021
26.426-040	40 μ	Blue	300 mm	20 x 6 mm	0.021
26.426-060	60 μ	Black	300 mm	20 x 6 mm	0.021

Wooden stick covered with 3M IMFF abrasive oriented grit paper.
Rectangular shape.



MSA	Grit	Colour	Length	Size	Kg
26.427-009	9 μ	Light blue	300 mm	6 x 6 x 6 mm	0.004
26.427-015	15 μ	Orange	300 mm	6 x 6 x 6 mm	0.004
26.427-020	20 μ	Red	300 mm	6 x 6 x 6 mm	0.004
26.427-030	30 μ	Green	300 mm	6 x 6 x 6 mm	0.004
26.427-040	40 μ	Blue	300 mm	6 x 6 x 6 mm	0.004
26.427-060	60 μ	Black	300 mm	6 x 6 x 6 mm	0.004

Wooden stick covered with 3M IMFF abrasive oriented grit paper. Triangular shape.



MSA	Grit	Colour	Length	Size	Kg
26.435-009	9 μ	Light blue	300 mm	6 x 6 x 6 mm	0.004
26.435-015	15 μ	Orange	300 mm	6 x 6 x 6 mm	0.004
26.435-020	20 μ	Red	300 mm	6 x 6 x 6 mm	0.004
26.435-030	30 μ	Green	300 mm	6 x 6 x 6 mm	0.004
26.435-040	40 μ	Blue	300 mm	6 x 6 x 6 mm	0.004
26.435-060	60 μ	Black	300 mm	6 x 6 x 6 mm	0.004

Wooden stick with 1 side covered with 3M IMFF abrasive paper. Triangular shape.



MSA	Grit	Colour	Length	Size	Kg
26.436-001	1 μ	Light green	300 mm	6 x 6 x 6 mm	0.004
26.436-003	3 μ	Pink	300 mm	6 x 6 x 6 mm	0.004
26.436-005	5 μ	Brown	300 mm	6 x 6 x 6 mm	0.004
26.436-009	9 μ	Light blue	300 mm	6 x 6 x 6 mm	0.004
26.436-012	12 μ	Yellow	300 mm	6 x 6 x 6 mm	0.004
26.436-030	30 μ	Green	300 mm	6 x 6 x 6 mm	0.004
26.436-040	40 μ	Dark blue	300 mm	6 x 6 x 6 mm	0.004

Wooden stick with 1 side covered with 3M ILF abrasive paper. Triangular shape.



MSA	Grit	Length	Size	Kg
26.437-150	P150	300 mm	6 x 6 x 6 mm	0.004
26.437-240	P240	300 mm	6 x 6 x 6 mm	0.004
26.437-320	P320	300 mm	6 x 6 x 6 mm	0.004
26.437-400	P400	300 mm	6 x 6 x 6 mm	0.004
26.437-600	P600	300 mm	6 x 6 x 6 mm	0.004
26.437-800	P800	300 mm	6 x 6 x 6 mm	0.004

Wooden stick with 1 side covered with 3M 213Q abrasive paper. Triangular shape.



MSA	Grit	Length	Size	Kg
26.438-1000	P1000	300 mm	6 x 6 x 6 mm	0.004
26.438-1200	P1200	300 mm	6 x 6 x 6 mm	0.004
26.438-1500	P1500	300 mm	6 x 6 x 6 mm	0.004
26.438-2000	P2000	300 mm	6 x 6 x 6 mm	0.004
26.438-2500	P2500	300 mm	6 x 6 x 6 mm	0.004

Wooden stick with 1 side covered with 3M 401Q abrasive paper. Triangular shape.

Wooden sticks only to be covered with different kinds of abrasive sheets.



MSA	Length	Size	Kg
26.441-2006	300 mm	20 x 6 mm	0.014

Wooden stick only, rectangular shape.



MSA	Length	Size	Kg
26.440-06	300 mm	6 x 6 x 6 mm	0.004
26.440-08	300 mm	8 x 8 x 8 mm	0.005
26.440-10	300 mm	10 x 10 x 10 mm	0.006

Wooden stick only, triangular shape.

Glass plates.



MSA	Size	Kg
26.185	300 x 250 x 10 mm	1.140
26.185-A	250 x 150 x 6 mm	0.552
26.185-B	150 x 50 x 6 mm	0.108
26.185-C	150 x 30 x 6 mm	0.066

Glass plate with bevelled and polished edges to be used as a support for abrasive papers.

Products to be used with cabrons, sheets and abrasive discs.



MSA	Volume	Kg
26.380	400 ml	0.500

Oil spray NEOVAL®.
Improves output and cut of any abrasive or polishing belts and prevents generation of heat.



MSA	Volume	Kg
26.382	400 ml	0.500

Glue spray 3M® SPRAY MOUNT to stick discs on lapidary.

Abrasive paper made of aluminium oxide or emery paper.



MSA	Grit	Colour	Size	Kg
26.299-0003	0.3 μ	White	215.9 x 279 mm	0.017
26.299-001	1 μ	Light green	215.9 x 279 mm	0.017
26.299-003	3 μ	Pink	215.9 x 279 mm	0.017
26.299-009	9 μ	Light blue	215.9 x 279 mm	0.017
26.299-012	12 μ	Yellow	215.9 x 279 mm	0.017
26.299-030	30 μ	Dark green	215.9 x 279 mm	0.017
26.299-040	40 μ	Dark blue	215.9 x 279 mm	0.017

Self-adhesive aluminium oxide abrasive sheets.
Type ILF266X.



MSA	Grit	Size	Kg
26.296-009	9 μ	230 x 280 mm	0.020
26.296-015	15 μ	230 x 280 mm	0.020
26.296-020	20 μ	230 x 280 mm	0.020
26.296-030	30 μ	230 x 280 mm	0.020
26.296-040	40 μ	230 x 280 mm	0.020
26.296-060	60 μ	230 x 280 mm	0.020
26.296-080	80 μ	230 x 280 mm	0.020
26.296-100	100 μ	230 x 280 mm	0.020

Self-adhesive aluminium oxide abrasive oriented grit sheets.
Type IMF268L.

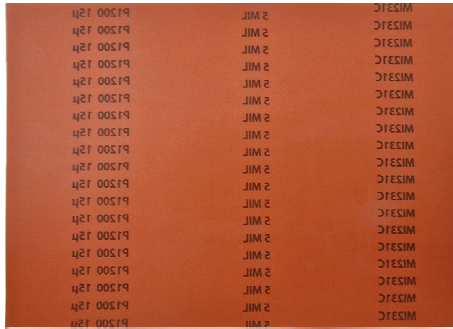

MSA	Grit	Size	Kg
26.338-015	15 µ	200 x 280 mm	0.030
26.338-020	20 µ	200 x 280 mm	0.030
26.338-030	30 µ	200 x 280 mm	0.030
26.338-050	50 µ	200 x 280 mm	0.030
26.338-060	60 µ	200 x 280 mm	0.030
26.338-080	80 µ	200 x 280 mm	0.030

Self-adhesive aluminium oxide abrasive oriented grit sheets.
Type MIRKA MI231C.



MSA	Grit	Colour	Size	Kg
26.291-003	3 µ	Pink	215.9 x 279 mm	0.010
26.291-005	5 µ	Brown	215.9 x 279 mm	0.010
26.291-009	9 µ	Light blue	215.9 x 279 mm	0.010
26.291-012	12 µ	Yellow	215.9 x 279 mm	0.010
26.291-030	30 µ	Green	215.9 x 279 mm	0.010

Aluminium oxide abrasive sheets to be used only with wooden buff sticks.
Type ILF261X.



MSA	Grit	Colour	Size	Kg
26.292-001	1 µ	Green	215.9 x 279 mm	0.007

Aluminium oxide abrasive sheets to be used only with wooden buff sticks.
Type ILF262X.



MSA	Grit	Colour	Size	Kg
26.294-009	9 µ	Light blue	230 x 280 mm	0.014
26.294-015	15 µ	Orange	230 x 280 mm	0.014
26.294-020	20 µ	Red	230 x 280 mm	0.014
26.294-030	30 µ	Green	230 x 280 mm	0.014
26.294-060	60 µ	Black	230 x 280 mm	0.014

Aluminium oxide abrasive sheets to be used only with wooden buff sticks.
Type IMF262L.



MSA	Grit	Size	Kg
26.331	40	230 x 280 mm	0.045
26.330	60	230 x 280 mm	0.045
26.329	80	230 x 280 mm	0.045
26.328	100	230 x 280 mm	0.040
26.327	120	230 x 280 mm	0.040
26.326	150	230 x 280 mm	0.035
26.325	180	230 x 280 mm	0.035
26.324	220	230 x 280 mm	0.030
26.323	240	230 x 280 mm	0.030
26.322	280	230 x 280 mm	0.030
26.321	320	230 x 280 mm	0.025
26.320	400	230 x 280 mm	0.025

Abrasive sheet of corundum cloth SIAROL 2915.



MSA	Grit	Size	Kg
26.317-060	60	230 x 280 mm	0.015
26.317-080	80	230 x 280 mm	0.015
26.317-100	100	230 x 280 mm	0.015
26.317-120	120	230 x 280 mm	0.015
26.317-150	150	230 x 280 mm	0.015
26.317-180	180	230 x 280 mm	0.015
26.317-220	220	230 x 280 mm	0.015
26.317-240	240	230 x 280 mm	0.015
26.317-280	280	230 x 280 mm	0.015
26.317-320	320	230 x 280 mm	0.015
26.317-360	360	230 x 280 mm	0.015
26.317-400	400	230 x 280 mm	0.015
26.317-500	500	230 x 280 mm	0.015
26.317-600	600	230 x 280 mm	0.015
26.317-800	800	230 x 280 mm	0.015
26.317-1000	1000	230 x 280 mm	0.015
26.317-1200	1200	230 x 280 mm	0.015
26.317-1500	1500	230 x 280 mm	0.015
26.317-2000	2000	230 x 280 mm	0.015
26.317-2500	2500	230 x 280 mm	0.015

Non adhesive abrasive sheet SIAWAT FC 1913.



MSA	Grit	Size	Kg
26.319-240	240	230 x 280 mm	0.015
26.319-280	280	230 x 280 mm	0.015
26.319-320	320	230 x 280 mm	0.015
26.319-400	400	230 x 280 mm	0.015
26.319-500	500	230 x 280 mm	0.015
26.319-600	600	230 x 280 mm	0.015
26.319-800	800	230 x 280 mm	0.015

Self-adhesive abrasive sheets SIAWAT 1913.



MSA	Grit	Size	Kg
26.333-220	220	230 x 280 mm	0.015
26.333-100	100	230 x 280 mm	0.015
26.333-320	320	230 x 280 mm	0.015
26.333-120	120	230 x 280 mm	0.015
26.333-240	240	230 x 280 mm	0.015
26.333-400	400	230 x 280 mm	0.015
26.333-500	500	230 x 280 mm	0.015
26.333-280	280	230 x 280 mm	0.015
26.333-150	150	230 x 280 mm	0.015
26.333-600	600	230 x 280 mm	0.015
26.333-180	180	230 x 280 mm	0.015
26.333-800	800	230 x 280 mm	0.015
26.333-1000	1000	230 x 280 mm	0.015
26.333-1200	1200	230 x 280 mm	0.015

Non adhesive abrasive sheet SIAWAT 1713.

Abrasive eraser blocks.



MSA	Grit	Size	Kg
26.297-30	30 Very coarse	80 x 50 x 20 mm	0.105
26.297-60	60 Coarse	80 x 50 x 20 mm	0.103
26.297-120	120 Medium	80 x 50 x 20 mm	0.103
26.297-240	240 Fine	80 x 50 x 20 mm	0.096

SCHLEIFFIX abrasive eraser block to clean, polish and shine various materials such as metal, wood, paper, paint, plastic and rubber. The abrasive grit is throughout the block and not only on the surface.

Abrasive discs.



MSA	Ø	Kg
26.361	240 mm	0.005

Intermediate abrasive disk.



MSA	Grit	Ø	Kg
26.363-1000	1000	240 mm	0.005
26.363-2500	2500	240 mm	0.005

Abrasive disc SIAWAT 1913.

Latex roll on finger cots, excellent quality. Indispensable for manipulating delicate pieces that cannot be in direct skin contact and also for protecting the fingers during polishing. Ideal for the watch, electronic, chemical and pharmaceutical industries.



MSA	Ø	Quantity	Kg
26.224	18 mm	720	0.343
26.225	20 mm	720	0.360
26.226	22 mm	720	0.460
-	-	-	-
26.231-M	18 mm	100	0.047
26.231-L	20 mm	100	0.050
26.231-XL	22 mm	100	0.055

Rolled antistatic latex pink finger cots without talc.



MSA	Quantity	Kg
26.217	1'440	0.560
26.218	1'440	0.600
26.219	1'440	0.700
26.220	1'440	0.840
-	-	-
26.227	100	0.038
26.228	100	0.040
26.229	100	0.050

Rolled latex finger cots without talc.



MSA	Quantity	Kg
26.200	1'440	0.540
26.202	1'440	0.600
26.201	1'440	0.665
-	-	-
26.210	100	0.045
26.212	100	0.047
26.211	100	0.051

Rolled latex pink finger cots with talc.



MSA	Quantity	Kg
26.244-S	720	0.330
26.244-M	720	0.343
26.244-L	720	0.360
26.244-XL	720	0.460

Rolled antistatic latex pink finger cots without talc.

Rolled finger cots in black latex.



MSA	Quantity	Kg
26.258-S	1'000	0.375
26.258-M	1'000	0.450
26.258-L	1'000	0.555
26.258-XL	1'000	0.605
-	-	-
26.268-S	100	0.040
26.268-M	100	?
26.268-L	100	0.058
26.268-XL	100	0.062

Antistatic (ESD) rolled finger cots in 100% natural black latex without powder. The black color of the fingertips makes it easier to visualize the dust. The ends are provided with rough edges to facilitate the gripping of parts. Surface resistivity of 106-108 Ω m/m².

Rolled nitrile finger cots.



MSA	Quantity	Kg
26.259-S	1'000	0.375
26.259-M	1'000	0.455
26.259-L	1'000	0.505
26.259-XL	1'000	0.640
-	-	-
26.269-S	100	0.050
26.269-M	100	0.047
26.269-L	100	0.041
26.269-XL	100	0.068

Rolled white nitrile finger cots without powder. Antistatic, chlorine and sulphur free. Ideal alternative in case of latex allergy.



MSA	Quantity	Kg
26.208-S	1'440	0.560
26.208-M	1'440	0.600
26.208-L	1'440	0.700
26.208-XL	1'440	0.840

Rolled antistatic nitrile finger cots without talc.

Finger cots distributors.



MSA	Size	Kg
26.253	600 x 174 x 206 mm	2.780

Finger cots distributor with 4 containers. Container : 142 x 130 x 136 mm.

PROTECTIONS



MSA	Size	Kg
26.254	600 x 209 x 240 mm	3.600

Finger cots distributor with 3 containers.
Container : 190 x 146 x 164 mm.

Leather fingers.



MSA	Finger	Kg
26.213	Index	0.003
26.214	Thumb	0.003

Leather finger protection with elastic hold, very comfortable.



MSA	Finger	Kg
26.236-S	Index	0.001
26.236-M	Index	0.002
26.236-L	Index	0.004
26.236-XL	Thumb	0.002

White leather finger protection, very comfortable.



MSA	Kg
26.238	0.005

Leather white finger protection with elastic, standard.



MSA	Kg
26.241-XS	0.002
26.241-S	0.002
26.241-M	0.002
26.241-L	0.002
26.241-XL	0.003

White leather and short finger protection, very comfortable.



MSA	Kg
26.242-L	0.004

Black leather and short finger protection, very comfortable.



MSA	Kg
26.243-XL	0.003

White leather and long finger protection, very comfortable.

Protection gloves.



MSA	Quantity	Packaging size	Kg
26.070-S	100	240 x 130 x 70 mm	0.080
26.070-M	100	240 x 130 x 70 mm	0.080
26.070-L	100	240 x 130 x 70 mm	0.080
26.070-XL	90	240 x 130 x 70 mm	0.080

Single-use ambidextrous gloves in white natural latex.
 - Not powdered
 - Non-sterile
 - Thickness 0.12 mm and roll up sides
 - Length 24 cm.



MSA	Quantity	Packaging size	Kg
26.143-S	100	240 x 130 x 70 mm	0.605
26.143-M	100	240 x 130 x 70 mm	0.657
26.143-L	100	240 x 130 x 70 mm	0.736
26.143-XL	90	240 x 130 x 70 mm	0.762

Single-use ambidextrous gloves in blue nitrile.
 - Not powdered
 - Non-sterile
 - Thickness 0.13 mm and roll up sides.



PAIR

MSA	Kg
26.120-01	0.021
26.120-02	0.025
26.120-03	0.026

Pair of unbleached cotton gloves.



PAIR

MSA	Kg
26.121-02	0.021

Pair of white cotton gloves.



PAIR

MSA	Colour	Kg
26.131	White	0.040
26.132	White	0.042
26.133	White	0.044

Pair of antistatic gloves in 100% nylon microfibers.
 Ideal for final inspection and handling watches or jewellery.

PROTECTIONS



MSA	Kg
26.181-M	0.026
26.181-L	0.028
26.181-XL	0.030

Pair of ambidextrous protective gloves in white cotton knit.

PAIR



MSA	Colour	Kg
26.139-S	Black	0.040
26.139-M	Black	0.042
26.139-L	Black	0.044

Pair of antistatic gloves in 100% nylon microfibers. Ideal for final inspection and handling watches or jewellery.

PAIR



MSA	Colour	Kg
26.188-S	White	0.030
26.188-M	White	0.030
26.188-L	White	0.030
26.188-XL	White	0.030
26.188-XXL	White	0.030

Pair of white NERI® seamless gloves made of 100% nylon / polyurethane.

Features :

- Polyurethane coated palm and ventilated back
- Lightweight, elastic, with excellent tactile sensitivity
- Recommended for delicate and precision operations
- Excellent abrasion and wear resistance, lint-free
- Seamless, reduces the risk of skin irritation and provides better comfort.

PAIR

Protection glasses.



MSA	Kg
26.140	0.039

Lightweight panoramic protection glasses in colourless polycarbonate, anti-blur and scratch resistant.

Sides and eyebrows protections. Length adjustable arms. Used for polishing and small welding, etc.



MSA	Kg
26.145	0.033

Lightweight panoramic protection glasses in colourless polycarbonate, anti-blur and scratch resistant.

Sides and eyebrows protections. Length adjustable and revolving arms. Used for polishing and small welding, etc.



MSA	Kg
26.187	0.045

UV protection glasses.

Worker coats.



MSA	Kg
26.237-XS	0.820
26.237-S	0.820
26.237-M	0.820
26.237-L	0.820
26.237-XL	0.820
26.237-XXL	0.820
26.237-XXXL	0.820
26.237-XXXXL	0.820

White worker coat with press buttons and revers collar :
 - 1 left chest pocket with pens location
 - 2 oblique opening side pockets
 - 65% polyester / 35% cotton.



MSA	Quantity	Kg
26.248-S	50	?
26.248-M	50	?
26.248-L	50	?
26.248-XL	50	?

Antistatic and disposable white work coat, practical with press buttons, elastic cuffs and Mao collar :
 - 40 g/m2.



MSA	Quantity	Kg
26.246-M50	50	?
26.246-L50	50	?
26.246-XL50	50	?
26.246-XXL50	50	?

Protective coat made of white breathable polypropylene fleece.
 - Shirt collar
 - Zip
 - Back length 105 cm.



MSA	A	B	Kg
26.267-XS	76-84 cm	56-64 cm	0.660
26.267-S	84-92 cm	64-72 cm	0.660
26.267-M	92-100 cm	72-80 cm	0.660
26.267-L	100-108 cm	80-88 cm	0.660
26.267-XL	108-116 cm	88-96 cm	0.660
26.267-XXL	116-124 cm	96-104 cm	0.660

White work coat for woman, antistatic ESD :

- Tailored collar
- Mounted sleeves adjustable with plastic press-buttons, 2 positions
- Central closing with 4 hidden plastic press-buttons
- 1 loop on right chest
- 1 breast pocket
- 1 4-compartment pen pocket inside the breast pocket
- 2 lower pockets
- Length 100 cm
- 99% polyester / 1% antistatic, 180g/m2.



MSA	A	Kg
26.293-S	84-92 cm	0.660
26.293-M	92-100 cm	0.660
26.293-L	100-108 cm	0.660
26.293-XL	108-116 cm	0.660
26.293-XXL	116-124 cm	0.660
26.293-XXXL	124-132 cm	0.660

White work coat for men, antistatic ESD :

- Tailored collar
- Mounted sleeves adjustable with plastic press-buttons, 2 positions
- Central closing with 4 hidden plastic press-buttons
- 1 loop on right chest
- 1 breast pocket
- 1 4-compartment pen pocket inside the breast pocket
- 2 lower pockets
- Length 100 cm
- 99% polyester / 1% antistatic, 180g/m2.

Ear plugs.



MSA	Quantity	Kg
26.144	100	0.550

3M® E-A-R synthetic ear plugs, washable, hard handle and joining string.
Individual packing in 50 pieces box dispenser.

Protective masks.



MSA	Kg
26.149	0.013

Single-use 3M® antiparticles mask, FFP1 level special non-woven, nasal padding foam, exhalation valve, nasal clamp nasal and 2 elastic ribbons.
Delivered in 1 carton with 10 pieces.

Safety tape.



MSA	Width	Length	Kg
26.240	19 mm	27.4 m	0.040

Self-adhesive green safety tape. It sticks to itself (and not to the fingers) and allows the skin to breath.
Ideal for protecting fingers during polishing or for working with sharp objects.

Clothes and skins.



MSA	Colour	Cutting	Size	Kg
26.137	Grey	Zigzag	15 x 15 cm	0.005
26.136	Grey	Sewn	35 x 30 cm	0.025

Microfiber cloth for polishing, cleaning and protecting all types of glass, precious metals, semi-precious metals and precious stones.

- Use dry or with a cleaning product
- 80% polyester and 20% polyamide
- With HOROTEC® marking.

Weight 200 g/m².



MSA	Colour	Cutting	Size	Kg
26.116	White	Sewn	35 x 30 cm	0.025
26.117	Navy blue	Sewn	35 x 30 cm	0.025
26.142	Black	Sewn	35 x 30 cm	0.025

Polishing cloth for cleaning and protecting all types of glasses, precious and semi-precious metals and precious stones.

- Use dry or with a cleaning product
- 80% polyester and 20% polyamide
- Washable at 60° C.

Grammage 200 g/m².



MSA	Colour	Size	Kg
26.113	White	30 x 30 cm	0.065

CALI microfiber cleaning cloth. It cleans and brings a shine to pearls, jewellery and precious stones.



MSA	Quantity	Size	Kg
26.685-MW	150	23 x 23 cm	?

Double mesh microfiber cleaning cloth, made of polyester and nylon. Perfectly suited to cleaning sensitive surfaces and critical areas.

Recommended for clean rooms up to class ISO5.

- 70% Polyester & 30% Nylon double knit
- Laser sealed edges
- Good absorbency
- Abrasion resistant.

Delivered in a bag of 150 pieces.

150 pieces

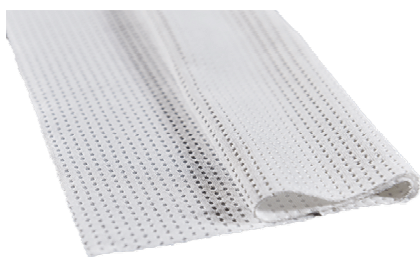

MSA	Quantity	Size	Kg
26.685-DW	100	23 x 23 cm	?

Two-layer cleaning wipe, made of polyester. Ideal for removing particles, fibres and liquids. Recommended for clean rooms up to ISO4 class.

- 100% continuous filament polyester
- Two layers laser sealed edges
- Good absorbency
- Abrasion resistant.

Delivered in a bag of 100 pieces.

100 pieces



50 pieces

MSA	Quantity	Size	Kg
26.686-PW	50	23 x 28 cm	?

Pre-impregnated cleaning wipe (iso alcohol), made of polypropylene. Ideal for removing particles, fibres, liquids and chemical residues. Recommended for clean rooms up to ISO4 class.

- 100% Melt blown Polypropylene knife-cut nonwoven
- Pre-soaked with 70% IPA (isopropyl alcohol) & 30% denoised water
- Packaged in a resealable bag with double closure preventing evaporation of the solvent.

Delivered in a bag of 50 pieces.



10 pieces

MSA	Colour	Quantity	Size	Kg
26.681	White	10	23 x 21 cm	0.118

White cloth PMX 09.50/HLD.

Delivered in a packaging with 10 pieces.



MSA	Size	Kg
26.110-A	25 x 25 cm	0.016
26.110-B	35 x 35 cm	0.031
26.110-C	43 x 35 cm	0.040

SELVYT polishing cloth in woven cotton velvet, which gives a perfect finish. Keep its efficiency after washing.



MSA	Size	Kg
26.112-A	25 x 25 cm	0.016
26.112-B	35 x 35 cm	0.031
26.112-C	43 x 35 cm	0.040

SELVYT polishing cloth in woven unbleached cotton, which gives a perfect finish.

Keep its efficiency after washing.



MSA	Size	Kg
26.109	15 x 15 cm	0.011
26.119	37 x 24 cm	0.036
26.108	55 x 37 cm	0.059

Real chamois skin cloth for cleaning.

CLEANING



MSA	Size	Kg
26.125	50 x 35 cm	0.050

Real buckskin cloth for cleaning.



MSA	Size	Kg
26.687	114 x 46 cm	?

Blue peelable mat traps 95% of particles from shoes and wheels. Mats should be placed in controlled contamination environments where traffic is frequent to prevent dirt and dust from spreading.
Sold in boxes of 8 mats of 30 sheets.

Cleaning kits.



MSA	Packaging size	Kg
26.126	90 x 75 x 7 mm	0.033

The WATCH PROTECTOR from POLYWATCH® protects the watch effectively and durably thanks to its hydrophobic coating.

- Absolutely invisible
- Reduces fingerprints, water and grease marks on treated surfaces
- Facilitates cleaning
- Dirt, dust and oil repellent (oleophobic)
- Prevents light scratches
- Versatile protection also for digital cameras, Smartwatches and Smartphones
- Exceptional durability up to 12 months.

The application of the two-component system is quick, easy and leaves no bubbles.

Step 1 : Clean the surface with the cleaning wipe, then dry with a lint-free cloth.

Step 2 : Apply the product with the pre-impregnated wipe (labelled bag SEALER).

Step 3 : After 10-15 minutes, polish the watch with the provided microfiber cloth.

Contents :

- 2 bags of wipes (Cleaner and Sealer)
- 1 microfiber cloth
- 1 pair of gloves
- 1 instruction manual.



MSA	Packaging size	Kg
26.176	140 x 240 x 55 mm	0.150

Cleaning kit for microscopes and video inspection systems.

Contents :

- Lens cleaning fluid
- Lens cleaning tissue
- Cleaning cloth
- Brush
- Air blower
- Cotton swabs.

Dust blowers.



MSA	Size	Kg
26.000	Ø 57 x 130 mm	0.080

Rubber dust blower.

Oval shape with valve and metal nozzle.

CLEANING



MSA	Size	Kg
26.005	Ø 58 x 130 mm	0.076

Blue rubber dust blower.
Oval shape with valve and protected metal nozzle.



MSA	Size	Kg
26.001	Ø 60 x 93 mm	0.067

Rubber dust blower with flat bottom.
Pear shaped with valve and metal nozzle.

Sawdust.



MSA	Grit	Packaging	Kg
26.279	Fine	Bag 10 Kg	10.000

Poplar sawdust.

Cleaning compounds.



MSA	Packaging	Size	Kg
26.054-01	1 stick	90 x 35 x 10 mm	0.039
26.054	Plate 1 Kg	300 x 250 x 10 mm	1.210

Blue compound for cleaning watch parts, mechanical parts and diverse tools such as tweezers, screwdrivers, blades, levers, etc.

Brushes.



MSA	Kg
26.158	0.015

Benzine brush with aluminium handle. White bristle.



MSA	Size	Kg
26.190	215 x 30 mm	0.020
26.159	215 x 40 mm	0.026
26.191	215 x 60 mm	0.035

Flat brush with wooden handle.



MSA	Size	Kg
26.163	100 x 30 mm	0.015

Flat brush with wooden handle. White bristle.



MSA	Size	Kg
26.162	Ø 10 x 100 mm	0.005

Extra soft double bristle brush, ideal for cleaning dials. Small grey hair.



MSA	Size	Kg
26.164	Ø 6 x 125 mm	0.003

Stencil brush.

Cleaning and polishing woods.



MSA	Length	Kg
26.250-06	80 mm	?

Pith wood sticks delivered in bundle of 6 pieces, used by watchmakers for cleaning parts.



MSA	Size	Kg
26.250-SYR	Ø 14 x 60 mm	?

Synthetic pith elder delivered in bundle of 7 pieces.



MSA	Quantity	Length	Kg
26.266	20	120 mm	0.015

Gentian polishing wood, bundle of 20 pieces.
The heart of this natural and seasonal product is used in decoration commonly in the finishing on all material, using conventional products (powders, liquids and solids, etc.).
The gentian wood is denser than the pith wood and more flexible than the boxwood.



MSA	Quantity	Size	Kg
26.255-2.0	10	Ø 2.00 x 150 mm	0.004
26.255-2.5	10	Ø 2.50 x 150 mm	0.005
26.255-3.0	10	Ø 3.00 x 150 mm	0.007
26.255-4.0	10	Ø 4.00 x 150 mm	0.013
26.255-5.0	10	Ø 5.00 x 150 mm	0.017
26.255-6.0	10	Ø 6.00 x 150 mm	0.023

Lime pegwood stick for cleaning, polishing, etc.
Delivered in bag of 10 pieces.

Sticks.



MSA	Packaging size	Kg
26.008	125 x 75 x 30 mm	0.133

Multi-purpose hand tool with aluminium anodised grey handle Ø 8 mm. Easily interchangeable screw-on accessories.

Delivered in a wooden case.

Box contents :

MSA	Item	Kg
26.008-01	Aluminium anodised grey handle, body Ø 8 mm x L 130 mm	0.017
26.008-A	PEEK stick pointed end, Ø 4.50 x L 16 mm, threading M3	0.001
26.008-B	PEEK stick bevelled end, Ø 4.50 x L 16 mm (width 4.50 mm), threading M3	0.001
26.008-C	PEEK stick hard pointed end, Ø 4.50 x L 16 mm, threading M3	0.001
26.008-D	PEEK stick bevelled end, Ø 4.50 x L 16 mm (width 2.00 mm), threading M3	0.001
26.008-E	PEEK stick bevelled end, Ø 2.90 x L 16 mm, threading M3	0.001
26.008-F	Plexi stick pointed end, Ø 4.50 x L 16 mm, threading M3	0.001
26.008-G	Plexi stick bevelled end, Ø 4.50 x L 16 mm (width 4.50 mm), threading M3	0.001
26.008-H	Brass stick pointed end, Ø 4.50 x L 16 mm, threading M3	0.001
26.008-I	Hardened steel scriber HRC 60 +/-1, threading M3	0.001
26.008-02	Wooden box	0.120

Optional :

MSA	Item	Kg
26.008-J	Hard metal scriber, threading M3	0.001

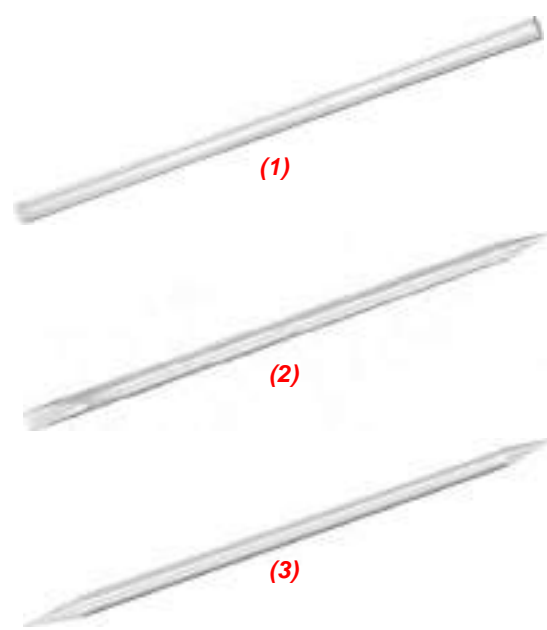

PLEXI

MSA		Ø	Shape	Length	Kg
26.280	(1)	2 mm	Flat ends	150 mm	0.001
26.287	(2)	2 mm	Pointed/chamfere ends	140 mm	0.003
26.281	(1)	4 mm	Flat ends	150 mm	0.001
26.288	(2)	4 mm	Pointed/chamfere ends	140 mm	0.003
26.286	(3)	5 mm	Pointed/pointed ends	140 mm	0.003
26.285	(2)	5 mm	Pointed/chamfere ends	140 mm	0.003
26.282	(1)	5 mm	Flat ends	150 mm	0.003
26.283	(1)	6 mm	Flat ends	150 mm	0.005
26.284	(1)	8 mm	Flat ends	150 mm	0.009
-	-	-	-	-	-
26.280-M		2 mm	Flat ends	1000 mm	0.011
26.281-M		4 mm	Flat ends	1000 mm	0.011
26.282-M		5 mm	Flat ends	1000 mm	0.020
26.283-M		6 mm	Flat ends	1000 mm	0.033
26.284-M		8 mm	Flat ends	1000 mm	0.060

Transparent plastic sticks.

CLEANING

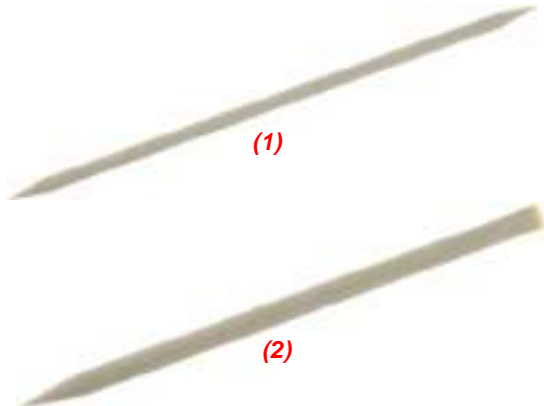

PEEK

MSA		Ø	Shape	Length	Kg
26.289-04	(1)	4 mm	Pointed/pointed ends	140 mm	0.003
26.289-06	(2)	6 mm	Pointed/chamfered ends	140 mm	0.005

PEEK stick.

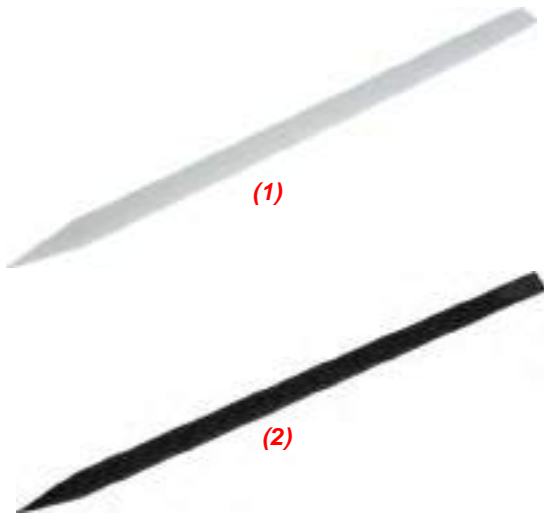

POM

MSA		Colour	Ø	Length	Kg
26.257	(1)	White	6 mm	140 mm	0.006
26.256	(2)	Black	6 mm	140 mm	0.006

Cleaning peg stick, pointed/bevelled ends.
Material : POM plastic (Polyoxymethylene).



MSA		Ø	Length	Kg
26.252-04	(1)	4 mm	125 mm	0.002
26.252-06	(2)	6 mm	125 mm	0.003
26.252-10	(3)	10 mm	125 mm	0.005

Paper stick, ideal for cleaning. Absorbent.

Cleaning swabs.



MSA		Ø	Length	Kg
26.670-05	(1)	5 mm	106 mm	0.010

Cleaning swab Ruby Stick with rubber head.

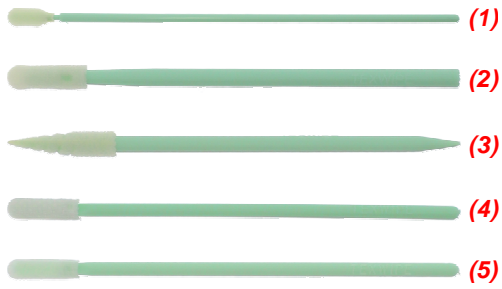

MSA		Head size	Quantity	Length	Kg
26.679-A	(1)	17.0 x 6.2 mm	500	163 mm	?
26.679-B	(2)	12.0 x 4.0 mm	500	71 mm	?
26.679-C	(3)	16.0 x 3.5 mm	500	67 mm	?
26.679-D	(4)	11.0 x 3.2 mm	500	70 mm	?
26.679-E	(5)	10.0 x 3.2 mm	500	70 mm	?

Cleaning swab with plastic body and polyurethane foam head.

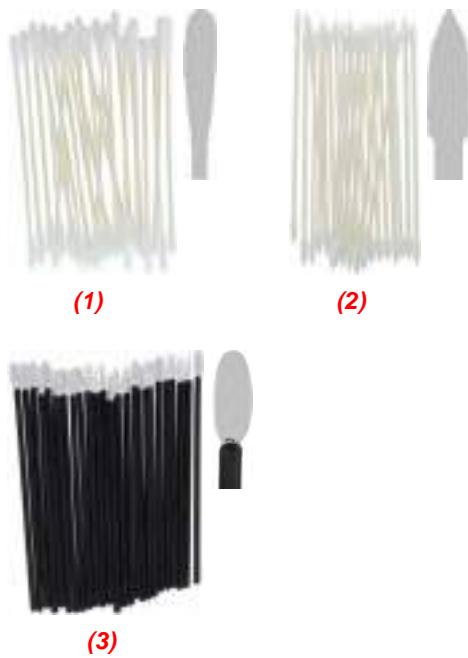

MSA		Ø	Quantity	Length	Kg
26.671	(1)	3.20 mm	25	75 mm	0.005
26.672	(1)	2.60 mm	25	75 mm	0.004
26.673	(2)	3.00 mm	25	75 mm	0.004
26.676	(2)	1.80 mm	25	75 mm	0.009
26.675	(3)	-	25	75 mm	0.009

Cleaning swab.

- (1) With double-end round cotton heads
- (2) With double-end pointed cotton heads
- (3) With single-end flat cotton head, width 3 mm x thickness 0.50 mm

CLEANING

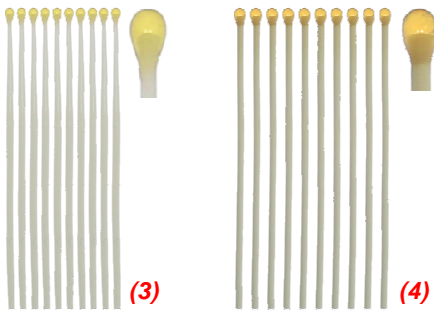
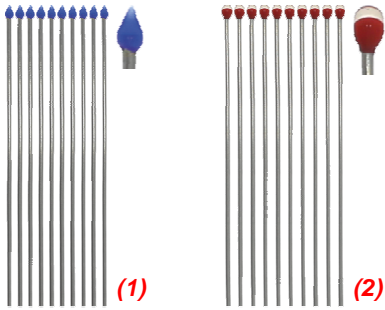

MSA		Ø	Quantity	Length	Kg
26.677-B	(1)	2.50 mm	10	75 mm	0.003
26.677-R	(2)	2.50 mm	10	75 mm	0.003
26.677-T	(3)	2.00 mm	10	70 mm	0.003
26.677-Y	(4)	3.00 mm	10	75 mm	0.003
26.674	(5)	2.20 mm	20	75 mm	0.017

Cleaning swab with adherent head.

- (1) Stainless steel body and blue silicone gel head
- (2) Stainless steel body and red and transparent silicone gel head
- (3) ABS body and transparent silicone gel head
- (4) Paper body and light yellow silicone gel head
- (5) ABS body and transparent silicone gel head

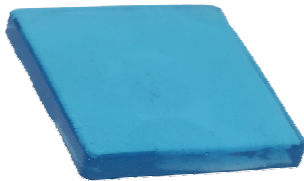

MSA	Size	Kg
26.678	45 x 45 x 45 mm	0.015

Blue sticky pad for cleaning swabs MSA26.677-x.
Delivered in a plastic box.

Cleaning pens.



MSA	Size	Kg
26.177	Ø 17 x 125 mm	0.051

Pen with 2 different tips for cleaning watch crystals and dials.
1 side with a retractable brush Ø 14 mm and 1 side with a felt tip Ø 13 mm.

Spare part :

MSA	Item	Kg
26.177-A	Felt tip Ø 13 mm	0.005



MSA	Size	Kg
26.178	Ø 11 x 90 mm	0.025

Pen with 2 different tips for cleaning watch crystals and dials.
1 side with a retractable brush Ø 8 mm and 1 side with a felt tip Ø 8 mm.

Benzine, acetone and isopropyl alcohol.



MSA	Contents	Kg
26.704-01	1 litre	0.800
26.704-05	5 litres	3.500
26.704-10	10 litres	7.000
26.704-25	25 litres	18.000
26.704-60	60 litres	43.000

Light fractional benzine 60/90 for cleaning.

Attention : this product cannot be exported (only for the Swiss market).



MSA	Contents	Kg
26.705-01	1 litre	0.980
26.705-05	5 litres	4.000
26.705-10	10 litres	8.000
26.705-25	25 litres	20.500
26.705-60	60 litres	49.000

Pure chemical acetone 99.5% for cleaning.

Attention : this product cannot be exported (only for the Swiss market).



MSA	Contents	Kg
26.706-01	1 litre	0.865
26.706-05	5 litres	4.000
26.706-10	10 litres	8.000
26.706-25	25 litres	20.500
26.706-60	60 litres	49.000

Isopropyl alcohol 99.9% for cleaning.

Attention : this product cannot be exported (only for the Swiss market).

Cleaning and rising solutions.



MSA	Product	Contents	Kg
26.728	REGULA R	5 litres	4.200
26.730	REGULA R	25 litres	22.000

REGULA® R cleaning solution for watches.
Use as first bath.



MSA	Product	Contents	Kg
26.729	REGULA S	5 litres	3.700
26.731	REGULA S	25 litres	19.000

REGULA® S rinsing solution for watches.
Use as second bath after REGULA® R cleaning solution.



MSA	Product	Contents	Kg
26.708	RUBISOL	1 litre	0.940
26.709	RUBISOL	2 litres	1.780
26.710	RUBISOL	5 litres	4.330
26.720	RUBISOL	25 litres	22.000

RUBISOL® cleaning solution without water for watches.
Use as first bath. Inflammable and noncorrosive.
Rapidly dissolves solidified oils.



MSA	Product	Contents	Kg
26.718	F45	1 litre	1.070
26.727	F45	2 litres	2.000
26.711	F45	5 litres	5.000
26.717	F45	25 litres	24.000

F45® rinsing solution without acid or grease, use pure. Inflammable,
corrosive and dries quickly.
Rapidly dissolves all oils currently used in the watch making industry.



MSA	Product	Contents	Kg
26.719	PF80	1 litre	0.900
26.726	PF80	2 litres	1.800
26.714	PF80	5 litres	4.180
26.721	PF80	25 litres	21.000

PF80® rinsing solution with a very strong dissolving action.
Use as second or third rinse bath after RUBISOL® cleaning solution.
Without water, acid or grease.



MSA	Product	Contents	Kg
26.702	RG-1	25 litres	26.400

RG-1® cleaning solution for watch cleaning machines.



MSA	Product	Contents	Kg
26.703	RG-3	25 litres	19.400

RG-3® rinsing solution for watch cleaning machines.



MSA	Product	Contents	Kg
26.734	WF 5	5 litres	4.075

GREINER® WF 5 cleaning solution.



MSA	Product	Contents	Kg
26.735	S-3	5 litres	3.810

GREINER® S-3 rinsing solution.



MSA	Product	Contents	Kg
26.736	111	3.8 litres	3.275

L&R® 111 cleaning solution, with ammoniac for complete cleaning.



MSA	Product	Contents	Kg
26.737	3	3.8 litres	3.160

L&R® 3 rinsing clear solution, fast drying, petrol distillation.
Do not contain chlorinated solvent or benzol. No grease remaining after use.

ELMA® solutions.



MSA	Product	Contents	Kg
26.845	WF PRO	2.5 litres	2.800
26.846	WF PRO	10 litres	?
26.847	WF PRO	30 litres	?

ELMA® WF PRO is a cleaning solution microemulsion-based detergent for use with mechanical precision parts, such as dismantled and assembled watch movements, in cleaning systems with or without ultrasound. It cleans gently with excellent results. It provides good material compatibility and cleans, removes resins and dissolves oxides (brightens) in a single step. This solution helps to ensure a very long service life.



MSA	Product	Contents	Kg
26.848	SUPROL PRO	2.5 litres	2.800
26.849	SUPROL PRO	10 litres	?
26.850	SUPROL PRO	30 litres	?

ELMA® SUPROL PRO is a non-aqueous detergent for rinsing precision parts, such as dismantled and assembled watch movements, after they were cleaned. Cleaning solutions like ELMA® WF PRO rinse off completely. This product evaporates quickly without residue and ensures that lubricants can be applied evenly. In aqueous cleaning of precision metal parts, it can also be used to displace water before drying.



MSA	Product	Contents	Kg
26.828	1:9	1/2 litre	0.525
26.830	1:9	1 litre	1.200
26.829	1:9	2.5 litres	5.300

ELMA® 1:9 cleaning solution. Aqueous concentrate for cleaning disassembled watch parts and high precision metal pieces. Hardened oils are carefully and rapidly removed. Gives light effect to alloy gold and brass.



MSA	Product	Contents	Kg
26.824	CLEAN 225 SONIC	1 litre	1.200
26.823	CLEAN 225 SONIC	5 litres	6.000
26.825	CLEAN 225 SONIC	10 litres	11.000

ELMA® CLEAN 225 SONIC is an alkaline liquid concentrated cleaning solution for metals after a mechanical work.



MSA	Product	Contents	Kg
26.800	SUPER CLEAN	1 litre	1.100

ELMA® SUPER CLEAN is an aqueous, ammonia-based cleaning concentrate for universal cleaning of gold, silver and jewellery that contains hard gemstones.

It brightens tarnished gold, silver or alloys and removes grease, emulsions, dust and sweat residue.

Use diluted between 3 and 10%.



MSA	Product	Contents	Kg
26.820	CLEAN 75	1 litre	1.100

ELMA® CLEAN 75 is a cleaning concentrate solution used in ultrasonic baths to remove dirt particles, grease and oils (plant-, animal- and mineral oil-based fats) as well as residues from grinding, polishing or lapping (Parisian Red and other polishing pastes and waxes).

It cleans every piece of jewellery thoroughly and brightens precious and non-ferrous metal parts. This product is not suitable for jewellery made of zinc, aluminium, light alloys or soft/delicate stones such as pearls, corals, opals, etc.

Use diluted between 5 and 10%.



MSA	Product	Contents	Kg
26.852	LUXURY CLEAN	1 litre	?

ELMA® LUXURY CLEAN EC 90 is an aqueous neutral cleaning concentrate for cleaning watch and jewelry parts made of metal (including aluminum), soft stones (e.g. amber) as well as pearls and corals.

In addition, EC 90 has a brightening effect and integrated tarnish protection.



MSA	Product	Contents	Kg
26.810	NOBLE CLEAN	1 litre	1.200
26.811	NOBLE CLEAN	10 litres	10.800

ELMA® NOBLE CLEAN cleaning solution. This acidic detergent cleans intensively and brightens jewellery and alloys made from precious metal within seconds. The cleaner is also available in a handy 1-litre round bottle with a wide neck for immersing jewellery and cutlery. After you rinse the precious metal parts with cold water, the temporary anti-tarnish finish will prevent tarnishing for a long time.

Elma Noble Clean is cyanide-free and provides relatively equal results to highly toxic jewellery cleaners containing cyanide.

Ready for use bath.

Solutions for scouring and removing broken screws.



MSA	Contents	Size	Kg
26.585	800 g	Ø 100 x 142 mm	0.852

BORAX powder (sodium tetraborate decahydrate).



MSA	Contents	Kg
26.590	1 litre	1.130

LYCOBOHR, liquor of boron. Use as scouring solution before soldering.



MSA	Contents	Kg
26.950	1 Kg	1.100
26.951	10 Kg	11.000

Scouring powder NET'OR for precious and nonferrous metals. In an acid resistant recipient, mix 4 litres of hot water with 1 kg of powder. Soak the objects to be cleaned and let it react. Class 3 toxicity.



MSA	Contents	Size	Kg
26.640-050	50 ml	35 x 35 x 70 mm	0.070
26.640-500	1/2 litre	80 x 55 x 150 mm	0.625
26.640	1 litre	95 x 70 x 205 mm	1.215

VISSIN solution for removing broken screws. Easy and simple use with the tripod MSA26.646 and the ceramic bowl MSA26.645 (both items are flame resistant).



MSA	Size	Kg
26.645	Ø 100 x 40 mm	0.085

Ceramic bowl. Use with tripod MSA26.646.



MSA	Size	Kg
26.646	Ø 96 x 140 mm	0.070

Tripod for ceramic bowl MSA26.645, with stainless steel legs and aluminium top ring.

Deoxidising solution.

MSA	Contents	Kg
26.762	1 litre	1.245

Ready-to-use, slightly acidic DESOXYFINISH solution, for deoxidising brass, copper and its alloys, gold and its alloys, and silver, without attacking them, while preserving their brilliance.

Temperature : 20 - 50° C.

Anti-limestone product.

MSA	Volume	Kg
26.754	500 ml	0.540

Anti-limestone product.

Waterproofing fluids for watch cases.

MSA	Contents	Size	Kg
26.655	20 ml	Ø 28 x 62 mm	0.032

MAGIC GASKET waterproof liquid. The cap is equipped with a brush to apply the liquid at the junction of the case and the case back, or at the junction of the case and the glass. It dries once applied. Just before the liquid is completely dried, it is easy to remove the extra liquid with a cloth or a finger.



MSA	Contents	Size	Kg
26.812	25 ml	Ø 30 x 90 mm	0.100

ELMA® VACU-PROOF for waterproofing watches, cases, crowns, glasses, etc.

The bottle is equipped with a dripping pipe for an easy liquid application.

ONE-DIP® solution.

MSA	Contents	Kg
26.650	50 ml	0.175

ONE-DIP® cleaning solution for hairsprings, balances, levers and stones encrusted with hardened oil, etc.

Circuit repair solution.



MSA	Contents	Kg
26.623	1.5 ml	0.065

Circuit Maker.
Repairs quartz analog and digital circuitry as well as any other fine wire circuits with a minimum of time and effort.
Eliminates long drying times.
Kit includes 1 bottle with 1.5 ml fluid and an applicator.

Protection varnish.

Refer to the "Protections" chapter of the WATCH PARTS SERVICE catalogue, for protective adhesives and masking.



MSA	Contents	Kg
26.913-100	100 ml	0.128
26.913-1L	1 Kg	1.075
26.913-5L	5 Kg	5.250

White saving varnish KIWOMASK W 128, to be used to hide certain parts of a piece during polishing, engraving, thinning, etc.
Apply in uniform layers with a paintbrush and remove dry or with water.

Luminous pigments for dials and hands.



MSA	Colour	Packaging size	Kg
26.495	White C1	87.50 x 59.70 x 23.40 mm	0.039
26.494	Yellow C3	87.50 x 59.70 x 23.40 mm	0.039
26.493	Green C5	87.50 x 59.70 x 23.40 mm	0.039

Assortment of 3 small bottles of 1 g (luminous powder, glue and dilution), 1 small cup and 1 applicator.
 Delivered in a plastic box with use instructions in French, English and German.

ASSORTMENT



MSA	Contents	Colour	Kg
26.486-001	1 g	White C1	0.005
26.486-010	10 g	White C1	0.026
26.485-001	1 g	Yellow C3	0.005
26.485-010	10 g	Yellow C3	0.026
26.484-001	1 g	Green C5	0.005
26.484-010	10 g	Green C5	0.026

Luminous powder, non radioactive.



MSA	Contents	Colour	Kg
26.486-E01	1 g	White C1	0.005
26.486-E50	50 g	White C1	0.026
26.485-E01	1 g	Yellow C3	0.005
26.484-E01	1 g	Green C5	0.005

Extra-fine luminous powder NEWLITE 2002, non radioactive.



MSA	Contents	Colour	Kg
26.486-050	50 g	White	0.026
26.486-050F	50 g	White *	0.026

Luminous powder SUPER LUMINOVA, non radioactive.
 * Extra-fine granulometry



MSA	Contents	Kg
26.487-001	1 g	0.005
26.487-050	50 g	0.115
26.487-100	100 g	0.130

Glue for luminous material MSA26.484-xxx, 26.485-xxx and 26.486-xxx.



MSA	Contents	Kg
26.488-001	1 g	0.005
26.488-050	50 g	0.112
26.488-100	100 g	0.130

Diluent for luminous material MSA26.484-xxx, 26.485-xxx and 26.486-xxx.



MSA	Size	Kg
26.099	(A4) 210 x 297 mm	0.009

Anti-rust paper, to be also used for medical purposes.



MSA	Colour	Size	Kg
26.080	Red	Ø 11 x 115 mm	0.015
26.081	Black	Ø 11 x 115 mm	0.015

LISTO greasy pen for marking on any support.

Spare parts :

MSA	Item	Kg
26.080-A	Set of 6 red leads	0.006
26.081-A	Set of 6 black leads	0.006

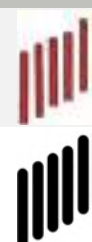



THREADLOCKING

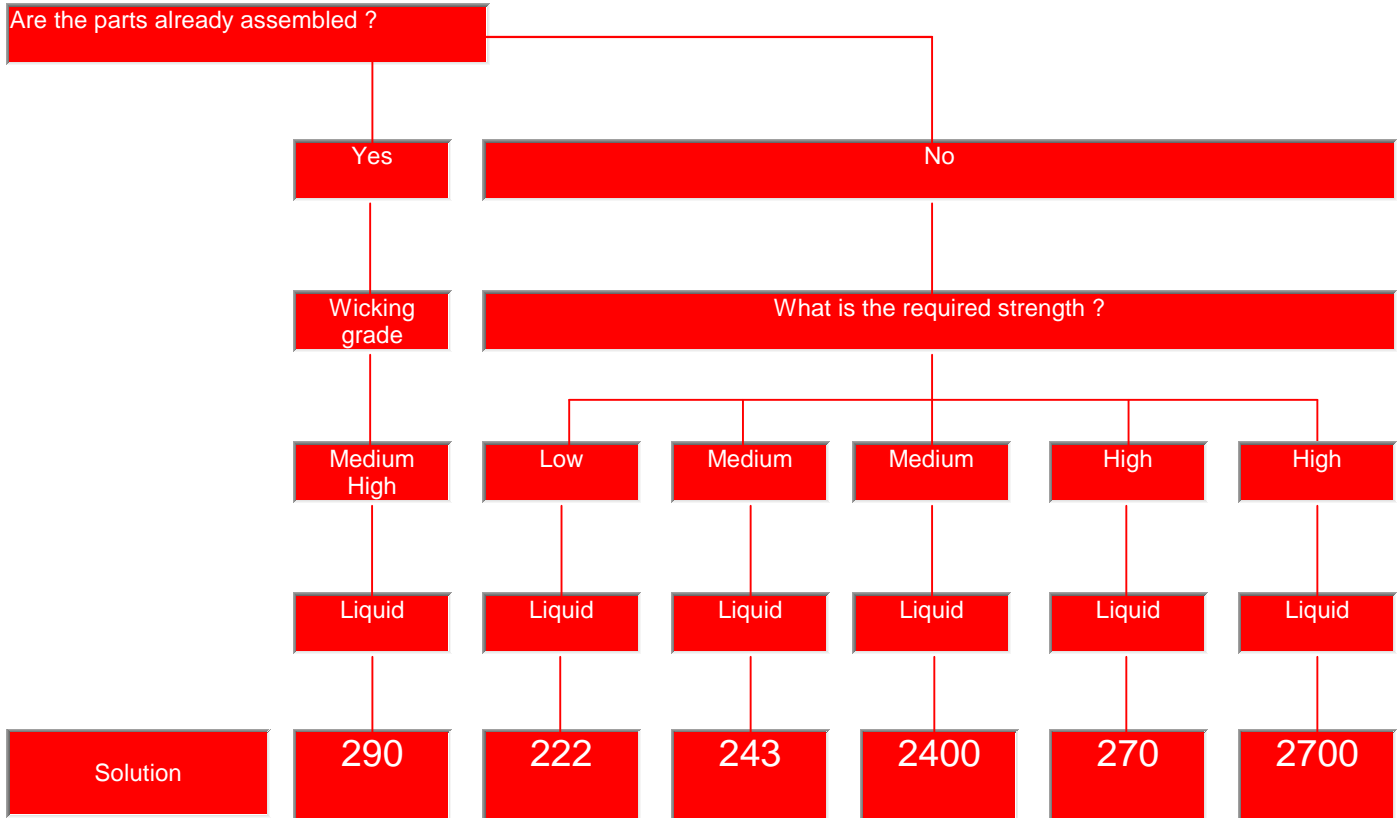

(1)



(2)



(3)



(4)



(5)



(6)

- Prevent unwanted movements, loosening, leakage and corrosion
- Resistant to vibrations
- Single component products, clean and easy application
- Useable on assemblies of all sizes
- Sealing of threads.

LOCTITE**Products list (thread locking) :**

MSA	No.	Vol.	Colour	Fixture time on steel	Ø max.	Temp.	Strength	Breakaway torque	Viscosity mPa.s
26.541	221	10 ml	Fluo purple	25 min.	M12	-55...+150° C	Low	8.5 N.m	100-150
26.542	221	50 ml	Fluo purple	25 min.	M12	-55...+150° C	Low	8.5 N.m	100-150
26.520	(2) 222	10 ml	Fluo purple	15 min.	M36	-55...+150° C	Low	6 N.m	900-1500
26.521	222	50 ml	Fluo purple	15 min.	M36	-55...+150° C	Low	6 N.m	900-1500
26.601	241	10 ml	Opaque fluo Blue	35 min.	M12	-55...+150° C	Medium	11.5 N.m	100-150
26.548	241	50 ml	Opaque fluo Blue	35 min.	M12	-55...+150° C	Medium	11.5 N.m	100-150
26.537	242	10 ml	Fluo blue	5 min.	M36	-55...+150° C	Medium	11.5 N.m	800-1600
26.538	242	50 ml	Fluo blue	5 min.	M36	-55...+150° C	Medium	11.5 N.m	800-1600
26.522	(3) 243	10 ml	Fluo blue	10 min.	M36	-55...+180° C	Medium	26 N.m	1300-3000
26.523	243	50 ml	Fluo blue	10 min.	M36	-55...+180° C	Medium	26 N.m	1300-3000
26.523-250	243	250 ml	Fluo blue	10 min.	M36	-55...+180° C	Medium	26 N.m	1300-3000
26.605	262	50 ml	Fluo red	15 min.	M25	-55...+150° C	Medium /High	22 N.m	1200-2400
26.555-19	268	Stick 19 g	Fluo red	5 min.	M50	-55...+150° C	High	17 N.m	-
26.524	(5) 270	10 ml	Fluo green	10 min.	M20	-55...+180° C	High	33 N.m	400-600
26.525	270	50 ml	Fluo green	10 min.	M20	-55...+180° C	High	33 N.m	400-600
26.586-050	278	50 ml	Green	20 min.	M36	-55...+200° C	High	42 N.m	2400-3600
26.526	(1) 290	10 ml	Fluo green	20 min.	M6	-55...+150° C	Medium /High	10 N.m	20-55
26.527	290	50 ml	Fluo green	20 min.	M6	-55...+150° C	Medium /High	10 N.m	20-55
26.632-050	(4) 2400	50 ml	Fluo blue	10 min.	M36	-55...+150° C	Medium	20 N.m	225-475
26.633-050	(6) 2700	50 ml	Fluo green	5 min.	M20	-55...+150° C	High	20 N.m	350-550
26.554-010	2701	10 ml	Fluo green	10 min.	M20	-55...+150° C	High	38 N.m	500-900
26.554-050	2701	50 ml	Fluo green	10 min.	M20	-55...+150° C	High	38 N.m	500-900
26.554-250	2701	250 ml	Fluo green	10 min.	M20	-55...+150° C	High	38 N.m	500-900



CYLINDRICAL ASSEMBLIES

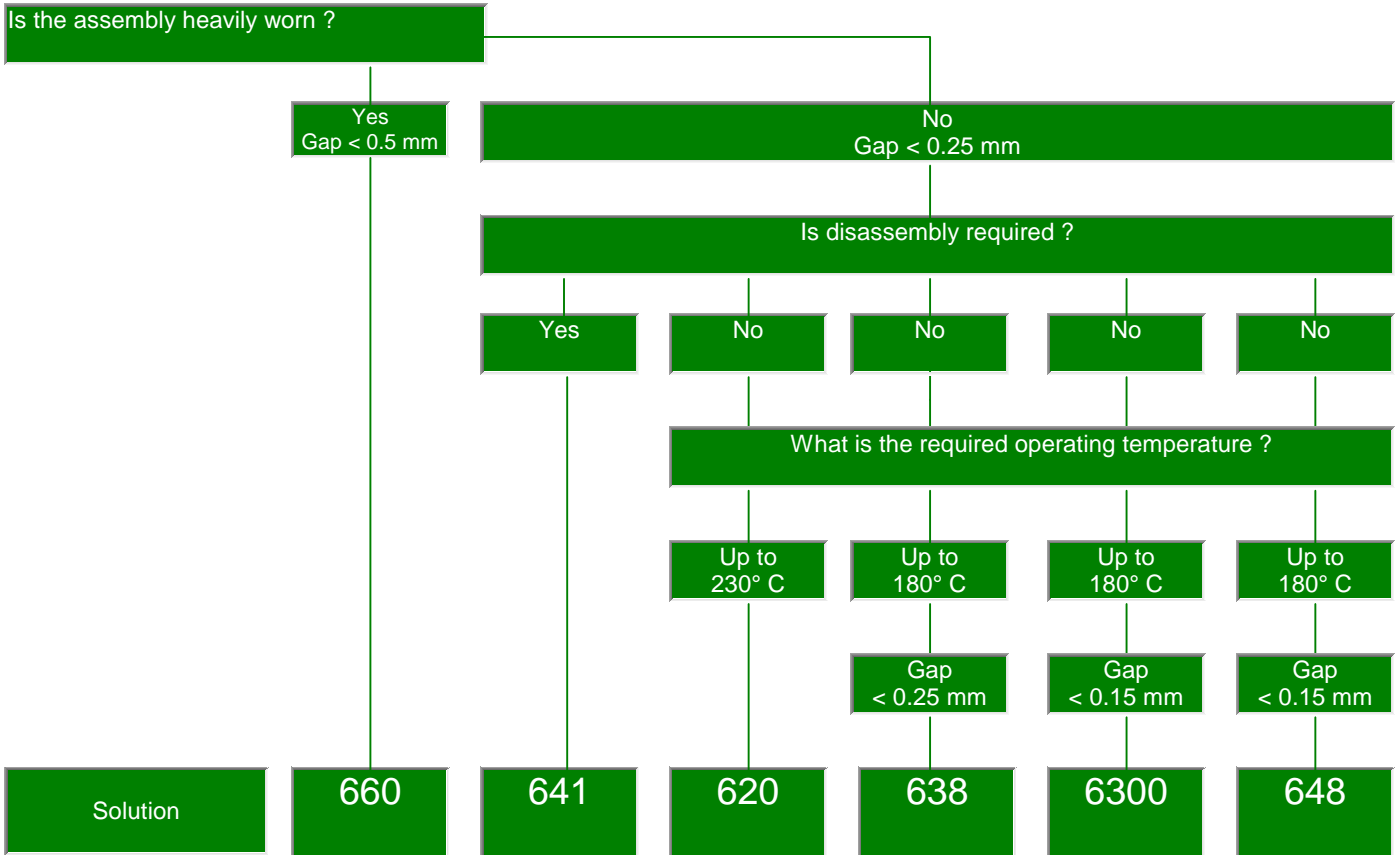

(1)



(2)



(3)



(4)



(5)



(6)

- High strength products can withstand high loads
- Full filling of gaps to prevent corrosion and fretting
- Uniform stress distribution.

LOCTITE**Products list (cylindrical assemblies) :**

MSA	No.	Vol.	Colour	Fixture time on steel	Temp.	Viscosity mPa.s
26.543	601	10 ml	Fluo Green	25 min.	-55...+150° C	100-150
26.511	601	50 ml	Fluo Green	25 min.	-55...+150° C	100-150
26.528	603	10 ml	Fluo Green	8 min.	-55...+150° C	100-150
26.529	603	50 ml	Fluo Green	8 min.	-55...+150° C	100-150
26.529-250	603	250 ml	Fluo Green	8 min.	-55...+150° C	100-150
26.589-050 (3)	620	50 ml	Green	80 min.	-55...+230° C	5000-12000
26.530 (4)	638	10 ml	Fluo Green	4 min.	-55...+180° C	2000-3000
26.531	638	50 ml	Fluo Green	4 min.	-55...+180° C	2000-3000
26.531-250	638	250 ml	Fluo Green	4 min.	-55...+180° C	2000-3000
26.539	641	10 ml	Yellow	25 min.	-55...+150° C	400-800
26.540 (2)	641	50 ml	Yellow	25 min.	-55...+150° C	400-800
26.532-010	648	10 ml	Fluo Green	3 min.	-55...+180° C	400-600
26.532 (6)	648	50 ml	Fluo Green	3 min.	-55...+180° C	400-600
26.532-250	648	250 ml	Fluo Green	3 min.	-55...+180° C	400-600
26.556-050 (1)	660	50 ml	Silver	15 min.	-55...+150° C	150000-350000
26.634-050 (5)	6300	50 ml	Fluo Green	10 min.	-55...+180° C	250-550



INSTANT ADHESIVES

What type of material are you bonding ?

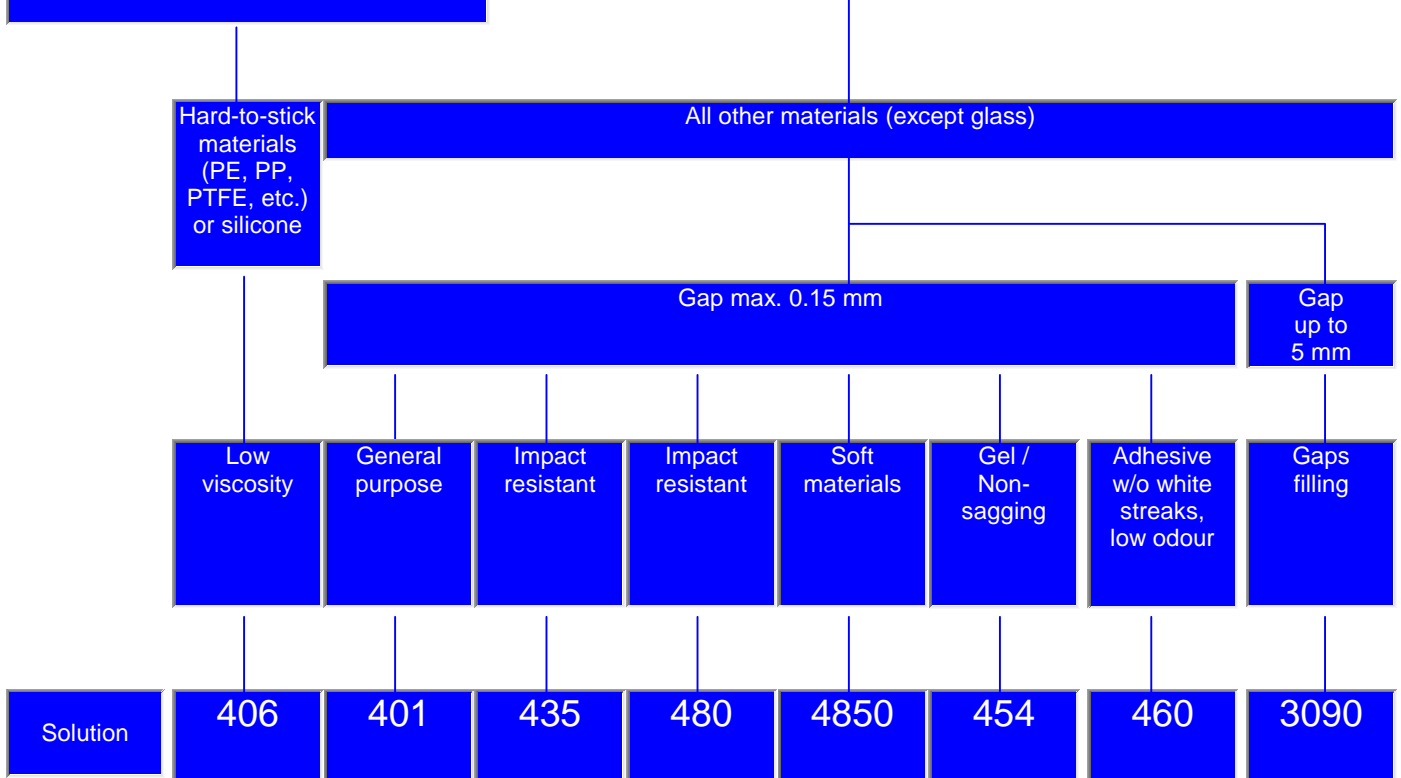

(1)



(2)



(3)



(4)



(5)



(6)



(7)



(8)

LOCTITE

- Clean and easy application.
- Very fast positioning and fixing of parts.
- Bonding of a wide range of materials.
- Excellent adhesion to a wide range of substrates, particularly plastics and rubbers. LOCTITE SF 770 and SF 7239 primers are designed to improve adhesion on hard-to-stick materials such as PP, PE, POM, PTFE or silicone.
- High resistance on very small surfaces. Solvent free.

Products list (instant adhesives) :

MSA	No.	Vol.	Colour	Fixture time	Temp.	Viscosity mPa.s
26.533-003	401	3 g	Transparent and colourless	3 - 10 s	-40...+120° C	100
26.533	(2) 401	20 g	Transparent and colourless	3 - 10 s	-40...+120° C	100
26.533-100	401	100 g	Transparent and colourless	3 - 10 s	-40...+120° C	100
26.536	(1) 406	20 g	Transparent and colourless	2 - 10 s	-40...+120° C	20
26.536-500	406	500 g	Transparent and colourless	2 - 10 s	-40...+120° C	20
26.518-020	431	20 g	Transparent and colourless	5 - 10 s	-40...+80° C	1000
26.587-020	(3) 435	20 g	Transparent and colourless	10 - 20 s	-40...+100° C	200
26.558-010	454	10 g	Transparent and colourless	5 - 10 s	-40...+120° C	Gel
26.558-020	(6) 454	20 g	Transparent and colourless	5 - 10 s	-40...+120° C	Gel
26.609	(7) 460	20 g	Transparent and colourless	5 - 20 s	-40...+80° C	40
26.519	(4) 480	20 g	Black	20 - 50 s	-40...+100° C	200
26.519-500	480	500 g	Black	20 - 50 s	-40...+100° C	200
26.534	496	20 g	Transparent and colourless	10 - 30 s	-40...+80° C	125
26.548-020	4062	20 g	Transparent and colourless	2 - 5 s	-40...+80° C	2
26.588-020	4204	20 g	Transparent and colourless	10 - 30 s	-40...+120° C	4000
26.559-020	(5) 4850	20 g	Transparent and colourless	3 - 10 s	-40...+80° C	400

Other Loctite® adhesives.

Structural bonding - Acrylics.

LOCTITE



MSA	Contents	Packaging size	Kg
26.582-0005	0.5 ml	165 x 100 x 10 mm	0.005

Glue AA 319. Single-component acrylic adhesive for bonding materials such as glass, metal, ceramics and plastics.
 Colour : light amber.
 Viscosity : 2750 mPa.s.
 Fixing time : 1 minute.
 Maximum temperature : +120° C.

LOCTITE



MSA	Contents	Kg
26.614	50 / 18 ml	?

Multi-Bond® adhesive kit, AA 330 tube and SF 7388 bottle.
 A versatile structural adhesive, ideal for bonding dissimilar substrates such as PVC, phenolic compounds and acrylic polymers.
 Colour : light yellow.
 Viscosity : 67500 mPa.s.
 Setting time : 3 minutes.
 Maximum temperature : +100° C.

Structural bonding - Epoxies.

LOCTITE



MSA	Contents	Size	Kg
26.594	50 ml / 56 g	112 x 45 mm	0.083

Glue EPOXY EA 9483. A two-component, flowable, transparent, general purpose epoxy adhesive. It is suitable for bonding and potting applications requiring high optical quality and strength.
 Colour : transparent.
 Viscosity : 7 mPa.s.
 Setting time : 210 minutes.
 Temperature : -55...+150° C.

LOCTITE

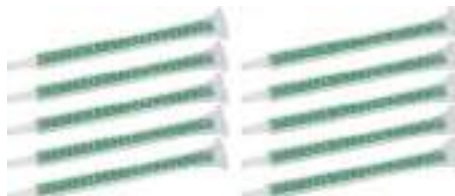

MSA	Quantity	Kg
26.629	10	0.040

Mixing tip for 2-component epoxy-polyurethane, 50 ml.
 Bag of 10 pieces.

Light-curing adhesives.

LOCTITE



MSA	Contents	Kg
26.535	50 ml	0.083

Glue AA 350. Acrylic based UV adhesive with good chemical and moisture resistance. This medium viscosity product is suitable for bonding glass and metals but can also be used on plastics and ceramics.
 Colour : transparent, light amber.
 Viscosity : 4500 mPa.s.
 Setting time : 15 seconds.
 Temperature : -40...120° C.

LOCTITE



MSA	Contents	Kg
26.503	250 ml	?

Glue AA 352. Acrylic adhesive that cures under the action of UV light / activator, with good resistance to chemicals and high humidity. It bonds glass, metals and ceramics.
 Colour : transparent, amber.
 Viscosity : 15000 mPa.s.
 Setting time : 10 seconds.
 Temperature : -40...150° C.

LOCTITE



MSA	Contents	Size	Kg
26.512	25 ml	Ø 40 x 120 mm	0.050

Glue 3491 for watch mineral and sapphire glasses.
 High transparency, low yellowing.
 Application by automatic system MSA19.770 or MSA19.771 (see chapter 19).
 Fast drying with an UV drier (see chapter 19).
 Colour : clear.
 Viscosity : 1100 mPa.s.
 Setting time : 12 seconds.
 Temperature : -40...130° C.

LOCTITE



MSA	Contents	Size	Kg
26.584-025	25 ml	Ø 40 x 120 mm	?

Glue 3494. Highly transparent UV acrylic adhesive. Low yellowing and very high viscosity.
 Colour : clear.
 Viscosity : 6000 mPa.s.
 Setting time : 8 seconds.
 Temperature : -40...120° C.

Threaded seal.

LOCTITE



MSA	Contents	Kg
26.544	10 ml	?

Adhesive 542. Thread sealant, medium strength. For fine pitch threaded connections in hydraulic and pneumatic circuits and small diameter fittings in general. Fast curing.
 Colour : brown.
 Maximum thread diameter : M26/R3/4".
 Viscosity : 400 - 800 mPa.s.
 Temperature : -55...150° C.

Cleaning of parts and hands.

LOCTITE



MSA	Contents	Kg
26.617	150 ml	?

Parts cleaner SF 7063.
 General-purpose product for cleaning and degreasing any kind of surface or machinery component before proceeding with a repair or assembly job involving LOCTITE® adhesives.
 It is a solvent-based cleaner and the product leaves no residue. Removes most greases, oils, lubrication fluids and metal cuttings.

Surface preparation.

LOCTITE



MSA	Contents	Kg
26.628	500 ml	?

SF 7649 is a solvent-based activator for surface preparation that provides for low temperature curing.
 This product is designed to promote the curing speed of LOCTITE® anaerobic adhesives and sealants without any significant loss of joint strength.
 It is especially recommended for applications with passive metals or inert surfaces and with large bond gaps.

LOCTITE



MSA	Contents	Kg
26.658	150 ml	?

SF 734 Activator.
A liquid, acetone-based product used when it is necessary to increase the cure rate of anaerobic structural adhesives and LOCTITE® sealants.

LOCTITE



MSA	Contents	Kg
26.659	10 g	?

The SF 770 is a polyolefin primer for surface preparation and is ideal for use with difficult-to-bond plastics.
This product is a primer used to make polyolefin and other low-energy surfaces suitable for bonding with LOCTITE® instant adhesives.
It is only recommended for difficult-to-bond substrates which include polyethylene, polypropylene, polytetrafluoroethylene (PTFE) and thermoplastic rubber materials.
It is not recommended in assemblies where high peel strength is required.

Other adhesives.



MSA	Contents	Packaging size	Kg
26.500	2x 15 ml	180 x 115 x 15 mm	0.052

ARALDIT® glue standard 90 minutes. It dries slowly but efficiently.
Recommended for ceramic, wood, glass, metal and marble.



MSA	Contents	Packaging size	Kg
26.501	2x 15 ml	180 x 115 x 15 mm	0.056

ARALDIT® glue rapid 5 minutes.
It dries quickly, for multiple uses.



MSA	Contents	Size	Kg
26.502	10 g	Ø 35 x 105 mm	0.026

SEIKO® S-314 UV glue for mineral and sapphire glasses.
Fast drying with an UV drier (see chapter 19).

Careful : do not apply this glue on acrylic resin glasses or plastic watch cases.



MSA	Contents	Size	Kg
26.516	9 ml	110 x 25 x 25 mm	0.015

Glue for plastic watch glasses. Equipped with a fine needle for easy application.

Air-drying without using an UV apparatus.

28



MOEBIUS® OILS	28 - 2
MOEBIUS® GREASES	28 - 13
MOEBIUS® SPECIALITIES	28 - 20
OILS AND GREASES LRCB	28 - 23
SEIKO® OILS AND GREASES	28 - 25
OTHER OILS AND GREASES	28 - 26
LUBRIBOX GREASES	28 - 29
LUBRICANTS	28 - 30
EPILAMES	28 - 33



TABLE OF OILING

Functions	Calibres		
	Sizes 5" - 18"	Large sizes (clock, alarm clock)	Quartz Movements
Balance staff, fast wheels with low torque	9010 8000 9030 (low temperature) 9040 (ultra-low temperature)	9020 8030	9000 9024
Pivoting wheels with moderate to high torque	Synt-HP * D-5	Synt-HP * D-5	
Pallets, escape wheel tothing	9415 941, 9010	9415 9020	
Barrel mainspring	8200, 8141, 8201		
Barrel wall	8217 8212 (Aluminium), 8213 (Brass)	8141 8201	
High friction, cannon pinion, time setting, various chrono mechanisms	9501, 9504 K-6 **, L-5 **	9504 K-6 **	
Winding mechanism, calendar	Synt-HP *, D-5 K-6 **, L-5 **		
Setting lever, pusher, winding, spring pin	8300, 8301, 8302		8300, 8301, 8302
O-ring, waterproof gasket and casing	8513, 8516, H-10	8513, 8516, H-10	8513, H-10
Ball bearing, springs	V106		
Reversing wheel, clicks	V105		

* : The choice of viscosity depends on the power reserves. Synt-HP oils are preferably used for ruby bearings. For brass bearings we recommend Microgliss D-4 or D-5.

** : Under certain conditions, these products may be preferred to standard products. For optimal efficiency, these products can also be diluted in a benzine-type solvent and applied when dipping before lubrication with the standard product.

Natural oils for watchmaking and micromechanics.



MSA	ml	Temp. ° C	Visc. 0° C	Visc. 20° C	Visc. 40° C	Kg
28.8000-001	1	-15...+80	280	95	41	0.005
28.8000-010	10	-15...+80	280	95	41	0.022

Natural oil for general purposes.
Suitable for wristwatches and pocket watches, except springs and winding mechanisms.
Light yellow aspect.

Moebius 8000



MSA	ml	Temp. ° C	Visc. 0° C	Visc. 20° C	Visc. 40° C	Kg
28.8030-020	20	-18...+80	440	115	47	0.055
28.8030-100	100	-18...+80	440	115	47	?

Natural oil for clocks, music box movements and any other kind of precise mechanisms.
See 8031 for lower temperatures.
Light yellow aspect.

Moebius 8030



MSA	ml	Temp. ° C	Visc. 0° C	Visc. 20° C	Visc. 40° C	Kg
28.8031-020	20	-25...+80	390	110	45	0.054

Natural oil for clocks, music box movements and any other kind of precise mechanisms.
Limpid yellow aspect.

Moebius 8031



MSA	ml	Temp. ° C	Visc. 0° C	Visc. 20° C	Visc. 40° C	Kg
28.8040-020	20	-27...+80	570	150	56	0.055
28.8040-100	100	-27...+80	570	150	56	?

Natural oil for cuckoo-clocks as well as from small until tower clocks, and any other kind of precise mechanisms.
Light yellow aspect.

Moebius 8040



MSA	ml	Temp. ° C	Visc. 0° C	Visc. 20° C	Visc. 40° C	Kg
28.8141-020	20	-4...+100	11000	1250	310	0.057
28.8141-100	100	-4...+100	11000	1250	310	?

Natural oil with excellent stability and resistance qualities, used for mechanisms under high pressures.
 Suitable for cup-bearings, centre wheels, barrel arbours, canon-pinions and certain parts of automatic winding mechanisms.
Yellow-brown aspect.

Moebius 8141

Synthetic oils for watchmaking and micromechanics.



MSA	ml	Temp. ° C	Visc. 0° C	Visc. 20° C	Visc. 40° C	Kg
28.9010-002	2	-30...+70	625	150	52	0.015
28.9010-010	10	-30...+70	625	150	52	0.037
28.9010-050	50	-30...+70	625	150	52	0.119
28.9010-1L	1000	-30...+70	625	150	52	1.615
-	-	-	-	-	-	-
28.9014-002	2	-35...+70	400	100	36	0.011
28.9014-010	10	-35...+70	400	100	36	0.033
28.9014-050	50	-35...+70	400	100	36	0.206

Moebius Synt-A-Lube 9010 - 9014

100% synthetic universal fluid thin oil based on ether and aliphatic alcohol with excellent resistance to ageing and good resistance to pressure. Also very effective for use under wet conditions.
 With excellent lubricity and outstanding grip, this oil is ideal for regulating parts and fast mobiles with low torque (pendulum pivots, escapements, certain wheels, etc.).
Aspect light blue-green (9010) and light yellow (9014).

9010-B

MSA	ml	Temp. ° C	Visc. 0° C	Visc. 20° C	Visc. 40° C	Kg
28.9010-B/002	2	-30...+70	625	150	52	0.015
28.9010-B/010	10	-30...+70	625	150	52	0.037
28.9010-B/050	50	-30...+70	625	150	52	0.206

9010-FL

MSA	ml	Temp. ° C	Visc. 0° C	Visc. 20° C	Visc. 40° C	Kg
28.9010-002F	2	-30...+70	625	150	52	0.015
28.9010-01F	10	-30...+70	625	150	52	0.054
28.9010-050F	50	-30...+70	625	150	52	0.206



--- 9010-B dark blue



9010-FL fluorescent ---



Moebius Synt-Visco-Lube 9020

MSA	ml	Temp. ° C	Visc. 0° C	Visc. 20° C	Visc. 40° C	Kg
28.9020-002	2	-25...+80	1450	270	78	0.015
28.9020-010	10	-25...+80	1450	270	78	0.037
28.9020-050	50	-25...+80	1450	270	78	0.207

100% synthetic universal fluid thin oil based on ether and aliphatic alcohol with excellent resistance to aging and good resistance to pressure. Also very effective for use under wet conditions. With excellent lubricity and outstanding grip, this oil is mainly used for precision micromechanics. Can also be used for bearing lubrication of small calibres used instead of 9010 if the pressure resistance is not sufficient. Also particularly used for big calibres with higher pressure resistance, for oscillating weights and any other mobile parts of automatic movements.
Light yellow aspect.

9020-FL



--- 9020-FL fluorescent

MSA	ml	Temp. ° C	Visc. 0° C	Visc. 20° C	Visc. 40° C	Kg
28.9020-002FL	2	-25...+80	1450	270	78	0.032
28.9020-010FL	10	-25...+80	1450	270	78	0.055
28.9020-050FL	50	-25...+80	1450	270	78	0.207

9020-RED

MSA	ml	Temp. ° C	Visc. 0° C	Visc. 20° C	Visc. 40° C	Kg
28.9020-050R	50	-25...+80	1450	270	78	0.207



Moebius Synta-Visco-Lube 9024.

MSA	ml	Temp. ° C	Visc. 0° C	Visc. 20° C	Visc. 40° C	Kg
28.9024-002	2	-25...+80	1450	270	80	0.013
28.9024-005	5	-25...+80	1450	270	80	0.022
28.9024-010	10	-25...+80	1450	270	80	0.037

100% synthetic rather fluid oil based on ether and aliphatic alcohol with excellent resistance to ageing. With excellent lubricity and outstanding grip, this oil is ideal for mobiles exposed to moderate pressure. Universal oil especially recommended for the lubrication of plastics.
Light yellow aspect.

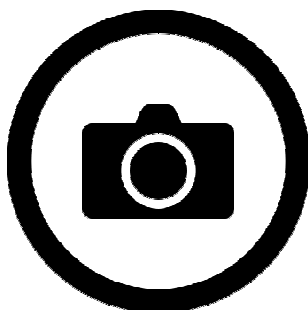

Moebius Synta-Visco-Lube 9026

MSA	ml	Temp. ° C	Visc. 0° C	Visc. 20° C	Visc. 40° C	Kg
28.9026-010	10	-25...+90	1800	235	72	0.030

Rather fluid 100% synthetic oil based on ether and aliphatic alcohol with excellent resistance to ageing. This oil provides both excellent lubricity and grip. The addition of molybdenum disulphide (MoS₂) enhances its lubricity and improves its resistance to pressure.
Black aspect.



Moebius Synta-Visco-Lube 9027

MSA	ml	Temp. ° C	Visc. 0° C	Visc. 20° C	Visc. 40° C	Kg
28.9027-005	5	-7...+80	7600	1050	242	0.022

Viscous 100% synthetic oil based on ether and aliphatic alcohol with excellent resistance to ageing and excellent grip. Providing an excellent lubricity at high viscosity this oil is particularly suitable for noise attenuation. It is especially recommended for metal/plastic as well as for plastic/plastic contacts.
Yellow aspect.



Moebius Synt-Frigo-Lube 9030

MSA	ml	Temp. ° C	Visc. 0° C	Visc. 20° C	Visc. 40° C	Kg
28.9030-002	2	-40...+60	180	60	25	0.015
28.9030-010	10	-40...+60	180	60	25	0.037
28.9030-050	50	-40...+60	180	60	25	0.205

100% synthetic fluid thin oil based on ether and aliphatic alcohol, exhibiting an excellent behavior under low temperatures conditions. Also very effective for use under wet conditions. With excellent lubricity and outstanding grip, this oil is ideal for high precision micromechanics. Recommended for the lubrication of mechanisms exposed to low temperatures such as watches, counters, weather instruments, car, aircraft and boat instruments. It is advisable to epilame movements that also operate at normal or slightly higher temperatures.
Orange-yellow aspect.

9030-FL

MSA	ml	Temp. ° C	Visc. 0° C	Visc. 20° C	Visc. 40° C	Kg
28.9030-002FL	2	-40...+60	180	60	25	0.030
28.9030-050FL	50	-40...+60	180	60	25	0.205

9030-GREEN

MSA	ml	Temp. ° C	Visc. 0° C	Visc. 20° C	Visc. 40° C	Kg
28.9030-050V	50	-40...+60	180	60	25	0.205



Moebius Synt-Frigo-Lube 9034

MSA	ml	Temp. ° C	Visc. 0° C	Visc. 20° C	Visc. 40° C	Kg
28.9034-002	2	-40...+60	180	60	24	0.010
28.9034-010	10	-40...+60	180	60	24	0.032

100% synthetic fluid thin oil based on ether and aliphatic alcohol. Exhibiting a very good lubrication and an outstanding grip, this oil is ideal for use under low temperatures conditions. This universal product is especially recommended for the lubrication of plastics. The resistance of oil on plastics is dependent of its surface layer, therefore the need for an epilame has to be checked each time.
Light yellow aspect.



Moebius Arctic 9040

MSA	ml	Temp. ° C	Visc. 0° C	Visc. 20° C	Visc. 40° C	Kg
28.9040-002	2	-52...+120	65	24	12	0.015
28.9040-010	10	-52...+120	65	24	12	0.044

100% synthetic very fluid and unctuous fine oil based on esters having a very good resistance to aging and having an extremely low degree of volatility.

This oil is specially designed for watches and precision instruments on boats and air crafts, parking meters and meteorological instruments working in low temperature conditions. It is also suitable for higher temperatures.

Due to low viscosity, this oil tends of spreading at normal temperature and it is recommended to do an epilame-coating.

Light yellow aspect.



Moebius Syntescap 941

MSA	ml	Temp. ° C	Visc. 0° C	Visc. 20° C	Visc. 40° C	Kg
28.941-002	2	-15...+70	340	105	42	0.011
28.941-010	10	-15...+70	340	105	42	0.034
28.941-050	50	-15...+70	340	105	42	0.207

Special synthetic oil for pallets lubrication. Suitable for any watch and clock calibres.

100% synthetic fluid thin oil based on ether and aliphatic alcohol with excellent resistance to ageing. With excellent lubricity and outstanding grip, this oil is ideal for lubrication of pallets.

Suitable for all watch calibres, clocks and timepieces within the limits of the usual alternatives.

Light yellow aspect.

941-FL

MSA	ml	Temp. ° C	Visc. 0° C	Visc. 20° C	Visc. 40° C	Kg
28.941-002FL	2	-15...+70	340	105	42	0.011
28.941-050FL	50	-15...+70	340	105	42	0.207



Moebius Synt-HP 500 (9101)

MSA	ml	Temp. ° C	Visc. 0° C	Visc. 20° C	Visc. 40° C	Kg
28.9101-002	2	-30...+100	2300	500	156	0.017
28.9101-020	20	-30...+100	2300	500	156	0.070
28.9101-050	50	-30...+100	2300	500	156	0.100

Synthetic oil for mechanical watches (train wheels, barrels, steel/steel friction), on-board instruments, micromotors, miniature ball bearings, etc. The SYNT-HP is convenient for high pressure where stability is needed on precise mechanisms and where high demands are placed on the oil's ageing stability.

Red and fluorescent (-FL) red aspect. Light yellow aspect for colourless items (-SC).

9101-SC

MSA	ml	Temp. ° C	Visc. 0° C	Visc. 20° C	Visc. 40° C	Kg
28.9101-02S	2	-30...-100	2300	500	156	0.017
28.9101-20S	20	-30...-100	2300	500	156	0.070

9101-FL

MSA	ml	Temp. ° C	Visc. 0° C	Visc. 20° C	Visc. 40° C	Kg
28.9101-002FL	2	-30...+100	2300	500	156	0.017
28.9101-020FL	20	-30...+100	2300	500	156	0.070



Moebius Synt-HP 750 (9102)

MSA	ml	Temp. ° C	Visc. 0° C	Visc. 20° C	Visc. 40° C	Kg
28.9102-002	2	-35...+100	3300	750	220	0.017
28.9102-020	20	-35...+100	3300	750	220	0.070
28.9102-050	50	-35...+100	3300	750	220	0.100

Synthetic oil for mechanical watches (train wheels, barrels, steel/steel friction), on-board instruments, micromotors, miniature ball bearings, etc. The SYNT-HP is convenient for high pressure where stability is needed on precise mechanisms and where high demands are placed on the oil's ageing stability.

Red and fluorescent (-FL) red aspect. Light yellow aspect for colourless items (-SC).

9102-SC

MSA	ml	Temp. ° C	Visc. 0° C	Visc. 20° C	Visc. 40° C	Kg
28.9102-02S	2	-35...-100	3300	750	220	0.017
28.9102-20S	20	-35...-100	3300	750	220	0.070

9102-FL

MSA	ml	Temp. ° C	Visc. 0° C	Visc. 20° C	Visc. 40° C	Kg
28.9102-002FL	2	-35...+100	3300	750	220	0.017
28.9102-020FL	20	-35...+100	3300	750	220	0.070



Moebius Synt-HP 1000 (9103)

MSA	ml	Temp. ° C	Visc. 0° C	Visc. 20° C	Visc. 40° C	Kg
28.9103-002	2	-30...+100	4700	1000	312	0.017
28.9103-020	20	-30...+100	4700	1000	312	0.070
28.9103-050	50	-30...+100	4700	1000	312	0.100

Synthetic oil for mechanical watches (train wheels, barrels, steel/steel friction), on-board instruments, micromotors, miniature ball bearings, etc. The SYNT-HP is convenient for high pressure where stability is needed on precise mechanisms and where high demands are placed on the oil's ageing stability.

Red, light yellow (-SC) and fluorescent light yellow (-FL) aspects.

9103-SC

MSA	ml	Temp. ° C	Visc. 0° C	Visc. 20° C	Visc. 40° C	Kg
28.9103-02S	2	-30...-100	4700	1000	312	0.029
28.9103-20S	20	-30...-100	4700	1000	312	0.070
28.9103-50S	50	-30...-100	4700	1000	312	0.100

9103-FL

MSA	ml	Temp. ° C	Visc. 0° C	Visc. 20° C	Visc. 40° C	Kg
28.9103-002FL	2	-30...+100	4700	1000	312	0.017
28.9103-020FL	20	-30...+100	4700	1000	312	0.070
28.9103-050FL	50	-30...+100	4700	1000	312	0.100



Moebius Synt-HP 1300 (9104)

MSA	ml	Temp. ° C	Visc. 0° C	Visc. 20° C	Visc. 40° C	Kg
28.9104-002	2	-25...+100	5900	1250	380	0.017
28.9104-020	20	-25...+100	5900	1250	380	0.070
28.9104-050	50	-25...+100	5900	1250	380	0.100

Synthetic oil for mechanical watches (train wheels, barrels, steel/steel friction), on-board instruments, micromotors, miniature ball bearings, etc. The SYNT-HP is convenient for high pressure where stability is needed on precise mechanisms and where high demands are placed on the oil's ageing stability.

Red, light yellow (-SC) and fluorescent light yellow (-FL) aspects.

9104-SC

MSA	ml	Temp. ° C	Visc. 0° C	Visc. 20° C	Visc. 40° C	Kg
28.9104-02S	2	-25...-100	5900	1250	380	0.017
28.9104-20S	20	-25...-100	5900	1250	380	0.070
28.9104-50S	50	-25...-100	5900	1250	380	0.100

9104-FL

MSA	ml	Temp. ° C	Visc. 0° C	Visc. 20° C	Visc. 40° C	Kg
28.9104-02F	2	-25...+100	5900	1250	380	0.017
28.9104-20F	20	-25...+100	5900	1250	380	0.070
28.9104-50F	50	-25...+100	5900	1250	380	0.100

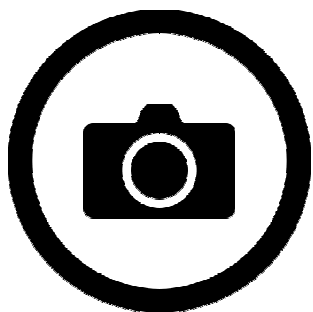

Moebius OSI-220 9800

MSA	ml	Temp. ° C	Visc. 0° C	Visc. 20° C	Visc. 40° C	Kg
28.9800-250	250	-30...+120	745	220	86	?

100% synthetic universal oil exhibiting with very good stability and lubricity. With an excellent viscosity index, this silicone-free oil has a stable viscosity even at low temperatures.

This product is ideal for an efficient lubrication over a wide temperature range.

Ligth yellow aspect.

"Microgliss" oil made of classic and silicon oils, for watchmaking and precision micromechanics.

The complete range of Microgliss lubricants is composed of 5 groups and was specifically conceived for watchmaking and precision mechanics.

Each group contains several products of different viscosities but with the same base.



Moebius Microgliss C-7

MSA	ml	Temp. ° C	Visc. 0° C	Visc. 20° C	Visc. 40° C	Kg
28.C7-1L	1000	-15...+100	2600	350	103	1.625

The Microgliss C-7 oil is a mixture of mineral and vegetable oils especially selected for their good lubricity. It presents both very good grip and very good ageing resistance.

Application : micromotors and lubrication problems in watchmaking (cup-bearings and centre wheels).

Yellow-brown aspect.

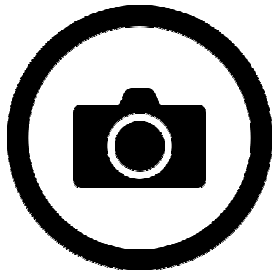

D-2



D-3



D-4



D-5

Moebius Microgliss (Group D)

MSA	ml	Temp. ° C	Visc. 0° C	Visc. 20° C	Visc. 40° C	Kg
28.D2-050	50	-30...+70	260	75	29	0.110
-	-	-	-	-	-	-
28.D3-020	20	-22...+80	900	190	64	0.055
28.D3-050	50	-22...+80	900	190	64	0.112
-	-	-	-	-	-	-
28.D4-020	20	-15...+80	1900	330	100	0.055
28.D4-050	50	-15...+80	1900	330	100	0.112
-	-	-	-	-	-	-
28.D5-020	20	-5...+80	7300	1200	295	0.055
28.D5-050	50	-5...+80	7300	1200	295	0.113
28.D5-1L	1000	-5...+80	7300	1200	295	0.899

The Microgliss D group is declined with several increasing viscosities from D-2 to D-5. These oils are a mixture of mineral and refined vegetable oils with special additives to provide very good stability and good resistance to pressure.

Oil D2 works well at low temperatures but a surface pre-treatment against spreading is needed (with epilame).

Oils D3, D4 and D5 are used in bearings exposed to high pressures according to safety margins.

Blue-green (D2 and D3) and brown-green (D4 and D5) aspects.

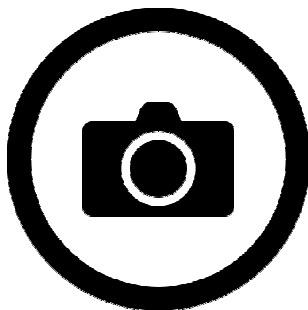

Moebius Silicone H-10

MSA	ml	Temp. ° C	Visc. 0° C	Visc. 20° C	Visc. 40° C	Kg
28.H10-015	15	0...+120	17000	11000	9500	?
28.H10-100	100	0...+120	17000	11000	9500	?
28.H10-1L	1000	0...+120	17000	11000	9500	0.858

Dimethyl type silicon oil rarely used as lubricant.

Application : used as bathing solutions or as water resistant agents due to their hydrophobic properties.

This oil is used as water resistant product and anti-vibration agent.

Colourless aspect.



Moebius Silicone I-31-B

MSA	ml	Temp. ° C	Visc. 0° C	Visc. 20° C	Visc. 40° C	Kg
28.I31-B-1L	1000	-35...+200	1500	500	210	?

Low viscosity silicone oil, exhibiting a good lubricity with respect to standard silicone oils. This lubricant exhibits exceptional stability and an excellent phase separation with regards to water. It is ideal for high temperature applications requiring sufficient lubricity.

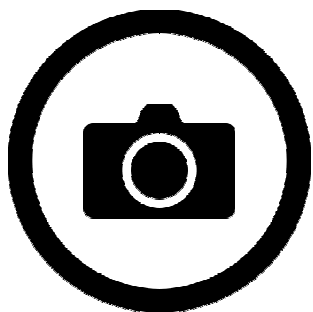

MSA	ml	Temp. ° C	Visc. 0° C	Visc. 20° C	Visc. 40° C	Kg
28.I4-100	100	-35...+200	3100	1000	405	?

Rather viscous silicone oil, exhibiting good lubricity with respect to silicone standard oils. This lubricant exhibits exceptional stability and an excellent phase separation with regards to water. It is ideal for high temperature applications requiring sufficient lubricity.

Light green aspect.

Moebius Silicone I-4



MSA	ml	Temp. ° C	Visc. 0° C	Visc. 20° C	Visc. 40° C	Kg
28.TH7-002	2	-30...+110	440	290	198	0.030

This product is a mixture of polysiloxanes. With moderate to low lubricity, it is ideally suited for the lubrication of plastics.

This oil has an excellent stability at high and low temperatures as well as to oxidation.

Colourless aspect.

Moebius Silicone TH7-SC

Natural greases for watchmaking and micromechanics.

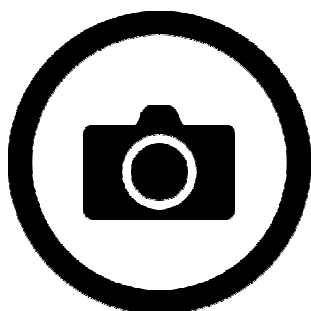

MSA	ml	Temp. ° C	Visc. 40° C	Visc. 50° C	Visc. 60° C	Visc. 80° C	Kg
28.8200-015	15	-40...+80	Solid	30	20	13	?
28.8200-050	50	-40...+80	Solid	30	20	13	0.130
28.8200-1L	1000	-40...+80	Solid	30	20	13	1.410

Very soft natural grease with important thixotropic properties. With vegetable oils as additive, it is ideal for the lubrication of springs, friction of large surfaces, slow mobiles and ball bearings.

Fusible, it can be used hot for hardening lubrication.

Cloudy yellow aspect.

Moebius 8200

8200-FL

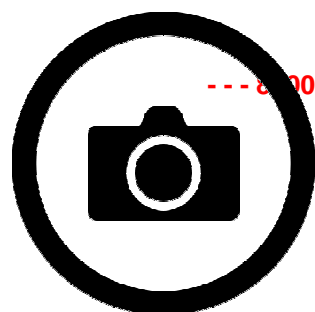

--- 8200-FL fluorescent

MSA	ml	Temp. ° C	Visc. 40° C	Visc. 50° C	Visc. 60° C	Visc. 80° C	Kg
28.8200-015FL	15	-40...+80	Solid	30	20	13	?
28.8200-1FL	1000	-40...+80	Solid	30	20	13	1.410

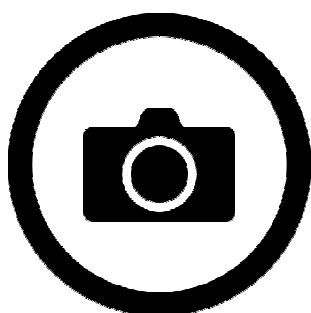

MSA	ml	Temp. ° C	Visc. 40° C	Visc. 60° C	Visc. 80° C	Kg
28.8201-015	15	-40...+80	Solid	22	13	?
28.8201-050	50	-40...+80	Solid	22	13	0.150

Very soft natural grease with remarkable thixotropic properties. Can be used in molten state. Vegetable oils as additive provide it excellent lubricity as well as performance. The addition of molybdenum disulphide (MoS₂) further enhances its lubricity and improves its resistance to pressure.

Black aspect.

Moebius 8201

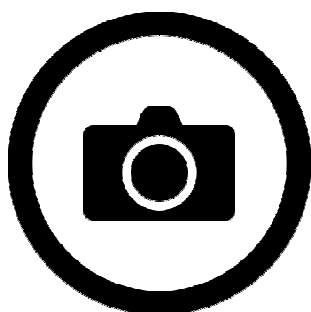

MSA	ml	Temp. ° C	Visc. 20° C	Visc. 40° C	Visc. 60° C	Kg
28.8203-015	15	-40...+80	210	-	-	?
28.8203-050	50	-40...+80	210	-	-	?

Thixotropic grease with a gelatinous consistency. With vegetable oils as additive, it offers a good lubricating power and a very good grip. It is ideal for bearings and applications submitted to moderate to large pressures. Not to be used hot.

Red aspect.

Moebius 8203

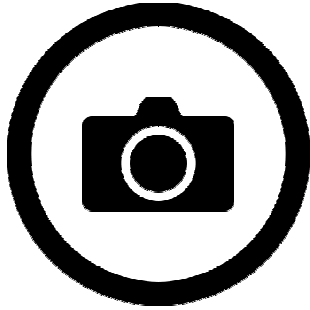

Moebius 8207

MSA	ml	Visc. 40° C	Visc. 60° C	Visc. 80° C	Kg
28.8207-015	15	Solid	20	13	?
28.8207-050	50	Solid	20	13	0.140

Very flexible and thixotropic classic grease. The vegetable oils used as an additive give it a very good lubricating power. The addition of graphite enhances its lubricity and its resistance to pressure.

Black aspect.

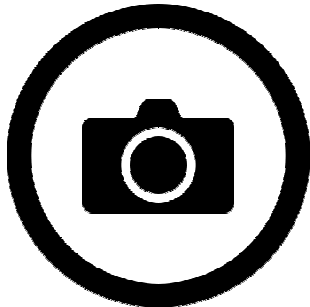

Moebius 8212



--- 8212-SC colourfree

MSA	ml	Temp. ° C	Visc. 20° C	Visc. 40° C	Visc. 60° C	Kg
28.8212-015	15	-40...+80	200	-	-	?

Soft grease (Glissalube B). The vegetable oils used as additive give it a good lubricating power. Developed for the lubrication of barrel drums, it provides moderate braking.

Specially recommended for aluminium barrel walls.

Red aspect.

8212-SC

MSA	ml	Temp. ° C	Visc. 20° C	Visc. 40° C	Visc. 60° C	Kg
28.8212-50S	50	-40...+80	200	-	-	0.160

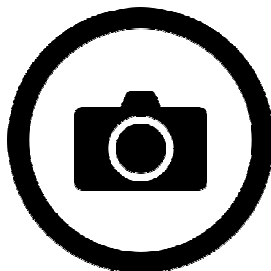

Moebius 8213

MSA	ml	Temp. ° C	Visc. 20° C	Visc. 40° C	Visc. 60° C	Kg
28.8213-015	15	-40...+80	205	-	-	?

Hard grease (Glissalube A). The vegetable oils used as an additive give it a good lubricating power. Developed for the lubrication of barrel drums, it provides effective braking.

Specially recommended for brass barrel walls.

Orange aspect.

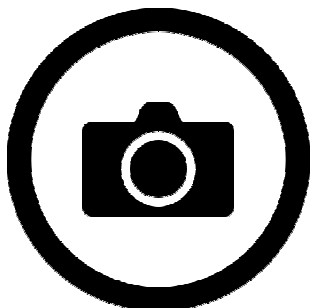

Moebius 8217

MSA	ml	Temp. ° C	Visc. 20° C	Visc. 40° C	Visc. 60° C	Kg
28.8217-015	15	-40...+80	-	-	-	?

Very soft grease (Glissalube 20) which has a good lubricity. Developed for the lubrication of barrel drums, it assures efficient braking.

This grease is recommended for the lubrication of all types of barrels.

Brown aspect.



Moebius 8300

MSA	ml	Temp. ° C	Visc. 40° C	Visc. 60° C	Visc. 80° C	Kg
28.8300-015	15	-40...+80	Solid	-	11	?
28.8300-050	50	-40...+80	Solid	-	11	0.130
28.8300-1L	1000	-40...+80	Solid	-	11	1.410

Soft grease with notable thixotropic properties. With vegetable oils as additive, this grease has a very good lubricating power and is specially recommended for springs and winder functions or any other applications subject to heavy friction.

Colourless-yellowish aspect.



--- 8300-FL fluorescent

8300-FL

MSA	ml	Temp. ° C	Visc. 40° C	Visc. 60° C	Visc. 80° C	Kg
28.8300-015F	15	-40...+80	Solid	-	11	?



Moebius 8301

MSA	ml	Temp. ° C	Visc. 40° C	Visc. 60° C	Visc. 80° C	Kg
28.8301-015	15	-40...+80	Solid	-	11	?
28.8301-1L	1000	-40...+80	Solid	-	11	?

Hard grease, slightly thixotropic. With vegetable oils as additive, as well as graphite as a solid additive, this grease has a very good lubricating properties and a good resistance to pressure.

With its excellent grip, this grease is recommended for applications subject to heavy friction.

Black aspect.



Moebius 8302

MSA	ml	Temp. ° C	Visc. 40° C	Visc. 60° C	Visc. 80° C	Kg
28.8302-015	15	-40...+80	Solid	-	14	?

Hard grease, slightly thixotropic. With vegetable oils as additive, as well as molybdenum disulphide graphite (MoS₂) as a solid additive, this grease has a very good lubricating properties and a good resistance to pressure.

With its excellent grip, this grease is recommended for applications subject to heavy pressure.

Grey-black aspect.

Synthetic greases for watchmaking and micromechanics.



Moebius 9415

MSA	ml	Temp. ° C	Visc. 20° C	Kg
28.9415-002	2	-30...+80	110	0.016
28.9415-010	10	-30...+80	110	0.038
28.9415-100	100	-30...+80	110	0.370

100% synthetic soft thixotropic grease presenting an excellent stability and a very good lubricity allowing effective wear reduction. Specially developed for the lubrication of the escapement, it allows the formation of an efficient lubrication film. For micromechanics, it is used in the following areas : miniature ball bearings, step-by-step motors, high frequencies, synchronies, etc. *Yellow aspect.*

9415-FL

--- 9415-FL fluorescent



MSA	ml	Temp. ° C	Visc. 20° C	Kg
28.9415-2F	2	-30...+80	110	-
28.9415-01F	10	-30...+80	110	0.054



Moebius 9500

MSA	ml	Temp. ° C	Visc. 20° C	Kg
28.9500-010	10	-20...+100	1350	-

100% synthetic firm braking grease based on a polyol ester, developed for the lubrication of the barrel. With a very good crush-ing stability and with special additives, it presents an excellent grip and allows to protect surfaces against wear. Suitable for appli-cations at high pressure. Grease particularly adapted to the lubrication of barrel drums. *Black aspect.*



Moebius 9501

- * Syringe
- ** Bottle

MSA	ml	Temp. ° C	Visc. 20° C	Kg
28.9501-010-B **	10	-30...+80	176	0.053
28.9501-010-S *	10	-30...+80	176	0.021
28.9501-050 **	50	-30...+80	176	0.064

100% synthetic and thixotropic soft grease, developed to resolve friction problems like time setting, winding and calendar mechanisms, rotating bezels of diving watches and other frictions between steels. The base is a mixture of synthetic oils of high stability, acquiring the necessary consistency of a grease by adding an Aerosil. Suitable for medium loads for a wide range of applications.

Blue aspect.

9501-R



9501-R rouge

MSA	ml	Temp. ° C	Visc. 20° C	Kg
28.9501-R-010 *	10	-30...+80	176	0.021

9501-SC



9501-FL fluorescent

MSA	ml	Temp. ° C	Visc. 20° C	Kg
28.9501-10S *	10	-30...+80	176	0.022

9501-FL

MSA	ml	Temp. ° C	Visc. 20° C	Kg
28.9501-01F-B **	10	-30...+80	176	0.021
28.9501-01F-S *	10	-30...+80	176	0.021
28.9501-05F **	50	-30...+80	176	0.064



Moebius 9520 fluorescent

MSA	ml	Temp. ° C	Visc. 20° C	Kg
28.9520-10F	10	-20...+100	305	-

Partially synthetic soft grease with very good lubricity under high to very high pressure conditions. It is formulated with a high performance solid lubricant to significantly reduce wear.

Suitable for a wide range of applications (cannon-pinion friction, time setting friction, winding mechanism, calendar, date, chronograph).

The addition of a fluorescent tracer makes it possible to visualize the presence of small amounts of grease under UV illumination.

Black aspect.



Moebius 9550

MSA	ml	Temp. ° C	Visc. 20° C	Kg
28.9550-010	10	-20...+100	1350	-

100% synthetic soft grease with a high crush stability presenting a very good lubricity under high pressure conditions allowing to reduce notably the wear. This grease is made with a lithium-based soap.

Suitable for a wide range of applications : time setting friction, winding mechanism, calendar and chronograph.

Red aspect.



Moebius 9504
* Syringe

MSA	ml	Temp. ° C	Visc. 20° C	Kg
28.9504-005	5	-20...+100	305	0.047
28.9504-10	10	-20...+100	305	0.057
28.9504-10-S *	10	-20...+100	305	0.024
28.9504-50	50	-20...+100	305	0.125

100% synthetic soft grease with a high crush stability presenting a very good lubricity under high pressure conditions allowing to reduce notably the wear. Grease 9501 is the basic component.

The addition of a grease based on a metal soap increases the consistency and improves adhesion. A neutral additive provides excellent high-pressure resistance and guarantees a good reduction in wear.

Suitable for any metal/metal friction of medium and high pressures.

Applications : time setting friction, winding mechanism, calendar and chronograph.

Light blue aspect.

9504-SC



--- 9504-SC colourless

MSA	ml	Temp. ° C	Visc. 20° C	Kg
28.9504-05S	5	-20...+100	305	0.047
28.9504-10S	10	-20...+100	305	0.057
28.9504-10S-S *	10	-20...+100	305	0.020
28.9504-50S	50	-20...+100	305	0.125

9504-FL



--- 9504-FL fluorescent

MSA	ml	Temp. ° C	Visc. 20° C	Kg
28.9504-05F	5	-20...+100	305	0.047
28.9504-10F	10	-20...+100	305	0.057
28.9504-50F	50	-20...+100	305	0.125

Waterproof silicon greases.



Moebius 8513

MSA	ml	Temp. ° C	Visc. 20° C	Kg
28.8513-010	10	-60...+150	Solid	0.015
28.8513-050	50	-60...+150	Solid	0.067
28.8513-100	100	-60...+150	Solid	0.145
28.8513-200	200	-60...+150	Solid	0.320

Firm sealant grease. Based on its chemical nature, this silicone grease exhibits very high inertia and resistance to external aggressions such as UV light or oxidative stress.

Moreover, this product has very good demixing properties for water. Ideal for repairing and control of waterproof watches.

Transparent white aspect.



MSA	Contents	Kg
28.002	2 g	0.030

Box with grease Moebius® 8513.



Moebius 8516

MSA	ml	Temp. ° C	Visc. 20° C	Kg
28.8516-10	10	-60...+120	Soft	0.015
28.8516-50	50	-60...+120	Soft	0.072
28.8516-200	200	-60...+120	Soft	0.550

Sealing grease softer than 8513. Based on its chemical nature, this silicone grease exhibits very high inertia and resistance to external aggressions such as UV light or oxidative stress.

Moreover, this product has very good demixing properties for water. Ideal for repairing and control of waterproof watches.

Transparent white aspect.

Moebius® Quartz Oil.



MSA	ml	Temp. ° C	Visc. 0° C	Visc. 20° C	Visc. 40° C	Kg
28.9000-002	2	-35...+65	395	100	35	0.010

Universal synthetic lubricant for quartz analogue watches. Suitable for plastic like polyacetal (Delrin®), polyamides, polycarbonates. Very adherent and doesn't spread out in normal use conditions. *Red aspect*

Moebius Quartz Oil 9000

Moebius® Microgliss Oils.

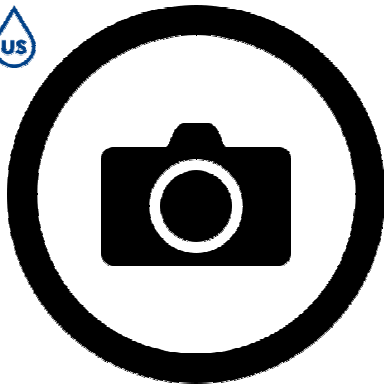

MSA	ml	Temp. ° C	Visc. 0° C	Visc. 20° C	Visc. 40° C	Kg
28.K6-100	100	-5...+120	2600	450	125	?

This Microgliss oil has both a very good lubricity and resistance to pressure. It includes as additive a very powerful anticorrosive agent. This oil is ideal for applications with severe corrosion risks. This product is recommended for dip lubrication.

Moebius Microgliss K-6



MSA	ml	Temp. ° C	Visc. 0° C	Visc. 20° C	Visc. 40° C	Kg
28.K7-1L	1000	-15...+100	630	130	42	1.630

This Microgliss oil has a very good lubricating power. Formulated with a wetting agent as well as an anti-corrosive agent, this product spreads perfectly. It is recommended for dip lubrication for applications with significant corrosion risk.

Moebius Microgliss K-7

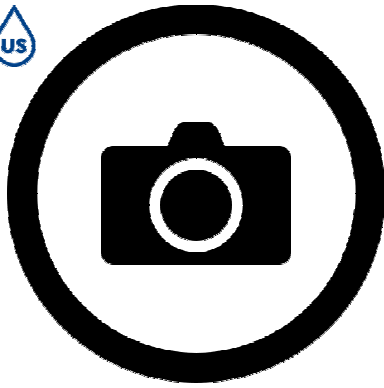

Moebius Microgliss L5

MSA	ml	Temp. ° C	Visc. 0° C	Visc. 20° C	Visc. 40° C	Kg
28.L5-100	100	-3...+80	8300	1200	310	?
28.L5-1L	1000	-3...+80	8300	1200	310	1.630

Lubricant based on refined mineral oils and vegetal oils.
 With a very good lubricating power and remarkable grip, this product has been specially developed for applications with a significant corrosion risk and requiring good lubricity. Diluted in an alkane solvent, this oil is ideal for dip lubrication.

Moebius® oil and grease kits.



MSA	Packaging size	Kg
28.QUA2017	200 x 75 x 30 mm	0.350

Lubricating kit for quartz watches.

- Contents :*
- 2 ml oil 9014
 - 2 ml oil 9104-SC
 - 5 ml grease 8212-SC
 - 5 ml grease 8302
 - 5 ml grease 9501-SC.



MSA	Packaging size	Kg
28.MEC2017	200 x 75 x 30 mm	0.350

Lubricating kit for mechanical watches.

- Contents :*
- 2 ml oil 9010
 - 5 ml oil 9104
 - 2 ml grease 9415
 - 5 ml grease 9501
 - 5 ml grease 9504.

Lubeta oils.



MSA	ml	Kg
28.V105-010	10	0.052
28.V105-100	100	0.197

Ready-to-use solution Lubeta V105 for dip lubrication. Composed of a solid lubricant type fatty acid, this allows a homogeneous deposition of a thin lubricating film. This product is typically recommended for the lubrication of inversion wheels and paws. Ideal for after-sales services.



MSA	ml	Kg
28.V106-010	10	0.052
28.V106-100	100	0.180

Ready-to-use solution Lubeta V106 for dip lubrication. This allows homogeneous deposition of a thin film of lubricant. This product is typically recommended for lubrication of ball bearings and springs. Ideal for after-sales services.

UV lamps.



MSA	Visc. 0° C	Kg
00.682	Ø 13 x 125 mm	0.033

UV lamp (pen light) for controlling fluorescent oils. Light colour : blue/violet. 395 Nm.

Works with 2 AAA batteries (not included).



MSA	Visc. 0° C	Kg
00.683	Ø 25 x 140 mm	0.215

UV flashlight for controlling fluorescent oils and detecting dust. Light colour : white. 365 Nm.

Delivered with 1 rechargeable battery 18650 (2000 mAh - 3.7 V) and 1 charger.

LRCB synthetic oils and greases for the watchmaking industry.



MSA	Packaging size	Kg
28.211	200 x 73 x 32 mm	0.140

Kit of 5 synthetic oils and greases (5 small bottles of 5 ml).

Contents :

- Oil MSA28.210-005
 - Oil MSA28.275-005
 - Grease MSA28.515-005
 - Grease MSA28.620-005
 - Grease MSA28.735-005.
- Delivered in 1 plastic box.



MSA	ml	Temp. ° C	Visc. 20° C	Kg
28.210-005	5	...-30	140	0.011

Fine oil for bearing of balance staff and pallet fork wheel. Contains a fluorescent additive. Cyan colour.

See kit MSA28.211.



MSA	ml	Visc. 20° C	Kg
28.275-005	5	1300	0.012

Thick oil for bearing of train wheel axle and barrel arbor. Red color.

See kit MSA28.211.



MSA	ml	Kg
28.515-005	5	0.012

Thixotropic grease for escapement. Contains a fluorescent additive. Yellow colour.

See kit MSA28.211.



MSA	ml	Kg
28.620-005	5	0.012

Grease for mechanism and cannon pinion based on microsilica. Contains a fluorescent additive.

For ferrous alloys, not suitable for copper alloys.

Red color.

See kit MSA28.211.



MSA	ml	Kg
28.735-005	5	0.013

Thick grease for mechanism based on PTFE. Can be used in some barrels. Suitable for ferrous and copper alloys.

Opaque white colour.

See kit MSA28.211.



MSA	ml	Visc. 20° C	Kg
28.272-005	5	500	0.012
28.273-005	5	750	0.012
28.274-005	5	1000	0.012

Thick oil for bearing of train wheel axle and barrel arbor.
Red color.

SEIKO® oil.

SEIKO



MSA	ml	Kg
28.103	2	0.010

SEIKO® AO-3 oil for train wheels and escapements.

SEIKO® greases.

SEIKO



MSA	Contents	Size	Kg
28.104	4 g	Ø 36 x 18 mm	0.014

SEIKO® TSF-451 silicon grease.

- Mainly used in the repair and control of waterproof watches
- Excellent lubricant with water-displacing property
- For the lubrication of crown gaskets, case backs and bezels.



MSA	Contents	Kg
28.004	2 g	0.030

Box with grease Seiko® TSF-451.

SEIKO

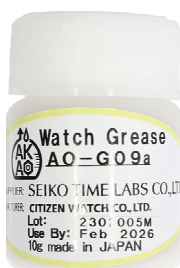

MSA	Contents	Size	Kg
28.109	10 g	Ø 30 x 45 mm	0.036

Grease Seiko® AO-G09a.

- Long service life with a durability of over 20 years
- High resistance to corrosion
- Highly versatile : suitable for both engineering plastics and metals.

LA JURASSIENNE® oil.



MSA	ml	Size	Kg
28.J.0100	100	Ø 45 x 105 mm	0.154

LA JURASSIENNE® mineral oil for wall clocks.
 - Severely refined and compatible with strong oxidants
 - Temperature of auto-inflammation at 200° C
 - Stable product in usual stocking temperatures, manipulation and use.

Lubristyl® precision oil pen.



MSA	ml	Temp. ° C	Kg
17.210	Ø 13 x 155 mm	6 cc	0.028

Lubristyl® precision oil pen, pen shape.
 Drop by drop lubricant dispenses thanks to the needle pump. Possibility to easily re-absorb the extra oil by briefly and rapidly pushing the needle.
Delivered with 6 cc oil.

Spare part :

MSA	Item	Kg
17.210-100	Oil refill, 100 ml	0.113



FOMBLIN® UT18 grease.



MSA	Colour	Packaging	Size	Kg
28.UT18-020 (1)	White	Pot of 20 g	Ø 34 x 40.5 mm	0.025
28.UT18-100 (2)	White	Tube of 100 g	Ø 30 x 145 mm	0.115

FOMBLIN® UT18 grease. Advantages :

- Excellent lubricant for multiple uses
- Compatible with all sorts of material like plastic, metals, glass, etc.
- It resists to oxidation and other chemical products
- Used in watchmaking for greasing gaskets
- Temperatures use range : from -30° C to +250° C.



MSA	Contents	Kg
28.001	2 g	0.030

Box with grease Fomblin® UT18.

SILCON-7® grease.



MSA	Packaging	Size	Kg
28.652	Tube of 10 g	Ø 12 x 56 mm	0.012

SILCON-7® waterproofing grease.

- For watch cases
- It stops gaskets from drying and encrusting in the thread.



MSA	Contents	Kg
28.000	2 g	0.030

Box with grease Silicon-7®.

BLASOLUBE® grease.



MSA) then 'Type'when 300 then '	Packaging	Kg
28.301	302	Tube of 250 g	0.277

BLASOLUBE® 302 universal lubricant grease for a very wide-ranging use.
 - Soft/half-hard consistency
 - Temperatures use range : from -20° C up to +150/200° C.



MSA) then 'Type'when 300 then '	Packaging	Kg
28.307	301	Tube of 400 g	0.460

BLASOLUBE® 301 universal lubricant grease for a very wide-ranging use.
 - Soft consistency
 - Temperatures use range : from -30° C up to +120/150° C.

CHRONOGREASE KLÜBER P125® grease.



MSA	Packaging	Size	Kg
28.102	Pot of 5 g	Ø 22.5 x 31 mm	0.008

CHRONOGREASE KLÜBER P125® grease.
 Recommended by ETA SA for greasing mainsprings (calibres 7750, A07111, etc.).

LUBRIBOX : box with 2 foam cushions impregnated with silicone grease allowing to lubricate O-Ring gaskets up to Ø 60 mm.



MSA	Contents	Kg
28.000	2 g	0.030

Box with grease Silicon-7®.



MSA	Contents	Kg
28.001	2 g	0.030

Box with grease Fomblin® UT18.



MSA	Contents	Kg
28.002	2 g	0.030

Box with grease Moebius® 8513.



MSA	Contents	Kg
28.003	2 g	0.030

Box with grease Molykote® 111.



MSA	Contents	Kg
28.004	2 g	0.030

Box with grease Seiko® TSF-451.



MSA	Contents	Kg
28.220		0.028

Box without grease.

JISMAA® lubricants.



MSA	Colour	Packaging	Size	Kg
28.200	Blue	Tube of 7 g	85 x 20 x 15 mm	0.009
28.205	Green	Tube of 7 g	85 x 20 x 15 mm	0.009

JISMAA® synthetic lubricant entirely mineral, specially recommended for precision instruments, measuring instruments, counters, quartz movements, optical instruments, etc. Its deterioration, spreading and evaporation are nil. This lubricant can accept extreme temperature variations (-50° C to +100° C), big centrifugal force (30,000 rpm) and strong friction. No oxidation.

Recommended use :
 - BLUE for steel/steel (alloys frictions, iron alloy carbon/Mo/steel/Cr)
 - GREEN for steel/brass (alloys frictions, iron alloy copper Cu/Be/Ni).
 Recommended use with JISMAA® oilers illustrated in chapter 17 (MSA17.050...17.052 and MSA17.060...17.063).

MOLYKOTE® lubricants.



MSA	Colour	Packaging	Size	Kg
28.303	White	Tube of 100 g	Ø 35.5 x 170 mm	0.110

MOLYKOTE® 111 waterproofing paste based on silicone grease.

Advantages :

- Excellent water resistance, even see water
- Good resistance to most chemical products
- Low volatility
- The purpose is to avoid crowns and tubes gaskets sticking to metal
- Temperatures use range : from -40° C up to +200° C.



MSA	Contents	Kg
28.003	2 g	0.030

Box with grease Molykote® 111.



MSA	Colour	Packaging	Size	Kg
28.300	White	Tube of 50 g	Ø 35 x 130 mm	0.077
28.308	White	Box of 250 g	Ø 100 x 50 mm	0.280

MOLYKOTE® DX white consistent paste made of lithium grease.

- Very high load capacity
- Reduces friction and wearing
- Very good resistance to the washing out
- Protection against cold temperature soldering
- Good protection against oxidation and excellent protection against contact corrosion. It reduces incidents of grinding and seizing
- Temperatures use range : from -25° C to +125° C.

KT-22® lubricants.

MSA	Packaging	Size	Kg
28.651	Pot of 12 g	Ø 34 x 32 mm	0.017

KT-22® lubricant for multiple uses.
For greasing gear trains on watches and various instruments, waterproofing crowns, pushers and case backs gaskets.

Loosening lubricant.

MSA	Packaging	Size	Kg
28.654	Syringe of 6 cc	Ø 15 x 155 mm	0.015

High-powered loosening lubricant for screws.

SUPER LUBE® multi-use Syncolon® lubricant.

Main features :

- The product is 100% synthetic and biodegradable / No petroleum and no silicon component
- Non-corrosive and non oxidable / Better lubrication thanks to PTFE suspension particles
- Totally neutral on plastic, paints, clothes, rubber or wood / It doesn't stain
- 100% hot, cold and saltwater resistant / It doesn't evaporate / Without odour
- Dielectric and prevent seizure / It doesn't dry / Efficient between -40° C and +232° C.



MSA	Packaging	Size	Kg
28.SL007	Pen 7 g (in blister)	Ø 15 x 120 mm	0.022



MSA	Packaging	Size	Kg
28.SL012	Tube of 12 g (in blister)	Ø 25 x 110 mm	0.025

LUBRICANTS



MSA	Packaging	Size	Kg
28.SL085	Tube of 85 g (in blister)	Ø 55 x 145 mm	0.110



MSA	Packaging	Size	Kg
28.SL300	Spray 300 ml	Ø 65 x 200 mm	0.380



MSA	Packaging	Size	Kg
28.SL400	Pot 400 g	Ø 100 x 95 mm	0.455



MSA	Packaging	Size	Kg
28.SL-1L	1 litre with vaporizer	105 x 60 x 225 mm	0.875

Epilamination is an essential surface treatment for lubrication. This treatment is intended to lower the surface tension of a material, thus preventing the spreading of lubricants on the treated surface. It provides the highest possible degree of safety to precision mechanical instruments by guaranteeing effective and long-lasting lubrication.

EPISURF-Neo® Epilames.



MSA	ml	Boiling point	Kg
28.405-020	20	76° C	0.083
28.405-050	50	76° C	0.151
28.405-100	100	76° C	0.265
28.405-1L	1000	76° C	2.360

Episurf-Neo® is a high-performance epilame. Episurf-Neo® is fixed in a self-assembled monolayer of constant thickness on all surfaces used in watchmaking. Its properties make it a reference epilame for watch parts, in production in watch manufacturers or in after-sales service workshops, in Switzerland and all over the world. Episurf-Neo® is an invisible epilame, of nanometric thickness, whose application process is fast and reproducible. The performance of Episurf-Neo® allows an effective, durable and resistant epilame for many wash cycles. Episurf-Neo® is an environmentally friendly product that complies with European and Swiss regulations.

Ready for use solution.

Technical and environmental data :

<i>Composition</i>	<i>Perfluoropolyether phosphonate</i>
<i>Diluent</i>	<i>Hydro fluoro olefin</i>
<i>Density at 25° C</i>	<i>1.58</i>
<i>Flash point</i>	<i>110° C</i>
<i>Freezing point</i>	<i>< -90° C</i>
<i>VOC</i>	<i>0 %</i>
<i>Do not deplete the ozone layer</i>	<i>0 (ODP)</i>
<i>Global warming potential</i>	<i>2.5</i>
<i>Surface tension</i>	<i>15 +/- 2 dyn.cm-1</i>
<i>Atmospheric lifetime</i>	<i><10 days</i>

MOEBIUS® Epilames.

The Fixodrop epilame is successfully used in the following application areas:

- Hydrophobic and oleophobic surface treatment (epilame) for mechanisms, electronic devices and mechanical parts
- Precision micromechanics (watches, timers, measuring devices, tools, etc.)
- On-board instrumentation and counters (automotive, aeronautical, naval, etc.)
- Cameras and optical instruments
- General mechanics (office machines, fans, etc.).



Moebius Fixodrop BS

MSA	ml	Type	Boiling point	Kg
28.8980-100	100	BS	110° C	0.265
28.8980-1L	1000	BS	110° C	1.680
28.8981-010	10	BS-10	110° C	-
28.8981-100	100	BS-10	110° C	0.295
28.8981-1L	1000	BS-10	110° C	1.680
28.8982-1L	1000	BS-20	110° C	1.680

Fixodrop ES/BS is a modern epilame, developed by MOEBIUS, based on fluorinated synthetic resins, diluted in a solvent which meets current ecological standards.

- 8980 : concentrated solution, may only be dissolved with solvent MSA28.5700-1L
- 8981 : ready-to-use solution
- 8982 : ready-to-use solution recommended only at a production level with excellent working conditions and regular checks.

Technical features :

<i>Nano metric film</i>	<i>Invisible</i>
<i>Active material</i>	<i>Fluorinated polyester</i>
<i>Diluent</i>	<i>Ecosolv (MSA28.5700-1L)</i>
<i>Density at 20° C</i>	<i>1.59 g/ml</i>
<i>Boiling point</i>	<i>110° C</i>
<i>Flash point</i>	<i>Non-flammable</i>
<i>Toxicity</i>	<i>Non toxic</i>
<i>Ozone depletion potential</i>	<i>0 (ODP)</i>
<i>Atmospheric life time</i>	<i>< 10 days</i>
<i>Thickness epilame film</i>	<i>Approx. 3 - 5 nm</i>
<i>Superficial tension</i>	<i>Approx. 20 mN/m</i>
<i>Stability epilame film</i>	<i>Until 150° C</i>
<i>Compatibility</i>	<i>All types of materials</i>



Moebius Fixodrop W

MSA	ml	Type	Boiling point	Kg
28.8970-1L	1000	W	100° C	1.680
28.8971-1L	1000	W-10	100° C	1.680

Fixodrop W is an aqueous economical epilame. The active substance is a high activity fluorine compo-nent. This washable epilame can be removed after a simple wash with an aqueous or alcoholic solution.

- 8970 : concentrated solution. Before dilution, the concentrate must be shaken vigorously, also during partial sampling. Any empty bottle should be rinsed
- 8971 : ready-to-use solution.

Technical features :

Nano metric film	Invisible
Active material	Fluorinated polymer
Diluent	Demineralised water
Density at 20° C	1.00 g/ml
Boiling point	100° C
Flash point	Non-flammable
Toxicity	Non toxic
Atmospheric life time	< 10 days
Thickness epilame film	Approx. 3 - 5 nm
Superficial tension	Approx. 16 mN/m
Stability of the polymer	Until 150° C
Compatibility	All types of materials (ruby, steel, brass, etc.)



Moebius Fixodrop WR-S

MSA	ml	Type	Boiling point	Kg
28.7060-100	100	WR-S	110 ° C	?
28.7061-100	100	WR-S	110 ° C	?
28.7061-1L	1000	WR-S	110 ° C	?
28.7062-100	100	WR-S	110 ° C	?
28.7062-1L	1000	WR-S	110 ° C	?

Fixodrop ES/WR-S are the first series of our "Wash Resistance" (WR) epilams that have been specifically developed to improve the washing resistance of standard materials (steel, ruby, copper, etc.). These epilams can be applied to all materials, but they will be the most effective on these standard materials for which they have excellent resistance to washing.

- 7060 : concentrated solution, may only be dissolved with solvent MSA28.5700-1L
- 7061 : ready-to-use solution
- 7062 : ready-to-use solution recommended only at a production level with excellent working conditions and regular checks.

Technical features :

Nano metric film	Invisible
Active material	Fluorinated polymer
Diluent	Ecosolv (MSA28.5700-1L)
Density at 20° C	1.59 g/ml
Boiling point	110° C
Flash point	Non-flammable
Toxicity	Non toxic
Ozone depletion potential	0 (ODP)
Atmospheric life time	< 10 days
Thickness epilame film	Approx. 3 - 5 nm
Superficial tension	Approx. 20 mN/m
Stability epilame film	Until 150° C
Compatibility	All types of materials



Moebius Fixodrop WR-P

MSA	ml	Type	Boiling point	Kg
28.7070-100	100	WR-P	110° C	?
28.7071-100	100	WR-P	110° C	?
28.7071-1L	1000	WR-P	110° C	?
28.7072-100	100	WR-P	110° C	?
28.7072-1L	1000	WR-P	110° C	?

Fixodrop ES/WR-P are the second series of our "Wash Resistance" (WR) epilams that have been specifically developed to improve the washing resistance of special or precious materials (gold, rhodium-plated, nickel, DLC, etc).

These epilams can be applied to all materials, but they will be the most effective on these standard materials for which they have excellent resistance to washing.

- 7070 : concentrated solution, may only be dissolved with solvent MSA28.5700-1L
- 7071 : ready-to-use solution
- 7072 : ready-to-use solution recommended only at a production level with excellent working conditions and regular checks.

Technical features :

<i>Nano metric film</i>	<i>Invisible</i>
<i>Active material</i>	<i>Fluorinated polymer</i>
<i>Diluent</i>	<i>Ecosolv (MSA28.5700-1L)</i>
<i>Density at 20° C</i>	<i>1.59 g/ml</i>
<i>Boiling point</i>	<i>110° C</i>
<i>Flash point</i>	<i>Non-flammable</i>
<i>Toxicity</i>	<i>Non toxic</i>
<i>Ozone depletion potential</i>	<i>0 (ODP)</i>
<i>Atmospheric life time</i>	<i>< 10 days</i>
<i>Thickness epilame film</i>	<i>Approx. 3 - 5 nm</i>
<i>Superficial tension</i>	<i>Approx. 20 mN/m</i>
<i>Stability epilame film</i>	<i>Until 150° C</i>
<i>Compatibility</i>	<i>All types of materials</i>



Moebius solvent for Fixodrop

MSA	ml	Visc. 20° C	Kg
28.5700-1L	1000	0.83	1.620

EcoSolv is suitable for replacing PFCs, PFPEs, HFEs, HFCs and HCFSs in specialized applications. The favorable viscosity and density characteristics of this product allow superior cleaning as well as performances as carrier fluid.

- Solvent for diluting Fixodrop epilames MSA28.7060-250, MSA28.7070-1L et MSA28.8980-x (10% of concentrate solution / 90% of solvent)
- Cleaning agent
- Coating agent (carrier fluid) for fluorinated materials.

Technical features :

<i>Solvent class</i>	<i>Hydrofluoroolefin</i>
<i>Density at 20° C</i>	<i>1.59 g/ml</i>
<i>Boiling point</i>	<i>110° C</i>
<i>Freezing point</i>	<i>< -90° C</i>
<i>Thermal conductivity</i>	<i>0.065 W/m-K</i>
<i>Surface tension</i>	<i>18 dyne/cm</i>
<i>Vapour pressure</i>	<i>2.9 kPa</i>
<i>Heat of vaporization</i>	<i>115 kJ/kg</i>
<i>Flammability point</i>	<i>Non-flammable</i>
<i>Toxicity</i>	<i>Non toxic</i>
<i>Ozone depletion potential</i>	<i>0 (ODP)</i>
<i>Atmospheric life time</i>	<i>< 10 days</i>

Test oils to control the quality of the epilame.



Moebius test oil

MSA	No.	ml	Temp. ° C	Visc. 0° C	Visc. 20° C	Visc. 40° C	Kg
28.9701-005	1	5	-20...+1C	150	40	18	?
28.9702-005	2	5	-40...+1C	59	55	39	?
28.9703-005	3	5	-40...+1C	99	56	35	?
28.9704-005	4	5	-30...+1C	145	48	21	?
28.9705-005	5	5	-30...+9C	162	44	19	?
28.9706-005	6	5	-20...+8C	233	63	21	?

There are 6 test oils to control the quality of the epilame (Fixodrop) deposited on a surface.

No. 1 (colourless) : this fluorinated oil is a positive control to confirm that the surface is epilamated. A spreading of this oil confirms the presence of the epilame.

No. 2 (orange) : without epilame on the surface, this oil spreads extremely easily compared to a classic watch oil. If this oil forms a drop and does not spread entirely on the surface, this confirms the good quality of the epilame.

No. 3 (red) : without epilame on the surface, this oil spreads extremely easily compared to a classic watch oil. If this oil forms a drop and does not spread on the surface, this confirms the good quality of the epilame.

No. 4 (yellow) : without epilame on the surface, this oil spreads easily like a standard watch oil with a moderate grip would do. If this oil forms a drop and does not spread on the surface, this confirms the good quality of the epilame.

No. 5 (blue) : without epilame on the surface, this oil spreads significantly like a watch oil with very good grip would do. If this oil forms a drop and does not spread on the surface, this confirms the good quality of the epilame.

No. 6 (green) : without epilame on the surface, this oil spreads very slightly like a watch oil with an excellent grip would do. If this oil forms a drop and does not spread on the surface, this confirms the good quality of the epilame.

LRCB Epilames.



MSA	ml	Boiling point	Kg
28.8983-020	20	76° C	?
28.8983-100	100	76° C	0.245
28.8983-1L	1000	76° C	?

Epilame ECO-50 is a solution of a fluorinated compound that lowers the surface tension of watch components. The contact angle of the lubricants is increased to ensure their remain-in-place over time.

- Can be used on all metal substrates and on ruby
- Ready to use
- Non-flammable under normal conditions of use, no flash point
- Does not contain any persistent solvents as defined by Swiss and European law
- Contains no ozone-depleting solvents
- Compatible with common plastics.

Characteristics :

<i>Dry extract : 50 mg/litre</i>	<i>50 mg/litre</i>
<i>Flash point : none</i>	<i>none</i>
<i>Density : 1.43 g/cm3</i>	<i>1.43 g/cm3</i>
<i>Boiling point : 76° C</i>	<i>76° C</i>

29



Soldering station.



MSA	Voltage	Size	Kg
29.227	220 V	195 x 100 x 90 mm	0.800

Soldering station VTSS7, ideal for beginners as well as professionals.

Specifications :

- Supply : 220 V / 50 Hz
- Consumption : 50 VA maximum
- Electronic temperature setting : from 175 to 480° C.

Soldering accessories.



MSA		Ø wire	Packaging	Kg
29.615	(1)	0.71 mm	Spool of 500 g	0.520
29.616	(2)	0.71 mm	1 metre wire	0.004

Soldering wire with incorporated flux. Melting point at 179° C.



MSA	Ø braid	Packaging	Kg
29.631	0.80 mm	Spool of 1.5 metres	0.005

Desoldering braid.



MSA	Colour	Size	Kg
29.626	Metal	168 x 55 mm	0.011

Bag of 12 universal soldering rods ready to use with cleaning agent already included, for an optimal job with almost no waste. High resistant soldering on numerous metals whose melting points exceed 600° C. Neither additional scouring solution, solvent or cleaning product is necessary. The rods are used for stainless steel, cobalt-chrome and silver.



MSA	Size	Kg
29.606	135 x 95 x 13 mm	0.125

Insulating soldering plate.



MSA	Size	Kg
29.614-B	120 x 80 x 30 mm	0.112

Soft charcoal block chemically prepared for soldering. Under the flame the charcoal block turns in red and reflects the heat for more efficient soldering.



MSA	Size	Kg
29.501	155 x 100 x 75 mm	0.705

Base with 2 revolving nippers mounted on a mobile arm for holding items during soldering.



MSA	Size	Kg
29.651	Ø 68 x 152 mm	0.185

Alcohol lamp.
Delivered with a wick.

Spare part :

MSA	Item	Kg
29.651-A	Wick, length 200 mm	0.009

See chapter PERF.

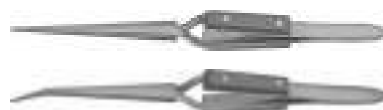

Soldering pastes.



MSA	Contents	Carats	Melting point	Size	Kg
29.611-A14	1.55 g	14	637° C 1180° F	Ø 10 x 115 mm	0.005

EASY type soldering paste in yellow gold.
Delivered in a syringe.



MSA	Contents	Carats	Melting point	Size	Kg
29.611-A18	1.55 g	18	790° C 1455° F	Ø 10 x 115 mm	0.005

EASY type soldering paste in yellow gold.
Delivered in a syringe.



MSA	Contents	Melting point	Size	Kg
29.610-A	14 g	618° C 1145° F	Ø 19 x 160 mm	0.028

EASY type SILVER soldering paste. It contains cadmium.
Delivered in a syringe.



MSA	Contents	Kg
26.623	1.5 ml	0.065

Circuit Maker.
Repairs quartz analog and digital circuitry as well as any other fine wire circuits with a minimum of time and effort.
Eliminates long drying times.
Kit includes 1 bottle with 1.5 ml fluid and an applicator.

32



BEADING TOOLS

32 - 2

BEADING TOOLS PLATES / MILLGRAIN TOOLS

32 - 4

MAILLEFER® "Swiss Made" beading tools.



MSA	Packaging size	Kg
32.001-901	56 x 56 x 76 mm	0.088

Assortment of 12 SWISS beading tools.

- Contents :*
- 1 storage box
 - 1 wooden handle
 - 12 beading tools no. 1...12.



MSA	Packaging size	Kg
32.001-902	56 x 56 x 76 mm	0.116

Assortment of 23 SWISS beading tools.

- Contents :*
- 1 storage box
 - 1 wooden handle
 - 23 beading tools no. 0...22.

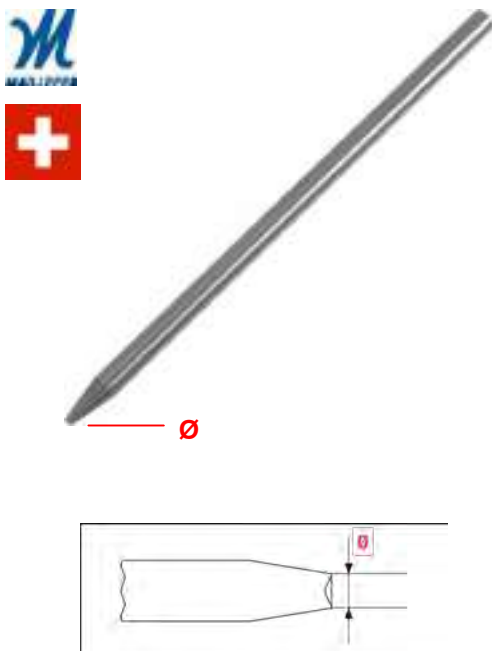

MSA	Numbers	Ø	Length x Ø	Kg
32.001-00	0	0.25 mm	60 x 2.60 mm	0.002
32.001-01	1	0.30 mm	60 x 2.60 mm	0.002
32.001-02	2	0.35 mm	60 x 2.60 mm	0.002
32.001-03	3	0.40 mm	60 x 2.60 mm	0.002
32.001-04	4	0.45 mm	60 x 2.60 mm	0.002
32.001-05	5	0.50 mm	60 x 2.60 mm	0.002
32.001-06	6	0.55 mm	60 x 2.60 mm	0.002
32.001-07	7	0.60 mm	60 x 2.60 mm	0.002
32.001-08	8	0.65 mm	60 x 2.60 mm	0.002
32.001-09	9	0.70 mm	60 x 2.60 mm	0.002
32.001-10	10	0.75 mm	60 x 2.60 mm	0.002
32.001-11	11	0.80 mm	60 x 2.60 mm	0.002
32.001-12	12	0.85 mm	60 x 2.60 mm	0.002
32.001-13	13	0.90 mm	60 x 2.60 mm	0.002
32.001-14	14	0.95 mm	60 x 2.60 mm	0.002
32.001-15	15	1.00 mm	60 x 2.60 mm	0.002
32.001-16	16	1.05 mm	60 x 2.60 mm	0.002
32.001-17	17	1.10 mm	60 x 2.60 mm	0.002
32.001-18	18	1.15 mm	60 x 2.60 mm	0.002
32.001-19	19	1.20 mm	60 x 2.60 mm	0.002
32.001-20	20	1.25 mm	60 x 2.60 mm	0.002
32.001-21	21	1.30 mm	60 x 2.60 mm	0.002
32.001-22	22	1.35 mm	60 x 2.60 mm	0.002

MAILLEFER® "Swiss Made" beading tool.

GLARDON® VALLORBE "Swiss Made" beading tools. High quality steel, hardness 64-66 HRC.



(1)



MSA	Packaging size	Kg
32.003-A	130 x 75 x 40 mm	0.145
32.003-B (1)	130 x 75 x 40 mm	0.167

Assortment of VALLORBE beading tools.

Contents MSA32.003-A :	Contents MSA32.003-B :
- 1 wooden base	- 1 wooden base
- 1 wooden handle	- 1 wooden handle
- 12 beading tools no. 2 - 4 - 5...12 - 14 - 16.	- 23 beading tools n° 00...22.

ASSORTMENT



- Regular and polished cap
- Can be used directly, without any prior preparation.

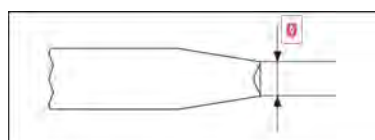

MSA	Numbers	Ø	Length x Ø	Kg
32.003-00	0	0.25 mm	60 x 2.60 mm	0.002
32.003-01	1	0.30 mm	60 x 2.60 mm	0.002
32.003-02	2	0.35 mm	60 x 2.60 mm	0.002
32.003-03	3	0.40 mm	60 x 2.60 mm	0.002
32.003-04	4	0.45 mm	60 x 2.60 mm	0.002
32.003-05	5	0.50 mm	60 x 2.60 mm	0.002
32.003-06	6	0.55 mm	60 x 2.60 mm	0.002
32.003-07	7	0.60 mm	60 x 2.60 mm	0.002
32.003-08	8	0.65 mm	60 x 2.60 mm	0.002
32.003-09	9	0.70 mm	60 x 2.60 mm	0.002
32.003-10	10	0.75 mm	60 x 2.60 mm	0.002
32.003-11	11	0.80 mm	60 x 2.60 mm	0.002
32.003-12	12	0.85 mm	60 x 2.60 mm	0.002
32.003-13	13	0.90 mm	60 x 2.60 mm	0.002
32.003-14	14	0.95 mm	60 x 2.60 mm	0.002
32.003-15	15	1.00 mm	60 x 2.60 mm	0.002
32.003-16	16	1.05 mm	60 x 2.60 mm	0.002
32.003-17	17	1.10 mm	60 x 2.60 mm	0.002
32.003-18	18	1.15 mm	60 x 2.60 mm	0.002
32.003-19	19	1.20 mm	60 x 2.60 mm	0.002
32.003-20	20	1.25 mm	60 x 2.60 mm	0.002
32.003-21	21	1.30 mm	60 x 2.60 mm	0.002
32.003-22	22	1.35 mm	60 x 2.60 mm	0.002

GLARDON® VALLORBE "Swiss Made" beading tool.



MSA	Length	Ø ring	Ø handle	Kg
18.130-S	50 mm	10 mm	36 mm	0.014

Wooden handle for beading tools with 1 brass die Ø 2.60 mm to quickly fit the beading tool.

Tools for polishing the inside of beading tool heads.



MSA	Base size	Kg
32.020	Ø 30 x 6.90 mm	0.042

Round brass plate for re-burnishing beading tools, with 12 sunken tempered steel heads numbered from 1 to 12.



MSA	Base size	Kg
32.021	Ø 30 x 6.90 mm	0.040

Round brass plate for re-burnishing beading tools, with 12 raised tempered steel heads numbered from 1 to 12.



MSA	Base size	Kg
32.030	60 x 28 x 15 mm	0.192

Rectangular steel plate for re-burnishing beading tools, with 40 sunken tempered steel balls numbered from 0.60 to 1.75.

The millgrain head is equipped with a small toothed wheel used for jewellery decoration.



MSA	Packaging size	Kg
32.100	110 x 80 x 50 mm	0.175

Assortment of 6 millgrains.

Contents :
 - 1 wooden base
 - 1 vice with wooden handle and 1 tightening chuck
 - Numbers : 4 - 6 - 8 - 10 - 12 - 14.

ASSORTMENT



MSA	Numbers	Wheel thickness	Length x Ø	Kg
32.101-01	1	0.35 mm	67.5 x 2.5 mm	0.002
32.101-02	2	0.36 mm	67.5 x 2.5 mm	0.002
32.101-03	3	0.41 mm	67.5 x 2.5 mm	0.002
32.101-04	4	0.42 mm	67.5 x 2.5 mm	0.002
32.101-05	5	0.43 mm	67.5 x 2.5 mm	0.002
32.101-06	6	0.45 mm	67.5 x 2.5 mm	0.002
32.101-07	7	0.47 mm	67.5 x 2.5 mm	0.002
32.101-08	8	0.48 mm	67.5 x 2.5 mm	0.002
32.101-09	9	0.49 mm	67.5 x 2.5 mm	0.002
32.101-10	10	0.50 mm	67.5 x 2.5 mm	0.002
32.101-11	11	0.52 mm	67.5 x 2.5 mm	0.002
32.101-12	12	0.57 mm	67.5 x 2.5 mm	0.002
32.101-13	13	0.61 mm	67.5 x 2.5 mm	0.002
32.101-14	14	0.62 mm	67.5 x 2.5 mm	0.002
32.101-15	15	0.63 mm	67.5 x 2.5 mm	0.002

Millgrain.

38



REAGENTS FOR TESTING PRECIOUS METALS

38 - 2

DIAMOND TESTERS

38 - 4

WRAPPING PAPER FOR DIAMONDS AND PRECIOUS STONES

38 - 5

REAGENTS FOR TESTING PRECIOUS METALS



Note for items with this pictogram :

- Caustic product not destined for home use.
- Toxicity class 2.
- It contains more than 10 % of mineral acid.
- Avoid contact with skin and eyes.



MSA	Packaging size	Kg
38.000	140 x 100 x 160 mm	0.790

Assortment of reagents, delivered in a wooden box including :

- 1 phial of reagent for gold 10-14 carats
- 1 phial of reagent for gold 18 carats
- 1 phial of reagent for platinum
- 1 phial of reagent for gold 8-12 carats
- 1 phial of reagent for silver
- 1 synthetic touchstone
- 5 empty glass bottles of 15 cc.



ASSORTMENT



MSA	Length x Ø	Kg
38.005	130 x 30 mm	0.047

Phial of reagent for gold 20-24 carats.



MSA	Length x Ø	Kg
38.003	130 x 30 mm	0.048

Phial of reagent for gold 18 carats.



MSA	Length x Ø	Kg
38.002	130 x 30 mm	0.051

Phial of reagent for gold 10-14 carats.



MSA	Length x Ø	Kg
38.006	130 x 30 mm	0.048

Phial of reagent for platinum.



MSA	Length x Ø	Kg
38.004	130 x 30 mm	0.046

Phial of reagent for silver.



MSA	Size	Kg
38.016-N	60 x 100 x 8 mm	0.150

Natural touchstone.



MSA	Volume	Kg
38.013	15 cc	0.023

Glass bottle for reagent.



MSA	Volume	Kg
38.014	30 cc	0.050

Glass bottle for reagent.

DIAMOND TESTERS

New range of diamond testers.

- Ergonomically shaped for a comfortable held
- Intuitive finger grip pads for increased user-friendliness and ease of use
- Precision retractable probe-tip with enhanced durability
- Very fast warm-up time
- Auto-off function to preserve battery life.

GEMORO



MSA	Size	Kg
38.127	170 x 25 x 50 mm	0.350

ULTRATESTER 3+® diamond tester.

Identifies, detects and separates diamond from zircon and moissanite. Glowing light bar / probe tip cone for quick stone identification.

- GREEN = diamond
- BLUE = moissanite
- PINK = sapphire
- RED = metal

Delivered with 3 rechargeable NiMH AAA batteries, AC adapter, loose stone holder and compact rubberized portable storage case.

GEMORO



MSA	Size	Kg
38.129	170 x 25 x 50 mm	0.350

PRO-D 3® diamond tester.

Identifies, detects and separates diamond or sapphire from zircon. Glowing light bar / probe tip cone for quick stone identification.

- GREEN = diamond
- PINK = sapphire
- RED = metal

Delivered with 3 rechargeable NiMH AAA batteries, AC adapter, loose stone holder and compact rubberized portable storage case.

Diamond Selector II.



MSA	Size	Kg
38.125	160 x 40 x 20 mm	0.174

DIAMOND SELECTOR II diamond tester.

- Measures heat conductivity for separating diamond particles
- Detects the presence of the following particles : cubic zirconia, synthetic white spinel, rutile, strontium titanate, zircon, white sapphire, G.G.G. and Y.A.G.
- Totally portable and independent, it works with one 9V battery (not included).

Delivered in a leather imitation pouch with English user's manual.



MSA	Size	Kg
38.110	80 x 45 mm	0.088

Pack of 25 wrapping paper sheets for diamonds and precious stones. Inside furnished with 2 light blue sheets.



MSA	Size	Kg
38.111	80 x 45 mm	0.073

Pack of 25 wrapping paper sheets for diamonds and precious stones. Inside furnished with 1 white and 1 light blue sheet.



MSA	Size	Kg
38.112	80 x 45 mm	0.085

Pack of 25 wrapping paper sheets for diamonds and precious stones. Inside furnished with 2 white sheets.

42



KERN® BALANCES

42 - 2

POCKET SCALES AND ACCESSORIES

42 - 11





Internal adjusting program : quick setting of the balance's accuracy with internal adjusting weight (motor-driven).



External adjusting program : for quick setting of the balance's accuracy. External adjusting weight required.



Data interface RS-232 : to connect the balance to a printer, PC or network.



GLP/ISO log : the balance displays the weight, date and time, regardless of printer connected.



GLP/ISO log : with weight, date and time. Only with KERN printers.



Piece counting : reference quantities selectable. Display can be switched from piece to weight.

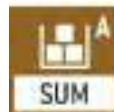

Summation level : weight values of similar goods can be aggregated and the sum printed.



Formula : separate memory for the weight of the tare container and the recipe ingredients (net total).



Percentage determination : displays the deviation from the reference weight (100%) in % instead of grams.



Weighing units : can be switched to e.g. nonmetric units at the touch of a key.



Weighing with tolerance range : upper and lower limiting can be programmed individually, e. g. sorting and portioning.



Vibration-free weighing : (animal weighing program) Vibrations are filtered out so that a stable weight is obtained.



Suspended weighing : load support with hook on the underside of the balance.



Battery operation : prepared to function on battery. The battery type is specified for each device.



Rechargeable battery pack : rechargeable set.



Universal network adapter : external, with universal input and optional input adapters.
A) UE, GB ; B) UE, GB, CH, USA
C) UE, GB, CH, USA, AUS



Mains adapter : integrated with the balance, 230 V/50 Hz. On request, also as standard for other countries.



Strain gauge : electrical resistor on an elastic deforming body.



Tuning fork principle : a resonating body (like a tuning fork) is electromagnetically excited, causing it to oscillate.



Electromagnetic force compensation : coil in a permanent magnet. For the most accurate weightings.



Single cell technology : advanced version of the force compensation principle with the highest level of precision.



Verification possible : the time required for verification is specified in the pictogram.



DAKkS calibration : the time required for DAKkS calibration is shown in the pictogram.



Warranty : the warranty period is shown in the pictogram (2 years).

Note : According to EU directive 2014/31/EU, balances must be officially verified if they are used as follows :

- in commercial transactions if the price of goods is determined by weighing
- in the production of medicines in pharmacies as well as for analyses in the medical and pharmaceutical laboratory
- for official purposes
- in the production of finished packages
- in medicine.

KERN® balances and scales are worldwide renowned for being precise and reliable.
Tare function, parts counting, memory, percentage determination and internal or external adjusting are possible.
All balances and scales are delivered with user's manual. Numerous of other models are available according to your needs.
Please contact our sales department.



42 g / 120 g (0.01 mg / 0.1 mg)



MSA	Model	Voltage	Size	Kg
42.189	ABT 120-5DNM	220 - 240 V 50 Hz	215 x 340 x 335 mm	12.600

Dual-range analytical balance, Premium model with Single-Cell weighing system
 - Automatic internal adjustment in the case of a change in temperature > 0.5° C and time-controlled every 4 hours, guarantees high degree of accuracy and makes the balance independent of its location of use
 - Dosage aid controlled through the display
 - Large glass draught shield with 3 sliding doors for easy access to the items being weighed
 - Stainless steel weighing plate Ø 80 mm.

Weighing capacity max.	42 g / 120 g
Readability	0.01 mg / 0.1 mg
Repeatability	0.02 mg / 0.1 mg
Linearity	0.05 mg / 0.2 mg
Recommended adjusting weight	-
Other weighing units	ct
Screen, digits height	14 mm
Minimum piece weight (counting)	10 mg
Adapters included	CH EURO UK US
Option Verification	965-201
Option DAkkS Certificate	963-101



160 g (0.1 mg)



MSA	Model	Voltage	Size	Kg
42.184	ALJ 160-4AM	110 - 240 V	210 x 340 x 330 mm	9.200

Analytical balance with large weighing ranges.
 - Automatic internal adjustment in the case of a change in temperature greater than or equal to 1.2° C and time-controlled at defined intervals, guarantees high degree of accuracy and makes the balance independent of its location of use
 - Ergonomically optimised keypad for left and righthanded users
 - Large glass draught shield with 3 sliding doors for easy access to the items being weighed
 - Compact size, practical for small spaces
 - Stainless steel weighing plate Ø 80 mm.

Weighing capacity max.	160 g
Readability	0.1 mg
Repeatability	0.1 mg
Linearity	0.3 mg
Recommended adjusting weight	150 g (E2)
Other weighing units	ct - dwt - gn - lb - mo - oz - ozt - tl (HK) - tl (SG, MY) - tl (TW)
Screen, digits height	17 mm
Minimum piece weight (counting)	10 mg
Adapters included	CH EURO UK US
Option Verification	965-201
Option DAkkS Certificate	963-101

KERN



210 g (0.1 mg)



OPTION

MSA	Model	Voltage	Size	Kg
42.187	ADB 200-4	100 - 265 V 50/60 Hz	207 x 310 x 315 mm	6.900

The price leader in analytical balances.

- Adjusting program CAL for quick setting of the balance accuracy using an external test weight
- Large glass draught shield with 3 sliding doors for easy access to the items being weighed
- Compact size, practical for small spaces
- Simple and convenient 6-key operation
- Stainless steel weighing plate Ø 90 mm.

Weighing capacity max.	210 g
Readability	0.1 mg
Repeatability	0.2 mg
Linearity	0.4 mg
Recommended adjusting weight	200 g (E2)
Other weighing units	ct - lb - oz

Screen, digits height	16 mm
Minimum piece weight (counting)	10 mg

Adapters included CH EURO UK US

Option Verification	-
Option DAkkS Certificate	963-101

KERN



320 g (0.1 mg)



OPTION



FACTORY

MSA	Model	Voltage	Size	Kg
42.188	ABJ 320-4NM	110 - 230 V	210 x 340 x 325 mm	8.970

The bestseller in analytical balances, with high-quality Single-Cell weighing system.

- Automatic internal adjustment in the case of a change in temperature > 2° C and time-controlled every 4 hours, guarantees high degree of accuracy and makes the balance independent of its location of use
- Dosage aid controlled through the display
- Stainless steel weighing plate Ø 91 mm.

Weighing capacity max.	320 g
Readability	0.1 mg
Repeatability	0.2 mg
Linearity	0.3 mg
Other weighing units	ct

Screen, digits height	14 mm
Minimum piece weight (counting)	10 mg

Adapters included CH EURO UK US

Option Verification	965-201
Option DAkkS Certificate	963-101

KERN



200 g (1 mg)



OPTION

MSA	Model	Voltage	Size	Kg
42.174	PFB 200-3	100 - 240 V 50/60 Hz	210 x 315 x 90 mm	2.340

Quick-display precision balance with user-friendly concept of operation.

- Easy to use: all primary functions have their own key on the keypad
- Compact size, practical for small spaces
- Capacity display : a bar lights up to show how much of the weighing range is still available
- Standard draught shield
- Stainless steel weighing plate Ø 80 mm.

Weighing capacity max.	200 g
Readability	1 mg
Repeatability	2 mg
Linearity	5 mg
Recommended adjusting weight	200 g (F1)
Other weighing units	bat - ct - dot - dwt - lb - mo - N - oz - ozt - tl (CN) - tl (HK) - tl (TW)
Screen, digits height	15 mm
Minimum piece weight (counting)	20 mg
Adapters included	CH EURO UK US
Option Verification	-
Option DAkkS Certificate	963-127

KERN



300 g (1 mg)

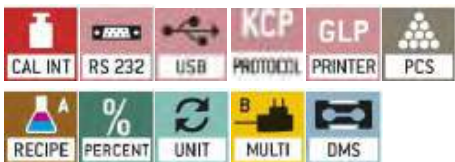

OPTION

MSA	Model	Voltage	Size	Kg
42.340	EWJ 300-3	100 - 240 V 50/60 Hz	220 x 315 x 90 mm	3.800

High-quality precision balance with automatic internal adjustment.

- Easy to use : all primary functions have their own key on the keypad
- Automatic internal adjustment time-controlled every 2 hours. Guarantees high degree of accuracy and makes the balance independent of its location
- Capacity display : a bar lights up to show how much of the weighing range is still available
- Standard draught shield
- Stainless steel weighing plate Ø 80 mm.

Weighing capacity max.	300 g
Readability	1 mg
Repeatability	2 mg
Linearity	5 mg
Recommended adjusting weight	300 g (F1)
Other weighing units	ct - dwt - lb - mo - oz - ozt - tl (HK) - tl (SG, MY) - tl (TW)
Screen, digits height	16.5 mm
Minimum piece weight (counting)	20 mg
Adapters included	CH EURO UK US
Option Verification	-
Option DAkkS Certificate	963-127

KERN



620 g (1 mg)



MSA	Model	Voltage	Size	Kg
42.341	PNJ 600-3M	220 - 240 V 50 Hz	196 x 293 x 266 mm	5.570

- Precision balance with robust tuning fork measuring system.
- Automatic internal adjustment, guarantees high degree of accuracy and makes the balance independent of its location of use
 - Capacity display : a bar lights up to show how much of the weighing range is still available
 - Precise counting : the automatic reference weight optimisation of reference weight gradually improves the average piece weight value
 - Compact size, practical for small spaces
 - Large glass draught shield with 3 sliding doors for easy access to the items being weighed
 - Dimensions plateau en acier inoxydable Ø 140 mm.

Weighing capacity max.	620 g
Readability	1 mg
Repeatability	1 mg
Linearity	4 mg
Other weighing units	ct - dwt - lb - mo - oz - ozt - tl (HK) - tl (SG, MY) - tl (TW) - tol
Screen, digits height	16.5 mm
Minimum piece weight (counting)	10 mg
Adapters included	CH EURO UK US
Option Verification	965-216
Option DAKkS Certificate	963-127

KERN



620 g (1mg)



MSA	Model	Voltage	Size	Kg
42.332	EW 620-3NM	220 - 240 V 50 Hz	182 x 235 x 75 mm	2.960

- Precision balance with robust tuning fork measuring system.
- Adjusting program CAL for quick setting of the balance accuracy using an external test weight
 - Stable temperature behaviour
 - Short stabilisation time
 - Shock proof construction
 - High corner load performance
 - GLP/ISO record keeping of weight values
 - Totalising of pieces when counting
 - Draught shield standard
 - Stainless steel weighing plate Ø 118 mm.

Weighing capacity max.	620 g
Readability	1 mg
Repeatability	1 mg
Linearity	3 mg
Recommended adjusting weight	500 g (E2)
Other weighing units	ct dwt lb mo oz ozt tl (HK) tl (SG, MY) tl (TW) tol
Screen, digits height	17 mm
Minimum piece weight (counting)	10 mg
Adapters included	CH EURO
Option Verification	-
Option DAKkS Certificate	963-127

KERN



500 g (10 mg)



OPTION

MSA	Model	Size	Kg
42.343	EHA 500-2	210 x 165 x 65 mm	0.720

Compact all-round balance with robust stainless steel weighing plate for use in industry and teaching.

- Large, shock proof weighing plate made from stainless steel, hygienic and easy to clean
- Ergonomically optimised keypad
- Simple and convenient 5-key operation
- Adjusting external program CAL for quick setting of the balance accuracy
- Stainless steel weighing plate Ø 105 mm.

Weighing capacity max.	500 g
Readability	10 mg
Repeatability	30 mg
Linearity	30 mg
Recommended adjusting weight	500 g (F2)
Other weighing units	ct - dwt - gn - oz
Screen, digits height	22 mm
Minimum piece weight (counting)	100 mg
Adapters included	CH EURO UK
Option Verification	-
Option DAkkS Certificate	963-127

KERN



600 g (10 mg)



OPTION



FACTORY

MSA	Model	Voltage	Size	Kg
42.342	EWJ 600-2M	110 - 240 V 50/60 Hz	220 x 315 x 90 mm	3.500

High-quality precision balance with automatic internal adjustment.

- Easy to use : all primary functions have their own key on the keypad
- Automatic internal adjustment time-controlled every 2 hours. Guarantees high degree of accuracy and makes the balance independent of its location
- Capacity display : a bar lights up to show how much of the weighing range is still available
- Standard draught shield
- Stainless steel weighing plate Ø 120 mm.

Weighing capacity max.	600 g
Readability	10 mg
Repeatability	10 mg
Linearity	30 mg
Recommended adjusting weight	600 g (F1)
Other weighing units	-
Screen, digits height	16.5 mm
Minimum piece weight (counting)	200 mg
Adapters included	CH EURO UK US
Option Verification	965-216
Option DAkkS Certificate	963-127

KERN



1000 g (10 mg)

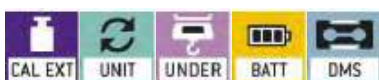

OPTION

MSA	Model	Power	Size	Kg
42.141	EMB 1000-2	1 battery 9 V	170 x 244 x 52 mm	1.300

Entry-level laboratory balance with tremendous weighing performance.

- Simple and convenient 2-key operation
- Tare function facilitates formulation work
- Particularly flat design
- Ready for use : batteries included
- Size of the removable plastic weighing plate Ø 150 mm.

Delivered with 1 hook for weighing of suspended loads.

Weighing capacity max.	1000 g
Readability	10 mg
Repeatability	10 mg
Linearity	50 mg
Recommended adjusting weight	1 Kg (E1)
Other weighing units	dwt - oz - ozt
Screen, digits height	15 mm
Option Verification	-
Option DAkkS Certificate	963-127

KERN



1200 g (10 mg)



OPTION

MSA	Model	Voltage	Size	Kg
42.137	PFB 1200-2	100 - 240 V 50/60 Hz	210 x 315 x 90 mm	2.370

Quick-displaying precision balance with user-friendly operation modes.

- Easy to use : all primary functions have their own key on the keypad
- Compact size, practical for small spaces
- Capacity display : a bar lights up to show how much of the weighing range is still available
- Level indicator and levelling feet for precise levelling of the scale, fitted as standard, to give the most accurate weighing results
- Standard draught shield, weighing space 158 x 143 x 64 mm
- Stainless steel weighing plate Ø 120 mm.

Weighing capacity max.	1200 g
Readability	10 mg
Repeatability	10 mg
Linearity	30 mg
Recommended adjusting weight	1 Kg (F1)
Other weighing units	bat - ct - dot - dwt - lb - mo - N - oz - ozt - tl (CN) - tl (HK) - tl (TW)
Screen, digits height	15 mm
Minimum piece weight (counting)	200 mg
Adapters included	CH EURO UK US
Option Verification	-
Option DAkkS Certificate	963-127

KERN



1000 g (100 mg)



OPTION

MSA	Model	Voltage	Size	Kg
42.344	EHA 1000-1	110 - 240 V	225 x 160 x 50 mm	0.750

Compact all-round balance with robust stainless steel weighing plate for use in industry and teaching.

- Large, shock proof weighing plate made from stainless steel, hygienic and easy to clean
- Ergonomically optimised keypad
- Simple and convenient 5-key operation
- Adjusting external program CAL for quick setting of the balance accuracy
- Stainless steel weighing plate Ø 105 mm.

Weighing capacity max.	1000 g
Readability	100 mg
Repeatability	300 mg
Linearity	300 mg
Recommended adjusting weight	1 Kg (M1)
Other weighing units	ct - dwt - gn - oz
Screen, digits height	22 mm
Minimum piece weight (counting)	1 g
Adapters included	CH EURO UK
Option Verification	-
Option DAkkS Certificate	963-127

KERN



2500 g (10 mg)



OPTION

MSA	Model	Voltage	Size	Kg
42.185	PCB 2500-2	100 - 240 V 50/60 Hz	166 x 250 x 80 mm	1.800

Compact laboratory balance.

- PRE-TARE function for manual subtraction of a known container weight, useful for checking fill-levels
- Freely programmable weighing unit, e.g. display direct in special units such as length of thread g/m, paperweight g/m², etc.
- With the recipe function you can weigh the different ingredients of a mixture. As a check, you can also call up the total weight of all the ingredients
- Plus/minus weighing procedures
- Stainless steel weighing plate, size 130 x 130 mm.

Weighing capacity max.	2500 g
Readability	10 mg
Repeatability	10 mg
Linearity	50 mg
Recommended adjusting weight	2 Kg (F1)
Other weighing units	ct - dwt - ffa - lb - mo - oz - ozt - tl (HK) - tl (SG, MY) - tl (TW) - to
Screen, digits height	21 mm
Minimum piece weight (counting)	200 mg
Adapters included	CH EURO UK US
Option Verification	-
Option DAkkS Certificate	963-127

KERN



6 Kg (1 g)



OPTION

MSA	Model	Voltage	Size	Kg
42.160	440-53N	100 - 240 V 50/60 Hz	165 x 230 x 80 mm	1.600

Compact laboratory scale.

- Compact size, practical for small spaces
- Percentage determination: makes it possible to store a given weight value (100%) and to determine deviations from this target value.
- Stainless steel weighing plate, size 150 x 170 mm.

Weighing capacity max.	6 Kg
Readability	1 g
Repeatability	1 g
Linearity	2 g
Recommended adjusting weight	5 Kg (M2)
Other weighing units	dwt - lb - mo - oz - ozt - tl (HK) - tl (TW) - tol
Screen, digits height	15 mm
Minimum piece weight (counting)	20 g
Adapters included	CH EURO UK US
Option Verification	-
Option DAkkS Certificate	963-128

KERN



12 Kg (100 mg)



OPTION



MSA	Model	Voltage	Size	Kg
42.186	GAB 12K0.1N	110 - 230 V	320 x 330 x 125 mm	4.200

Check-weighing and portioning balance.

- Compact size, practical for small spaces
- High mobility : thanks to battery operation (optional)
- Weighing with tolerance range (Check-weighing) : input of an upper/lower limit value. A visual signal assists with portioning, dispensing or grading
- Totalising of pieces when counting
- Stainless steel weighing plate, size 294 x 225 mm.

Weighing capacity max.	12 Kg
Readability	100 mg
Repeatability	100 mg
Linearity	300 mg
Recommended adjusting weight	12 Kg (F2)
Other weighing units	-
Screen, digits height	24 mm
Minimum piece weight (counting)	1 g
Adapters included	CH EURO UK
Option Verification	-
Option DAkkS Certificate	963-128

TANITA® and TANGENT® digital pocket scales easy to use with LCD screen for clear reading. Tare function, high precision, calibration possible and display for low battery. All the scales are delivered with batteries, user's manual and synthetic pouch.



MSA	Model	Colour	Size	Kg
42.102	(1) Tangent KP-104	Black	60 x 135 x 16 mm	0.140
42.103	(2) Tangent KP-104	Silver	60 x 135 x 16 mm	0.140

TANGENT® pocket scale.

Weighing unit	Capacity	Graduation
Gram (g)	(1) 200	0.1
	(2) 300	0.1
Ounce (oz)	(1) 7.055	0.005
	(2) 10.58	0.005
Troy Ounce (ozt)	(1) 6.43	0.005
	(2) 9.645	0.005
Penny weight (dwt)	(1) 126.6	0.1
	(2) 192.9	0.1



MSA	Model	Colour	Size	Kg
42.110	1479V	Black	155 x 75 x 15 mm	0.203

TANITA® pocket scale.

Weighing unit	Capacity	Graduation
Gram (g)	120	0.1

KERN



MSA	Size	Kg
42.316	123 x 72 x 15 mm	0.016

Precious stones plate in aluminium with practical spout.

98



BASIC TOOLS KITS





MSA	Size	Kg
98.020	265 x 220 x 80 mm	1.025

Basic tools kit in a plastic suitcase.

Composition :

MSA01.020-100	Screwdriver black handle and black head, Ø 1.00 mm
MSA01.020-120	Screwdriver red handle and black head, Ø 1.20 mm
MSA01.020-160	Screwdriver purple handle and black head, Ø 1.60 mm
MSA01.215-100	Screwdriver blade Ø 1.00 mm
MSA01.215-120	Screwdriver blade Ø 1.20 mm
MSA01.215-160	Screwdriver blade Ø 1.60 mm
MSA12.301-AA	Tweezers AA stainless steel
PERF364	Plastic tweezer for batteries
MSA04.012	Hammer with cylindrical brass head
MSA07.013	Case opener for cases with screwed-on backs
MSA07.006-01	Case opener for cases with snapped-on backs
MSA10.501	Universal black plastic bracelet holder
MSA09.303	Casing cushion, Ø 55 x height 12 mm
MSA00.025-2.5	Horotec eyeglass in black plastic, no. 2.5 = 5x
MSA10.300	Tool for fitting/removing spring bars
MSA10.302-A	Reversible tip, Ø 0.80 mm x fork width 1.20 mm
MSA10.503-C	Assortment of pin punches
MSA10.527	Handle for pin punch tool
MSA11.809	Flat nose pliers, serrated anti-skid interior
MSA26.136	Microfiber polishing cloth, grey 35 x 30 cm
MSA24.215-25X16	Soft black bench mat, 25 x 16 cm

Upon request, we are able to study and produce customized tooling kits. For further information, please contact our sales department.

Here bellow are some examples :



98



PROFESSIONAL KITS FOR AFTER-SALES SERVICE

98 - 2





MSA	Size	Kg
98.015	370 x 285 x 105 mm	1.232

Basic tools kit for battery and bracelet change.
Delivered in a sturdy aluminium suitcase (with keys).

Kit contents :

MSA00.007	<i>Stainless steel wire eyeglass holder, large model</i>
MSA01.101-060	<i>Chromed brass screwdriver, Ø 0.60 mm pink</i>
MSA01.101-080	<i>Chromed brass screwdriver, Ø 0.80 mm yellow</i>
MSA01.101-100	<i>Chromed brass screwdriver, Ø 1.00 mm black</i>
MSA01.101-120	<i>Chromed brass screwdriver, Ø 1.20 mm red</i>
MSA01.102-060	<i>Screwdriver blade, Ø 0.60 mm</i>
MSA01.102-080	<i>Screwdriver blade, Ø 0.80 mm</i>
MSA01.102-100	<i>Screwdriver blade, Ø 1.00 mm</i>
MSA01.102-120	<i>Screwdriver blade, Ø 1.20 mm</i>
MSA01.400-1.5	<i>Phillips screwdriver, Ø 1.50 mm violet</i>
MSA01.400-2.0	<i>Phillips screwdriver, Ø 2.00 mm green</i>
MSA01.400-2.5	<i>Phillips screwdriver, Ø 2.50 mm blue</i>
MSA01.400-3.0	<i>Phillips screwdriver, Ø 3.00 mm brown</i>
MSA07.006-01	<i>Knife case-opener with 2 retractable blades</i>
MSA07.110	<i>HOROTEC® press for closing snap-on case backs</i>
MSA10.531	<i>Tool for removing bracelet pins</i>
MSA11.809	<i>Flat nose pliers, serrated anti-skid interior</i>
MSA12.812-1	<i>100% antimagnetic steel HOROSWISS® tweezers, no. 1</i>
MSA19.000	<i>Universal battery tester</i>
MSA26.136	<i>Microfiber cleaning grey cloth, 35 x 30 cm</i>
MSA28.104	<i>Silicon grease SEIKO® TSF-451, with applicator</i>
PERF111-2.5	<i>Plastic eyeglass with screwed aluminium ring, no. 2.5</i>
PERF364	<i>Plastic battery tweezers</i>
PERF380	<i>Case-opener with 2 jaws, for watches with screw-on case backs</i>
PERF458	<i>Black plastic tool for removing spring bars</i>

Upon request, we are able to study and produce customized tooling kits. For further information, please contact our sales department.

Here below are some examples :





EYEGASSES	PE - 2
SCREWDRIVERS	PE - 3
PIN VICES / HAMMERS	PE - 4
SAW FRAMES / DRAW PLATES	PE - 5
HAND TOOLS / SPRING BAR TOOLS	PE - 6
CRYSTAL PRESSES	PE - 7
CASE TOOLS / CASE HOLDERS	PE - 8
VICES / MOVEMENT HOLDERS	PE - 10
PLIERS	PE - 11
TWEEZERS	PE - 12
PACKAGING / CLEANING	PE - 13
RING STICKS AND RING GAUGES	PE - 14
OTHER ARTICLES	PE - 15



EYEGASSES



PERF	Magnification	Ø lens	Kg
111-1	10.0x	21 mm	0.012
111-1.5	6.5x	21 mm	0.012
111-2	5.0x	21 mm	0.012
111-2.5	4.0x	21 mm	0.012
111-3	3.5x	21 mm	0.012
111-3.5	3.0x	21 mm	0.012
111-4	2.5x	21 mm	0.012

Plastic eyeglass with screwed aluminium ring.



PERF	Magnification	Ø lens	Kg
121-1	10.0x	20 mm	0.013
121-1.5	6.5x	20 mm	0.013
121-2	5.0x	20 mm	0.013
121-2.5	4.0x	20 mm	0.013
121-3	3.5x	20 mm	0.013
121-3.5	3.0x	20 mm	0.013
121-4	2.5x	20 mm	0.013

Simple plastic eyeglass.



PERF	Magnification	Ø lens	Kg
115-1	10.0x	23 mm	0.015
115-1.5	6.5x	23 mm	0.015
115-2	5.0x	23 mm	0.015
115-2.5	4.0x	23 mm	0.015
115-3	3.5x	23 mm	0.015
115-3.5	3.0x	23 mm	0.015
115-4	2.5x	23 mm	0.015

Simple plastic eyeglass with riveted head band.



PERF	Magnification	Ø lens	Kg
131-1	10.0x	23 mm	0.016
131-1.5	6.5x	23 mm	0.016
131-2	5.0x	23 mm	0.016
131-2.5	4.0x	23 mm	0.016
131-3	3.5x	23 mm	0.016
131-3.5	3.0x	23 mm	0.016
131-4	2.5x	23 mm	0.016

Plastic eyeglass with clamp for all types of glasses.



PERF	Magnification	Ø lenses	Kg
132	10x	16 mm	0.050

Chromed triplet magnifier.



PERF	Magnification	Ø lens	Kg
116-1	10.0x	24 mm	0.013
116-1.5	6.5x	24 mm	0.013
116-2	5.0x	24 mm	0.013
116-2.5	4.0x	24 mm	0.013
116-3	3.5x	24 mm	0.013
116-3.5	3.0x	24 mm	0.013
116-4	2.5x	24 mm	0.013

Simple aluminium eyeglass.



PERF	Magnification	Ø lenses	Kg
133	10x	16 mm	0.047

Chromed triplet hexagonal magnifier.



ASSORTMENT

PERF	Ø blades	Kg
020	0.50...2.50 mm	0.200

Assortment of 9 screwdrivers on stand.



ASSORTMENT

PERF	Ø blades	Packaging size	Kg
328	0.60...3.00 mm	155 x 122 x 30 mm	0.310

Assortment of 9 screwdrivers.
Delivered in a wooden case.



ASSORTMENT

PERF	Ø blades	Kg
034	0.60...2.50 mm	0.250

Assortment of 8 screwdrivers on turning stand.
Composed of 7 flat screwdrivers and 1 Phillips screwdriver Ø 2.50 mm.



ASSORTMENT

PERF	Ø blades	Packaging size	Kg
329	1.00...2.00 mm	115 x 72 x 28 mm	0.140

Assortment of 6 screwdrivers.
Delivered in a wooden case.



ASSORTMENT

PERF	Ø blades	Kg
595	0.60...3.00 mm	0.450

Assortment of 9 screwdrivers on turning stand.



PERF	Size	Kg
332	55 x Ø 16 mm	0.031

Sharpener tool for screwdriver blades, to be used with 1 sharpening flat stone.
Screwdriver not included.



ASSORTMENT

PERF	Ø blades	Packaging size	Kg
322	0.80...2.00 mm	85 x 100 mm	0.065

Assortment of 7 screwdrivers.
Delivered in a plastic pouch.



PERF	Length	Kg
318	90 mm	0.035

Screwdriver with tightening chuck and 4 blades (2 flat, 1 Phillips and 1 for removing spring bars).

PIN VICES / HAMMERS

Pin vices.



ASSORTMENT

PERF	Size	Kg
045	65 x 110 mm	0.149

Assortment of 4 oxidized black pin vices.
Delivered in a plastic pouch.



PERF	Length	Kg
330	105 mm	0.035

Nickel-plated double pin vice with rounded heads and 2 tightening chucks.



PERF	Length	Kg
015	105 mm	0.023

Quick tightening pin vice.



PERF	Length	Kg
022	95 mm	0.011

Thin brass pin vice with rounded head and 1 tightening chuck.



PERF	Length	Ø tightening	Kg
046	115 mm	0.00...8.00 mm	0.036

Double nickel-plated pin vice with hexagonal heads and 2 tightening chucks.



PERF	Length	Kg
390	85 mm	0.030

Pin vice for crowns from Ø 4 to 5.50 mm.



PERF	Length	Ø tightening	Kg
028	90 mm	0...1 mm	0.025

Brass hand drill with return spring.

Hammers.



PERF	Head length	Total length	Kg
007	54 mm	153 mm	0.040

Watchmaker's hammer with wooden handle, round and flat head on one side and "V" shaped for riveting on the other.



PERF	Head length	Total length	Kg
023	65 mm	240 mm	0.095

Watchmaker's hammer with wooden handle and 2 flat heads, made of brass on one side and Nylon® on the other.

Saw frames.



PERF	Size	Depth	Kg
313	220 x 120 mm	80 mm	0.190

Saw frame with wooden handle, screws and fixing plates to hold the saw blades. Equipped with a wing screw to adjust the tension of the saw blades.



PERF	Size	Depth	Kg
314	200 x 90 mm	70 mm	0.205

Saw frame with wooden handle, screws and fixing plates to hold the saw blades.

Draw plates.



PERF	Size	Kg
031	113 x 26 x 3 mm	0.145

Steel draw plate with 63 holes.



PERF	Size	Kg
032	166 x 35 x 3 mm	0.150

Steel draw plate with 71 holes.



ASSORTMENT

PERF	Size	Ø holes	Kg
035	45 x 17 mm	0.60...1.00 mm	0.140

Assortment of 1 draw plate and 5 taps.

Hand tools.



PERF	Size	Kg
229	105 x 25 mm	0.040

Spring tool for removing hands.

Spring bar tools.



PERF	Length	Kg
458	135 mm	0.025

Black plastic tool for fitting/removing spring bars.

Spare parts :

MSA	Item	Kg
10.304-A	Tip Ø 0.80 mm	0.001
10.304-B	Fork width 3.00 mm	0.001
10.304-C	Fork width 1.20 mm	0.001



PERF	Length	Kg
230	100 mm	0.020

Tool for removing hands.



PERF	Length	Kg
459	145 mm	0.025

Chromed tool for fitting/removing spring bars.

Spare parts :

PERF	Item	Kg
459A	Tip, Ø 0.80 mm / Fork, width 1.20 mm	0.005
459B	Fork, width 4.00 mm	0.005



PERF	Width spatulas	Length	Kg
231	3 mm	110 mm	0.015

Pair of hands levers.



PERF	Size	Kg
176	200 x 73 x 155 mm	2.840

Crystal fitting press with 24 Nylon® dies.

Spare part :

PERF	Item	Kg
176-A	Assortment of 24 dies	0.267



PERF	Size	Kg
169	76 x 40 mm	0.210

Tool for fitting/removing crystals with tension ring.



PERF	Size	Kg
167	185 x 50 x 118 mm	1.170

Crystal fitting press with 12 Nylon® dies.



PERF	Size	Kg
168	180 x 64 x 145 mm	1.840

Crystal fitting press with 28 aluminium dies.

CASE TOOLS / CASE HOLDERS

Case tools.



PERF	Colour	Length	Kg
384-01	Yellow	80 mm	0.030
384-02	Blue	80 mm	0.030
384-03	Red	80 mm	0.030
384-04	Orange	80 mm	0.030

Simple case opener with plastic handle.



PERF	Length	Kg
376	75 mm	0.035

Lever case opener.



PERF	Length	Kg
375	105 mm	0.035

Case-opener with fixed blade and plastic handle.



PERF	Length	Kg
379	115 mm	0.025

Case opener with fixed blade and plastic handle.



PERF	Size	Kg
380	67 x 35 mm	0.080

Case opener with 2 jaws, for watches with screw-on case backs.



← 75 mm →

PERF	Size	Kg
385	90 x 45 x 15 mm	0.120

Case opener with 2 jaws for waterproof cases.



← 55 mm →

PERF	Packaging	Size	Kg
381	Cardboard box	175 x 73 x 12 mm	0.270

Large Jaxa® type case opener.



← 35 mm →

PERF	Packaging	Size	Kg
383	Cardboard box	180 x 83 x 30 mm	0.185

Jaxa® type case opener.



← 35 mm →

PERF	Packaging	Size	Kg
383A	Wooden box	180 x 83 x 30 mm	0.395

Jaxa® type case opener.



ASSORTMENT

PERF	Kg
383J	0.020

Assortment of 12 spare jaws for PERF381, 382, 383 and 383A.

Case holders.



← 50 mm →

PERF	Size	Kg
178	Ø 80 x 46 mm	0.630

Steel case holder with 4 dies.



← 30 mm →

PERF	Size	Kg
170	64 x 46 x 38 mm	0.135

Universal aluminium case holder with 4 Nylon® dies. Can be fixed on a vice.

Spare part :

PERF	Item	Kg
170-A	Nylon® die	0.002



← 60 mm →

PERF	Size	Kg
177	105 x 75 x 45 mm	0.270

Black aluminium case holder with 4 red Nylon® dies. Can be fixed on a vice.

Spare part :

PERF	Item	Kg
177-A	Red Nylon® die	0.006

VICES / MOVEMENT HOLDERS

Vices.



PERF	Width jaws	Kg
460A	51 mm	1.260

Rotating vice with bench clamp.



PERF	Width jaws	Kg
460C	50 mm	1.045

Rotating vice with base to be fixed.



PERF	Length	Kg
331	125 mm	0.085

Vice with black handle.



PERF	Size	Kg
202	160 x 80 x 50 mm	0.175

Jeweller's steel vice with wooden handle.



PERF	Length	Kg
303	149 mm	0.095

Jeweller's wooden vice with wing screw.



PERF	Size	Kg
485	Ø 40 x 150 mm	0.120

Jeweller's wooden vice.

Movement holders.



ASSORTMENT

PERF	Kg
194	0.045

Assortment of 12 plastic movement holders.



PERF	Size	Kg
214	100 x 30 x 17 mm	0.040

Extensible movement holder with springs.



PERF	Length	Kg
250	135 mm	0.110

Pliers for piercing leather straps with return springs. Hole diameter : 1.50 mm.



PERF	Length	Kg
263	120 mm	0.070

Frontal end cutting pliers with return springs.



PERF	Length	Kg
260	125 mm	0.050

Half-round jaws pliers with return springs.



PERF	Length	Kg
264	120 mm	0.060

Side cutting pliers with return springs.



PERF	Length	Kg
261	120 mm	0.065

Flat jaws pliers with return springs.



PERF	Length	Kg
262	120 mm	0.060

Round jaws pliers with return springs.



PERF	Size	Kg
270	142 x 96 x 125 mm	0.210

Wooden pliers support.

TWEEZERS



PERF	Length	Kg
355	163 mm	0.025

Tweezers for stones.



PERF	Length	Kg
357	165 mm	0.023

Tweezers with slide locking for stones.



PERF	Length	Kg
358	165 mm	0.025

Black tweezers for stones.



PERF	Length	Kg
359	180 mm	0.030

Tweezers with shovel for stones.



PERF	Length	Kg
437-00	120 mm	0.015
437-1	120 mm	0.015
437-2	120 mm	0.015
437-3	120 mm	0.015
437-4	120 mm	0.015
437-5	120 mm	0.015
437-MM	120 mm	0.020
437AA-S	120 mm	0.020

Antimagnetic steel tweezers.



PERF	Length	Kg
441-00	130 mm	0.020
441-3	130 mm	0.020
441-AA	130 mm	0.020
441-MM	130 mm	0.020

Brass tweezers.



PERF	Length	Kg
364	125 mm	0.005

Plastic tweezers for batteries.



PERF	Length	Kg
360A	165 mm	0.030

Negative straight soldering tweezers.



PERF	Length	Kg
360B	165 mm	0.030

Negative curved soldering tweezers.



PERF	Length	Kg
366	110 mm	0.025

Tweezers for battery testing.



PERF	Ø eyeglass	Length	Kg
445	23 mm	93 mm	0.020

Tweezers with eyeglass.

Packaging.



PERF	Size	Kg
018	193 x 95 x 21 mm	0.175

Packaging plastic box with sliding transparent lid and 18 divisions.



PERF	Size	Kg
027	80 x 11 mm	0.005

Plastic triangular tray.



PERF	Ø base	Kg
106	100 mm	0.070

Protection kit composed of one dustproof cover and one base with 6 divisions for small parts.



PERF	Size	Kg
317	113 x 66 mm	0.200

Pearls stringing tray.



PERF	Size	Kg
490	198 x 135 x 22 mm	0.253

Packaging box with 24 aluminium round cases.

Cleaning.



PERF	Size	Kg
012	72 x 41 x 29 mm	0.060

White paper for diamonds and precious stones. Delivered in a package of 25 sheets.



PERF	Length	Kg
026	110 mm	0.005

Pencil brush with plastic handle.



PERF	Length	Kg
810	120 mm	0.010

Pen shaped scratch brush.

Spare part :

PERF	Item	Kg
810-A	Refill	0.002



PERF	Length	Kg
266	118 mm	0.085

Rubber dust blower.

RING STICKS AND RING GAUGES



PERF	Length	Kg
162	250 mm	0.200

Aluminium ring stick with 4 graduations.

- French calibration : from 1 to 36.
- Circumference in mm : from 41 to 76.
- American calibration : 1 to 15.
- Diameter in mm : from 13 to 24.2.



PERF	Kg
162A	0.080

Aluminium ring gauge with 4 graduations (36 rings).

- French calibration : from 1 to 36.
- Circumference in mm : from 41 to 76.
- American calibration : 1 to 15.
- Diameter in mm : from 13 to 24.2.



PERF	Size	Kg
161	302 x 144 x 40 mm	0.835

Ring stick and rings with 4 graduations (stick) and 2 graduations (rings).

Delivered in a wooden box.

- French calibration : from 1 to 36 (stick and rings).
- Circumference in mm : from 41 to 76 (stick and rings).
- American calibration : 1 to 15 (stick only).
- Diameter in mm : from 13 to 24.2 (stick only).



PERF	Kg
163A	0.020

Plastic ring gauge with 1 graduation (29 rings).

- American calibration : 1 to 15.



PERF	Size	Kg
021	Ø 28 x 97 mm	0.055

Bottle for acids.



PERF	Size	Kg
080	75 x 54 x 12 mm	0.015

Diamond shovel with handle.



PERF	Size	Kg
024	Ø 65 x 68 mm	0.290

Jar for washing stones with inside basket.



PERF	Size	Kg
095	Ø 16 x 16 mm	0.006
096	Ø 23 x 19 mm	0.017

Cleaning basket for small parts.



ASSORTMENT

PERF	Length	Kg
025	140 mm	0.120

Assortment of 12 files.
Delivered in a plastic pouch.



PERF	Size	Kg
193	70 x 50 x 40 mm	0.210

Oil cup stand with 3 containers and folding lid.



ASSORTMENT

PERF	Ø drills	Packaging size	Kg
030	0.30...1.00 mm	75 x 50 mm	0.005

Assortment of 15 drills.
Delivered in a plastic pouch.



PERF	Size	Kg
195	Ø 53 x 18.5 mm	0.030

Plastic oiler with 1 lid and 3 recesses.

OTHER ARTICLES



PERF	Size	Kg
196	Ø 68 x 29 mm	0.035

Silicon grease with applicator for gaskets.



PERF	Length	Kg
370	130 mm	0.020

Scalpel delivered without blade.

Spare part :

PERF	Item	Kg
370-A	Blade	0.005



PERF	Length	Kg
372	130 mm	0.105

Automatic steel centre-punch.



PERF	Size	Kg
690	185 x 50 x 47 mm	0.110

Spirit lamp with a wick.

Spare part :

PERF	Item	Kg
MSA29.651-A	Wick, length 200 mm	0.009

vallorbe®

SWISS

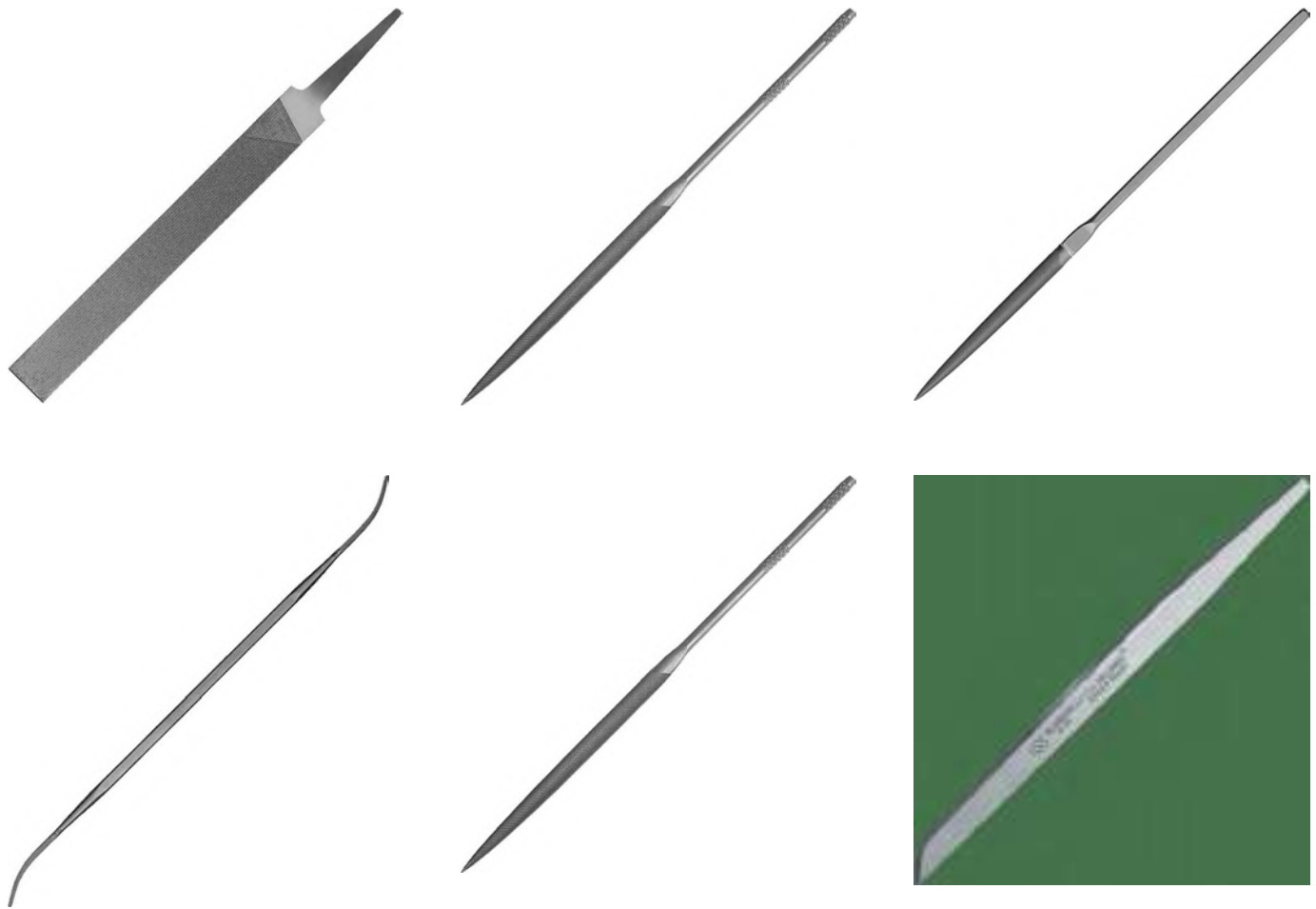

INTRODUCTION	VA - 2
PRECISION FILES - ULP	VA - 3
NEEDLE FILES - ULA	VA - 11
ESCAPEMENT FILES - ULE	VA - 15
BUFF FILES - ULAC / ULEC	VA - 18
DIAMOND FILES - UDA	VA - 21
CERAMIC FIBRE FILES - ULF	VA - 23
GRAVERS / WATCHMAKERS' GRAVERS - ULO	VA - 25
SPECIAL FILES - ULH / ULPV / ULAV / ULR / URA	VA - 28
FRAMES FOR JEWELLER'S SAW BLADES / FILES HANDLES - UASB / UAL / UALF	VA - 42

VALLORBE® Swiss Made files.

FOR THE GOOD USE OF THE CATALOG

MAIN DIMENSIONS

Length = L

The measuring points for length (L) vary from one type of file to another. It is therefore necessary to refer to the diagram.

Width x thickness = A x B

Width and thickness are given by :

- A = as a rule length or diameter
- B = mainly thickness.

For the items ULA, ULE, ULP, ULH, ULR and ULO the dimensions are always measured at the widest uncut section.

For the items URA, ULAC, ULEC, UDA, UDR and UDH the dimensions are measured at the widest cut section and these are average values which depend on the number of the cut.

All the dimensions A and B mentioned in this catalogue are given in mm, they have only an indicative value.

SCALE OF CUTS

To determinate number of teeth [Z/cm]

The number of teeth (Z/cm) is obtained by counting perpendicularly to the cut.

In the following table the figures correspond to the number of teeth per cm, for a given length and type of file.

For example, a file 6" in cut 2, shows 31 Z/cm.

The higher the number of teeth, the finer the file (No. 00 = very coarse / No. 10 = very fine).

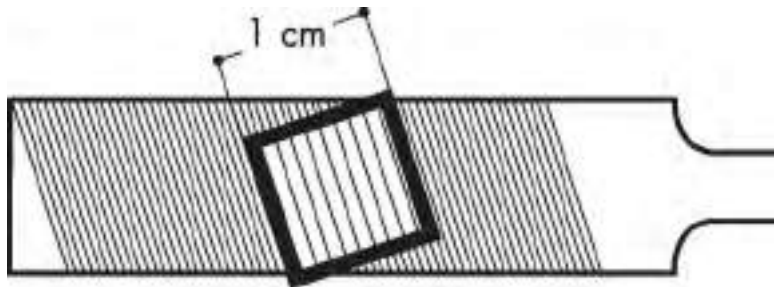

File type	000	00	0	1	2	3	4	5	6	7	8	10
Precision files, lengths 1" to 3.5"	-	20	25	31	38	46	55	68	84	100	116	-
Precision files, lengths 4" to 8"	12	16	20	25	31	38	46	56	68	-	-	-
Precision files, lengths 4" to 8"	9	12	16	20	25	31	38	(46)	(56)	-	-	-
Needle files	-	20	25	31	38	46	56	68	84	-	-	-
Escapement files	-	20	25	31	38	46	56	68	84	100	116	156
Rifflers 150 mm	-	-	25	-	38	-	-	-	-	-	-	-
Rifflers 180-300 mm	-	-	16	-	25	-	-	-	-	-	-	-
HABILIS® files	-	18	21	25	31	-	-	-	-	-	-	-

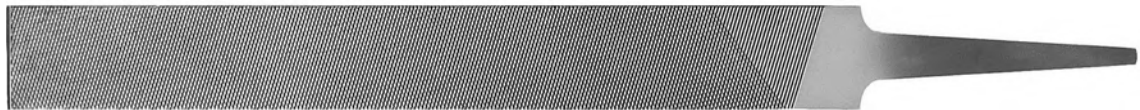
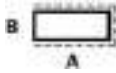

ULP1163 Hand

ULP	000	00	0	1	2	3	4	5	6	L mm	AxB mm
1163-4	-	1163-4-00	1163-4-0	1163-4-1	1163-4-2	1163-4-3	1163-4-4	-	1163-4-6	100	12.5 x 3.0
1163-6	1163-6-000	1163-6-00	1163-6-0	1163-6-1	1163-6-2	1163-6-3	1163-6-4	1163-6-5	1163-6-6	150	18.5 x 4.0
1163-8	1163-8-000	1163-8-00	1163-8-0	1163-8-1	1163-8-2	1163-8-3	1163-8-4	-	-	200	21.3 x 4.8
1163-10	1163-10-000	1163-10-00	1163-10-0	1163-10-1	1163-10-2	1163-10-3	-	-	-	250	25.3 x 6.3
1163-12	1163-12-000	1163-12-00	1163-12-0	1163-12-1	1163-12-2	-	-	-	-	300	29.3 x 7.8



ULP1168 Thin hand

ULP	00	0	1	2	L mm	AxB mm
1168-5	-	1168-5-0	-	-	125	14.5 x 1.7
1168-6	1168-6-00	1168-6-0	1168-6-1	1168-6-2	150	16.5 x 2.0

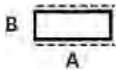

ULP1166 Chequering hand

ULP	00	0	1	2	L mm	AxB mm
1166-6	1166-6-00	1166-6-0	1166-6-1	1166-6-2	150	19.0 x 5.2
1166-8	-	1166-8-0	1166-8-1	1166-8-2	200	22.0 x 5.2

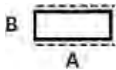

ULP1132 Pillar, 2 sides

ULP	00	0	1	2	3	4	6	L mm	AxB mm
1132-4	1132-4-00	1132-4-0	-	1132-4-2	-	1132-4-4	-	100	9.5 x 2.5
1132-6	1132-6-00	1132-6-0	1132-6-1	1132-6-2	1132-6-3	1132-6-4	1132-6-6	150	12.0 x 4.0
1132-8	1132-8-00	1132-8-0	1132-8-1	1132-8-2	1132-8-3	1132-8-4	-	200	14.5 x 4.5
1132-10	1132-10-00	1132-10-0	1132-10-1	1132-10-2	-	-	-	250	17.5 x 5.3
1132-12	1132-12-00	1132-12-0	-	-	-	-	-	300	19.3 x 6.3

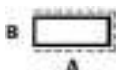

ULP1133 Pillar, 3 sides

ULP	00	0	1	2	3	L mm	AxB mm
1133-4	1133-4-00	-	1133-4-1	1133-4-2	-	100	9.5 x 2.5
1133-6	1133-6-00	1133-6-0	1133-6-1	1133-6-2	1133-6-3	150	12.0 x 4.0
1133-8	1133-8-00	1133-8-0	1133-8-1	1133-8-2	-	200	14.5 x 4.5
1133-10	1133-10-00	1133-10-0	1133-10-1	1133-10-2	-	250	17.5 x 5.3

PRECISION FILES - ULP

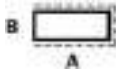

ULP1138 Thin Pillar

ULP	00	0	1	2	L mm	AxB mm
1138-6	1138-6-00	1138-6-0	1138-6-1	1138-6-2	150	10.5 x 2.4

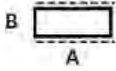

ULP1142 Slim pillar

ULP	00	0	1	2	3	4	6	L mm	AxB mm
1142-4	-	1142-4-0	-	1142-4-2	-	1142-4-4	-	100	4.6 x 2.2
1142-6	1142-6-00	1142-6-0	1142-6-1	1142-6-2	1142-6-3	1142-6-4	1142-6-6	150	6.5 x 3.0
1142-8	1142-8-00	1142-8-0	1142-8-1	1142-8-2	-	1142-8-4	-	200	8.3 x 3.5
1142-10	-	1142-10-0	-	1142-10-2	-	-	-	250	9.3 x 4.3

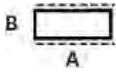

ULP1152 Extra-slim pillar

ULP	00	0	1	2	4	6	L mm	AxB mm
1152-4	1152-4-00	1152-4-0	-	1152-4-2	-	-	100	3.7 x 1.7
1152-6	1152-6-00	1152-6-0	1152-6-1	1152-6-2	1152-6-4	1152-6-6	150	4.5 x 2.5
1152-8	1152-8-00	1152-8-0	1152-8-1	1152-8-2	-	-	200	6.3 x 2.8
1152-10	1152-10-00	1152-10-0	-	1152-10-2	-	-	250	8.3 x 3.8

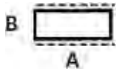

ULP1136 Chequering pillar

ULP	00	0	1	2	4	L mm	AxB mm
1136-6	1136-6-00	1136-6-0	1136-6-1	1136-6-2	1136-6-4	150	12.4 x 4.5



ULP1170 Joint file, rounds edges

ULP	2	L mm	A mm
1170-4	1170-4-2-0.4	100	10
1170-4	1170-4-2-0.5	100	10
1170-4	1170-4-2-0.6	100	10

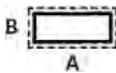

ULP1180 Equalling

ULP	00	0	1	2	4	L mm	AxB mm
1180-4	-	1180-4-0-2	-	1180-4-2-2	-	100	10.0 x 2.0
1180-5	-	-	1180-5-1-1.7	-	-	125	12.0 x 1.7
1180-6	1180-6-00-2	1180-6-0-2	-	1180-6-2-2	-	150	13.0 x 2.0
1180-6	1180-6-00-2.8	1180-6-0-2.8	-	1180-6-2-2.8	1180-6-4-2.8	150	13.0 x 2.8
1180-8	-	1180-8-0-3.2	-	1180-8-2-3.2	-	200	16.0 x 3.2

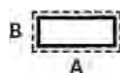

ULP1185 Equalling special

ULP	2	L mm	AxB mm
1185-4	1185-4-2-20	100	10.0 x 0.91
1185-4	1185-4-2-21	100	10.0 x 0.81
1185-4	1185-4-2-22	100	10.0 x 0.71
1185-4	1185-4-2-24	100	10.0 x 0.56
1185-4	1185-4-2-26	100	10.0 x 0.46
1185-4	1185-4-2-28	100	10.0 x 0.38



ULP1230 Crochet

ULP	0	2	L mm	AxB mm
1230-4	1230-4-0	1230-4-2	100	7.5 x 2.2
1230-6	1230-6-0	1230-6-2	150	10.0 x 3.1
1230-8	1230-8-0	-	200	12.5 x 4.2



ULP1263 Warding

ULP	0	2	4	L mm	AxB mm
1263-6-0	1263-6-0	1263-6-2	1263-6-4	150	15.4 x 3.5

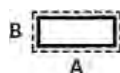

ULP1265 Warding special

ULP	0	L mm	AxB mm
1265-6	1265-6-0-16	150	15.4 x 1.65

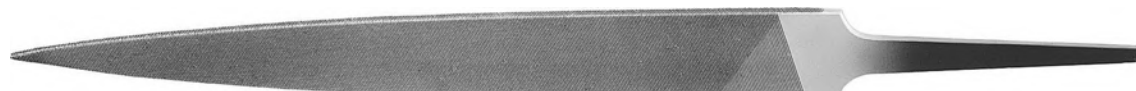
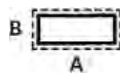

ULP1268 Warding thin

ULP	000	00	0	2	4	L mm	AxB mm
1268-4	-	1268-4-00	1268-4-0	1268-4-2	1268-4-4	100	12.4 x 1.0
1268-6	1268-6-000	1268-6-00	1268-6-0	1268-6-2	1268-6-4	150	15.4 x 1.7



ULP1312 Flat for aluminium

ULP	0	L mm	AxB mm
1312-6	1312-6-0	150	15.5 x 3.5
1312-8	1312-8-0	200	21.3 x 4.8
1312-10	1312-10-0	250	25.3 x 6.3



ULP1352 Halfround for aluminium

ULP	0	L mm	AxB mm
1352-6	1352-6-0	150	18.4 x 5.2
1352-10	1352-10-0	250	25.5 x 7.5



ULP1540 Double halfround for wax

ULP	L mm	AxB mm
1540-6	150	12.5 x 3.5
1540-7	175	12.5 x 3.5
1540-8	200	13.5 x 4.0



ULP1560 Halfround

ULP	000	00	0	1	2	3	4	5	6	L mm	AxB mm
1560-4	-	1560-4-00	1560-4-0	1560-4-1	1560-4-2	1560-4-3	1560-4-4	-	-	100	12.7 x 3.5
1560-5	-	1560-5-00	1560-5-0	1560-5-1	1560-5-2	1560-5-3	1560-5-4	1560-5-5	1560-5-6	125	13.1 x 4.1
1560-6	1560-6-000	1560-6-00	1560-6-0	1560-6-1	1560-6-2	1560-6-3	1560-6-4	1560-6-5	1560-6-6	150	15.1 x 4.7
1560-8	1560-8-000	1560-8-00	1560-8-0	1560-8-1	1560-8-2	1560-8-3	1560-8-4	-	-	200	21.1 x 6.3
1560-10	-	1560-10-00	1560-10-0	1560-10-1	-	-	-	-	-	250	25.5 x 7.5



ULP1566 Halfround slim for rings

ULP	000	00	0	1	2	3	4	L mm	AxB mm
1566-6	-	1566-6-00	1566-6-0	1566-6-1	1566-6-2	1566-6-3	1566-6-4	150	12.7 x 3.5
1566-8	1566-8-000	-	1566-8-0	1566-8-1	-	-	-	200	15.5 x 4.5
1566-10	-	1566-10-00	1566-10-0	-	1566-10-2	-	-	250	15.5 x 4.5



ULP1567 Halfround extra-slim

ULP	0	2	4	L mm	AxB mm
1567-6	1567-6-0	1567-6-2	1567-6-4	150	9.8 x 2.8



ULP1360 Triangular

ULP	000	00	0	1	2	3	4	L mm	A mm
1360-4	-	-	-	-	1360-4-2	-	1360-4-4	100	7.5
1360-6	1360-6-000	1360-6-00	1360-6-0	1360-6-1	1360-6-2	1360-6-3	1360-6-4	150	10.3
1360-8	1360-8-000	1360-8-00	1360-8-0	1360-8-1	1360-8-2	-	1360-8-4	200	14.2
1360-10	-	1360-10-00	-	1360-10-1	-	-	-	250	17.2



ULP1366 Triangular narrow

ULP	0	1	2	3	L mm	A mm
1366-4	-	-	1366-4-2	-	100	5.8
1366-6	1366-6-0	1366-6-1	1366-6-2	1366-6-3	150	8.3



ULP1367 Triangular extra narrow

ULP	0	2	L mm	A mm	Kg
1367-6	1367-6-0	1367-6-2	150	7.5	0.026



ULP1660 Round regular pointed

ULP	1	2	3	4	6	L mm	A mm
1660-4	-	1660-4-2	-	1660-4-4	-	100	3.9
1660-6	1660-6-1	1660-6-2	1660-6-3	1660-6-4	1660-6-6	150	5.9
1660-8	1660-8-1	1660-8-2	-	1660-8-4	-	200	7.8



ULP1667 Round extra narrow

ULP	0	1	L mm	A mm
1667-3	-	1667-3-1	75	1.5
1667-6	1667-6-0	-	150	3.9



ULP1669 Round cylindrical

ULP	0	2	L mm	A mm
1669-4	1669-4-0-1.6	1669-4-2-1.6	100	1.6
1669-4	1669-4-0-3	1669-4-2-3	100	3.0
1669-6	-	1669-6-2-2.4	150	2.4
1669-6	-	1669-6-2-3.2	150	3.2
1669-6	-	1669-6-2-4	150	4.0
1669-6	-	1669-6-2-4.8	150	4.8



ULP1670 Round



ULP	00	0	1	L mm	A mm
1670-4	1670-4-00	1670-4-0	-	100	3.9
1670-6	1670-6-00	1670-6-0	-	150	5.8
1670-8	1670-8-00	1670-8-0	-	200	7.5
1670-10	-	1670-10-0	1670-10-1	250	9.4



ULP1680 Round seconds hole



ULP	2	4	L mm	A mm
1680-1.5	1680-1.5-2	-	38	1.0
1680-2	1680-2-2	1680-2-4	50	1.0
1680-2.5	1680-2.5-2	-	62	1.6



ULP1464 Square pointed



ULP	1	2	3	L mm	A mm
1464-6	1464-6-1	1464-6-2	1464-6-3	150	5.5
1464-8	1464-8-1	1464-8-2	-	200	7.5



ULP1474 Square blunt



ULP	000	00	0	1	L mm	A mm
1474-4		1474-4-00	1474-4-0	-	100	3.6
1474-6		1474-6-00	1474-6-0	-	150	5.5
1474-8	1474-8-000	1474-8-00	1474-8-0	-	200	7.5
1474-10	1474-10-000	1474-10-00	1474-10-0	1474-10-1	250	9.4



ULP1480 Square seconds hole



ULP	4	L mm	A mm
1480-2	1480-2-4	50	1.0



ULP1040 Slotting



ULP	00	0	L mm	A mm
1040-10	1040-10-0-10	1040-10-00-10	250	9.5



ULP1060 Barrette

ULP	00	0	1	2	3	4	L mm	AxB mm
1060-4	1060-4-00	1060-4-0	1060-4-1	1060-4-2	-	-	100	12.4 x 2.6
1060-5	-	-	-	1060-5-2	-	-	125	14.0 x 3.0
1060-6	1060-6-00	1060-6-0	1060-6-1	1060-6-2	1060-6-3	1060-6-4	150	15.5 x 3.5
1060-8	1060-8-00	1060-8-0	1060-8-1	-	-	-	200	21.5 x 5.0



ULP1061 Special Barrette

ULP	1	4	6	L mm	AxB mm
1061-3	1061-3-1	1061-3-4	1061-3-6	75	9.0 x 1.8



ULP1730 Pippin

ULP	2	4	L mm	AxB mm
1730-6	1730-6-2	1730-6-4	150	10.0 x 4.4
1730-8	1730-8-2	-	200	11.5 x 4.9

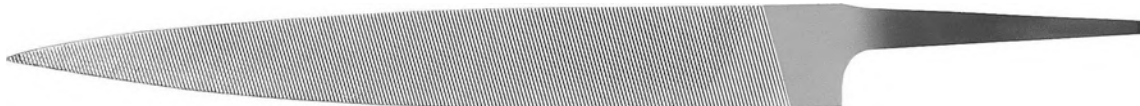
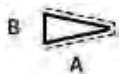

ULP1760 Knife

ULP	00	0	1	2	L mm	AxB mm
1760-4	-	-	-	1760-4-2	100	12.4 x 2.8
1760-6	1760-6-00	1760-6-0	-	1760-6-2	150	17.9 x 3.5
1760-8	1760-8-00	1760-8-0	1760-8-1	1760-8-2	200	22.0 x 4.2



ULP1840 Screwhead with tang

ULP	00	1	2	3	4	6	L mm	A mm
1840-3	-	-	1840-3-2	1840-3-3	1840-3-4	1840-3-6	75	9.0
1840-4	1840-4-00	1840-4-1	1840-4-2	-	1840-4-4	-	100	11.0



ULP1850 Screwhead without tang

ULP	4	5	8	L mm	A mm
1850-3	1850-3-4	1850-3-5	1850-3-8	75	9.0



ULP1960 Crossing

ULP	00	0	1	2	3	4	L mm	AxB mm
1960-3.5	-	-	-	1960-3.5-2	-	1960-3.5-4	90	10.2 x 2.9
1960-4	-	1960-4-0	-	1960-4-2	-	1960-4-4	100	11.9 x 3.6
1960-6	1960-6-00	1960-6-0	1960-6-1	1960-6-2	1960-6-3	1960-6-4	150	14.8 x 5.0
1960-8	1960-8-00	1960-8-0	1960-8-1	1960-8-2	-	-	200	21.3 x 6.3



ULP1990 Oval

ULP	0	2	L mm	AxB mm
1990-6	1990-6-0	1990-6-2	150	8.6 x 4.4

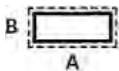

ULP1292 Warding

ULP	0	2	L mm	AxB mm
1292-6	1292-6-0	1292-6-2	150	10.5 x 2.4



ASSORTMENT

ULP	Kg
1095	1.550

Set of 37 files for mechanics.

ULA2401-180-2, ULA2402-180-0, ULA2403-160-2, ULA2405-160-0, ULA2406-160-00, ULA2409-160-2, ULA2410-180-0, ULA2411-160-1, ULH2601-00, ULH2602-00, ULH2607-00, ULH2608-00, ULH2610-00, ULH9602-0, ULO0653-4, ULP1060-8-1, ULP1133-8-2, ULP1163-8-000, ULP1263-6-2, ULP1360-6-00, ULP1360-8-00, ULP1464-6-2, ULP1474-8-0, ULP1560-6-4, ULP1560-8-4, ULP1670-6-0, ULP1670-8-00, ULP1730-6-2, ULP1960-4-2, ULP1960-8-1, ULR12711-2, ULR12730-2, ULR12741-2, ULR12781-0, ULR12901-2, ULR12918-2 and ULR12985-0.

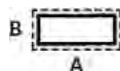

ULA2401 Pillar

ULA	00	0	1	2	3	4	6	L mm	AxB mm
2401-100	-	2401-100-0	2401-100-1	2401-100-2	2401-100-3	2401-100-4	-	100	3.5 x 0.9
2401-140	-	2401-140-0	2401-140-1	2401-140-2	2401-140-3	2401-140-4	2401-140-6	140	4.8 x 1.1
2401-160	2401-160-00	2401-160-0	2401-160-1	2401-160-2	2401-160-3	2401-160-4	2401-160-6	160	5.4 x 1.2
2401-180	2401-180-00	2401-180-0	2401-180-1	2401-180-2	2401-180-3	2401-180-4	2401-180-6	180	6.0 x 1.3
2401-200	2401-200-00	2401-200-0	2401-200-1	2401-200-2	2401-200-3	2401-200-4	-	200	6.5 x 1.3



ULA2402 Halfround

ULA	00	0	1	2	3	4	6	L mm	AxB mm
2402-100	-	2402-100-0	-	2402-100-2	2402-100-3	2402-100-4	-	100	3.8 x 1.1
2402-140	-	2402-140-0	2402-140-1	2402-140-2	2402-140-3	2402-140-4	-	140	5.1 x 1.5
2402-160	2402-160-00	2402-160-0	2402-160-1	2402-160-2	2402-160-3	2402-160-4	2402-160-6	160	5.6 x 1.7
2402-180	2402-180-00	2402-180-0	2402-180-1	2402-180-2	2402-180-3	2402-180-4	-	180	5.9 x 2.0
2402-200	2402-200-00	2402-200-0	2402-200-1	2402-200-2	2402-200-3	2402-200-4	-	200	6.3 x 2.0



ULA2403 Crossing

ULA	0	1	2	3	4	6	L mm	AxB mm
2403-100	-	-	2403-100-2	2403-100-3	2403-100-4	-	100	3.5 x 1.4
2403-140	2403-140-0	2403-140-1	2403-140-2	-	2403-140-4	-	140	4.4 x 1.8
2403-160	2403-160-0	2403-160-1	2403-160-2	-	2403-160-4	2403-160-6	160	5.1 x 2.0
2403-180	2403-180-0	2403-180-1	2403-180-2	-	2403-180-4	-	180	5.8 x 2.2
2403-200	2403-200-0	2403-200-1	2403-200-2	2403-200-3	2403-200-4	-	200	6.0 x 2.4



ULA2405 Knife

ULA	0	1	2	3	4	6	L mm	AxB mm
2405-100	-	2405-100-1	2405-100-2	2405-100-3	2405-100-4	-	100	4.0 x 1.1
2405-140	2405-140-0	2405-140-1	2405-140-2	-	2405-140-4	-	140	5.0 x 1.4
2405-160	2405-160-0	2405-160-1	2405-160-2	-	2405-160-4	2405-160-6	160	5.4 x 1.5
2405-180	2405-180-0	2405-180-1	2405-180-2	-	-	-	180	6.0 x 1.7
2405-200	2405-200-0	2405-200-1	2405-200-2	2405-200-3	2405-200-4	-	200	6.4 x 1.8

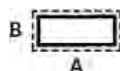

ULA2406 Warding

ULA	00	0	1	2	3	4	6	L mm	AxB mm
2406-100	-	-	-	2406-100-2	2406-100-3	2406-100-4	-	100	3.4 x 0.9
2406-140	-	2406-140-0	2406-140-1	2406-140-2	2406-140-3	2406-140-4	-	140	4.8 x 1.1
2406-160	2406-160-00	2406-160-0	2406-160-1	2406-160-2	2406-160-3	2406-160-4	2406-160-6	160	5.4 x 1.2
2406-180	-	2406-180-0	2406-180-1	2406-180-2	-	2406-180-4	-	180	6.0 x 1.2
2406-200	-	2406-200-0	2406-200-1	2406-200-2	-	2406-200-4	-	200	6.5 x 1.4



ULA2407 Triangular

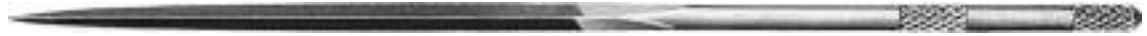

ULA	00	0	1	2	3	4	6	L mm	A mm
2407-100	-	2407-100-0	2407-100-1	2407-100-2	2407-100-3	2407-100-4	-	100	2.8
2407-140	-	2407-140-0	2407-140-1	2407-140-2	2407-140-3	2407-140-4	2407-140-6	140	3.5
2407-160	2407-160-00	2407-160-0	2407-160-1	2407-160-2	2407-160-3	2407-160-4	2407-160-6	160	3.8
2407-180	2407-180-00	2407-180-0	2407-180-1	2407-180-2	2407-180-3	2407-180-4	-	180	4.2
2407-200	2407-200-00	2407-200-0	2407-200-1	2407-200-2	2407-200-3	2407-200-4	-	200	4.4



ULA2408 Square



ULA	00	0	1	2	3	4	6	L mm	A mm
2408-100	-	2408-100-0	2408-100-1	2408-100-2	2408-100-3	2408-100-4	-	100	1.7
2408-140	-	2408-140-0	2408-140-1	2408-140-2	2408-140-3	2408-140-4	-	140	2.2
2408-160	2408-160-00	2408-160-0	2408-160-1	2408-160-2	2408-160-3	2408-160-4	2408-160-6	160	2.4
2408-180	2408-180-00	2408-180-0	2408-180-1	2408-180-2	2408-180-3	2408-180-4	-	180	2.6
2408-200	2408-200-00	2408-200-0	2408-200-1	2408-200-2	2408-200-3	2408-200-4	-	200	2.8



ULA2409 Oval



ULA	0	1	2	4	L mm	AxB mm
2409-140	2409-140-0	2409-140-1	2409-140-2	2409-140-4	140	3.5 x 2.4
2409-160	2409-160-0	2409-160-1	2409-160-2	2409-160-4	160	3.9 x 2.5
2409-180	2409-180-0	-	2409-180-2	-	180	4.2 x 2.8
2409-200	2409-200-0	-	-	-	200	4.4 x 2.9



ULA2410 Round



ULA	00	0	1	2	3	4	6	L mm	A mm
2410-100	-	2410-100-0	2410-100-1	2410-100-2	2410-100-3	2410-100-4	-	100	2.1
2410-140	2410-140-00	2410-140-0	2410-140-1	2410-140-2	2410-140-3	2410-140-4	2410-140-6	140	2.8
2410-160	2410-160-00	2410-160-0	2410-160-1	2410-160-2	2410-160-3	2410-160-4	2410-160-6	160	2.9
2410-180	2410-180-00	2410-180-0	2410-180-1	2410-180-2	2410-180-3	2410-180-4	-	180	3.2
2410-200	2410-200-00	2410-200-0	2410-200-1	2410-200-2	2410-200-3	2410-200-4	-	200	3.5



ULA2411 Barrette



ULA	00	0	1	2	3	4	6	L mm	AxB mm
2411-100	-	2411-100-0	-	2411-100-2	2411-100-3	2411-100-4	-	100	3.7 x 1.4
2411-140	-	2411-140-0	2411-140-1	2411-140-2	2411-140-3	2411-140-4	-	140	4.7 x 1.7
2411-160	2411-160-00	2411-160-0	2411-160-1	2411-160-2	2411-160-3	2411-160-4	2411-160-6	160	5.1 x 1.8
2411-180	2411-180-00	2411-180-0	2411-180-1	2411-180-2	2411-180-3	2411-180-4	-	180	5.4 x 2.0
2411-200	2411-200-00	2411-200-0	2411-200-1	2411-200-2	2411-200-3	2411-200-4	-	200	5.8 x 2.2



ULA2414 Slitting

ULA	0	1	2	3	4	6	L mm	AxB mm
2414-140	2414-140-0	2414-140-1	2414-140-2	2414-140-3	2414-140-4	-	140	5.5 x 1.9
2414-160	2414-160-0	2414-160-1	2414-160-2	-	2414-160-4	2414-160-6	160	6.1 x 2.1



ULA2415 Crochet

ULA	0	1	2	4	6	L mm	AxB mm
2415-140	2415-140-0	2415-140-1	2415-140-2	2415-140-4	-	140	4.8 x 1.2
2415-160	2415-160-0	2415-160-1	2415-160-2	2415-160-4	2415-160-6	160	5.4 x 1.3
2415-180	2415-180-0	-	2415-180-2	-	-	180	5.9 x 1.4
2415-200	2415-200-0	-	-	-	-	200	6.5 x 1.5



ULA2416 Pillar round edges

ULA	0	1	2	3	4	L mm	AxB mm
2416-140	2416-140-0	2416-140-1	2416-140-2	-	2416-140-4	140	4.8 x 1.2
2416-160	2416-160-0	2416-160-1	2416-160-2	-	2416-160-4	160	5.4 x 1.3
2416-180	2416-180-0	-	2416-180-2	-	-	180	6.0 x 1.4
2416-200	2416-200-0	2416-200-1	-	-	-	200	6.5 x 1.5



ULA2417 Joint round edges

ULA	0	2	4	L mm	AxB mm
2417-140	-	2417-140-2	2417-140-4	140	4.8 x 1.2
2417-160	2417-160-0	2417-160-2	2417-160-4	160	5.4 x 1.3



ULA2418 Halfround, cut on back only

ULA	0	2	4	L mm	AxB mm
2418-140	2418-140-0	2418-140-2	2418-140-4	140	5.1 x 1.5
2418-160	2418-160-0	2418-160-2	2418-160-4	160	5.6 x 1.8

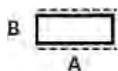

ULA2420 For contact

ULA	0	2	L mm	AxB mm
2420-130	2420-130-0	2420-130-2	130	8.0 x 0.9



ULA2423 Round extra slim

ULA	0	1	2	L mm	A mm
2423-100	-	2423-100-1	2423-100-2	100	1.0



ASSORTMENT

ULA	L mm	Kg
2400-A	160	0.111

Assortment of 12 needle files ULA2400-A :

ULA2401-160-4, ULA2402-160-4, ULA2403-160-4, ULA2405-160-4, ULA2406-160-3, ULA2407-160-4, ULA2408-160-4, ULA2409-160-4, ULA2410-160-4, ULA2411-160-4, ULA2416-160-2 and ULA2418-160-2.

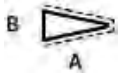

ULE3004 Pointed knife



ULE	2	4	6	8	L mm	AxB mm
3004-55	3004-55-2	3004-55-4	3004-55-6	3004-55-8	55	5.0 x 1.3



ULE3008 Halfround



ULE	2	3	4	5	6	8	10	L mm	AxB mm
3008-40	3008-40-2	-	3008-40-4	-	3008-40-6	3008-40-8	-	40	3.8 x 1.4
3008-55	3008-55-2	3008-55-3	3008-55-4	3008-55-5	3008-55-6	3008-55-8	3008-55-10	55	4.6 x 1.6



ULE3009 Crossing



ULE	2	4	6	8	10	L mm	AxB mm
3009-40	3009-40-2	3009-40-4	3009-40-6	3009-40-8	-	40	3.7 x 1.4
3009-55	3009-55-2	3009-55-4	3009-55-6	3009-55-8	3009-55-10	55	4.8 x 1.6



ULE3010 Barrette



ULE	0	2	3	4	5	6	8	10	L mm	AxB mm
3010-40	-	3010-40-2		3010-40-4		3010-40-6	3010-40-8	-	40	3.7 x 1.3
3010-55	3010-55-0	3010-55-2	3010-55-3	3010-55-4	3010-55-5	3010-55-6	3010-55-8	3010-55-10	55	4.5 x 1.3



ULE3011 Parallel barrette



ULE	2	4	6	L mm	AxB mm
3011-48	3011-48-2	3011-48-4	3011-48-6	48	4.1 x 1.2



ULE3012 Rounding off



ULE	2	4	6	L mm	AxB mm
3012-40	3012-40-2	3012-40-4	3012-40-6	40	3.6 x 0.8



ULE3014 Triangular



ULE	0	2	3	4	5	6	8	10	L mm	A mm
3014-40	-	3014-40-2	-	3014-40-4	-	3014-40-6			40	2.8
3014-55	3014-55-0	3014-55-2	3014-55-3	3014-55-4	3014-55-5	3014-55-6	3014-55-8	3014-55-10	55	3.4

ESCAPEMENT FILES - ULE



ULE3015 Watch anchor



ULE	6	8	L mm	AxB mm
3015-55	3015-55-6	3015-55-8	55	4.4 x 0.8

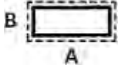

ULE3016 Warding



ULE	4	L mm	AxB mm
3016-55	3016-55-4	55	4.6 x 0.9

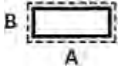

ULE3017 Pillar



ULE	2	4	6	8	10	L mm	AxB mm
3017-55	3017-55-2	3017-55-4	3017-55-6	3017-55-8	3017-55-10	55	5.0 x 0.9



ULE3020 Square



ULE	0	2	3	4	5	6	8	10	L mm	A mm
3020-55	3020-55-0	3020-55-2	3020-55-3	3020-55-4	3020-55-5	3020-55-6	3020-55-8	3020-55-10	55	1.7
3020-65	-	3020-65-2	-	3020-65-4	-	3020-65-6	3020-65-8	-	65	1.9



ULE3021 Round



ULE	0	2	3	4	6	8	10	L mm	A mm
3021-55	3021-55-0	3021-55-2	3021-55-3	3021-55-4	3021-55-6	3021-55-8	3021-55-10	55	1.5
3021-65	-	3021-65-2	-	3021-65-4	3021-65-6	3021-65-8	-	65	2.0



ULE3026 Balance wheel



ULE	4	6	10	L mm	AxB mm
3026-35	3026-35-4	3026-35-6	3026-35-10	35	2.9 x 1.2

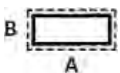

ULE3029 Equalling



ULE	2	4	6	L mm	AxB mm
3029-55	3029-55-2-DT	3029-55-4-DT	3029-55-6-DT	55	4.7 x 0.7



ASSORTMENT

ULE	10	L mm	Kg
3080	3080-10	55	?

Assortment of 6 escapement files ULE3080 :

ULE3008, ULE3010, ULE3014, ULE3017, ULE3020 et ULE3021.



ASSORTMENT

ULE	4	6	L mm	Kg
3092	3092-4	3092-6	55	0.060

Assortment of 12 escapement files ULE3092 :

ULE3004, ULE3008, ULE3009, ULE3010, ULE3011, ULE3014, ULE3016, ULE3017, ULE3020, ULE3021, ULE3026 and ULE3029.



ASSORTMENT

ULE	L mm	Kg
3000-A	35 - 40 - 48 - 55	0.069

Assortment of 12 escapement files ULA3000-A :

ULE3008-40-8, ULE3009-40-8, ULE3010-40-6, ULE3010-55-6, ULE3011-48-4, ULE3014-55-6, ULE3016-55-4, ULE3017-55-4, ULE3020-55-6, ULE3021-55-8, ULE3021-55-10 and ULE3026-35-4.

Buff files (needle files).

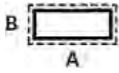

ULAC2401 Pillar

ULAC	G10	L mm	AxB mm
2401-140	2401-140-G10	140	4.8 x 1.0



ULAC2402 Halfround

ULAC	G10	L mm	AxB mm
2402-140	2402-140-G10	140	5.1 x 1.6



ULAC2403 Crossing

ULAC	G10	L mm	AxB mm
2403-140	2403-140-G10	140	4.4 x 1.8



ULAC2407 Triangular

ULAC	G10	L mm	A mm
2407-140	2407-140-G10	140	3.5



ULAC2408 Square

ULAC	G10	L mm	A mm
2408-140	2408-140-G10	140	2.2



ULAC2410 Round

ULAC	G10	L mm	A mm
2410-140	2410-140-G10	140	2.8



ULAC2411 Barrette

ULAC	G10	L mm	AxB mm
2411-140	2411-140-G10	140	4.7 x 1.4



ULAC	G10	L mm	Kg
2462	2462-140-G10	140	?

Assortment of 6 buff files ULAC2462 :

ULAC2401, ULAC2402, ULAC2403, ULAC2407, ULAC2410 and ULAC2411.

ASSORTMENT

Buff files (escapement files).



ULEC3008 Halfround

ULEC	G10	L mm	AxB mm
3008-55	3008-55-G10	55	4.0 x 1.3



ULEC3009 Crossing

ULEC	G10	L mm	AxB mm
3009-55	3009-55-G10	55	3.7 x 1.4



ULEC3010 Barrette

ULEC	G10	L mm	AxB mm
3010-55	3010-55-G10	55	3.9 x 1.2



ULEC3014 Triangular



ULEC	G10	L mm	A mm
3014-55	3014-55-G10	55	2.8

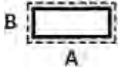

ULEC3017 Pillar



ULEC	G10	L mm	AxB mm
3017-55	3017-55-G10	55	3.6 x 0.8



ULEC3020 Square



ULEC	G10	L mm	A mm
3020-55	3020-55-G10	55	1.7



ULEC3021 Round



ULEC	G10	L mm	A mm
3021-55	3021-55-G10	55	1.5



ULEC	G10	L mm	Kg
3062	3062-55-G10	55	0.026

Assortment of 6 buff files ULEC3062 :

ULEC3008, ULEC3009, ULEC3010, ULEC3014, ULEC3017 and ULEC3021.

Diamond needle files.

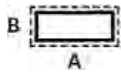

UDA8401 Pillar



UDA	91	126	L mm	AxB mm
8401	8401-91	8401-126	140	4.8 x 1.1



UDA8402 Halfround



UDA	91	126	L mm	AxB mm
8402	8402-91	8402-126	140	5.1 x 1.5



UDA8407 Triangular



UDA	91	126	L mm	A mm
8407	8407-91	8407-126	140	3.5



UDA8408 Square



UDA	G10	91	L mm	A mm
8408	8408-91	8408-126	140	2.2



UDA8410 Round



UDA	91	126	L mm	A mm
8410	8410-91	8410-126	140	2.8



UDA8411



UDA	91	126	L mm	AxB mm
8411	-	8411-126	140	4.7 x 1.7



ASSORTMENT

UDA	91	126	L mm	Kg
8432	8432-91	8432-126	140	0.035

Assortment of 5 diamond needle files UDA8432 :

UDA8401, UDA8402, UDA8407, UDA8408 and UDA8410.

DIAMOND FILES - UDA

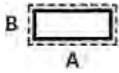

UDA9401 Pillar



UDA	91	L mm	AxB mm
9401	9401-91	140	4.8 x 1.1



UDA9402 Halfround



UDA	91	L mm	AxB mm
9402	9402-91	140	5.1 x 1.5



UDA9407 Triangular



UDA	91	L mm	A mm
9407	9407-91	140	3.5



UDA9408 Square



UDA	91	L mm	A mm
9408	9408-91	140	2.2



UDA9410 Round



UDA	91	L mm	A mm
9410	9410-91	140	2.8



ASSORTMENT

UDA	91	L mm	Kg
9470	9470-91	140	0.035

Assortment of 5 diamond needle files UDA9470 :
UDA9401, UDA9402, UDA9407, UDA9408 and UDA9410.

Diamond foils.



UDD	Grit	Size	Kg
8800-300	300	100 x 50 mm	0.001
8800-600	600	100 x 50 mm	0.001
8800-1000	1000	100 x 50 mm	0.001

VALDIAMOND diamond foil.
Grains 300 and 600 : universal use
Grain 1000 : for finishing

Ceramic fibre files.

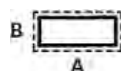

ULF0502 - ULF1002 - ULF0504 - ULF1004 Pillar (grain 120...800)

ULF	Grit 120	Grit 220	Grit 300	Grit 400	Grit 600	Grit 800	L mm	AxB mm
0502	-	-	0502-M-300	0502-M-400	0502-M-600	0502-M-800	100	2.0 x 0.5
1002	1002-M-120	1002-M-220	1002-M-300	1002-M-400	1002-M-600	1002-M-800	100	2.0 x 1.0
0504	-	0504-M-220	0504-M-300	0504-M-400	0504-M-600	0504-M-800	100	4.0 x 0.5
1004	1004-M-120	1004-M-220	1004-M-300	1004-M-400	1004-M-600	1004-M-800	100	4.0 x 1.0

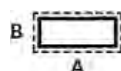

ULF0502 - ULF1002 - ULF0504 - ULF1004 Pillar (grain 1000...3000)

ULF	Grit 1000	Grit 1200	Grit 1500	Grit 2000	Grit 3000	L mm	AxB mm
0502	0502-M-1000	0502-M-1200	-	-	-	100	2.0 x 0.5
1002	1002-M-1000	1002-M-1200	1002-M-1500	1002-M-2000	1002-M-3000	100	2.0 x 1.0
0504	0504-M-1000	0504-M-1200	-	-	-	100	4.0 x 0.5
1004	1004-M-1000	1004-M-1200	1004-M-1500	-	-	100	4.0 x 1.0



ULF234 - ULF30 Round (grain 220...800)

ULF	Grit 120	Grit 220	Grit 300	Grit 400	Grit 600	Grit 800	L mm	A mm
234	-	234-S-220	234-S-300	234-S-400	234-S-600	234-S-800	50	2.34
30	-	30-S-220	30-S-300	30-S-400	30-S-600	30-S-800	50	3.0



ULF234 - ULF30 Round (grain 1000...1200)

ULF	Grit 1000	Grit 1200	Grit 1500	Grit 2000	Grit 3000	L mm	A mm
234	234-S-1000	234-S-1200	-	-	-	50	2.34
30	30-S-1000	30-S-1200	-	-	-	50	3.0



ULF0505 - ULF0909 - ULF1001 Square (grain 220...800)

ULF	Grit 120	Grit 220	Grit 300	Grit 400	Grit 600	Grit 800	L mm	A mm
0505	-	-	-	-	-	0505-S-800	50	0.5
0909	-	-	-	-	-	0909-S-800	50	0.9
1001	-	1001-M-220	1001-M-300	1001-M-400	1001-M-600	1001-M-800	100	1.0



ULF0505 - ULF0909 - ULF1001 Square (grain 1000...3000)

ULF	Grit 1000	Grit 1200	Grit 1500	Grit 2000	Grit 3000	L mm	A mm
0505	-	0505-S-1200	-	-	-	50	0.5
0909	-	0909-S-1200	-	-	-	50	0.9
1001	1001-M-1000	1001-M-1200	1001-M-1500	1001-M-2000	1001-M-3000	100	1.0

Gravers.



ULO0401 Flat edge

ULO	HSS L = 65 mm	WS L = 80 mm	A mm
0401-2	0401-2-HSS	0401-2-WS	0.2
0401-4	0401-4-HSS	0401-4-WS	0.4
0401-6	0401-6-HSS	0401-6-WS	0.6
0401-8	0401-8-HSS	0401-8-WS	0.8
0401-10	0401-10-HSS	0401-10-WS	1.0
0401-12	0401-12-HSS	0401-12-WS	1.2
0401-14	0401-14-HSS	0401-14-WS	1.4
0401-16	0401-16-HSS	0401-16-WS	1.6
0401-18	0401-18-HSS	-	1.8
0401-20	0401-20-HSS	-	2.0



ULO0402 Round edge

ULO	HSS L = 65 mm	WS L = 80 mm	A mm
0402-2	0402-2-HSS	0402-2-WS	0.2
0402-4	0402-4-HSS	0402-4-WS	0.4
0402-6	0402-6-HSS	0402-6-WS	0.6
0402-8	0402-8-HSS	0402-8-WS	0.8
0402-10	0402-10-HSS	0402-10-WS	1.0
0402-12	0402-12-HSS	0402-12-WS	1.2
0402-16	0402-16-HSS	-	1.6



ULO0403 Onglette

ULO	HSS L = 65 mm	WS L = 80 mm	A mm
0403-5/0	0403-5/0-HSS	-	1.16
0403-4/0	0403-4/0-HSS	-	1.24
0403-3/0	0403-3/0-HSS	-	1.35
0403-2/0	0403-2/0-HSS	0403-2/0-WS	1.45
0403-0	0403-0-HSS	0403-0-WS	1.58
0403-1	0403-1-HSS	0403-1-WS	1.78
0403-2	0403-2-HSS	0403-2-WS	1.94
0403-3	0403-3-HSS	0403-3-WS	2.16
0403-4	0403-4-HSS	0403-4-WS	2.54
0403-5	0403-5-HSS	-	2.74
0403-6	0403-6-HSS	-	2.94
0403-8	0403-8-HSS	-	3.36

GRAVERS / WATCHMAKERS' GRAVERS - ULO



ULO0406 Knife

ULO	HSS L = 65 mm	WS L = 80 mm	A mm
0406-18	0406-18-HSS	0406-18-WS	1.8
0406-20	0406-20-HSS	0406-20-WS	2.0
0406-22	0406-22-HSS	0406-22-WS	2.2
0406-24	0406-24-HSS	-	2.4
0406-26	0406-26-HSS	0406-26-WS	2.6
0406-30	-	0406-30-WS	3.0



ULO0404 Oval

ULO	HSS L = 65 mm	WS L = 80 mm	A mm
0404-21	-	0404-21	2.1



ULO0405 Bevelled

ULO	HSS L = 65 mm	WS L = 80 mm	A mm
0405-12	-	0405-12	1.2

Watchmakers' gravers.



ULO0501 Square

ULO	HSS L = 110 mm	WS L = 110 mm	A mm
0501-1.50	-	0501-1.50-WS	1.5
0501-2	-	0501-2-WS	2.0
0501-2.25	0501-2.25-HSS	-	2.25
0501-2.5	0501-2.5-HSS	0501-2.5-WS	5.5
0501-2.75	0501-2.75-HSS	-	2.75
0501-3	0501-3-HSS	0501-3-WS	3.0
0501-3.5	0501-3.5-HSS	-	3.5
0501-4	0501-4-HSS	-	4.0



ULO0502 Lozenge

ULO	HSS L = 110 mm	WS L = 110 mm	A mm
0502-1.75	-	0502-1.75	1.75
0502-2	-	0502-2	2.0
0502-2.5	-	0502-2.5	2.5

Scrapers.

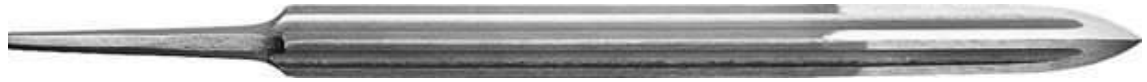

ULO0653 Triangular

ULO	L mm	A mm
0653-2	50	5.0
0653-3	75	7.0



ULO0655 Incurved

ULO	L mm	A mm
0655-2	50	6.0

Burnishers.



ULO0788 Oval straight

ULO	L mm	AxB mm
0788-3	75	6.5 x 3.5
0788-4	100	8.0 x 4.2

HABILIS® files.

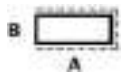

ULH2601 Pillar

ULH	00	1	L mm	AxB mm
2601	2601-00	2601-1	215	10.0 x 2.6



ULH2602 Halfround

ULH	00	1	L mm	AxB mm
2602	2602-00	2602-1	215	12.2 x 3.4



ULH2607 Triangular

ULH	00	1	L mm	A mm
2607	2607-00	2607-1	215	9.5



ULH2608 Square

ULH	00	1	L mm	A mm
2608	2608-00	2608-1	215	6



ULH2610 Round

ULH	00	1	L mm	A mm
2610	2610-00	2610-1	215	6.5

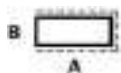

ULH2901 Pillar Multifile

ULH	00	1	L mm	AxB mm
2901	2901-00	-	215	10.0 x 3.2



ULH	00	1	L mm	Kg
2627	2627-00	2627-1	215	0.233

Assortment of 5 HABILIS® files ULH2627 :

ULH2601, ULH2602, ULH2607, ULH2608 and ULH2610.

ASSORTMENT (BLISTER)



ASSORTMENT (POUCH)

ULH	00	1	L mm	Kg
2630	2630-00	2630-1	215	0.233

Assortment of 5 HABILIS® files ULH2630 :
 ULH2601, ULH2602, ULH2607, ULH2608 and ULH2610.

VALTITAN® files.

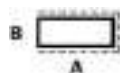

ULPV1163 Hand

ULPV	000	00	0	2	L mm	AxB mm
1163-6	-	1163-6-00	1163-6-0	1163-6-2	150	18.5 x 4.0
1163-8	-	1163-8-00	1163-8-0	1163-8-2	200	21.3 x 4.8
1163-10	1163-10-000	1163-10-00	1163-10-0	-	250	25.3 x 6.3

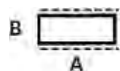

ULPV1132 Pillar 2 sides

ULPV	0	2	L mm	AxB mm
1132-6	1132-6-0	1132-6-2	150	12.0 x 4.0
1132-8	1132-8-0	1132-8-2	200	14.5 x 4.5



ULPV1560 Halfround

ULPV	0	2	L mm	AxB mm
1560-6	1560-6-0	1560-6-2	150	15.1 x 4.7
1560-8	1560-8-0	1560-8-2	200	21.1 x 6.3



ULPV1360 Triangular

ULPV	0	2	L mm	A mm
1360-8	1360-8-0	1360-8-2	200	14.2



ULPV1660 Pointed round

ULPV	2	L mm	A mm
1660-8	1660-8-2	200	7.8

SPECIAL FILES - ULH / ULPV / ULAV / ULR / URA



ULPV1670 Round blunt



ULPV	0	L mm	A mm
1670-8	1670-8-0	200	7.5



ULPV1060 Barrette



ULPV	0	L mm	AxB mm
1060-6	1060-6-0	150	15.5 x 3.5

VALTITAN® needle files.



ULAV2407 Triangular



ULAV	0	2	L mm	A mm	Kg
2407-180	2407-180-0	2407-180-2	180	4.2	?



ULAV2410 Round



ULAV	0	2	L mm	A mm	Kg
2410-180	2410-180-0	2410-180-2	180	3.2	0.009



ULAV2411 Barrette



ULAV	0	L mm	AxB mm	Kg
2411-180	2411-180-0	180	5.4 x 2.0	0.011



ULAV	2	L mm	Kg
2465	2465-2	180	0.060

Assortment of 6 needle files ULAV2465 :

ULAV2401, ULAV2402, ULAV2407, ULAV2408, ULAV2410 and ULAV2411.

ASSORTMENT (BLISTER)



ULAV	2	L mm	Kg
2495	2495-2	180	0.060

Assortment of 6 needle files ULAV2465 :

ULAV2401, ULAV2402, ULAV2407, ULAV2408, ULAV2410 and ULAV2411.

ASSORTMENT (POUCH)

Rifflers 150 mm.



ULR12901 Barrette

ULR	0	2	L mm	AxB mm
12901	12901-0	12901-2	150	3.8 x 1.2

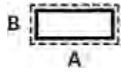

ULR12905 Pointed hand

ULR	0	2	L mm	AxB mm
12905	12905-0	12905-2	150	2.0 x 1.2

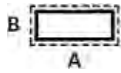

ULR12910 Hand

ULR	0	2	L mm	AxB mm
12910	12910-0	12910-2	150	2.0 x 1.2

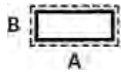

ULR12911 Hand

ULR	0	2	L mm	AxB mm
12911	12911-0	12911-2	150	2.0 x 1.2

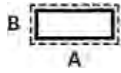

ULR12912 Hand

ULR	0	2	L mm	AxB mm
12912	12912-0	12912-2	150	2.6 x 1.5

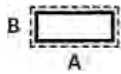

ULR12913 Hand

ULR	0	2	L mm	AxB mm
12913	12913-0	12913-2	150	2.6 x 1.5

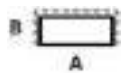

ULR12914 Pointed hand

ULR	0	2	L mm	AxB mm
12914	12914-0	12914-2	150	3.4 x 1.5



ULR12915 Pointed hand

ULR	0	2	L mm	AxB mm
12915	12915-0	12915-2	150	3.4 x 1.5

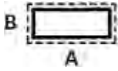

ULR12916 Hand

ULR	0	2	L mm	AxB mm
12916	-	12916-2	150	3.0 x 3.0

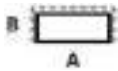

ULR12917 Hand

ULR	0	2	L mm	AxB mm
12917	12917-0	12917-2	150	3.0 x 3.0

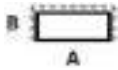

ULR12918 Hand

ULR	0	2	L mm	AxB mm
12918	12918-0	12918-2	150	3.8 x 1.6



ULR12930 Square

ULR	0	2	L mm	A mm
12930	12930-0	12930-2	150	2.5



ULR12940 Triangular

ULR	0	2	L mm	A mm
12940	12940-0	12940-2	150	2.0



ULR12942 Triangular

ULR	0	2	L mm	A mm
12942	12942-0	12942-2	150	3.0



ULR12943 Triangular

ULR	0	2	L mm	A mm
12943	12943-0	12943-2	150	3.4



ULR12951 Knife

ULR	0	2	L mm	AxB mm
12951	12951-0	12951-2	150	4.4 x 1.2



ULR12952 Knife

ULR	0	2	L mm	AxB mm
12952	12952-0	12952-2	150	4.4 x 1.2



ULR12955 Pippin

ULR	0	2	L mm	AxB mm
12955	12955-0	12955-2	150	4.7 x 1.3

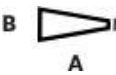

ULR12956 Knife flat edge

ULR	0	2	L mm	AxB mm
12956	12956-0	12956-2	150	4.4 x 1.2

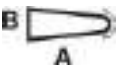

ULR12957 Knife round edge

ULR	0	2	L mm	AxB mm
12957	12957-0	12957-2	150	4.4 x 1.2



ULR 12961 Halfround

ULR	0	2	L mm	AxB mm
12961	12961-0	12961-2	150	4.5 x 2.2



ULR12963 Halfround

ULR	0	2	L mm	AxB mm
12963	12963-0	12963-2	150	4.6 x 1.5



ULR12964 Halfround

ULR	0	2	L mm	AxB mm
12964	12964-0	12964-2	150	4.6 x 1.4



ULR12965 Halfround cut on hand

ULR	0	2	L mm	AxB mm
12965	12965-0	12965-2	150	5.0 x 1.9



ULR12970 Crossing

ULR	0	2	L mm	AxB mm
12970	12970-0	12970-2	150	1.7 x 1.2



ULR12972 Crossing

ULR	0	2	L mm	AxB mm
12972	12972-0	12972-2	150	3.8 x 1.8



ULR12973 Crossing

ULR	0	2	L mm	AxB mm
12973	12973-0	12973-2	150	3.8 x 1.8



ULR12974 Crossing

ULR	0	2	L mm	AxB mm
12974	12974-0	12974-2	150	3.8 x 1.8



ULR12975 Crossing

ULR	0	2	L mm	AxB mm
12975	12975-0	12975-2	150	4.0 x 1.9



ULR12981 Round

ULR	0	2	L mm	A mm
12981	12981-0	12981-2	150	3.1



ULR12982 Pompon

ULR	0	2	L mm	A mm
12982	12982-0	12982-2	150	3.0



ULR12983 Round

ULR	0	2	L mm	A mm
12983	12983-0	12983-2	150	3.2

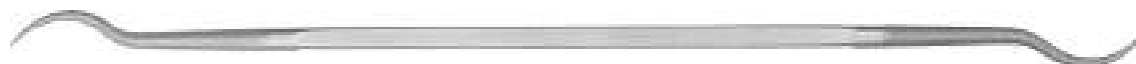

ULR12984 Round

ULR	0	2	L mm	A mm
12984	12984-0	12984-2	150	3.1



ULR12985 Round

ULR	0	2	L mm	A mm
12985	12985-0	12985-2	150	3.2



ULR12986 Round

ULR	0	2	L mm	A mm
12986	12986-0	12986-2	150	2.6



ULR12987 Round

ULR	0	2	L mm	A mm
12987	12987-0	12987-2	150	3.2



ULR12996 Oval

ULR	0	2	L mm	AxB mm
12996	12996-0	12996-2	150	1.9 x 1.4

Rifflers 180 mm.

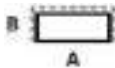

ULR12710 Hand

ULR	0	2	L mm	AxB mm
12710	12710-0	12710-2	180	8.3 x 2.4

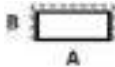

ULR12711 Hand

ULR	0	2	L mm	AxB mm
12711	12711-0	12711-2	180	8.3 x 2.4

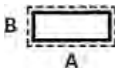

ULR12712 Pointed hand

ULR	0	2	L mm	AxB mm
12712	12712-0	12712-2	180	8.3 x 2.4



ULR12713 Warding

ULR	0	2	L mm	AxB mm
12713	12713-0	12713-2	180	8.3 x 2.4



ULR12731 Square

ULR	0	2	L mm	A mm
12731	12731-0	12731-2	180	4.8



ULR12732 Square

ULR	0	2	L mm	A mm
12732	12732-0	12732-2	180	4.6



ULR12741 Triangular

ULR	0	2	L mm	A mm
12741	12741-0	12741-2	180	7.4



ULR12750 Knife

ULR	0	2	L mm	AxB mm
12750	12750-0	12750-2	180	10.4 x 2.7



ULR12761 Halfround

ULR	0	2	L mm	AxB mm
12761	12761-0	12761-2	180	9.5 x 3.8



ULR12762 Halfround

ULR	0	2	L mm	AxB mm
12762	12762-0	12762-2	180	9.0 x 3.7



ULR12763 Halfround

ULR	0	2	L mm	AxB mm
12763	12763-0	12763-2	180	9.2 x 3.6



ULR12764 Halfround cut on hand

ULR	0	2	L mm	AxB mm
12764	12764-0	12764-2	180	9.2 x 3.6



ULR12771 Crossing

ULR	0	2	L mm	AxB mm
12771	-	12771-2	180	7.8 x 4.1



ULR12781 Round

ULR	0	2	L mm	A mm
12781	12781-0	12781-2	180	4.8



ULR12790 Pippin

ULR	0	2	L mm	A mm
12790	12790-0	12790-2	180	8.0 x 4.0

Rifflers 300 mm.

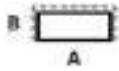

ULR12410 Hand

ULR	00	0	L mm	AxB mm
12410	12410-00	12410-0	300	12.8 x 4.0

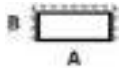

ULR12411 Hand

ULR	00	0	L mm	AxB mm
12411	12411-00	12411-0	300	12.8 x 4.0



ULR12430 Square

ULR	00	0	L mm	A mm
12430	12430-00	12430-0	300	7.5



ULR12440 Triangular

ULR	00	0	L mm	A mm
12440	12440-00	12440-0	300	10.5

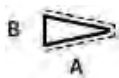

ULR12450 Knife

ULR	00	0	L mm	AxB mm
12450	-	12450-0	300	14.5 x 3.8



ULR12460 Halfround

ULR	00	0	L mm	AxB mm
12460	12460-00	12460-0	300	15.4 x 5.4



ULR12480 Round

ULR	00	0	L mm	A mm
12480	12480-00	12480-0	300	7.5

Assortments of rifflers 150 and 180 mm.

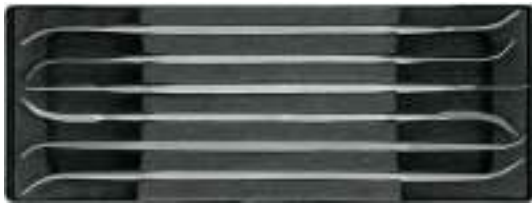

ASSORTMENT

ULR	0	2	L mm	Kg
12156	12156-0	12156-2	150	0.093

Assortment of 6 rifflers ULR2156 :

ULR12915, ULR12930, ULR12942, ULR12952, ULR12963 and ULR12981.



ASSORTMENT

ULR	0	2	L mm	Kg
12186	12186-0	12186-2	180	0.147

Assortment of 6 rifflers ULR2186 :

ULR12711, ULR12731, ULR12741, ULR12750, ULR12763 and ULR12781.

Precision rasps.



URA5190 Round



URA	2	L mm	A mm
5190-8	5190-8-2	200	8
5190-10	5190-10-2	250	10

Rasps (needle files).



ASSORTMENT (BLISTER)

URA	4	L mm	Kg
2526-140	2526-140-4	140	0.040

Assortment of 6 rasps (needle files) URA2526 :

URA2501, URA2502, URA2506, URA2507, URA2508 and URA2510.

HABILIS® rasps.

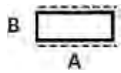

URA2701 Pillar

URA	3	L mm	AxB mm
2701	2701-3	205	10.0 x 3.1



URA2702 Halfround

URA	3	L mm	AxB mm
2702	2702-3	205	12.2 x 3.6



URA2707 Triangular

URA	3	L mm	A mm
2707	2707-3	205	10.3



URA2708 Square

URA	3	L mm	A mm
2708	2708-3	205	7



URA 2710 Round

URA	3	L mm	A mm
2710	2710-3	205	7



URA	3	L mm	Kg
2727	2727-3	205	0.261

Assortment of 6 HABILIS® rasps URA2727 :

URA2701, URA2702, URA2707, URA2708 and URA2710.

ASSORTMENT (BLISTER)

Frames for jeweller's saw blades.



UASB	Depth	Kg
400	75 mm	0.170

Frame for jeweller's saw blades.

Files handles.

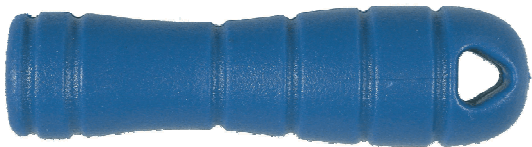

UAL	■	●	◐	▲	◀	▬	L mm	Kg
110-BLEU	-	4"	-	4"	-	-	94 mm	0.039
210-BLEU	4-5"	5-6"	-	5"	-	-	94 mm	0.041
310-BLEU	4-6"	-	4"	6"	4"	4"	94 mm	0.042
410-BLEU	8"	8"	6"	8"	6"	6"	105 mm	0.045
510-BLEU	8-10"	10-12"	8"	10"	8"	8"	105 mm	0.052
610-BLEU	10-12"	-	10"	10-12"	10"	10"	121 mm	0.082
710-BLEU	-	-	12"	-	12"	12"	130 mm	0.094

Antislip plastic handle with hardened threaded insert.



UAL	∅	L mm	Kg
160	2-3 mm	95 mm	0.028
260	3-4 mm	95 mm	0.028

Precision handle for needle files.

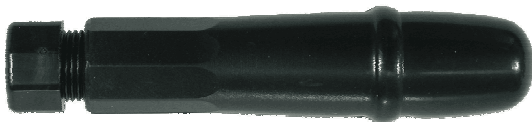

UAL	L mm	Kg
170	86 mm	0.015

Handle for needle files.



UAL	■	●	◐	▲	▬	L mm	Kg
200	-	-	4"	-	4"	80 mm	0.020
400	6"	6"	5"	6"	5"	100 mm	0.025
500	8"	8"	6"	8"	6"	115 mm	0.040
600	10"	10"	8-10"	10"	8-10"	125 mm	0.055

Wooden files handle.

Handles for ceramic fibre files.



UALF		For files	Kg
105	(1)	A = 0.5 mm	0.010
109		A = 0.9 mm	0.010
202	(2)	A = 2.34 mm	0.010
203	(3)	A = 3.0 mm	0.013
301	(4)	A = 1 mm	0.010
302		A = 2 mm	0.010
304		A = 4 mm	0.011

Handle for ceramic fibre files.

NUMERICAL INDEX

MSA00.	P.	MSA01.	P.	MSA02.	P.	MSA04.	P.
00.001-x	00-2	01.014	01-12	02.099	02-5	04.420-x	04-6
00.002-x	00-3	01.018-x	01-7	02.100-x	02-8	04.450-x	04-6
00.002-Lx	00-3	01.019-x	01-7	02.150...02.153	02-10	04.524-x	04-7
00.003-x	00-4	01.051	01-16	02.155	02-10	04.525-x	04-8
00.004-x	00-5	01.095	01-10	02.160...02.162	02-10	04.526-x	04-7
00.006-x	00-5	01.095-Z	01-10	02.170-x	02-9	04.540-x...04.542-x	04-8
00.007	00-5	01.099-x	01-9	02.220	02-12	04.550-x	04-8
00.008-x	00-4	01.100	01-8	02.221	02-12		
00.009-x	00-3	01.101-x	01-8	02.250-x	02-11		
00.010-x	00-5	01.101-V	01-9, 01-11			MSA05.	P.
00.012-x	00-8	01.102-x	01-9			05.001	05-13
00.013-x	00-8	01.103-x	01-9	MSA03.	P.	05.007...05.009	05-12
00.014	00-5	01.104	01-11	03.004	03-6	05.010...05.011-B	05-2
00.023-x	00-4	01.105-x	01-11	03.005	03-6	05.012...05.012-B	05-3
00.025-x	00-3	01.106-x	01-11	03.005-x	03-6	05.013 + 05.014	05-12
00.026-x	00-4	01.106-x	01-11	03.006	03-10	05.015-x	05-6
00.030-Lx	00-2, 00-7	01.107-x	01-13	03.010	03-10	05.017-03	05-5
00.031-x	00-2	01.108-x	01-13	03.010-x	03-10	05.017-x	05-4
00.032-x	00-2	01.202-Tx	01-6	03.011	03-11	05.019...05.019-B	05-3
00.099D-x	00-6	01.214	01-6	03.012	03-11	05.020	05-2
00.099G-x	00-6	01.214-x	01-6	03.014...03.018-x	03-11	05.021 + 05.022	05-4
00.100	00-7	01.215-050	01-3, 01-9	03.101-x	03-7	05.023	05-2
00.100D-x	00-6	01.215-x	01-3	03.102-x	03-7	05.031...05.031-x	05-3
00.100D-A1	00-7	01.216-050	01-4, 01-9	03.103-x	03-7	05.050...05.050-x	05-5
00.100G-x	00-6	01.216-x	01-4, 01-9	03.200	03-8	05.100...05.101-C	05-8
00.103D-x	00-7	01.218-x	01-3	03.300	03-18	05.107	05-13
00.103G-x	00-7	01.218-A	01-3	03.300-A	03-18	05.109 + 05.110	05-6
00.242	00-11	01.218-B	01-5	03.301	03-19	05.110-x	05-7
00.242-A	00-11	01.218-C	01-2	03.301-T	03-19	05.111	05-6
00.245	00-11	01.218-D	01-2	03.310	03-10	05.111-x	05-7
00.245-B	00-11	01.218-E	01-2	03.414	03-7	05.112	05-6
00.246	00-10	01.218-F	01-5	03.415	03-7	05.114	05-6
00.246-x	00-10	01.218-G	01-5	03.419	03-8	05.114-x	05-7
00.250-x	00-10	01.218-H	01-5	03.419-x	03-8	05.115...05.117	05-6
00.251-x	00-10	01.218-Tx	01-4	03.424	03-8	05.118...05.119-A	05-7
00.252	00-10	01.218-V	01-3	03.425-x	03-12	05.128 + 05.128-01	05-11
00.252	00-10	01.219-x	01-4	03.452	03-12	05.128-x	05-9, 05-10, 05-11
00.255-x	00-8	01.220-x	01-6	03.454	03-12	05.129	05-9
00.256-x	00-9	01.221-x	01-15	03.467...03.470	03-12	05.129-x	05-9, 05-10, 05-11
00.257-x	00-9	01.222-x	01-15	03.472...03.479	03-12	05.131...05.131-P	05-10
00.258	00-9	01.225	01-16	03.481	03-12		
00.259	00-9	01.300	01-8	03.483	03-13	MSA06.	P.
00.280	00-11	01.400-x	01-14	03.484	03-12	06.050...06.052	07-5
00.303	00-11	01.401	01-16	03.484	03-9	06.135 + 06.136	07-3
00.304	00-11	01.401-x	01-16	03.600-x	03-9	06.135 + 06.151	07-4
00.502	00-12	01.403-x	01-7	03.602	03-9	06.152	07-5
00.505	00-12	01.418	01-7	03.602-x	03-9	06.210...06.210-x	07-40
00.506	00-12	01.418-x	01-7	03.604	03-5	06.210...06.210-x	07-40
00.507	00-12	01.500	01-17	03.620-x	03-3, 03-4, 07-39	06.301-A...06.303-B	07-40
00.512	00-12	01.502-x	01-17	03.621...03.623	03-3	06.305 + 06.306	07-40
00.608-x	00-18	01.504	01-17	03.653-x	03-4	06.310...06.315	07-40
00.617-B	00-18	01.504-x	01-17	03.654-x...03.657	03-5	06.505...06.505-x	07-15
00.621	00-18			03.665-x	03-5	06.510...06.510-x	07-15
00.627	00-18			03.666	03-4	06.511-A + 06.511-B	07-14
00.646	00-19	MSA02.	P.	03.666-x	03-4	06.520-4750	07-11, 07-13
00.646-A	00-19	02.001-x	02-2	03.670...03.675	03-8	06.520-5x...06.520-6x	07-11
00.649	00-19	02.002-x	02-3	03.676-x	03-2	06.520-A	07-9
00.650	00-17	02.003-x	02-3	03.678-x...03.680-x	03-2	06.520...06.520-4641	07-9
00.652...00.654	00-17	02.004	02-5	03.806	03-14	06.521-4x	07-11, 07-13
00.655	00-18	02.005	02-3	03.806-x	03-15	06.521-5x...06.521-6x	07-11
00.656...00.656-x	00-15	02.006-x	02-6	03.838	03-17	06.521...06.521-3838	07-9
00.657	00-16	02.007	02-5	03.839-x	03-16	06.522...06.522-6x	07-10
00.659-x	00-13, 00-14	02.008-x	02-5	03.840-x	03-16	06.523	07-10
00.660-x	00-13	02.009	02-6	03.856-x	02-7, 03-16	06.524 + 06.525	07-11
00.663	00-16	02.009-R	02-6	03.856-x	13-12, 13-13	06.526...06.526-x	07-12
00.667	00-16	02.012	02-3	03.860 + 03.861	03-15	06.530...06.530-x	07-14
00.668	00-13	02.014-x	02-3	03.868...03.870	03-15		
00.670...00.673	00-16	02.015	02-2	03.880 + 03.881	03-15	MSA07.	P.
00.675	00-13	02.016...02.018	02-4	03.890-x...03.891-x	03-17	07.001	07-34
00.676	00-14	02.019	02-7	03.901...03.903	03-17	07.004...07.004-x	07-34
00.677	00-15	02.019-x	02-7	03.904...03.906	03-18	07.006-x	07-35
00.682	00-20, 28-19	02.020-x	02-4			07.007	07-34
00.683	00-20, 28-19	02.021	02-3	MSA04.	P.	07.009...07.009-x	07-36
00.684	00-20	02.022-x	02-6	04.001...04.004	04-2	07.010...07.012	07-39
00.685	00-17	02.023	02-7	04.006...04.008	04-2	07.013...07.014	07-29
00.686	00-17	02.025	02-4	04.010...04.012-B	04-2	07.016	07-34
		02.026	02-2	04.020	04-2	07.018...07.020	07-35
		02.027	02-2	04.061...04.065	04-4	07.022	07-33
		02.029	02-7	04.102...04.106	04-3, 18-4	07.024...07.025	07-35
MSA01.	P.	02.029-x	02-7	04.200 + 04.210	04-3	07.026...07.026-x	07-34
01.003	01-10	02.030	02-5	04.310-x	04-5	07.031	07-38
01.004	01-12	02.035...02.037	02-4	04.311-075	04-5	07.050	07-17
01.005	01-15	02.050	02-5	04.315-x...04.316-x	04-5	07.060...07.060-x	07-2
01.008	01-13	02.098	02-5	04.402-x	04-6	07.104	07-7, 07-8
01.013	01-10						

MSA07.	P.	MSA08.	P.	MSA10.	P.	MSA11.	P.
07.105...07.105-x	07-6	08.001...08.002-A	08-3	10.510	10-3	11.851	11-11, 11-12
07.106	07-12	08.010 + 08.010-A	08-4	10.510-A	10-4	11.851	11-27, 11-28
07.106-1x	07-7, 07-8, 07-12	08.104 + 08.104-A	08-4	10.511	10-4	11.852	11-11, 11-12
07.106-2x	07-7, 07-8, 07-12	08.502 + 08.503	08-5	10.513	08-5, 10-6	11.852	11-27, 11-28
07.106-3x	07-7, 07-8, 07-12			10.519	08-5, 10-6	11.853	11-11, 11-12
07.106-4245	07-7, 07-8, 07-12			10.520	10-7	11.853	11-27, 11-28
07.106-4648	07-7, 07-8, 07-13	MSA09.	P.	10.523	07-2	11.854 + 11.855	11-11, 11-12, 11-27
07.106-4950	07-7, 07-8, 07-13	09.002...09.005	09-10	10.524	07-18, 07-19, 07-20	11.856	11-12, 11-27
07.106-5255	07-7, 07-8, 07-13	09.006	09-6	10.527	10-4	11.857	11-12, 11-28
07.106-5760	07-13	09.010-00...09.010-19	09-2	10.528...10.529-x	10-5	11.859	11-17, 11-28
07.106-6265	07-13	09.010-20 +	09-5	10.531...10.531-A	10-7	11.900...11.905	11-21
		09.010-20-V					
07.106-U	07-7, 07-8, 07-9	09.010-21	09-6	10.532...10.532-x	10-8	11.906	11-20
07.106-U	07-10, 07-12	09.010-22...09.010-23	09-2	10.533	10-4	11.907	11-22
07.107...07.108	07-13	09.010-24...09.010-26	09-8			11.908	11-21
07.110...07.110-X	07-6	09.010-27 + 09.010-28	09-2	MSA11.	P.	11.909 + 11.910	11-20
07.111...07.111-x	07-16	09.010-29 + 09.010-30	09-5	11.105 + 11.106	11-5	11.911	11-22
07.112	07-15	09.010-31	09-8	11.198 + 11.198-A	11-24	11.920 + 11.921	11-18
07.113	07-16	09.010-32	09-2	11.199	11-13	11.924	11-19
07.114 + 07.114-A	07-36	09.010-33...09.010-35	09-5	11.200-A	11-13, 11-16	11.925	11-18
07.115-F	07-38	09.010-36	09-2	11.200-A	11-17, 11-28	11.928	11-18
07.115-G	07-37	09.010-37	09-8	11.200-B + 11.200-C	11-13	11.934	11-19
07.115...07.115-E	07-37	09.010-38	09-5	11.201-A	11-13, 11-16		
07.116	07-16	09.010-39	09-4	11.201-A	11-17, 11-28		
07.117...07.117-A	07-38	09.010-40 + 09.010-41	09-5	11.201-B + 13.201-C	11-13	MSA12.	P.
07.119 + 07.119-C	07-37	09.010-42	09-2	11.202-A	11-14, 11-16	12.150 + 12.151	12-12
07.119-C	07-37	09.010-43	09-6	11.202-A	11-17, 11-28	12.300-x	12-3, 12-4
07.130...07.130-C	07-7, 07-8	09.010-44	09-7	11.202-B + 11.202-C	11-14	12.300-x	12-17, 11-28
07.131	07-7	09.010-45 + 09.010-46	09-2	11.203-x	11-14	12.301-x	12-3, 12-4
07.132	07-8	09.010-47	09-3	11.205-C	11-15	12.301-x	12-5, 12-6
07.160-A	07-8	09.010-48	09-2	11.206-B + 11.207	11-15	12.301-x	12-7, 12-10
07.170 + 07.170-A	07-2	09.010-50	09-2	11.208-A + 11.209	11-16	12.301-x	12-11
07.208...07.210	07-33	09.010-52	09-3	11.210	11-15, 11-17, 11-28	12.302-x	12-3, 12-4
07.213...07.213-A	07-33	09.010-53	09-4	11.211	11-15	12.302-x	12-5, 12-6
07.305 + 07.305-A	07-30, 07-31	09.010-54	09-7	11.212	11-16, 11-17, 11-28	12.302-x	12-7, 12-10
07.307	07-30	09.010-55	09-3	11.213	11-16	12.302-x	12-11
07.308	07-31	09.010-58	09-4	11.215	11-13	12.303-x	12-4, 12-6, 12-7
07.311	07-19, 07-21	09.010-59	09-6	11.216	11-14	12.304-x	12-5, 12-6, 12-7
07.311	07-30, 07-31	09.010-60...09.010-61	09-2	11.226 + 11.226-A	11-24	12.305-x	12-3
07.312	07-30	09.010-62	09-4	11.228 + 11.229	11-23	12.306-x	12-6, 12-7
07.320 + 07.320-A	07-24	09.010-63	09-7	11.230 + 11.230-A	11-24	12.307-B5	12-6
07.320-A	07-24	09.010-64	09-4	11.300	11-24	12.312-x	12-8, 12-9, 12-11
07.322	07-28	09.010-67	09-2	11.705 + 11.706	11-23	12.380...12.390	12-2
07.323-A...07.323-D	07-19, 07-20, 07-21	09.010-68	09-6	11.800-A	11-2, 11-6, 11-8	12.398	12-18
07.323-A...07.323-D	07-24, 07-26	09.011...09.011-x	09-6	11.800-A	11-25, 11-27	12.649-x	12-19
07.323-E...07.323-F	07-19, 07-20, 07-26	09.012	09-4	11.800-B	11-2, 11-6	12.651-x	12-18
07.325	07-21, 07-26	09.015-x	09-9	11.800-B	11-7, 11-25	12.662	12-18
07.325-x	07-26	09.016-47	09-3	11.801-A	11-3, 11-6, 11-8	12.710...12.715-A	12-13
07.326-x	07-30	09.017 + 09.018	09-3	11.801-A	11-25, 11-27	12.721 + 12.721-A	12-13
07.327	07-19, 07-21	09.020-x	09-9	11.801-B	11-3, 11-6, 11-7	12.722...12.725-A	12-14
07.327	07-30, 07-31	09.021	09-9	11.801-B	11-25, 11-26	12.726...12.729	12-12
07.327-x	07-31	09.050-x	09-8	11.802-A	11-3, 11-6, 11-8	12.750 + 12.750-A	12-13
07.330-x	07-31	09.103 + 09.104	09-11	11.802-A	11-25, 11-27	12.811-x	12-14, 12-15, 12-16
07.331	07-32	09.300...09.303	09-12	11.802-B	11-3, 11-6	12.812-x	12-14, 12-15, 12-16
07.333	07-18, 07-19, 07-25	09.304	09-13	11.802-B	11-7, 11-25	12.813-x	12-16
07.333-x	07-25	09.305	03-12	11.803 + 11.804	11-6, 11-25	12.901-x	12-16, 12-17, 12-18
07.334...07.335-x	07-32	09.306	09-13	11.805	11-2	12.902-x	12-17, 12-18
07.336	07-19, 07-31			11.806	11-3	12.903-x	12-17, 12-18
07.337	07-31	MSA10.	P.	11.807	11-2	12.910	12-18
07.339	07-25	10.003...10.004-x	10-8	11.808-x	11-6		
07.343	07-25	10.005 + 10.005-A	10-7	11.809	11-2, 11-7, 11-26	MSA13.	P.
07.344	07-19, 07-20, 07-21	10.006	10-8	11.810	11-3, 11-8, 11-27	13.100 + 13.104-4	13-2
07.344	07-24, 07-26	10.007	10-7	11.812	11-5, 11-7	13.101 + 13.101-4	13-3
07.360	07-22, 08-2	10.008...10.008-x	10-8	11.812	11-25, 11-26	13.101-T	13-2, 13-3
07.360-A	07-21, 07-24, 07-27	10.009...10.009-x	10-9	11.813	11-7, 11-25	13.101-x	13-3
07.360-B	07-27, 08-2	10.010...10.010-x	10-6	11.816	11-5, 11-7, 11-26	13.102-x	13-2
07.360-H	07-23	10.301...10.301-x	10-11	11.817 + 11.818	11-7, 11-26	13.104...13.104+12	13-3
07.361	07-22	10.302...10.302-x	10-10	11.820	11-4, 11-8, 11-27	13.105	13-3
07.363	07-21	10.303 + 10.304	10-11	11.827	11-4, 11-7	13.110 + 13.113-4	13-4
07.364 + 07.365	07-22	10.304-x	10-11, PE-6	11.827	11-8, 11-26	13.120-x	13-5
07.367	07-20	10.306 + 10.307	10-9	11.828 + 11.829	11-4, 11-8, 11-26	13.121-x	13-6
07.367-A	07-18, 07-19, 07-28	10.309...10.309-x	10-10	11.830	11-5	13.121-400	13-12
07.367-P	07-18, 07-19, 07-20	10.311 + 11.311-08	10-9	11.831	11-8, 11-26	13.121-600	13-12
07.367-R	07-18, 07-19, 07-20	10.313	10-10	11.832	11-8, 11-27	13.121-700	13-6
07.368	07-18	10.499...10.500-x	10-2	11.833-B	11-9, 11-10, 11-27	13.121-800	13-6, 13-12
07.369	07-19	10.501	10-5	11.834-A	11-9	13.122-x	13-6
07.370	07-23	10.502-x	10-3	11.834-B	11-9, 11-10, 11-27	13.123...13.123-T4	13-7
07.371 + 07.372	07-19, 07-23	10.503-A	07-37, 10-3	11.835-A	11-9	13.124-3x	13-7
07.373-A + 07.373-B	07-14, 07-19	10.503-B + 10.503-C	10-3	11.835-B	11-9, 11-10, 11-27	13.124-4x	13-8
07.374	07-19, 07-20	10.503-x	10-3, 10-4	11.836	11-9	13.128-x	13-8
07.374	07-27, 08-2	10.504 + 10.505	10-2	11.837	11-10	13.129-x	13-12
07.374-A	07-27, 08-2	10.507	10-6	11.840	11-10, 11-27	13.150...13.155	13-14
07.375	07-21, 07-23	10.508...10.509-x	10-5	11.850	11-16, 11-28	13.210	13-9

MSA19.	P.	MSA19.	P.	MSA21.	P.	MSA22.	P.
19.501...19.502-x	19-30	19.820	19-36	21.355 + 21.356	21-14	22.564-x	22-4, 22-5
19.521-x	19-30	19.821	19-37	21.370	21-14	22.565	22-5
19.530-x	19-30	19.822	19-36	21.380	21-14	22.566-x	22-2
19.531	19-25	19.823...19.825-x	19-37	21.380-B	21-15	22.567-x	22-7
19.540-x	19-22, 19-25	19.826	19-36, 19-38	21.382-B	21-15	22.568	22-2, 22-7, 22-8
19.541	19-24	19.827-A...19.828-B	19-38	21.390	21-14	22.571-x	22-8
19.542	19-23	19.829...19.829-A	19-37	21.390-B	21-15	22.572-x	22-37
19.544	19-20	19.830-x	19-38	21.409	21-3	22.577-x...22.578-x	22-6
19.545	19-22	19.832 + 19.833	19-37	21.413...21.415	21-15	22.590-x	22-3
19.549 + 19.549-A	19-22	19.834...19.835-x	19-38	21.416...21.419	21-3	22.610-x	22-36
19.550	19-24	19.838	19-36	21.420...21.424	21-16	22.630-x	22-35
19.550-U	19-22, 19-24	19.839-A...19.842	19-38	21.427	21-16	22.640-x	22-36
19.551	19-22, 19-24	19.846-x...19.847	19-37	21.430	21-16	22.650-x	22-37
19.552	19-24	19.848	19-38	21.450	21-16	22.660-x	22-35
19.553	19-22, 19-24	19.850	19-34	21.452	21-16	22.670-x	22-36
19.554	19-24	19.851	19-38	21.460	21-16	22.700	22-28
19.555...19.562	19-24	19.856	19-37	21.480 + 21.481	21-17	22.701 + 22.702	22-20
19.563	19-20, 19-22, 19-24	19.859	19-36	21.483	21-17	22.703...22.705	22-21
19.564	19-24	19.867 + 19.868	19-37	21.484	21-5	22.706 + 22.707	22-24
19.565	19-22	19.873	19-38	21.485	21-17	22.708...22.710	22-21
19.567...19.571	19-23	19.875...19.875-x	19-34	21.490	21-5	22.711...22.713	22-22
19.572	19-20, 19-22	19.877...19.878	19-37	21.493	21-5	22.714	22-21
19.573...19.584	19-23	19.880...19.885	19-26	21.495	21-5	22.715 + 22.716	22-22
19.586 + 19.587	19-23	19.885-A + 19.885-B	19-27	21.500	21-5	22.717 + 22.718	22-23
19.589...19.597	19-23	19.886	19-26	21.507	21-5	22.719	22-33
19.599	19-23	19.901	19-44	21.510	21-5	22.720 + 22.721	22-23
19.611-x	19-31	19.908	19-44	21.514	21-5	22.722 + 22.723	22-19
19.612	19-27	19.910	19-43	21.599	21-8	22.724 + 22.725	22-33
19.614	19-28			21.600...21.604	21-6	22.726	22-32
19.617...19.619-x	19-31	MSA20.	P.	21.606 + 21.607	21-6	22.727	22-33
19.626	19-31	20.005	20-8	21.609...21.621	21-6	22.728 + 22.729	22-29
19.633-C	19-27	20.361	20-5	21.623 + 21.624	21-6	22.730	22-30
19.640-F	19-28	20.362	20-2	21.626...21.628	21-6	22.731	22-33
19.652	19-27	20.365	20-2	21.629...21.642	21-7	22.732	22-20
19.655	19-27	20.367	20-3	21.644...21.646	21-7	22.733	22-23
19.660-x	19-27	20.005-01	20-9	21.647...21.651	21-8	22.734	22-19
19.662-x	19-27	20.005-x	20-8	21.652...21.657	21-9	22.735	22-20
19.664-x	19-27	20.015-01	20-8	21.659...21.665	21-9	22.736	22-24
19.665-x	19-27	20.360-160	20-4	21.666	21-11	22.737 + 22.738	22-23
19.666-x	19-27	20.360-235	20-4	21.667...21.669	21-9	22.739	22-19
19.680 + 19.681	19-27	20.360-Cx	20-3, 20-6	21.670	21-8	22.740	22-27
19.682 + 19.683	19-28	20.360-F	20-5	21.671	21-9	22.741	22-24
19.686	19-28	20.360-P1 + 20.360-P2	20-3	21.700...21.704	21-10	22.742...22.745	22-25
19.705	19-18	20.360-P4	20-4	21.704-x	21-11	22.746...22.748	22-31
19.705-A	19-18, 19-19	20.361-Mx	20-5	21.705	21-10	22.749...22.751	22-32
19.705-P1	19-20	20.361-P1	20-5	21.705-x	21-11	22.752...22.754	22-30
19.706	19-18, 19-19	20.361-Px	20-6	21.706	21-10	22.755	22-31
19.708	19-18, 19-19	20.362-F	20-2	21.706-x	21-11	22.756	22-25
19.711	19-18	20.362-M1	20-3	21.750	21-8	22.757...22.759	22-26
19.712...19.713	19-29	20.368...20.368-x	20-4	21.800	21-9	22.760	22-27
19.715	19-18, 19-19	20.381...20.381-x	20-7	21.801 + 21.802	21-8	22.761	22-28
19.725...19.727	19-25					22.762	22-27
19.738 + 19.739	19-32	MSA21.	P.	MSA22.	P.	22.763 + 22.764	22-28
19.741...19.748	19-32	21.001...21.014	21-2	22.100-x	22-12	22.765 + 22.766	22-27
19.750	19-17	21.020...21.023	21-2	22.102-x...22.105-x	22-13	22.767...22.769	22-29
19.751	19-42	21.024	21-3	22.107-x	22-14	22.800...22.803	22-34
19.760-x	19-39	21.026...21.027-A	21-2	22.110-x	22-14	22.805 + 22.806	22-34
19.761	19-41	21.030...21.034	21-4	22.112-x...22.113-x	22-14	22.807	22-34
19.762...19.762-x	19-42	21.035...21.037	21-3	22.114-x...22.116-x	22-15		
19.765 + 19.765-A	19-42	21.040...21.043	21-4	22.117-x...22.119-x	22-16		
19.770	19-39	21.045...21.050	21-4	22.121-x	22-13	MSA23.	P.
19.770-Ax	19-40	21.051-x	21-2	22.122-x	22-16	23.000	23-6
19.770-Bx	19-40	21.052-x	21 - 16	22.123-x	22-15	23.000-x	23-8
19.770-Cx	19-40	21.061-21	21-2	22.211-x	22-12	23.001...23.003	23-6
19.770-KIT	19-39	21.070 + 21.071	21 - 15	22.300-x...22.303-x	22-10	23.004	23-6
19.770-Mx	19-40	21.073...21.075	21 - 15	22.304-x...22.306-x	22-11	23.005	23-5
19.772	19-39	21.077 + 21.078	21 - 15	22.308-x...22.309-x	22-12	23.500	23-4
19.773-x...19.775-x	19-39	21.080	21 - 15	22.311-x	22-12	23.500-09	23-4
19.790...19.794	19-21	21.090	21 - 16	22.312-x...22.313-x	22-11	23.500-A	23-3, 23-4
19.795	19-20	21.100 + 22.100-A	21-3	22.400-x...22.401-x	22-9	23.500-V	23-4
19.807...19.808	19-35	21.200 + 21.201	21-12	22.404-x...22.405-x	22-9	23.501	23-2
19.808-P	19-36	21.210...21.213	21-12	22.407-x...22.408-x	22-9	23.501-G	23-3, 23-4
19.811	19-35, 19-36, 19-37	21.215 + 21.216	21-12	22.412-x	22-37	23.501-P	23-3
19.811-F	19-38	21.251 + 21.252	21-12	22.450-x	22-10	23.501-x	23-3
19.812	19-35, 19-36, 19-38	21.260	21-12	22.500	22-17	23.502	23-2
19.813	19-35, 19-36, 19-37	21.310	21-14	22.510	22-17	23.503	23-4
19.813-A	19-37	21.319	21-15	22.515	22-18	23.503-A	23-3, 23-4
19.814 + 19.814-A	19-37	21.320	21-14	22.520	22-18	23.504	23-2
19.815	19-38	21.322	21-14	22.529	22-4	23.504-G	23-3, 23-4
19.816	19-35, 19-36, 19-38	21.330 + 21.331	21-14	22.560-x	22-3	23.504-x	23-3
19.817	19-36, 19-37	21.340...21.343	21-14	22.562-x	22-4, 22-5	23.505	23-2
19.819	19-37	21.350 + 21.351	21-14	22.563-x	22-5	23.600...23.601	23-7
						23.800...23.801	23-9

MSA28.	P.	MSA42.	P.	PERF	P.	VALLORBE	P.
28.9704-005	28-35	42.340	42-5	384-x	PE-8	ULAV2407-x	VA-30
28.9705-005	28-35	42.341	42-6	385	PE-8	ULAV2410-x	VA-30
28.9706-005	28-35	42.342	42-7	390	PE-4	ULAV2411-x	VA-30
28.C7-x	28-9	42.343	42-7	437-x	PE-12	ULAV2465	VA-30
28.D2-x	28-9	42.344	42-9	441-x	PE-12	ULAV2495	VA-30
28.D3-x	28-9			445	PE-12	ULE3000-A	VA-17
28.D4-x	28-9	MSA98.	P.	458...459B	PE-6	ULE3004-x	VA-15
28.D5-x	28-9	98.015	98-2	460x	PE-10	ULE3008-x	VA-15
28.H10-x	28-9			480	PE-9	ULE3009-x	VA-15
28.I31-x	28-10	PERF	P.	485	PE-10	ULE3010-x	VA-15
28.I4-x	28-10	007	PE-4	490	PE-13	ULE3011-x	VA-15
28.J.0100	28-24	012	PE-13	595	PE-3	ULE3012-x	VA-15
28.K6-x	28-17	015	PE-4	690	PE-16	ULE3014-x	VA-15
28.K7-1L	28-17	018	PE-13	810	PE-13	ULE3015-x	VA-16
28.L5-x	28-18	020	PE-3	810-A	PE-13	ULE3016-x	VA-16
28.MEC2017	28-18	021	PE-15			ULE3017-x	VA-16
28.QUA2017	28-18	022	PE-4	PILE	P.	ULE3020-x	VA-16
28.SL007	28-29, 28-30	023	PE-4	L92	00 - 10, 00 - 11, 00 - 20	ULE3021-x	VA-16
28.TH7-002	28-10	024	PE-15			ULE3026-x	VA-16
28.UT18-x	28-25	025	PE-15	VALLORBE	P.	ULE3029-x	VA-16
28.V105-x	28-19	026	PE-13	UAL110-BLEU	18-2, VA-42	ULF3080	VA-17
28.V106-x	28-19	027	PE-13	UAL160	18-2, VA-42	ULE3092	VA-17
		028	PE-4	UAL170	18-2, VA-42	ULEC3008-55	VA-19
MSA29.	P.	030	PE-15	UAL200	18-3, VA-42	ULEC3009-55	VA-19
29.227	29-2	031	PE-5	UAL210-BLEU	18-2, VA-42	ULEC3010-55	VA-19
29.501	29-3	032	PE-5	UAL260	18-2, VA-42	ULEC3014-55	VA-20
29.606	29-3	034	PE-3	UAL310-BLEU	18-2, VA-42	ULEC3017-55	VA-20
29.610-A	29-4	035	PE-5	UAL400	18-3, VA-42	ULEC3020-55	VA-20
29.611-A14	29-4	045	PE-4	UAL410-BLEU	18-2, VA-42	ULEC3021-55	VA-20
29.611-A18	29-4	046	PE-4	UAL500	18-3, VA-42	ULEC3062	VA-20
29.614-B	29-3	080	PE-15	UAL510-BLEU	18-2, VA-42	ULF0502-x	VA-23
29.615	29-2	095	PE-15	UAL600	18-3, VA-42	ULF0504-x	VA-23
29.616	29-2	096	PE-15	UAL610-BLEU	18-2, VA-42	ULF0505-x	VA-24
29.626	29-2	106	17-25, PE-13	UAL710-BLEU	18-2, VA-42	ULF0909-x	VA-24
29.631	29-2	111-x	PE-2	UALF105	18-3, VA-42	ULF1001-x	VA-24
29.651	29-3	115-x	PE-2	UALF109	18-3, VA-42	ULF1002-x	VA-23
29.651-A	29-3, PE-16	116-x	PE-2	UALF202	18-3, VA-42	ULF1004-x	VA-23
29.700	29-5	121-x	PE-2	UALF203	18-3, VA-42	ULF234-x	VA-23
29.700-x	29-5	131-x	PE-2	UALF301	18-3, VA-42	ULF30-x	VA-23
		132	PE-2	UALF302	18-3, VA-42	ULH2601-x	VA-28
MSA32.	P.	133	PE-2	UALF304	18-3, VA-42	ULH2602-x	VA-28
32.001-901	32-2	161...163A	PE-14	UASB400	VA-42	ULH2607-x	VA-28
32.001-902	32-2	167...169	PE-7	UDA8401-x	VA-21	ULH2608-x	VA-28
32.001-x	32-2	170	PE-9	UDA8402-x	VA-21	ULH2610-x	VA-28
32.003-A	32-3	170-A	PE-9	UDA8407-x	VA-21	ULH2627	VA-28
32.003-B	32-3	176	PE-7	UDA8408-x	VA-21	ULH2630	VA-29
32.003-x	32-3	176-A	PE-7	UDA8410-x	VA-21	ULH2901-x	VA-28
32.020	32-4	177...178	PE-9	UDA8411-x	VA-21	ULO0401-x	VA-25
32.021	32-4	193	PE-15	UDA8432	VA-21	ULO0402-x	VA-25
32.030	32-4	194	PE-10	UDA9401	VA-22	ULO0403-x	VA-25
32.100	32-4	195	PE-15	UDA9402	VA-22	ULO0404-x	VA-26
32.101-x	32-4	196	PE-16	UDA9407	VA-22	ULO0405-x	VA-26
		202	PE-10	UDA9408	VA-22	ULO0406-x	VA-26
MSA38.	P.	214	PE-10	UDA9410	VA-22	ULO0501-x	VA-26
38.000	38-2	229...231	PE-6	UDA9470	VA-22	ULO0502-x	VA-26
38.002...38.006	38-2	250	PE-11	UDD8800-x	VA-22	ULO0653-x	VA-27
38.010	38-3	260	PE-11	ULA2400-A	VA-14	ULO0655-x	VA-27
38.010-N	38-3	261...264	PE-11	ULA2401-x	VA-11	ULO0788-x	VA-27
38.013	38-3	266	PE-13	ULA2402-x	VA-11	ULP1040-x	VA-8
38.014	38-3	270	PE-11	ULA2403-x	VA-11	ULP1060-x	VA-9
38.016-N	38-3	303	PE-10	ULA2405-x	VA-11	ULP1061-x	VA-9
38.110...38.112	38-5	313	PE-5	ULA2406-x	VA-11	ULP1095	VA-10
38.125	38-4	314	PE-5	ULA2407-x	VA-12	ULP1132-x	VA-3
38.128	38-4	317	PE-13	ULA2408-x	VA-12	ULP1133-x	VA-3
38.129	38-4	318	PE-3	ULA2409-x	VA-12	ULP1136-x	VA-4
		322	PE-3	ULA2410-x	VA-12	ULP1138-x	VA-4
MSA42.	P.	328	PE-3	ULA2411-x	VA-12	ULP1142-x	VA-4
42.102	42-11	329	PE-3	ULA2414-x	VA-13	ULP1152-x	VA-4
42.103	42-11	330	PE-4	ULA2415-x	VA-13	ULP1163-x	VA-3
42.110	42-11	331	PE-10	ULA2416-x	VA-13	ULP1166-x	VA-3
42.137	42-8	332	PE-3	ULA2417-x	VA-13	ULP1168	VA-3
42.141	42-8	355...360B	PE-12	ULA2418-x	VA-13	ULP1170-x	VA-4
42.160	42-10	364	PE-12	ULA2420-x	VA-13	ULP1180-x	VA-4
42.174	42-5	366	PE-12	ULA2423-x	VA-13	ULP1185-x	VA-5
42.184	42-3	370	PE-16	ULAC2401-140	VA-18	ULP1230-x	VA-5
42.185	42-9	370-A	PE-16	ULAC2402-140	VA-18	ULP1263-x	VA-5
42.186	42-10	372	PE-16	ULAC2403-140	VA-18	ULP1265-X	VA-5
42.187	42-4	375	PE-8	ULAC2407-140	VA-18	ULP1268-x	VA-5
42.188	42-4	376	PE-8	ULAC2408-140	VA-18	ULP1292-x	VA-10
42.189	42-3	379...381	PE-8	ULAC2410-140	VA-19	ULP1312-x	VA-5
42.316	42-11	383	PE-8	ULAC2411-140	VA-19	ULP1352-x	VA-6
42.332	42-6	383x	PE-9	ULAC2462	VA-19	ULP1360-x	VA-7

