

06/07



UNIVERSAL PRESSES FOR SCREW-ON / SNAP-ON DIES

07 - 2

ASSORTMENTS OF SCREW-ON DIES

07 - 9

ASSORTMENTS OF SNAP-ON DIES

07 - 15

PRESSES FOR SCREW / UNSCREW CASE BACKS

07 - 17

TOOLS FOR SCREW / UNSCREW CASE BACKS

07 - 29

TOOLS FOR SNAP-ON CASE BACKS

07 - 34

OTHER TOOLS

07 - 39

Rack-press.



MSA	Size	Kg
07.060	200 x 200 x 380 mm	8.140

The strongest rack-press in its class, ideally suited for all work requiring high force or for production work, series (adjustable stop ensuring repeatability of the press in).

Its extreme robustness as well as its long travel make it a perfect versatile press. Its one-piece design guarantees an optimal alignment.

- Reaming table/broach : Ø 10 mm
- Travel 110 mm.

*Delivered with 2 adaptors (lower and upper) compatible with all Horotec® screw-on dies (thread Ø 6 mm).
See pages 07-9...07-14.*

Spare parts :

MSA	Item	Kg
07.060-A	Adjustment screw	0.010
07.060-B	Ring on adjustment screw	0.003
07.060-C	Maintaining screw of the broach die support	0.012
07.060-D	Tightening knob of the lower die support	0.020
07.170-A	Lower and upper adaptor for screw-on dies	0.011

Accessory :

MSA	Item	Kg
10.523	Pin punch support, Ø 10 x L 40 mm	0.019



MSA	Size	Kg
07.170	160 x 150 x 220 mm	7.000

Rack-press for right or left handed users (the lever is removable and can be placed on the right or on the left according to the user).

For heavy-duty jobs in production or after sales service.

The broach is pierced and equipped with an air connector Ø 6 mm on the top to eventually handle the components by vacuum.

- Travel 110 mm.

*Delivered with 2 adaptors (lower and upper) compatible with all Horotec® screw-on dies (thread Ø 6 mm).
See pages 07-9...07-14.*

Spare part :

MSA	Item	Kg
07.170-A	Lower and upper adaptor for screw-on dies	0.011

Accessory :

MSA	Item	Kg
10.523	Pin punch support, Ø 10 x L 40 mm	0.019



Left-handed version.

Right-handed version.



MSA	Broach	Size	Kg
06.135	Simple	80 x 225 x 180 mm	1.980

Stable precision press, equipped with a head and a massive aluminium base mounted on 2 robust steel columns. The frontal part V shaped, allows the glass fitting without removing the bracelets. The steel axle slides freely in a self-lubricated sleeve for maximum precision: this is essential for fitting back cases, glasses or bezels without scratching. The end of the threaded axle (Ø 6 mm) is specially made for screwing all dies in a perfect horizontal position. Changing dies becomes easier. The lever covered with an anti-skid rubber and equipped with a return spring, which allows a fine control of fitting pressure.

Compatible with all Horotec® screw-on dies (thread Ø 6 mm).
See pages 07-9...07-14.

FOR SCREW-ON DIES



MSA	Broach	Kg
06.136	Simple	2.800

Precision press MSA06.135 (see above), delivered with 4 assortments of Delrin® screw-on dies MSA06.520, MSA06.521, MSA06.522 and MSA07.106 (43 pieces).

Compatible with all Horotec® screw-on dies (thread Ø 6 mm).
See pages 07-9...07-14.

FOR SCREW-ON DIES





FOR SCREW-ON DIES

MSA	Broach	Size	Kg
06.150	Double	80 x 215 x 185 mm	2.685

This precision rack-press is provided with a small slide that allows to block or to free the toothed rack. The watchmaker thus has an exceptional tool for fitting glasses and bezels, closing watch cases and maintain the glass on the watch case during joining time. After screwing the die on the die holder, one can determine the best way to proceed :

- free toothed rack (slide ahead) :
For usual work on steel watch cases, thick or sturdy ; apply pressure on the lever provided with an anti-skid rubber. The return spring and the fixed handle allow for careful adjustment of pressure upon use.

- blocked toothed rack (slide behind) :
For delicate work on gold cases, thin or delicate; pull the slide to lock the toothed rack in the desired position, then use the spanner, to fit the glass or the case back; with each rotation the die goes down about 1.5 mm. The fitting precision can be perfectly controlled.

*Compatible with all Horotec® screw-on dies (thread Ø 6 mm).
See pages 07-9...07-14.*



FOR SCREW-ON DIES

MSA	Broach	Kg
06.151	Double	3.120

Precision rack-press MSA06.150 (see above), delivered with 4 assortments of Delrin® screw-on dies MSA06.520, MSA06.521, MSA06.522 and MSA07.106 (43 pieces).

*Compatible with all Horotec® screw-on dies (thread Ø 6 mm).
See pages 07-9...07-14.*





MSA	Broach	Kg
06.152	Double	6.640

Precision rack-press MSA06.150 (see previous page), delivered in a wooden box. (1)
 - 4 assortments of Delrin® screw-on dies (43 pieces) : MSA06.520, MSA06.521, MSA06.522 and MSA07.106. Delivered in a wooden box. (2)
 Compatible with all Horotec® screw-on dies (thread Ø 6 mm).
 See pages 07-9...07-14.

FOR SCREW-ON DIES

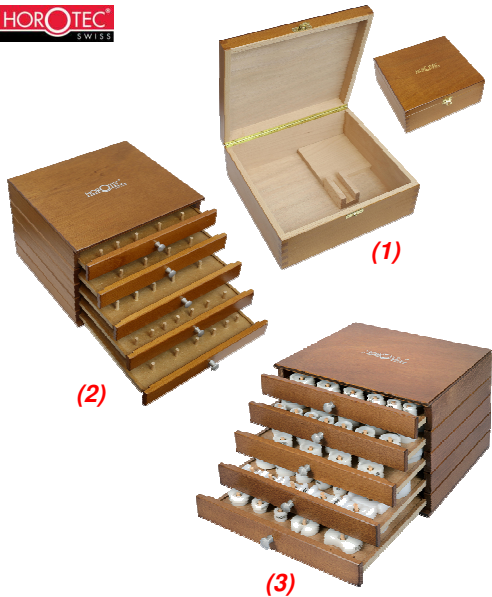

Items of the wooden box MSA06.052 (delivered without dies) :

MSA	Item	Kg
06.050	(1) Empty wooden box for press, 240x220x90 mm	0.860
06.052	(2) Empty wooden box for dies, 240x220x160 mm	2.220
06.051	(3) Wooden box with 80 dies, 240x220x160 mm	3.540
-	-	-
06.051-01	(4) Lower base	0.235
06.051-02	(5) Upper base	0.297
06.051-03	(6) Spacer	0.124
06.051-04	(7) Tray for dies assortments MSA07.106 and MSA07.108	0.264
06.051-05	(8) Tray for dies assortments MSA06.521 and MSA06.525	0.264
06.051-06	(9) Tray for dies assortments MSA06.522 and MSA06.523	0.260
06.051-07	(10) Tray for dies assortments MSA06.520 and MSA06.524	0.263
06.051-08	(11) Tray for dies assortments MSA06.526 and MSA06.530	0.262

Details of the dies assortments, see pages 07-9...07-14.

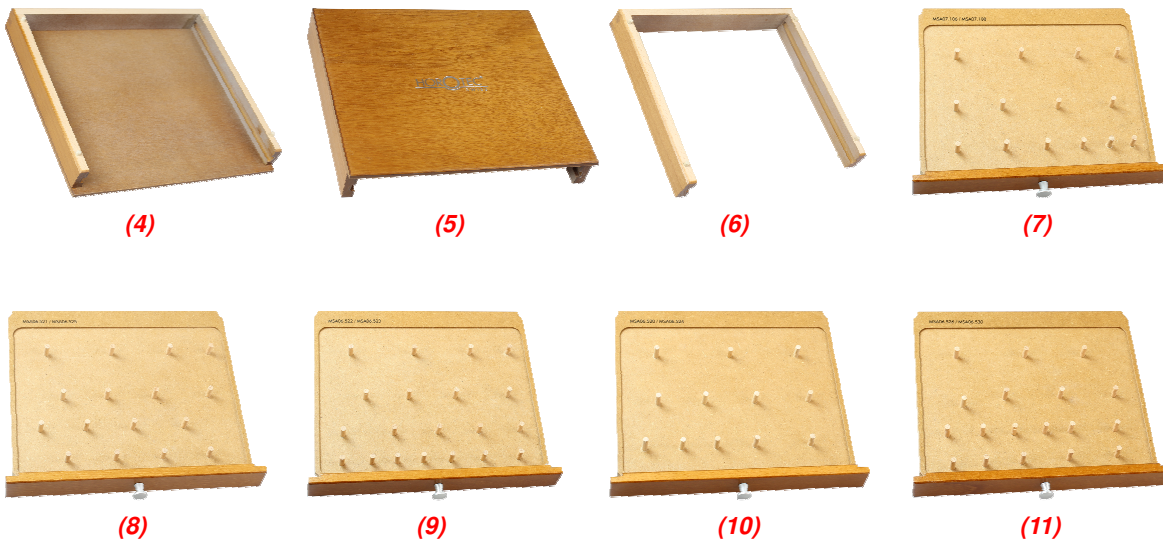

HOROTEC® press provided with SNAP-ON dies.



FOR SNAP-ON DIES

MSA	Broach	Size	Kg
07.110	Simple	80 x 60 x 130 mm	0.580

Small press for closing snap-on case backs, equipped with a simple threaded broach.
Compatible with all Horotec® snap-on reversible dies (see pages 07-15...07-16).

Delivered with an assortment of 6 Delrin® snap-on dies MSA07.111.

Spare parts :

MSA	Item	Kg
07.110-A	(1) Upper die support	0.002
07.110-B	(2) Upper plate	0.062
07.110-J	(3) O'Ring gasket for upper die support	0.001
07.110-P	(4) Broach with handle	0.040

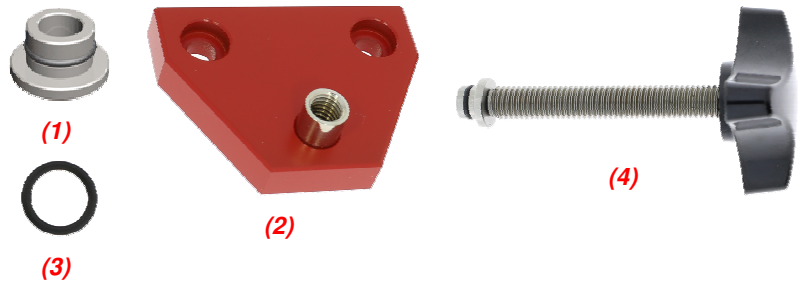

HOROTEC® press provided with SCREW-ON dies.

Advantage : a wide variety of dies is available with a standard thread of 6 mm.



FOR SCREW-ON DIES

MSA	Broach	Size	Kg
07.105	Simple	80 x 60 x 135 mm	0.630

Small press for closing snap-on case backs, equipped with a simple threaded broach.
Compatible with all Horotec® screw-on dies (thread Ø 6 mm). See pages 07-9...07-14.

Delivered with an assortment of 9 Delrin® screw-on dies MSA07.106.

Spare parts :

MSA	Item	Kg
07.105-A	(1) Upper dies holder	0.008
07.105-P	(2) Broach with handle	0.034
07.105-V	(3) Fixing screw for upper dies holder	0.001

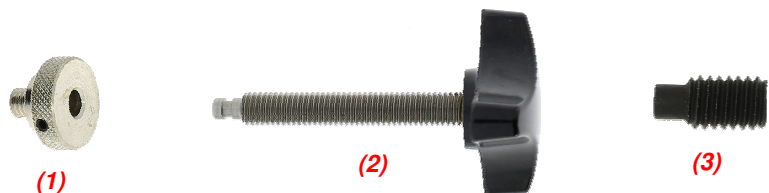

HOROTEC® presses for both SCREW-ON and SNAP-ON dies.

Advantage : a wide variety of screw-on dies is available with a standard thread of 6 mm and snap-on dies Ø 8 mm (upper dies) and Ø 5 mm (lower dies). See pages 07-9...07-16.



For screw-on dies

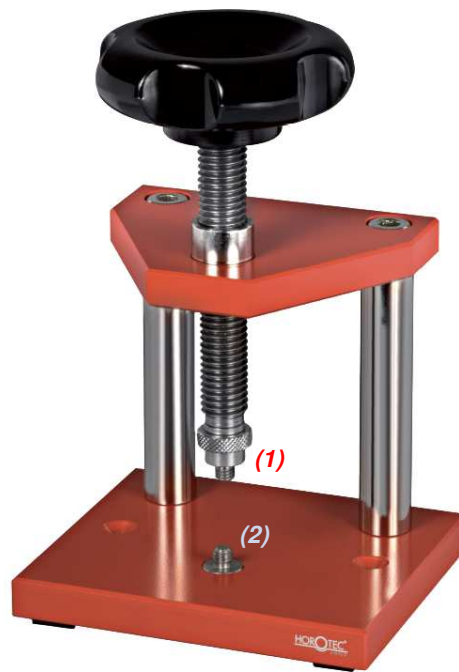

FOR SCREW-ON AND SNAP-ON DIES

MSA	Size	Kg
07.131	110 x 95 x 210 mm	1.575

Small sized press, suitable for screw-on and snap-on dies, even large diameters. Compatible with all Horotec® dies. See pages 07-9...07-16.

Delivered with an assortment of 12 Delrin® screw-on dies for fitting snap-on case backs.

Press MSA07.131 contents :

MSA	Item	Kg
07.104	assortment of 12 screw-on dies	0.180
07.130	Press	1.000
07.130-A	(1) Upper adaptor for screw-on dies	0.012
07.130-B	(2) Reversible lower adaptor for screw-on and snap-on dies	0.008
07.130-C	(4) Broach with wheel	0.185

Assortment MSA07.104 contents :

MSA	Item	Kg
07.106-17	Screw-on die, Ø 17 mm	0.004
07.106-1921	Screw-on die, Ø 19-21 mm	0.005
07.106-2225	Screw-on die, Ø 22-25 mm	0.006
07.106-2629	Screw-on die, Ø 26-29 mm	0.008
07.106-3033	Screw-on die, Ø 30-33 mm	0.010
07.106-3437	Screw-on die, Ø 34-37 mm	0.012
07.106-3841	Screw-on die, Ø 38-41 mm	0.015
07.106-4245	Screw-on die, Ø 42-45 mm	0.017
07.106-4648	Screw-on die, Ø 46-48 mm	0.020
07.106-4950	Screw-on die, Ø 49-50 mm	0.022
07.106-5255	Screw-on die, Ø 52-55 mm	0.025
07.106-U	Universal screw-on inferior die, Ø 45 mm	0.014

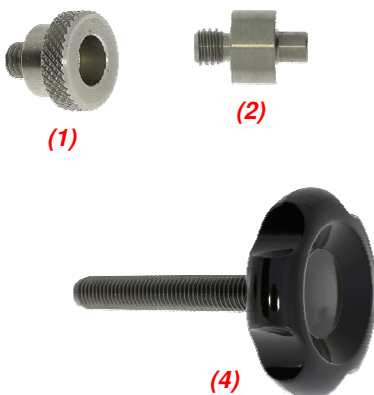



For screw-on dies

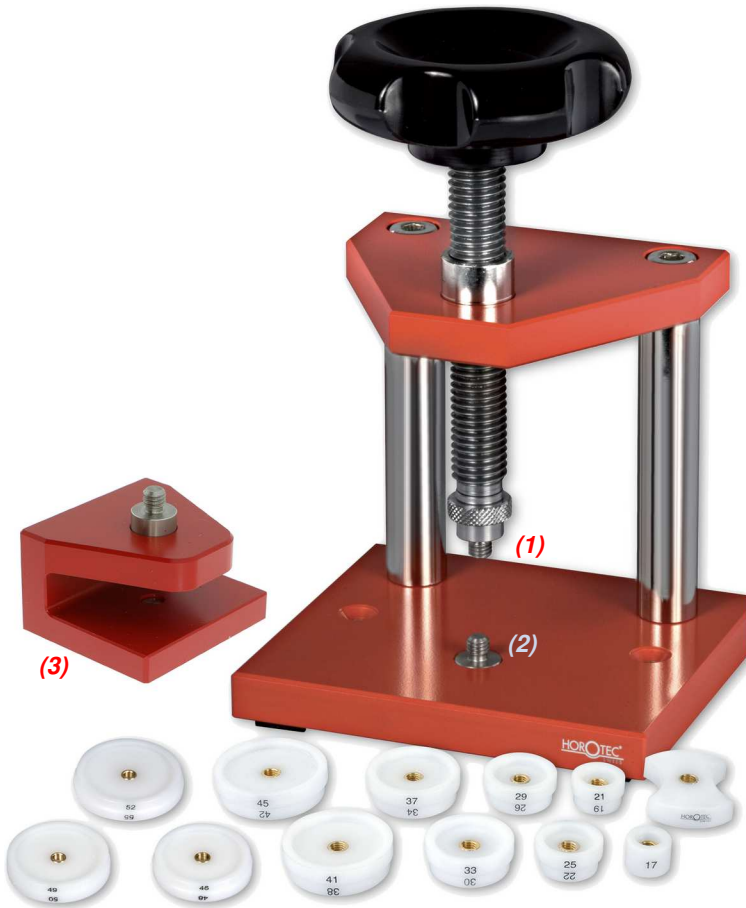

FOR SCREW-ON AND SNAP-ON DIES

MSA	Size	Kg
07.132	110 x 95 x 210 mm	1.460

Small sized press, suitable for screw-on and snap-on dies, even large diameters. Compatible with all Horotec® dies. See pages 07-9...07-16.

Delivered with an assortment of 12 Delrin® screw-on dies for fitting snap-on case backs and 1 support for closed bracelet MSA07.160-A.

Press MSA07.132 contents :

MSA	Item	Kg
07.104	assortment of 12 screw-on dies	0.180
07.130	Press	1.000
07.130-A	(1) Upper adaptor for screw-on dies	0.012
07.130-B	(2) Reversible lower adaptor for screw-on and snap-on dies	0.008
07.130-C	(4) Broach with wheel	0.185
07.160-A	(3) Support for closed band	0.125

Assortment contents MSA07.104 :

MSA	Item	Kg
07.106-17	Screw-on die, Ø 17 mm	0.004
07.106-1921	Screw-on die, Ø 19-21 mm	0.005
07.106-2225	Screw-on die, Ø 22-25 mm	0.006
07.106-2629	Screw-on die, Ø 26-29 mm	0.008
07.106-3033	Screw-on die, Ø 30-33 mm	0.010
07.106-3437	Screw-on die, Ø 34-37 mm	0.012
07.106-3841	Screw-on die, Ø 38-41 mm	0.015
07.106-4245	Screw-on die, Ø 42-45 mm	0.017
07.106-4648	Screw-on die, Ø 46-48 mm	0.020
07.106-4950	Screw-on die, Ø 49-50 mm	0.022
07.106-5255	Screw-on die, Ø 52-55 mm	0.025
07.106-U	Universal screw-on inferior die, Ø 45 mm	0.014

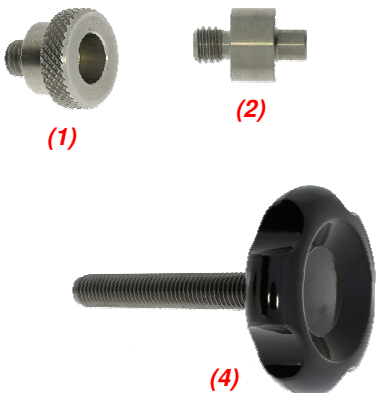

- We recommend using only HOROTEC® original screw-on dies with our presses :
- They are made of Delrin (non-marring nylon)
 - They are provided with a reinforced metal core, for extreme pressures
 - There are many different models to cover all your needs
 - They are adaptable on all presses on the market with a threaded axle Ø 6 mm.

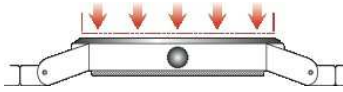

MSA	Packaging size	Kg
06.520	245 x 100 mm	0.144

Assortment of 8 Delrin® screw-on reversible dies FOR FITTING FLAT MINERAL CRYSTALS.

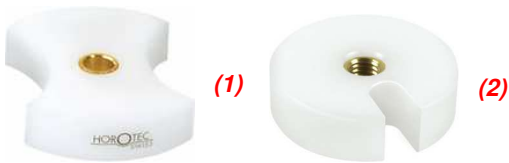

Universal inferior die

Die for crystals with loupe



Flat die

Assortment contents (brass centre thread Ø 6 mm) :

MSA	Item	Kg
06.520-16	Screw-on die, Ø 16 mm	0.004
06.520-2217	Screw-on die, Ø 17-22 mm	0.005
06.520-2823	Screw-on die, Ø 23-28 mm	0.008
06.520-3429	Screw-on die, Ø 29-34 mm	0.013
06.520-4035	Screw-on die, Ø 35-40 mm	0.019
06.520-4641	(3) Screw-on die, Ø 41-46 mm	0.025
06.520-A	(2) Screw-on die for crystals with loupe, Ø 35 mm	0.012
07.106-U	(1) Universal screw-on inferior die, Ø 45 mm	0.014

ASSORTMENT : SCREW-ON DIES

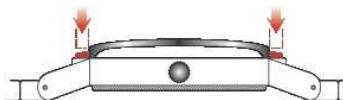

MSA	Packaging size	Kg
06.521	245 x 100 mm	0.164

Assortment of 11 Delrin® screw-on reversible dies FOR FITTING WATCH CRYSTALS.

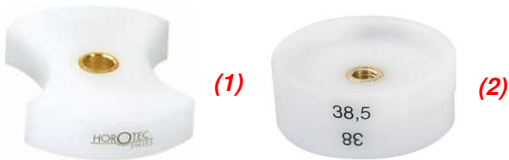

Universal inferior die

Hollow die with thin straight edge. Depth 4.50 mm

Assortment contents (brass centre thread Ø 6 mm) :

MSA	Item	Kg
06.521-2526	Screw-on die, Ø 25-26 mm	0.007
06.521-2728	Screw-on die, Ø 27-28 mm	0.008
06.521-2930	Screw-on die, Ø 29-30 mm	0.009
06.521-3132	Screw-on die, Ø 31-32 mm	0.010
06.521-3333	Screw-on die, Ø 33-33.50 mm	0.011
06.521-3434	Screw-on die, Ø 34-34.50 mm	0.011
06.521-3535	Screw-on die, Ø 35-35.50 mm	0.012
06.521-3636	Screw-on die, Ø 36-36.50 mm	0.013
06.521-3737	Screw-on die, Ø 37-37.50 mm	0.013
06.521-3838	(2) Screw-on die, Ø 38-38.50 mm	0.014
07.106-U	(1) Universal screw-on inferior die, Ø 45 mm	0.014

ASSORTMENT : SCREW-ON DIES

ASSORTMENTS OF SCREW-ON DIES



Universal inferior die



Hollow die with oblique edge

ASSORTMENT SCREW-ON DIES

MSA	Packaging size	Kg
06.522	245 x 100 mm	0.163

Assortment of 15 Delrin® screw-on reversible dies FOR FITTING CRYSTALS WITH TENSION RING.

Assortment contents (brass centre thread Ø 6 mm) :

MSA	Item	Kg
06.522-15	Screw-on die, Ø 15 mm	0.003
06.522-1617	Screw-on die, Ø 16-17 mm	0.003
06.522-1819	Screw-on die, Ø 18-19 mm	0.004
06.522-2021	Screw-on die, Ø 20-21 mm	0.005
06.522-2223	Screw-on die, Ø 22-23 mm	0.005
06.522-2425	Screw-on die, Ø 24-25 mm	0.006
06.522-2627	Screw-on die, Ø 26-27 mm	0.007
06.522-2829	Screw-on die, Ø 28-29 mm	0.008
06.522-3031	Screw-on die, Ø 30-31 mm	0.009
06.522-3233	Screw-on die, Ø 32-33 mm	0.009
06.522-3435	Screw-on die, Ø 34-35 mm	0.010
06.522-3637	Screw-on die, Ø 36-37 mm	0.012
06.522-3839	Screw-on die, Ø 38-39 mm	0.013
06.522-4041	(2) Screw-on die, Ø 40-41 mm	0.014
07.106-U	(1) Universal screw-on inferior die, Ø 45 mm	0.014



Curved die with thin edge

ASSORTMENT SCREW-ON DIES SPECIAL LARGE DIAMETER

MSA	Packaging size	Kg
06.523	245 x 100 mm	0.156

Assortment of 5 Delrin® screw-on reversible dies FOR FITTING LARGE TENSION RING GLASSES.

Assortment contents (brass centre thread Ø 6 mm) :

MSA	Item	Kg
06.522-4245	Screw-on die, Ø 42-45 mm	0.015
06.522-4750	Screw-on die, Ø 47-50 mm	0.020
06.522-5255	Screw-on die, Ø 52-55 mm	0.023
06.522-5760	Screw-on die, Ø 57-60 mm	0.027
06.522-6265	(1) Screw-on die, Ø 62-65 mm	0.032

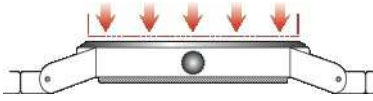

Flat die

MSA	Packaging size	Kg
06.524	245 x 100 mm	0.208

Assortment of 4 Delrin® screw-on reversible dies FOR FITTING LARGE FLAT MINERAL GLASSES.

Assortment contents (brass centre thread Ø 6 mm) :

MSA	Item	Kg
06.520-4750	Screw-on die, Ø 47-50 mm	0.031
06.520-5255	Screw-on die, Ø 52-55 mm	0.039
06.520-5760	Screw-on die, Ø 57-60 mm	0.046
06.520-6265	(1) Screw-on die, Ø 62-65 mm	0.054

**ASSORTMENT
SCREW-ON DIES SPECIAL LARGE DIAMETER**

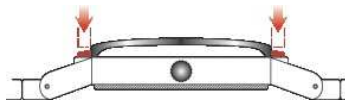

Reversible die

MSA	Packaging size	Kg
06.525	245 x 100 mm	0.163

Assortment of 5 Delrin® screw-on reversible dies FOR FITTING LARGE CASE BEZELS.

Assortment contents (brass centre thread Ø 6 mm) :

MSA	Item	Kg
06.521-4045	Screw-on die, Ø 40-45 mm	0.016
06.521-4650	Screw-on die, Ø 46-50 mm	0.020
06.521-5255	Screw-on die, Ø 52-55 mm	0.025
06.521-5760	Screw-on die, Ø 57-60 mm	0.029
06.521-6265	(1) Screw-on die, Ø 62-65 mm	0.033

**ASSORTMENT
SCREW-ON DIES SPECIAL LARGE DIAMETER**

ASSORTMENTS OF SCREW-ON DIES



Depth 14 mm,
angle of attack 45°

MSA	Packaging size	Kg
06.526	245 x 100 mm	0.320

Assortment of 12 Delrin® screw-on reversible dies FOR FITTING VERY DOMED CRYSTALS.

Assortment contents (brass centre thread Ø 6 mm) :

MSA	Item	Kg
06.526-18	Screw-on die, Ø 18 mm	0.005
06.526-20	Screw-on die, Ø 20 mm	0.005
06.526-24	Screw-on die, Ø 24 mm	0.010
06.526-28	Screw-on die, Ø 28 mm	0.011
06.526-30	Screw-on die, Ø 30 mm	0.012
06.526-35	Screw-on die, Ø 35 mm	0.017
06.526-40	Screw-on die, Ø 40 mm	0.021
06.526-45	Screw-on die, Ø 45 mm	0.025
06.526-50	Screw-on die, Ø 50 mm	0.030
06.526-55	Screw-on die, Ø 55 mm	0.034
06.526-60	Screw-on die, Ø 60 mm	0.040
06.526-65	(1) Screw-on die, Ø 65 mm	0.045

ASSORTMENT SCREW-ON DIES SPECIAL LARGE DEPTH



Universal inferior die



Curved die with
straight and thick edge

MSA	Packaging size	Kg
07.106	245 x 100 mm	0.136

Assortment of 9 Delrin® screw-on reversible dies FOR FITTING SNAP-ON CASE BACKS.

Assortment contents (brass centre thread Ø 6 mm) :

MSA	Item	Kg
07.106-17	Screw-on die, Ø 17 mm	0.004
07.106-1921	Screw-on die, Ø 19-21 mm	0.005
07.106-2225	Screw-on die, Ø 22-25 mm	0.006
07.106-2629	Screw-on die, Ø 26-29 mm	0.008
07.106-3033	Screw-on die, Ø 30-33 mm	0.010
07.106-3437	Screw-on die, Ø 34-37 mm	0.012
07.106-3841	Screw-on die, Ø 38-41 mm	0.015
07.106-4245	(2) Screw-on die, Ø 42-45 mm	0.017
07.106-U	(1) Universal screw-on inferior die, Ø 45 mm	0.014

ASSORTMENT SCREW-ON DIES



**ASSORTMENT
SCREW-ON DIES**

MSA	Packaging size	Kg
07.107	245 x 100 mm	0.154

Assortment of 5 Delrin® screw-on reversible dies "Special Large Diameter". This assortment contains several types of dies for large watches.

Contents :

- 2 dies Ø 40-45 and 46-50 mm for fitting bezels
- 1 die Ø 47-50 mm for fitting flat mineral crystals
- 2 dies Ø 46-48 et 49-50 mm for fitting snap-on case backs.

Assortment contents (brass centre thread Ø 6 mm) :

MSA	Item	Kg
07.106-4648	Screw-on die, Ø 46-48 mm	0.020
06.520-4750 (1)	Screw-on die, Ø 47-50 mm	0.031
06.521-4045	Screw-on die, Ø 40-45 mm	0.016
06.521-4650	Screw-on die, Ø 46-50 mm	0.020
07.106-4950	Screw-on die, Ø 49-50 mm	0.022



**ASSORTMENT
SCREW-ON DIES SPECIAL LARGE DIAMETER**

MSA	Packaging size	Kg
07.108	245 x 100 mm	0.170

Assortment of 5 Delrin® screw-on reversible dies FOR FITTING SNAP-ON CASE BACKS.

Assortment contents (brass centre thread Ø 6 mm) :

MSA	Item	Kg
07.106-4648 (1)	Screw-on die, Ø 46-48 mm	0.020
07.106-4950	Screw-on die, Ø 49-50 mm	0.022
07.106-5255	Screw-on die, Ø 52-55 mm	0.025
07.106-5760	Screw-on die, Ø 57-60 mm	0.029
07.106-6265	Screw-on die, Ø 62-65 mm	0.034

ASSORTMENTS OF SCREW-ON DIES



ASSORTMENT

MSA	Packaging size	Kg
06.530	155 x 135 x 35 mm	0.160

Assortment of 6 Delrin® screw-on rectangular dies for fitting snap-on case backs brass or rectangular crystals.
Brass centre thread Ø 6 mm.

Assortment contents (brass centre thread Ø 6 mm) :

MSA	Item	Kg
06.530-24	(1) Die, length ext. x int. 24 x 13 mm, width 13 mm, height 13 mm	0.005
06.530-29	Die, length ext. x int. 29 x 18 mm, width 16 mm, height 13 mm	0.006
06.530-34	Die, length ext. x int. 34 x 23 mm, width 19 mm, height 13 mm	0.008
06.530-39	Die, length ext. x int. 39 x 28 mm, width 22 mm, height 13 mm	0.010
06.530-44	Die, length ext. x int. 44 x 33 mm, width 25 mm, height 13 mm	0.012
06.530-49	Die, length ext. x int. 49 x 38 mm, width 28 mm, height 13 mm	0.015



SCREW-ON DIES

MSA	For watches	Size	Depth	Kg
06.511-A	(1) Gent / Medium	45 x 37 mm	11 mm	0.024
06.511-B	(2) Lady	37 x 30 mm	9 mm	0.018

Screw-on Delrin® inferior die for watches with pyramidal crystal CHRONO. The die is placed on the base of the press and the watch comes above upside down to close snap-on case back without damaging the pyramidal crystal.

Compatible with all previous illustrated presses as well as the presses MSA07.367, MSA07.368 and MSA07.369.

Brass centre thread Ø 6 mm.

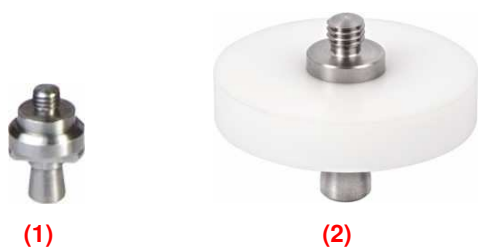

MSA	Items	Kg
07.373-A	(1) Upper adaptor Ø 16 mm	0.016
07.373-B	(2) Lower adaptor Ø 40 mm	0.089

Adaptor for presses MSA07.367, MSA07.368 and MSA07.369.

Use with all screw-on dies (thread 6 mm) of illustrated assortments above and on previous pages.

Assortments of Delrin® SNAP-ON dies. Compatible with presses MSA06.125, MSA06.130, MSA07.110, MSA07.150, MSA07.151 and MSA07.152.

Threading of snap-on dies is as follows :

- Ø 8 mm for superior dies
- Ø 5 mm for inferior dies.



ASSORTMENT

MSA	Packaging size	Kg
06.505	245 x 105 mm	0.155

Assortment of 12 Delrin® snap-on reversible dies FOR FITTING BEZELS.

Assortment contents :

MSA	Item	Kg
06.505-A12	Superior die, Ø 22.5 - 23.0 mm	0.004
06.505-A11	Superior die, Ø 24.0 - 25.0 mm	0.005
06.505-A10	Superior die, Ø 26.0 - 27.0 mm	0.006
06.505-A09	Superior die, Ø 28.0 - 29.0 mm	0.007
06.505-A08	Superior die, Ø 30.0 - 31.0 mm	0.007
06.505-A07	Superior die, Ø 32.0 - 32.5 mm	0.008
06.505-A06	Superior die, Ø 33.0 - 33.5 mm	0.009
06.505-A05	Superior die, Ø 34.0 - 34.5 mm	0.009
06.505-A04	Superior die, Ø 35.0 - 35.5 mm	0.011
06.505-A03	Superior die, Ø 36.0 - 36.5 mm	0.011
06.505-A02	Superior die, Ø 37.0 - 37.5 mm	0.011
06.505-A01	Superior die, Ø 38.0 - 38.5 mm	0.011



ASSORTMENT

MSA	Packaging size	Contents	Kg
07.112	120 x 106 mm	6 dies *	0.085
06.510	195 x 102 mm	10 dies	0.135

Assortment of Delrin® snap-on reversible dies FOR FITTING FLAT MINERAL CRYSTALS.

Assortments contents :

MSA	Item	Kg
06.510-A05	* Superior die, Ø 15.0 - 20.0 mm	0.003
06.510-A04	Superior die, Ø 17.5 - 22.5 mm	0.004
06.510-A03	* Superior die, Ø 25.0 - 30.0 mm	0.009
06.510-A02	Superior die, Ø 27.5 - 32.5 mm	0.011
06.510-A01	* Superior die, Ø 35.0 - 40.0 mm	0.017
-	-	-
06.510-B05	* Inferior die, Ø 15.0 - 20.0 mm	0.003
06.510-B04	Inferior die, Ø 17.5 - 22.5 mm	0.005
06.510-B03	* Inferior die, Ø 25.0 - 30.0 mm	0.009
06.510-B02	Inferior die, Ø 27.5 - 32.5 mm	0.011
06.510-B01	* Inferior die, Ø 35.0 - 40.0 mm	0.018

ASSORTMENTS OF SNAP-ON DIES



ASSORTMENT

MSA	Packaging size	Contents	Kg
07.111	195 x 102 mm	6 dies *	0.100
07.113	120 x 106 mm	6 dies **	0.085
07.116	195 x 102 mm	13 dies ***	0.155

Assortment of Delrin® reversible snap-on dies FOR FITTING SNAP-ON CASE BACKS.

Assortments contents :

MSA	Item	Kg
07.111-A03	*/** Superior die, Ø 20 - 23 mm	0.004
07.111-A02	*/** Superior die, Ø 26 - 29 mm	0.007
07.111-A01	*/** Superior die, Ø 32 - 35 mm	0.010
07.111-A08	*** Superior die, Ø 36 - 38 mm	0.012
07.111-A07	*** Superior die, Ø 39 - 41 mm	0.014
07.111-A06	*** Superior die, Ø 42 - 44 mm	0.016
07.111-A05	*** Superior die, Ø 45 - 47 mm	0.018
07.111-A04	*** Superior die, Ø 48 - 50 mm	0.020
07.111-A09	** Superior die, Ø 52 - 55 mm	0.024
07.111-A10	** Superior die, Ø 57 - 60 mm	0.029
07.111-A11	** Superior die, Ø 62 - 65 mm	0.033
-	-	-
07.111-B03	*/** Inferior die, Ø 29 mm	0.009
07.111-B02	*/** Inferior die, Ø 35 mm	0.012
07.111-B06	*/** Inferior die, Ø 40 mm	0.014
07.111-B05	*** Inferior die, Ø 45 mm	0.018
07.111-B04	*** Inferior die, Ø 50 mm	0.022
07.111-B07	** Inferior die, Ø 55 mm	0.026
07.111-B08	** Inferior die, Ø 60 mm	0.030
07.111-B09	** Inferior die, Ø 65 mm	0.035

Wheel press.



MSA	Size	Kg
07.050	200 x 200 x 425 mm	7.680

The strongest wheel press arm in its class.
 Ideal for opening and closing the most recalcitrant screw-on backs.
 Its extreme robustness and long stroke make it a perfect adaptable tool.
 The monobloc design of this press guarantees optimal alignment.
 The ergonomic wheel provides great working strength and is suitable for both right- and left-handed users.

Compatible with all HOROTEC® dies and case holders, see pages 07-25...07-28 and 07-30...07-32.

Professional rack-press equipped with 1 case holder and suction dies, for opening and closing watches with screw-on back cases. Thanks to this combined system, there is no contact between the metallic parts and the watch, thus eliminating any risk of scratching.

The case holder is made of a high adherence red synthetic deformable material ; inverted cone shape allows firmly holding in place all types of watches ; neither the crowns nor the pushers don't undergo any pressure.

Holding watches with domes glass is not a problem anymore. The suction dies, delivered in different diameters and made of the same red synthetic deformable material, allow to operate on all different types of case backs even the most delicately worked (satin-like, transparent, etc.). The highly adherence material is easily distorted and adapts easily to the case back shape. In order to maintain good adherence of the suction dies, they must be cleaned regularly ; eliminate previous traces of arease or dust on the glass, the case and the case back before proceeding.



MSA07.368

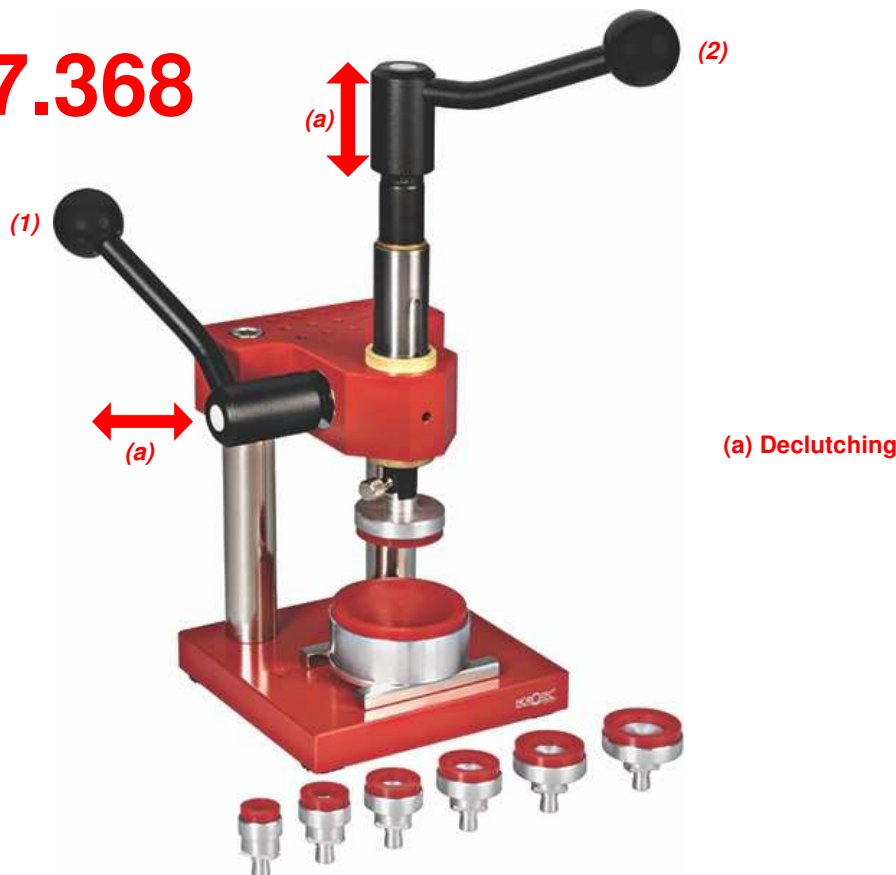

MSA	Size	Kg
07.368	180 x 130 x 350 mm	4.400

Professional rack-press, version with red suction dies.

The press is equipped with two handles that can be declutched to facilitate their positioning according to the desired angle :

(1) Lateral handle allows to lower or to lift the toothed rack in order to have a better control of the pressure applied to the case back during unscrewing/screwing ;

(2) Upper handle (mobile) is used to unscrew/screw the case back.

Compatible with all HOROTEC® dies and case holders, see pages 07-25...07-28 and 07-30...07-32.

Contents :

MSA	Item	Kg
07.333	Assortment of 7 red suction dies	0.140
07.367-A	Red suction case holder	0.130
07.367-P	Rack-press	4.000

Spare part :

MSA	Item	Kg
07.367-R	Lateral spring for press, Ø 18 x H 13 mm	0.005

Professional rack-press, full version.



MSA07.369



MSA	Size	Kg
07.369	180 x 130 x 350 mm	6.750

Rack-press delivered as a full version, for traditional work or only with the suction dies. Equipped with 2 adapters allowing use of all the dies with thread Ø 6 mm from the following assortments: MSA06.520, MSA06.521, MSA06.522, MSA07.106 and MSA07.107.

Compatible with all HOROTEC® dies and case holders, see pages 07-25...07-28 and 07-30...07-32.

Contents :

MSA	Item	Kg
07.367-P	Rack-press	4.000
07.367-A	(1) Red suction case holder	0.130
07.344	(2) Adjustable jaws holder, maximum opening 65 mm	0.225
07.323-A	(3) 2x round jaws	0.003
07.323-B	(3) 2x flat jaws	0.003
07.323-C	(3) 2x square jaws	0.003
07.323-D	(3) 2x knurled jaws	0.003
07.323-E	(3) 2x elongated jaws, reinforced square	0.004
07.323-F	(3) 2x elongated jaws, reinforced round	0.004
07.371	(4) Lower tray	0.220
07.372	(5) 2x upper tray	0.325
07.373-A	(6) Upper adaptor Ø 16 mm (see page 07-14)	0.016
07.373-B	(7) Lower adaptor Ø 40 mm (see page 07-14)	0.089
07.374	(8) Case holder with 4 stacked jaws, height 29 mm	0.160
07.333	(9) Assortment of 7 red suction dies	0.140
07.311	(10) Assortment of 8 steel dies	0.510
07.327	(11) Assortment of 3 steel dies BM type	0.220
07.336	(12) Assortment of 4 steel dies SEAM. type	0.582
10.524	Pin punch support, Ø 8 x L35 mm	0.012

Spare part :

MSA	Item	Kg
07.367-R	Lateral spring for press, Ø 18 x H 13 mm	0.005

Professional rack-press, light version.



MSA07.367

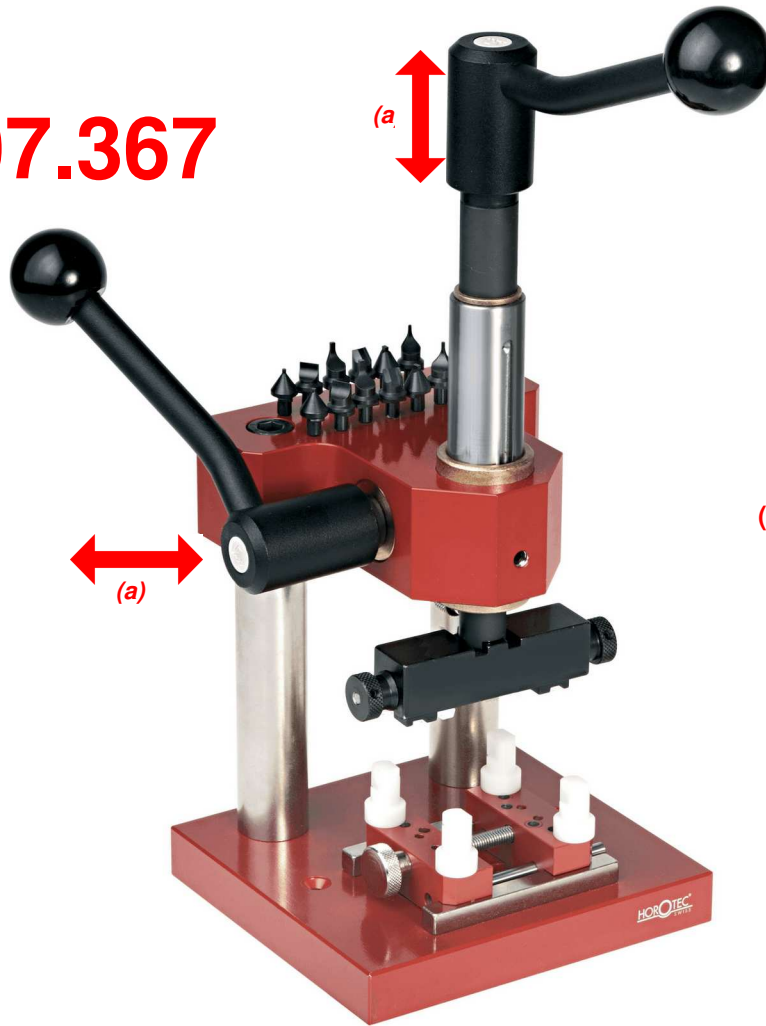

(a) Declutching

MSA	Size	Kg
07.367	180 x 130 x 350 mm	4.500

Rack-press delivered in the light version, to work in a traditional way.

Compatible with all HOROTEC® dies and case holders, see pages 07-25...07-28 and 07-30...07-32.

Contents :

MSA	Item	Kg
07.323-E	2x elongated jaws, reinforced square	0.004
07.323-F	2x elongated jaws, reinforced round	0.004
07.374	Case holder with 4 stacked jaws, height 29 mm	0.160
07.323-A	2x round jaws	0.003
07.323-B	2x flat jaws	0.003
07.323-C	2x square jaws	0.003
07.323-D	2x knurled jaws	0.003
07.344	Adjustable jaws holder, maximum opening 65 mm	0.225
07.367-P	Rack-press	4.000

Spare part :

MSA	Item	Kg
07.367-R	Lateral spring for press, Ø 18 x H 13 mm	0.005

Complete version of the professional precision HOROTEC® press, heavy and robust for opening/closing screw-on case backs of all types of watches.

- The professional precision HOROTEC® press is deliverable in 4 different versions

- The references of the 4 pairs of jaws MSA07.323-x delivered with the illustrated presses here below are the following : MSA07.323-A, -B, -C and -D

- The jaws MSA07.323-E and -F are also compatible and available separately.



Dies can be used upside down.

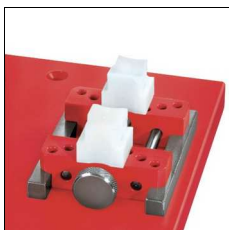

Case lugs jaws can be used. (See page 07-28)

MSA	Size	Kg
07.363	160 x 220 x 280 mm	5.035

Features :

- Large ergonomic top wheel Ø 160 mm for screwing/unscrewing with no effort
- Centre threaded broach with precise blocking ring
- Solid steel supporting pillars covered with anti-skid and ergonomic synthetic material, for right and left handed
- Base has a removable die tray for easy selection and storage
- Removable watch holder with 12 holes for concave Delrin® dies and 4 holes for case lugs dies
- Base equipped with 4 anti-skid feet.

Compatible with all HOROTEC® dies and case holders, see pages 07-25...07-28 and 07-30...07-32.

Contents :

MSA	Item	Kg
07.311	Assortment of 8 steel dies	0.510
07.323-A	2x round jaws	0.003
07.323-B	2x flat jaws	0.003
07.323-C	2x square jaws	0.003
07.323-D	2x knurled jaws	0.003
07.325	Assortment of 7 blue suction dies	0.320
07.327	Assortment of 3 steel dies BM type	0.220
07.344	Adjustable jaws holder, maximum opening 65 mm	0.225
07.360-A	Adjustable case holder with 4 Delrin® dies	0.110
07.375	Removable dies holder tray	0.385

Other variants of the complete version MSA07.363.



MSA	Size	Kg
07.360	160 x 220 x 280 mm	4.700

Press delivered with :

- 1 adjustable case holder MSA07.360-A
- 1 adjustable jaws holder MSA07.344
- 4 pairs of jaws MSA07.323-x.

Compatible with all HOROTEC® dies and case holders, see pages 07-25...07-28 and 07-30...07-32.



MSA	Size	Kg
07.361	160 x 220 x 280 mm	4.145

Press delivered with :

- 1 adjustable case holder MSA07.360-A
- 1 adjustable jaws holder MSA07.344
- 4 pairs of jaws MSA07.323-x
- 7 suction dies MSA07.325-x.

Compatible with all HOROTEC® dies and case holders, see pages 07-25...07-28 and 07-30...07-32.



MSA	Size	Kg
07.364	160 x 220 x 280 mm	4.155

Press delivered with :

- 1 adjustable case holder MSA07.360-A
- 1 adjustable jaws holder MSA07.344
- 4 pairs of jaws MSA07.323-x
- 1 assortment of 8 steel dies MSA07.311.

Compatible with all HOROTEC® dies and case holders, see pages 07-25...07-28 and 07-30...07-32.



MSA	Size	Kg
07.365	160 x 220 x 280 mm	4.030

Press delivered with :

- 1 adjustable case holder MSA07.360-A
- 1 adjustable jaws holder MSA07.344
- 4 pairs of jaws MSA07.323-x
- 1 assortment of 3 steel dies BM type MSA07.327.

Compatible with all HOROTEC® dies and case holders, see pages 07-25...07-28 and 07-30...07-32.

Accessories.

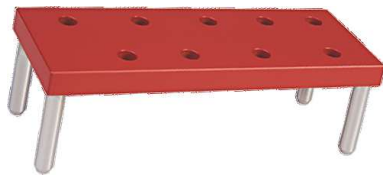

MSA	Size	Kg
07.370	160 x 55 x 53 mm	0.345

Removable dies holder tray for presses MSA07.360, MSA07.361, MSA07.363, MSA07.364 and MSA07.365.



MSA	Size	Kg
07.375	160 x 72 x 53 mm	0.385

Removable dies holder tray for presses MSA07.360, MSA07.361, MSA07.363, MSA07.364 and MSA07.365.



MSA	Size	Kg
07.372	160 x 55 x 46 mm	0.325

Upper dies holder tray, accessory for presses MSA07.367, MSA07.368 and MSA07.369.
Can be stacked on lower tray MSA07.371.



MSA	Size	Kg
07.371	160 x 55 x 10 mm	0.220

Lower dies holder tray, accessory for presses MSA07.367, MSA07.368 and MSA07.369.
Used as base support for various upper trays MSA07.372.



MSA	Kg
07.360-H	0.125

Adapter for OM broach. Fits on presses MSA07.360, MSA07.361, MSA07.363, MSA07.364 and MSA07.365.

Mini HOROTEC® professional precision press.



MSA	Size	Kg
07.320	110 x 95 x 200 mm	1.900

Mini professional precision press. Small and robust, built in steel and aluminium. Equipped with removable and adjustable watch holder with 4 Delrin® dies to hold the watch cases surely and horizontally. First fit the case in the watch holder and then unscrew the case back with the adjustable jaws holder. Excellent frontal, lateral or plunging view. Top wheel Ø 75 mm.

Several accessories are available as an option. Compatible with all HOROTEC® dies and case holders, see pages 07-25...07-28 and 07-30...07-32.

Contents :

MSA	Item	Kg
07.320-A	Gasket for broach	0.001
07.323-A	2x round jaws	0.003
07.323-B	2x flat jaws	0.003
07.323-C	2x square jaws	0.003
07.323-D	2x knurled jaws	0.003
07.344	Adjustable jaws holder, maximum opening 65 mm	0.225
07.360-A	Adjustable case holder with 4 Delrin® dies	0.110

Assortment of suction dies with increased adherence for opening/closing screw-on case backs, in red synthetic material (more flexible than the blue suction dies MSA07.325) drowned in aluminium.

Slightly deformable material that adapts to the case back shape. For optimal adherence, remove all traces of grease or dust on the synthetic material and the case back, using a cloth soaked with alcohol or benzene.

Compatible with all presses MSA07.050, MSA07.170, MSA07.320 and MSA 07.36x.



ASSORTMENT



MSA	Contents	Ø	Kg
07.343	10 dies	16...55 mm	0.180

Assortment of 10 red suction dies.
Delivered in a cardboard box.

Detail of dies :

MSA	Item	Kg
07.333-016	Suction die Ø 16 mm	0.011
07.333-020	Suction die Ø 20 mm	0.013
07.333-023	Suction die Ø 23 mm	0.016
07.333-026	Suction die Ø 26 mm	0.018
07.333-030	Suction die Ø 30 mm	0.022
07.333-034	Suction die Ø 34 mm	0.026
07.333-040	Suction die Ø 40 mm	0.032
07.333-045	Suction die Ø 45 mm	0.040
07.333-050	Suction die Ø 50 mm	0.045
07.333-055	Suction die Ø 55 mm	0.050



ASSORTMENT

MSA	Contents	Ø	Kg
07.333	7 dies	16...40 mm	0.140

Assortment of 7 red suction dies.
Delivered in a cardboard box.

Detail of dies :

MSA	Item	Kg
07.333-016	Suction die Ø 16 mm	0.011
07.333-020	Suction die Ø 20 mm	0.013
07.333-023	Suction die Ø 23 mm	0.016
07.333-026	Suction die Ø 26 mm	0.018
07.333-030	Suction die Ø 30 mm	0.022
07.333-034	Suction die Ø 34 mm	0.026
07.333-040	Suction die Ø 40 mm	0.032



ASSORTMENT

MSA	Contents	Ø	Kg
07.339	3 dies	45...55 mm	0.178

Assortment of 3 red suction dies.
Delivered in a cardboard box.

Detail of dies :

MSA	Item	Kg
07.333-045	Suction die Ø 45 mm	0.040
07.333-050	Suction die Ø 50 mm	0.045
07.333-055	Suction die Ø 55 mm	0.050

PRESSES FOR SCREW / UNSCREW CASE BACKS



ASSORTMENT

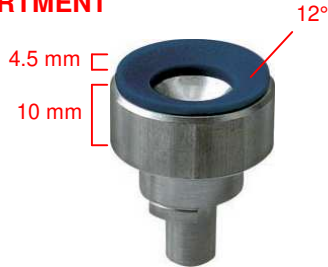

MSA	Contents	Ø	Kg
07.325	7 dies *	16...40 mm	0.178

Assortment of 7 suction dies for opening/closing screw-on case backs. Made of non-deformable blue synthetic material, drowned in aluminium for a perfect adherence and durable use. Adaptable on presses MSA07.050, MSA07.170, MSA07.320 and MSA07.36x.

Delivered in a cardboard box.

Detail of dies :

MSA	Item	Kg
07.325-016	* Suction die Ø 16 mm	0.012
07.325-020	* Suction die Ø 20 mm	0.014
07.325-023	* Suction die Ø 23 mm	0.016
07.325-026	* Suction die Ø 26 mm	0.019
07.325-030	* Suction die Ø 30 mm	0.023
07.325-034	* Suction die Ø 34 mm	0.027
07.325-040	* Suction die Ø 40 mm	0.034
07.325-045	Suction die Ø 45 mm	0.040

Jaws holder and jaws.

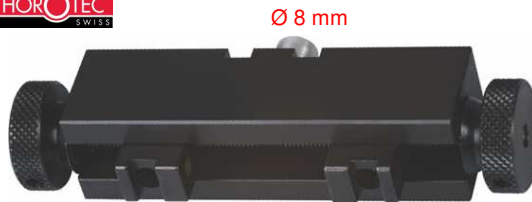

← 65 mm →

MSA	Maximun opening	Kg
07.344	65 mm	0.225

Adjustable jaws holder for professional precision presses MSA07.050, MSA07.320 and MSA07.36x. Compatible with all jaws MSA07.323-x.

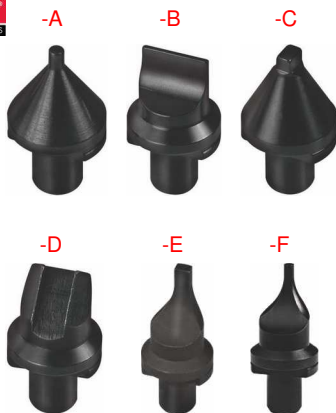

Ø 5 mm

MSA	Jaws shape	Kg
07.323-A	Round	0.003
07.323-B	Flat	0.003
07.323-C	Square	0.003
07.323-D	Knurled	0.003
07.323-E	Square, elongated	0.004
07.323-F	Round, elongated	0.004

Jaws for screw-on case backs, accessories for jaws holder MSA07.344 of presses MSA07.050, MSA07.320 and MSA07.36x.

Case holders.



← 70 mm →

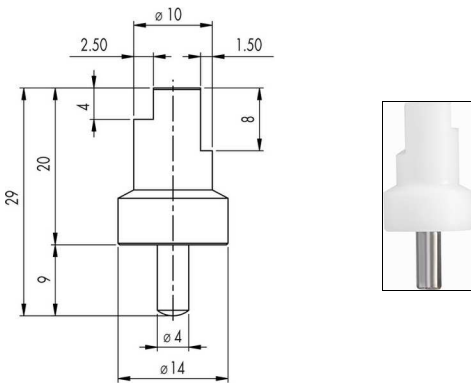

MSA	Maximun opening	Kg
07.374	70 mm	0.160

Adjustable aluminium case holder for all HOROTEC® presses. The stacked dies are fitted in reinforced pierced holes with a steel cylinder. They are particularly recommended for heavy-duty work. Delivered with 4 Delrin® dies MSA07.374-A.

Spare part :

MSA	Item	Kg
07.374-A	Stacked Delrin® die	0.005

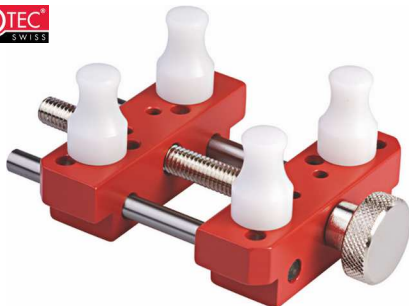

← 70 mm →

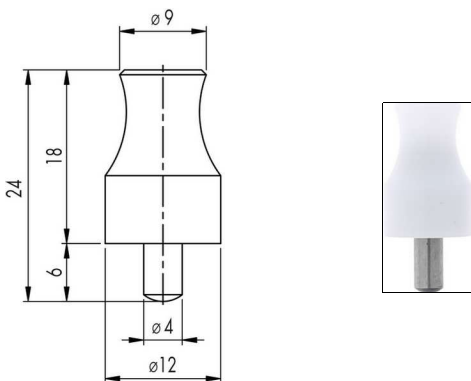

MSA	Maximun opening	Kg
07.360-A	70 mm	0.110

Adjustable aluminium case holder for all HOROTEC® presses. Delivered with 4 Delrin® dies MSA07.360-B.

Spare part :

MSA	Item	Kg
07.360-B	Delrin® die	0.015

PRESSES FOR SCREW / UNSCREW CASE BACKS



∅ 4 mm

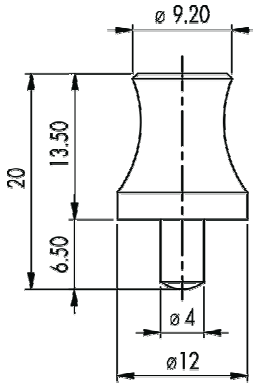

MSA

Kg

07.322

0.002

Concave Delrin® die, accessory for case holders MSA07.360-A and MSA07.374.



← 70 mm →

MSA

Kg

07.367-A

0.130

Case holder with red suction cup.

- ∅ external aluminium : 66 mm
- External ∅ of the suction cup : 64 mm
- Suction cup depth : 25 mm.

For presses MSA07.050, MSA07.060, MSA07.170, MSA07.360, MSA07.361, MSA07.363, MSA07.364, MSA07.365, MSA07.367, MSA07.368 and MSA07.369.

HOROTEC® case openers. Simple and very efficient for opening watch screw-on case backs with integrated bracelets (also for ladies watches where work space is very narrow). For watches with large dimensions due to the opening up to 65 mm.



← 65 mm →



MSA	Length	Maximun opening	Kg
07.013	190 mm	65 mm	0.295

Case opener delivered with 1 pair of jaws MSA07.323-E.
Use with jaws MSA07.323-x as shown on page 07-26.



← 57 mm →



MSA	Length	Maximun opening	Kg
07.014	155 mm	57 mm	0.340

Case opener delivered with 1 pair of jaws MSA07.323-E.
Use with jaws MSA07.323-x as shown on page 07-26.

These dies are adaptable on all HOROTEC® presses for screw-on case backs.



MSA	Kg
07.312	0.645

Assortment of 8 steel dies MSA07.311 with handle for opening /closing screw-on case backs.

Spare parts :

MSA	Item	Kg
07.305	Handle	0.270
07.305-A	Screw for handle	0.008
07.311	Assortment of 8 steel dies	0.510

ASSORTMENT



MSA	Ø	Kg
07.311	18.5...36.5 mm	0.510

Assortment of 8 steel dies for opening/closing screw-on case backs.

Spare parts :

MSA	Item	Kg
07.326-185	Die Ø 18.5 mm	0.037
07.326-202	Die Ø 20.2 mm	0.043
07.326-225	Die Ø 22.5 mm	0.047
07.326-265	Die Ø 26.5 mm	0.056
07.326-283	Die Ø 28.3 mm	0.058
07.326-295	Die Ø 29.5 mm	0.064
07.326-340	Die Ø 34.0 mm	0.080
07.326-365	Die Ø 36.5 mm	0.090

ASSORTMENT

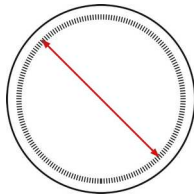

MSA	Kg
07.307	0.442

Assortment of 3 steel dies MSA07.327 with handle for opening /closing screw-on case backs BM type.

Spare parts :

MSA	Item	Kg
07.305	Handle	0.270
07.305-A	Screw for handle	0.008
07.327	Assortment of 3 steel dies BM type	0.220

ASSORTMENT



-033

-030

-025

ASSORTMENT

MSA	Ø	Kg
07.327	25...33 mm	0.220

Assortment of 3 steel dies for opening/closing screw-on case backs BM type.

Spare parts :

MSA	Item	Kg
07.327-025	Die Ø ext. 25 mm	0.047
07.327-030	Die Ø ext. 30 mm	0.059
07.327-033	Die Ø ext. 33 mm	0.067



ASSORTMENT

MSA	Kg
07.308	0.820

Assortment of 8 steel dies MSA07.311 and 3 steel dies MSA07.327 with handle for opening/closing screw-on case backs BM type.

Spare parts :

MSA	Item	Kg
07.305	Handle	0.270
07.305-A	Screw for handle	0.008
07.311	Assortment of 8 steel dies	0.510
07.327	Assortment of 3 steel dies BM type	0.220



ASSORTMENT

MSA	Kg
07.337	0.826

Assortment of 4 steel dies MSA07.336 with handle MSA07.305 for opening/closing screw-on case backs SEAM. type.

Spare parts :

MSA	Item	Kg
07.305	Handle	0.270
07.305-A	Screw for handle	0.008
07.336	Assortment of 4 dies SEAM. type	0.582

TOOLS FOR SCREW / UNSCREW CASE BACKS



-042 -033 -030 -020

ASSORTMENT

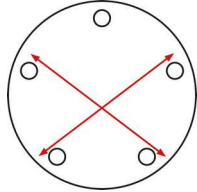

MSA	Ø	Kg
07.336	20...42 mm	0.582

Assortment of 4 steel dies for opening/closing screw-on case backs SEAM type.

Spare parts :

MSA	Item	Kg
07.330-020	Die SEAM. type, lady Ø 20 mm	0.095
07.330-030	Die SEAM. type, gent Ø 30 mm	0.095
07.330-033	Die SEAM. type, Ø 33 mm	0.140
07.330-042	Die SEAM. type, Ø 42 mm	0.141



-034 -035 -036A



-036 -037 -038

ASSORTMENT

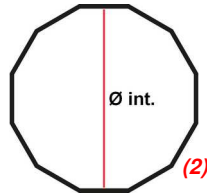
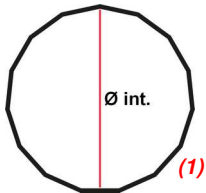

MSA	Ø	Kg
07.335	34...38 mm	0.260

Assortment of 6 steel dies for opening/closing screw-on case backs BR type.

Spare parts :

MSA	Items	Ø	Kg
07.335-034	(1) Die BR type with 15 sides	34.00 mm	0.037
07.335-035	(1) Die BR type with 15 sides	35.00 mm	0.038
07.335-036A	(2) Die BR type with 12 sides	36.00 mm	0.042
07.335-036	(1) Die BR type with 15 sides	36.00 mm	0.041
07.335-037	(1) Die BR type with 15 sides	37.00 mm	0.041
07.335-038	(1) Die BR type with 15 sides	38.00 mm	0.042



-030 -035 -039 -042

ASSORTMENT

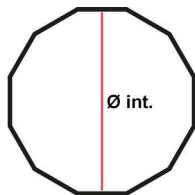

MSA	Ø	Kg
07.334	30.60...42.50 mm	0.532

Assortment of 4 steel dies for opening/closing screw-on case backs PAN type.

Spare parts :

MSA	Items	Ø	Kg
07.334-030	Die PAN type with 12 sides	30.60 mm	0.089
07.334-035	Die PAN type with 12 sides	35.55 mm	0.107
07.334-039	Die PAN type with 12 sides	39.00 mm	0.104
07.334-042	Die PAN type with 12 sides	42.50 mm	0.125



MSA	Ø	Kg
07.331	35 mm	0.070

Steel die for opening/closing screw-on case backs CT Aqualand type.

Other openers for screw-on case backs.



MSA	Size	Kg
07.210	70 x 37 mm	0.080

Case opener with 2 hardened steel jaws for opening/closing cases with screwed-on backs.



MSA	Size	Kg
07.208	70 x 37 mm	0.080

Case opener with 2 flat hardened steel jaws for opening/closing cases with screwed-on backs.



MSA	Size	Kg
07.209	70 x 37 mm	0.080

Case opener with 2 pointed hardened steel jaws for opening/closing cases with screwed-on backs.



MSA	Ø	Kg
07.022	± 65 mm	0.042

Friction ball with high adherence for opening/closing cases with screwed-on backs.

Case openers for snap-on case backs.



MSA	Length	Kg
07.004	122 mm	0.165

Automatic case opener for snap-on case backs. Handle inside equipped with a spring and firing pin, when turned on opens the case backs in one micro-choc. The strength of the choc is adjustable by screwing (+ power) or unscrewing (- power) the handle. *Delivered with 3 shaped blades.*

Spare parts :

MSA	Item	Kg	
07.004-01	Assortment of 3 blades	0.012	
07.004-A	Straight blade, width 5 mm	0.004	
07.004-B	Bended blade, width 3.5 mm	0.004	
07.004-C	Bended blade, width 4.5 mm	0.004	
07.004-D	O'Ring gasket	0.001	
07.004-E	Spring small model	0.002	
07.004-G	Blades holder	0.008	
07.004-H	Spring large model	0.003	
07.004-J	Hammer	0.005	



MSA	Type	Length	Kg
07.026	Right-handed user	137 mm	0.106

Case opener with knurled aluminium handle allowing an excellent grip for opening cases with snapped-on backs. Interchangeable stainless steel blade. *Delivered with an Allen key for blade changing.*

Spare parts :

MSA	Item	Kg	
07.026-B	Blade	0.004	
07.026-V	Screw	0.001	



MSA	Length	Kg
07.001	115 mm	0.028

Case opener with aluminium handle and one stainless steel fixed blade for opening cases with snapped-on backs.



MSA	Length	Kg
07.016	113 mm	0.018

Case opener with plastic handle and one stainless steel fixed blade without rivets for opening cases with snapped-on backs.



MSA	Length	Kg
07.007	135 mm	0.034

Lever case opener with robust handle for a better grip for opening cases with snapped-on backs.

SEIKO



MSA		Length	Kg
07.018	■	82 mm	0.024
07.019	●	86 mm	0.022
07.020	●	85 mm	0.021

Robust case opener with plastic handle and one stainless steel fixed blade for opening cases with snapped-on backs.



MSA	Packaging size	Kg
07.024	155 x 145 x 37 mm	0.230

Assortment of 4 case openers with plastic handle and one stainless steel blade for opening cases with snapped-on backs.

Spare parts :

MSA	Item	Kg	
07.024-A	Case opener, length 87 mm, blade width 10 mm	0.026	
07.024-B	Case opener, length 87 mm, blade width 4 mm	0.024	
07.024-C	Case opener, length 87 mm, blade width 10 mm	0.026	
07.024-D	Case opener, length 87 mm, blade width 4 mm	0.024	

ASSORTMENT

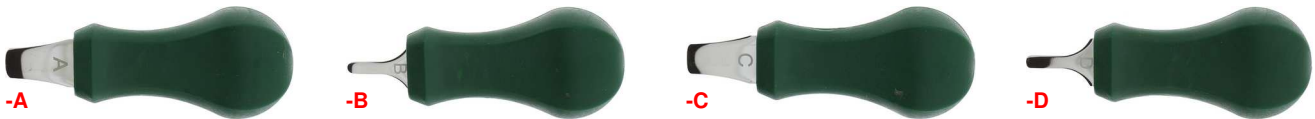

PRECITEC QUALITY



MSA	Length closed	Kg
07.025	83 mm	0.041

Robust case opener with white aluminium handle and 2 retract-able stainless steel blades for opening cases with snapped-on backs.



MSA	Colour	Length closed	Kg
07.006-01	●	83 mm	0.036
07.006-02	●	83 mm	0.036
07.006-03	●	83 mm	0.036
07.006-05	□	83 mm	0.036

Robust case opener with 2 retract-able stainless steel blades. Thick plastic handle for opening cases with snapped-on backs.

SEIKO



MSA	Size	Kg
07.009	100 x 160 x 100 mm	0.470

Adjustable case opener for all types of cases with snapped-on backs.
 Delivered with users manual and spare blade.

Spare parts :

MSA	Item	Kg
07.009-01	(1) Pair of blades	0.004
07.009-02	(2) Pair of pins without protection	0.004

Tools for opening snap-on case backs and extracting snap-on bezels.

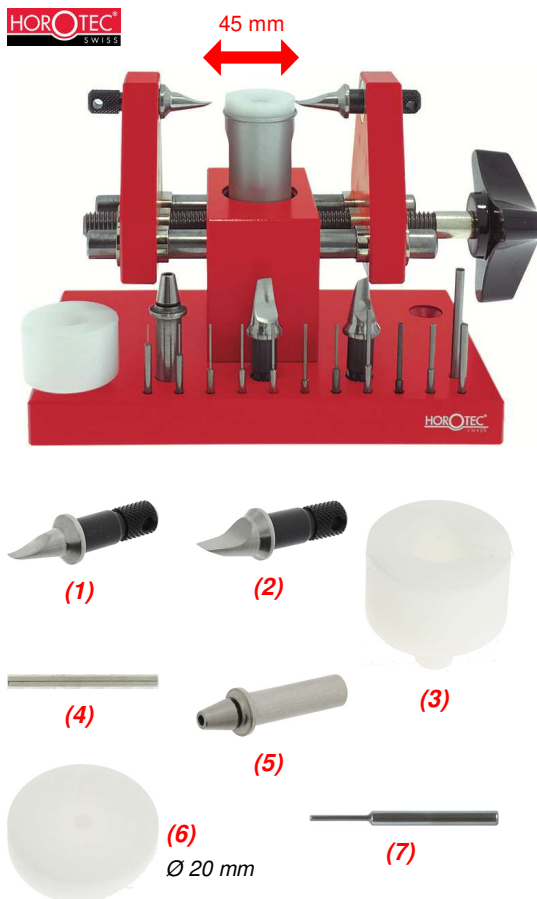

MSA	Size	Maximun opening	Kg
07.115	120 x 75 x 85 mm	45 mm	0.960

Tool for opening snap-on watch case backs and removing snap-on bezels. Allows a precise adjustment due to an anti-skid case holder mounted on a spring. The tool is equipped with precision sliding carriage for delicately extracting of glasses or recalcitrant case backs.
 Delivered with 2 pairs of hardened steel polished blades, 1 bored case-supporting Delrin® die to avoid damaging crowns and pushers.

Spare parts :

MSA	Item	Kg
07.115-A	(1) Hardened steel blade, width 2 mm Hardness 54-56 HRC	0.009
07.115-B	(2) Hardened steel blade, width 4 mm Hardness 54-56 HRC	0.009
07.115-C	(3) Case-supporting die, hole Ø 10 mm	0.009
07.115-D	(4) Hardened steel stem, Ø 2.5 x length 40 mm	0.010
07.115-E	(5) Pin punch holder, length 36 mm	0.010
07.115-G	(6) Delrin® pad for central column, Ø 20 mm	0.002
10.503-A	(7) Assortment of 11 pin punches : MSA10.503-040, -060, -070, -080, -090, -100, -110, -120, -140, -150 and -200 (Ø 0.40...2.00 mm)	0.060

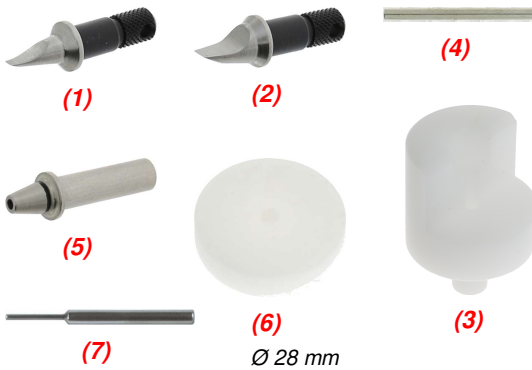

MSA	Size	Maximun opening	Kg
07.119	155 x 100 x 110 mm	60 mm	1.500

Same functions as the tool MSA07.115 tool but with a maximum opening of 60 mm instead of 45 mm for the MSA07.115. Equipped with a screw for stabilizing the table at the desired height.

Spare parts :

MSA	Item	Kg
07.115-A	(1) Hardened steel blade, width 2 mm Hardness 54-56 HRC	0.009
07.115-B	(2) Hardened steel blade, width 4 mm Hardness 54-56 HRC	0.009
07.115-D	(4) Hardened steel stem, Ø 2.5 x length 40 mm	0.010
07.115-E	(5) Pin punch holder, length 36 mm	0.010
07.119-C	(3) Case-supporting die, hole Ø 10 mm	0.009
07.119-G	(6) Delrin® pad for central column, Ø 28 mm	0.002
10.503-A	(7) Assortment of 11 pin punches : MSA10.503-040, -060, -070, -080, -090, -100, -110, -120, -140, -150 and -200 (Ø 0.40...2.00 mm)	0.060



← 40 mm →

PAIR

MSA	Maximun opening	Kg
07.115-F	40 mm	0.085

Pair of adaptors with 2 mirror polished blades adaptable to MSA07.115 and MSA07.119, allowing the extraction of bezels or opening recalcitrant case backs delicately.

Spare part :

MSA	Item	Kg
07.117-A	Blade (delivered individually)	0.006



Tools for removing bezels.



MSA	Size	Kg
07.117	150 x 60 x 65 mm	0.885

Tool for removing bezels up to Ø 60 mm.
Provided with 4 interchangeable hardened mirror polished steel blades.

Spare part :

MSA	Item	Kg
07.117-A	Blade (delivered individually)	0.006



MSA	Kg
07.031	0.030

Rubber tool for extracting rotating bezels from Ø 38 to 45 mm.

Tools for Swatch® battery covers.



MSA	Length	For watch	Kg
07.010	120 mm	Gent	0.072
07.012	120 mm	Medium	0.072
07.011	120 mm	Lady	0.071

Tool for Swatch® battery covers.

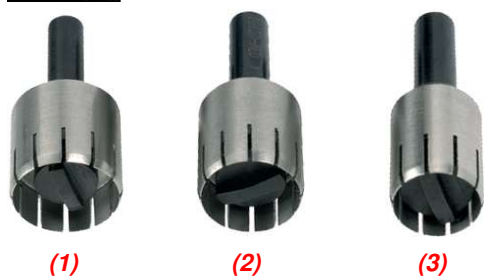

MSA	For watch	Kg
03.620-GENT (1)	Gent	0.015
03.620-MED (2)	Medium	0.015
03.620-LADY (3)	Lady	0.015

Interchangeable key to fit in the handle MSA03.620-A.



MSA	Kg
03.620-A	0.060

Hexagonal handle on which all types of here above keys and those illustrated on chapter 03 can be fitted.



See chapter PERF.

