

15



MEASURING INSTRUMENTS WITH FIXED DIMENSIONS

15 - 2

MEASURING INSTRUMENTS WITH VARIABLE DIMENSIONS

15 - 8



Rules and gauges.



MSA	Length	Graduations	Kg
15.001	150 mm	1 mm	0.009

Stainless steel flexible rule.



(1)



(2)

MSA	Length	Graduations	Kg
15.008-150 (1)	150 mm	0.5 / 1 mm	0.009
15.008-200 (2)	200 mm	0.5 / 1 mm	0.011

Stainless steel flexible rule. Double sided graduations.



MSA	Length	Graduations	Kg
15.003	120 mm	8...22 mm	0.003

Aluminium tool for measuring the distance between the lugs.

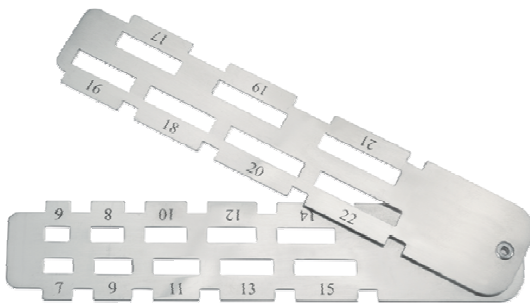

MSA	Length	Graduations	Kg
15.004	125 mm	6...22 mm	0.034

Tool with 2 arms for measuring the width of bracelets and the distance between the lugs.

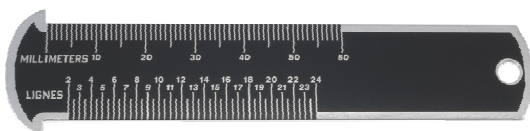

MSA	Length	Kg
15.005	110 mm	0.006

Gauge for measuring the diameter (0...60 mm) or the number of lines of movements (2...24'').

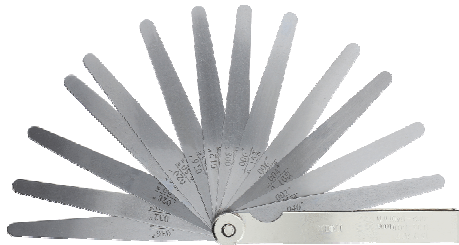

(1)

MSA		Number of blades	Kg
15.014-13	(1)	13	0.066
15.014-20	(2)	20	0.100

Stainless steel thickness gauge.

MSA15.014-13 = 13 blades from 0.05 to 1.00 mm : 0.05 - 0.10 - 0.15 - 0.20 - 0.25 - 0.30 - 0.40 - 0.50 - 0.60 - 0.70 - 0.80 - 0.90 - 1.00 mm.

MSA15.014-20 = 20 blades from 0.05 to 1.00 mm : 0.05 - 0.10 - 0.15 - 0.20 - 0.25 - 0.30 - 0.35 - 0.40 - 0.45 - 0.50 - 0.55 - 0.60 - 0.65 - 0.70 - 0.75 - 0.80 - 0.85 - 0.90 - 0.95 - 1.00 mm.

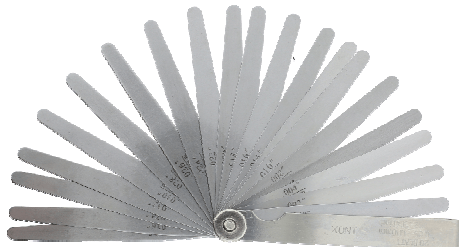

(2)

Bevelled straight edges.



MSA	Length	Straightness error	Kg
15.006	75 mm	2 µm	0.060
15.016	100 mm	2 µm	0.110

Hardened steel bevelled straight edge.

Model with 1 bevelled edge, with insulating grip to limit the transfer of thermal heat during manual handling for optimal precision.

Delivered in 1 synthetic pouch.

Divider.

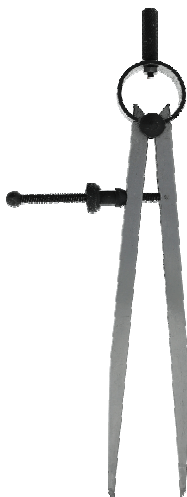

← 165 mm →

MSA	Length	Kg
15.205	200 mm	0.133

Stainless steel adjustable divider, straight tips.

Maximum opening : 165 mm.

Squares.



MSA	Size	Kg
15.085	50 x 40 mm	0.060
15.084	75 x 50 mm	0.072

Bevelled edge 90° square in hardened stainless steel.
Measuring faces fine scraped and lapped.
Accuracy according to DIN 875/00.



MSA	Size	Kg
15.086	100 x 70 mm	0.210

Flat and try 90° square in hardened stainless steel.
Lapped measuring faces.
Accuracy according to DIN 875.
Section 20 x 5 mm.

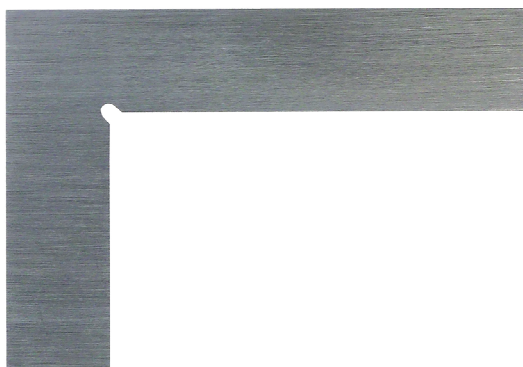

MSA	Size	Kg
15.087	150 x 100 mm	0.282

Simple 90° square in hardened stainless steel.
Lapped measuring faces.
Accuracy according to DIN 875.
Section 25 x 7 mm.

CARY® steel plug gauges TDH type.

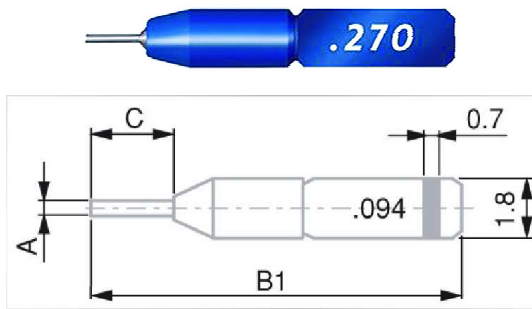

Ø A mm	B1 mm	C mm
0.050...0.109	10.3	0.8
0.110...0.159	10.5	1.0
0.060...0.209	10.7	1.4
0.210...0.309	11.1	1.6

MSA	Ø	Progression	Kg
15.032-x.xxx *	0.050...0.080 mm	0.002 mm (even sizes)	0.013
15.033-x.xxx *	0.051...0.079 mm	0.002 mm (uneven sizes)	0.013
15.034-x.xxx *	0.081...0.309 mm	0.002 mm (uneven sizes)	0.013
15.035-x.xxx *	0.082...0.308 mm	0.002 mm (even sizes)	0.013

CARY® steel plug gauge TDH type.
The most convenient and fastest method to check the small diameter holes. Because of their small size, it is necessary to use tweezers for their handling. Standard accuracy : ± 0.4 µm.

* Specify the exact diameter when ordering



MSA	Size	Kg
15.072	48 x 30 x 22 mm	0.022

Metal box for 10 CARY® plug gauges TDH type from Ø 0.050 to 0.309 mm.

CARY® steel plug gauges TLH type.

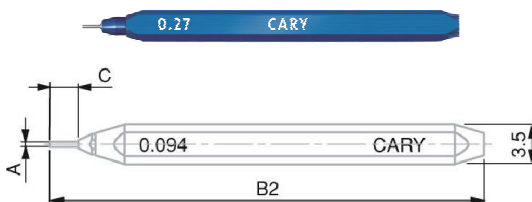

Ø A mm	B2 mm	C mm
0.050...0.109	31.8	0.8
0.110...0.159	32.0	1.0
0.060...0.209	32.2	1.4
0.210...0.309	32.6	1.6

MSA	Ø	Progression	Kg
15.021-x.xxx *	0.050...0.080 mm	0.002 mm (even sizes)	0.003
15.020-x.xxx *	0.051...0.079 mm	0.002 mm (uneven sizes)	0.003
15.022-x.xxx *	0.081...0.309 mm	0.002 mm (uneven sizes)	0.003
15.023-x.xxx *	0.082...0.308 mm	0.002 mm (even sizes)	0.003

CARY® steel plug gauge TLH type.
The TLH type is identical to the TDH type, but with a 30 mm-long handle. Standard accuracy : ± 0.4 µm.

* Specify the exact diameter when ordering



MSA	Size	Kg
15.068	80 x 82 x 47 mm	0.145

Wooden box for 25 CARY® plug gauges TLH type from Ø 0.050 to 0.309 mm.

Delivered without gauges.

CARY® steel simple plugs gauge TXH type.

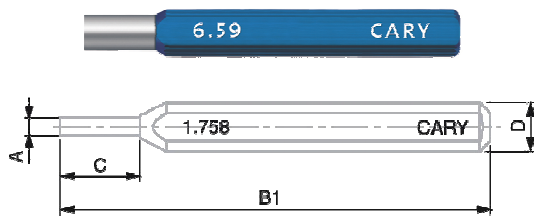

Ø A mm	B1 mm	C mm	D mm
0.300...0.509	38	3	3.5
0.510...1.009	39	4	3.5
1.010...1.509	40	5	3.5
1.510...2.009	46	6	5
2.010...2.509	47	7	5
2.510...3.009	48	8	5
3.010...3.509	49	9	5
3.510...4.009	60	10	8
4.010...5.009	61	11	8
5.010...10.010	62	12	8

MSA	Ø	Progression	Kg
15.026-x.xxx *	0.300...1.508 mm	0.002 mm (even sizes)	0.003
15.024-x.xxx *	0.301...1.509 mm	0.002 mm (uneven sizes)	0.003
15.029-x.xxx *	1.510...3.508 mm	0.002 mm (even sizes)	0.004
15.027-x.xxx *	1.511...3.509 mm	0.002 mm (uneven sizes)	0.004
15.031-x.xxx *	3.510...10.000 mm	0.002 mm (even sizes)	0.007
15.030-x.xxx *	3.511...9.999 mm	0.002 mm (uneven sizes)	0.007

CARY® steel simple plug gauge TXH type.

Standard accuracy from Ø 0.300 to 3.000 mm : ± 0.4 µm.

Standard accuracy from Ø 3.000 to 10.000 mm : ± 0.5 µm.

* Specify the exact diameter when ordering



MSA	Size	Kg
15.069 (1)	135 x 85 x 60 mm	0.240
15.070 (2)	135 x 85 x 60 mm	0.545

Wooden box for 50 CARY® plug gauges TLH type.

(1) from Ø 0.300 to 1.509 mm

(2) from Ø 1.510 to 3.509 mm

(1)

Sets of metric gauge steel blocks MITUTOYO®.
Delivered in a wooden box with a certificate of inspection.

How to choose the accuracy grade :

- Grade 1 : gauge blocks of this class are mainly used as working standards to set and calibrate plug gauges and measuring instruments in measuring rooms or inspection areas within the production.
- Grade 2 : these gauge blocks are commonly used as working standards in inspection rooms within the production to set and calibrate measuring instruments and other equipment as well as to inspect tools, fixtures and machines.

Mitutoyo



MSA	Number of blocks	Accuracy grade
15.630	32	1
15.631	32	2

Set of metric gauge steel blocks MITUTOYO®.

Composition :

Quantity and size :	Increment :
1x 1.005 mm	-
9x 1.01...1.09 mm	0.01 mm
9x 1.10...1.90 mm	0.10 mm
9x 1.00...9.00 mm	1.00 mm
3x 10...30 mm	10 mm
1x 60 mm	-

Mitutoyo



MSA	Number of blocks	Accuracy grade
15.632	47	1
15.633	47	2

Set of metric gauge steel blocks MITUTOYO®.

Composition :

Quantity and size :	Increment :
1x 1.005 mm	-
19x 1.01...1.19 mm	0.01 mm
8x 1.20...1.90 mm	0.10 mm
9x 1.00...9.00 mm	1.00 mm
10x 10...100 mm	10 mm

Mitutoyo



MSA	Number of blocks	Accuracy grade
15.634	87	1
15.635	87	2

Set of metric gauge steel blocks MITUTOYO®.

Composition :

Quantity and size :	Increment :
9x 1.001...1.009 mm	0.001 mm
49x 1.01...1.49 mm	0.01 mm
19x 0.50...9.50 mm	0.50 mm
10x 10...100 mm	10 mm

Calipers with vernier reading.

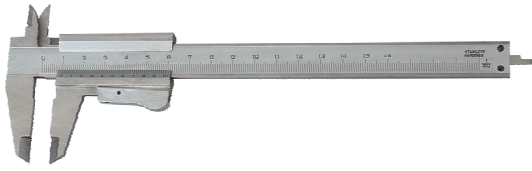

MSA	Measuring range	Precision	Kg
15.100	150 mm	0.02 mm	0.275

Hardened steel caliper with vernier reading.
Delivered in 1 imitation leather pouch.

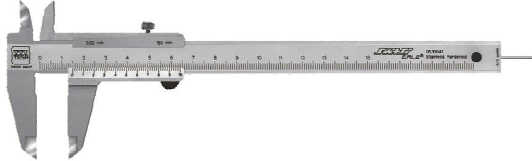

MSA	Measuring range	Precision	Kg
15.436	150 mm	0.02 mm	0.270

Hardened stainless steel standard caliper with vernier reading and locking screw.
Delivered in 1 synthetic case.

Dial calipers.

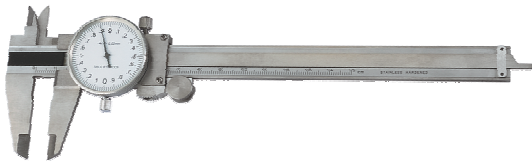

MSA	Measuring range	Precision	Kg
15.115	150 mm	0.02 mm	0.340

Hardened steel dial caliper. Rotating dial with locking screw.
Delivered in 1 synthetic case.

2 mm/revolution

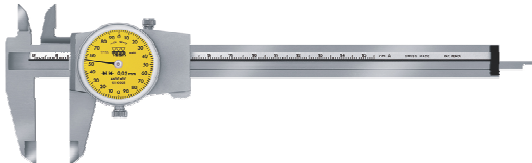

MSA	Measuring range	Precision	Kg
15.104	150 mm	0.02 mm	0.350

CCMA-M hardened stainless steel dial caliper (steel gear mechanism, hardened and ground).
- Easy-to-read
- Slider with metal dial housing
- Rotating dial Ø 32 mm with locking screw.
Delivered in 1 synthetic case.

2 mm/revolution

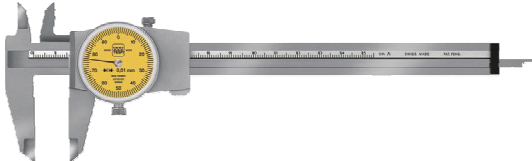

MSA	Measuring range	Precision	Kg
15.422	150 mm	0.01 mm	0.360

CCMA-M hardened stainless steel dial caliper (steel gear mechanism, hardened and ground).
- Easy-to-read
- Slider with metal dial housing
- Rotating dial Ø 32 mm with locking screw.
Delivered in 1 synthetic case.

1 mm/revolution

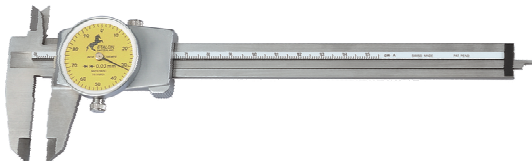

MSA	Measuring range	Precision	Kg
15.110	150 mm	0.02 mm	0.370

ETALON 125 hardened stainless steel dial caliper (steel gear mechanism, hardened and ground).
- Slider with metal dial housing
- Rotating dial Ø 32 mm with locking screw.
Delivered in 1 synthetic case.

1 mm/revolution

Electronic calipers.



MSA	Measuring range	Precision	Kg
15.512	100 mm / 4"	0.01 mm / 0.0005"	0.170

Small hardened steel electronic caliper, very practical thanks to its reduced dimensions.

Delivered in 1 synthetic case.



MSA	Measuring range	Precision	Kg
15.510	150 mm / 6"	0.01 mm / 0.0005"	0.100

Synthetic electronic caliper.

Delivered in 1 transparent plastic case.



MSA	Measuring range	Precision	Kg
15.511	150 mm / 6"	0.01 mm / 0.0005"	0.325

Tempered steel electronic caliper.

Delivered in 1 synthetic case.

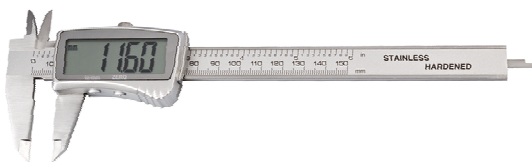

MSA	Measuring range	Precision	Kg
15.513	150 mm / 6"	0.01 mm / 0.005"	0.292

Hardened steel electronic caliper.

Big LCD display 15 mm.

Delivered in 1 synthetic case.

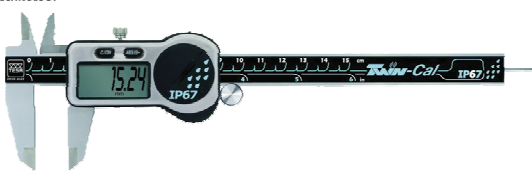

MSA	Measuring range	Precision	Kg
15.107	150 mm / 6"	0.01 mm / 0.005"	0.150
15.457	150 mm / 6"	0.01 mm / 0.005"	0.150
15.113	150 mm / 6"	0.01 mm / 0.005"	0.150
15.458	200 mm / 8"	0.01 mm / 0.005"	0.200
15.459	300 mm / 12"	0.01 mm / 0.005"	0.280

TWIN-CAL electronic caliper with the highest degree of protection ever reached. Resists to any penetration of liquids and particles of materials (metal or other).

- Degree of protection IP67
- Square depth rod : MSA15.107, MSA15.458 and MSA15.459
- Round depth rod : MSA15.457
- Round depth rod with thumb roller : MSA15.113
- The inductive measuring system, a TESA technology, guarantees reliability and high precision even in harsh conditions
- Equipped with TLC (TESA Link Connector), the unique integral data output facility, providing the opportunity to upgrade your caliper at any time
- LCD display, 11 mm
- Lithium battery 3 V, CR 2032.

Delivered in 1 synthetic case.

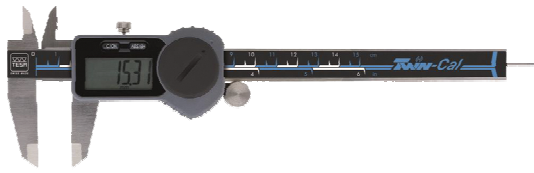

MSA	Measuring range	Precision	Kg
15.111	150 mm / 6"	0.01 mm / 0.0005"	0.150
15.112	150 mm / 6"	0.01 mm / 0.0005"	0.150
15.108	200 mm / 8"	0.01 mm / 0.0005"	0.150

TWIN-CAL electronic caliper. High degree of protection against dust.

- Degree of protection IP40
- Rectangular depth rod (MSA15.111 and MSA15.108, the latter with thumb roller) or round (MSA15.112 with thumb roller)
- Equipped with an integrated data output. Simply connect the TWIN-CAL via the TLC (TESA Link Connector) to a PC and all your measurement results will be captured and stored for optimal SPC monitoring
- LCD display, 11 mm
- Lithium battery 3 V, CR 2032.

Delivered in 1 synthetic case.

Data transfer.



(1)



(2)

MSA		Model	Length	Kg
15.114	(1)	Opto-USB	2 m	0.045
15.117	(2)	Opto-Sub-D	2 m	0.040

Duplex connecting cable, bidirectional communication. Any connecting cable is defined by each of the connectors fitted at either end of the cable principally to suit the computer, and the measuring instrument being used. To achieve highest compatibility levels, TESA® uses only standardized and proven connectors.

MSA15.114 :

- Opto RS232 connector (for instrument)
- USB connector A type (for computer or system).

MSA15.117 :

- Opto RS232 connector (for instrument)
- Connector Sub-D 9 p/f Duplex (for computer or system).



MSA	Length	Kg
15.469	2 m	0.055

TLC-USB cable for instrument with TLC connector (TESA Link Connector).

- TLC connector (for instrument)
- USB connector (for computer or system).



(1)

(2)

MSA		Kg
15.524	(1)	0.100
15.523	(2)	0.150

USB accessory.

(1) Multiplexer, 7 USB ports 2.0.

- Robust steel housing
- External powering using a C-type AUX connector, 4 pins
- Delivered with : DC mains adapter (EU) and connecting cable to PC
- Recommended highest number of ports : 49 USB ports connectable on 2 levels.

(2) USB foot switch.

- Direct connection to any USB port
- Takes DataDirect or StatExpress into account when transferring the measured values from all connected measuring tools.

Wireless data transfer.



MSA		Kg
15.624		0.088

The Bluetooth® TLC-BLE emitter is adaptable to a very wide range of instruments to transfer data easily.

The Bluetooth® wireless transmitter allows to send the measured values of most TESA instruments to a computer. This wireless data transfer avoids transcription errors and improves the traceability. The emitters are quickly adaptable to all TLC connectors (TESA Link Connector) to upgrade both new and existing models.

Delivered with 1 emitter, 1 USB Dongle receiver and 1 extension cable 1.5 m.



MSA		Kg
15.625		

Bluetooth® TLC-BLE emitter.



MSA		Kg
15.626		

Adapter type OPTO-RS232/TLC with Velcro® strap for fixing the emitter.



Date	Instrument	Measure	Date	Time
17.03.2020	OPTO-USB - cat P-B7	1.840	21.01.2010	12:08:06
	USB Probe ST21	-1.033	21.01.2010	12:08:06
	OPTO-USB - cat P-B7	1.840	21.01.2010	12:08:07
	USB Probe ST21	-1.033	21.01.2010	12:08:07
	OPTO-USB - cat P-B7	1.840	21.01.2010	12:08:07
	USB Probe ST21	-1.033	21.01.2010	12:08:07
	OPTO-USB - cat P-B7	1.840	21.01.2010	12:08:08
	USB Probe ST21	-1.032	21.01.2010	12:08:08
	OPTO-USB - cat P-B7	1.840	21.01.2010	12:08:10
	USB Probe ST21	-1.033	21.01.2010	12:08:10
	OPTO-USB - cat P-B7	1.840	21.01.2010	12:08:12
	USB Probe ST21	-1.033	21.01.2010	12:08:12
	OPTO-USB - cat P-B7	1.840	21.01.2010	12:08:13
	USB Probe ST21	-1.033	21.01.2010	12:08:13
	OPTO-USB - cat P-B7	1.840	21.01.2010	12:08:16
	USB Probe ST21	-1.032	21.01.2010	12:08:16

MSA		Kg
15.522		0.110

Software DATA-DIRECT + dongle.

DATA-DIRECT software is an easy way to collect and report results in real time from the majority of the measuring instruments in the TESA range that have an RS232 output.

DATA-DIRECT is supplied not only with serial input/output drivers specially configured for TESA's products, but also for those purchased from other manufacturers. It works effectively to give data transfer for your data sheets, database, statistical modules or any other Windows-based applications.

- TESA® DATA-DIRECT installation CD + USB license key + user instructions (PDF version).

Printer.



MSA	Size	Kg
15.479	180 x 180 x 84 mm	0.550

PRINTER SPC portable printer.

- Intelligent printer designed for the inspection of finished parts or incoming goods
- Value classification
- Prints out measurement results with graphical representations
- 5 languages : French, German, English, Italian and Spanish
- Can be connected not only to TESA measuring instruments, but also to those provided with a DIGIMATIC output
- The printer is capable of recognising the connected tool and will execute the appropriate configuration automatically
- Adapter 100-240 V AC, 6.6 V DC
- Roll width : 110 mm
- Printing : 40 signs/line.

Spare part :

MSA	Item	Kg
15.480	Paper roll, width 110 mm	0.190

Boxes of instruments TESA®.



MSA	Kg
15.730	0.498

TESA® analogue measuring instruments box CS6 for apprentices, composed of :

- Dial caliper, with measuring range 150 mm, precision 0.02 mm
- Analogue micrometre, with measuring range from 0 to 25 mm, precision 0.01 mm
- Steel bevelled edge square, 100 x 70 mm
- Flexible rule 150 mm.

Delivered in 1 synthetic case.



MSA	Kg
15.731	0.469

TESA® digital measuring instruments box CS13 for apprentices, composed of :

- Electronic caliper (Protection IP67), with measuring range 150 mm, precision 0.01 mm
- Electronic micrometre, with measuring range from 0 to 30 mm, precision 0.001 mm
- Depth measuring foot.

Delivered in 1 synthetic case.

 sylvac



MSA

15.179

SYLVAC® digital measuring instruments box for apprentices, composed of :

- Electronic caliper 150 mm, precision 0.01 mm (Protection IP67)
- Electronic micrometre 0-30 mm
- Flexible rule 150 mm
- Precision square
- 1 thread gauge + 1 radius gauge
- Scriber 180 mm.

Delivered in 1 synthetic case.

Lever indicators GIROD-TAST.

- High sensitivity, repeatability and accuracy (according to DIN 2270 standards). Unaffected by magnetic fields
- Automatic reversing contact point, with constant clockwise rotation
- Easy and error-free reading by only one revolution of the hand
- Robust one-piece housing ; corrosion resistant with satin chrome finish
- Designed for universal applications. Well-suited for workshop use.
- Interchangeable carbide contact point swivels over 240°.

 GIROD INSTRUMENTS

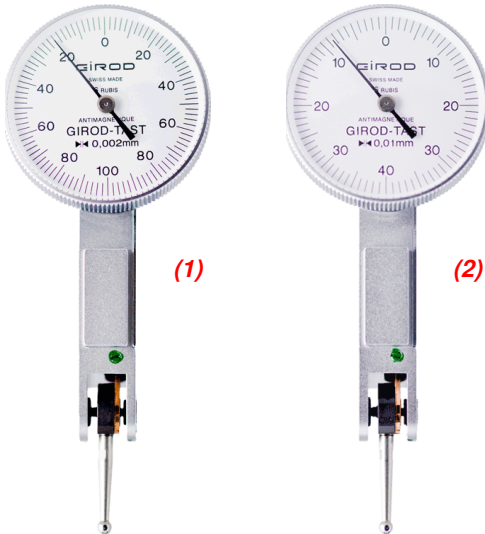

MSA		Measuring range	Precision	Ø dial	Circular scale
15.131	(1)	0.20 mm	0.002 mm	28 mm	0 - 100 - 0 mm
15.611		0.20 mm	0.002 mm	37 mm	0 - 100 - 0 mm
-		-	-	-	-
15.132	(2)	0.80 mm	0.01 mm	28 mm	0 - 40 - 0 mm
15.125		0.80 mm	0.01 mm	37 mm	0 - 40 - 0 mm

TESATAST standard lever indicator.

 GIROD INSTRUMENTS



MSA	Measuring range	Precision	Ø dial	Circular scale
15.133	0.80 mm	0.01 mm	28 mm	0 - 40 - 0 mm

TESATAST standard lever indicator.

Longitudinal lever

Electronic indicators.

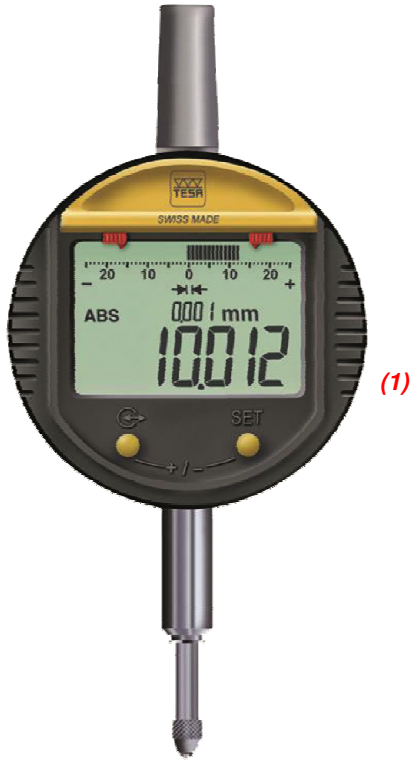

MSA	Model	Measuring range	Resolution	Kg
15.453	205 MI	12.50 mm / 0.5"	0.01 mm / 0.0005"	0.150
15.445	(1) 305 MI	12.50 mm / 0.5"	0.001 mm / 0.00005"	0.150

DIGICO electronic indicator.

- Maximum permissible errors/Limit deviations : 20 µm (MSA15.453) or 8 µm (MSA15.445)
- Measuring force : ≤ 2 N
- Dual LCD display, numerical and analogue
- Digit size 10 x 5 mm (H x L)
- Mechanical tolerance marks.

Principal functions :

- ON/Auto OFF
- Data output
- Counting sense reversal
- Keypad lock
- Lithium battery 3 V, CR 2032.

Travel 12.50 mm / 0.5"



MSA	Model	Measuring range	Resolution	Kg
15.449	505 MIE	12.50 mm / 0.5"	0.001 mm / 0.00005"	0.150

DIGICO electronic indicator.

- Maximum permissible errors/Limit deviations : 4 µm
- Measuring force : < 2 N
- Measuring modes ABS/REL
- Dual LCD display, numerical and analogue
- Digit size 10 x 5 mm (H x L)
- Display rotation through 270°. Same goes for the key functions
- Mechanical tolerance marks
- Graphic display of tolerances.

Principal functions :

- ON/Auto OFF
- PRESET mode
- Tolerance mode
- Data output
- Counting sense reversal
- Keypad lock
- Metric/Inch units
- Full RESET
- Lithium battery 3 V, CR 2032.

Travel 12.50 mm / 0.5"



Travel 12.50 mm / 0.5"

MSA	Model	Measuring range	Resolution	Kg
15.437	705 MI	12.50 mm / 0.5"	0.001 mm / 0.00005"	0.150

DIGICO electronic indicator.

- Maximum permissible errors/Limit deviations : 4 µm
- Measuring force : < 2 N
- Use in conjunction with bore gauges with 2-point contact. Allows setting of the dial gauge on the smallest setting ring value.

Principal functions :

- ON/Auto OFF
- PRESET mode
- Tolerance mode
- Value storage mode : Max, Min and Max-Min (TIR)
- Data output
- Counting sense reversal
- Keypad lock
- Metric/Inch units
- Full RESET
- Lithium battery 3 V, CR 2032.



Travel 25 mm / 1"

MSA	Model	Measuring range	Resolution	Kg
15.450	610 MI	25.00 mm / 1"	0.001 mm / 0.00005"	0.162

DIGICO electronic indicator.

- Maximum permissible errors/Limit deviations : 5 µm
- Measuring force : < 2 N
- Measuring modes ABS/REL
- Dual LCD display, numerical and analogue
- Digit size 10 x 5 mm (H X L)
- Display rotation through 270°. Same goes for the key functions
- Mechanical tolerance marks
- Graphic display of tolerances.

Principal functions :

- ON/Auto OFF
- PRESET mode
- Tolerance mode
- Value storage mode : Max, Min and Max-Min (TIR)
- Data output
- Counting sense reversal
- Keypad lock
- Metric/Inch units
- Full RESET
- Lithium battery 3 V, CR 2032.

SWISSMETROLOGIE



MSA	Measuring range	Resolution	Kg
15.454-25	25.00 mm / 1"	0.001 mm / 0.00005"	0.390
15.454-50	50.00 mm / 2"	0.001 mm / 0.00005"	0.490

SWISSMETROLOGIE® electronic indicator.

- Maximum permissible errors/Limit deviations :
 - MSA15.454-10 = 0.004 mm
 - MSA15.454-25 = 0.005 mm
 - MSA15.454-50 = 0.006 mm
- Mounting rod Ø 8 mm
- LCD display 10.5 mm
- PRESET and ON/OFF functions
- Measuring modes ABS/DIFF
- Lithium battery 3 V, CR 2032.

Delivered in 1 synthetic case with operating instructions.

Travel 10, 25 or 50 mm / 0.4, 1 or 2"



MSA	Measuring range	Resolution	Kg
15.128	12.50 mm / 0.5"	0.001 mm / 0.00005"	0.247

STANDARD GAGE® electronic indicator.

- Maximum permissible error : 0.004 mm
- Repeatability : 0.002 mm
- Mounting rod Ø 8 mm
- LCD display 10.5 mm
- ABS/PRESET, metric/inch, TOL/SETTOL, MAX/MIN and ZERO/ON buttons
- Lithium battery 3 V, CR 2032.

Delivered in 1 synthetic case with operating instructions.

Travel 12.50 mm / 0.5"



MSA	Measuring range	Resolution	Total length
15.160	25.00 mm 1"	0.0001 mm 0.000004"	Avec With Mit Co
15.161	25.00 mm 1"	0.0001 mm 0.000004"	Sans Without Ohr
-	-	-	-
15.162	50.00 mm 2"	0.0001 mm 0.000004"	Avec With Mit Co
15.163	50.00 mm 2"	0.0001 mm 0.000004"	Sans Without Ohr

SYLVAC® S-DIAL PRO SMART electronic indicator.

- Maximum error : 1 µm
- Repeatability : 0.2 µm
- Mounting rod Ø 8 mm
- Large display with tolerance status indication by colour LED
- Output data : USB - RS232 - Bluetooth
- Three buttons, including the central button with selectable favourite function
- Wide range of functions, including MIN/MAX/DELTA
- Protection class IP51.

Travel 25 or 50 mm / 1 or 2"

Analogic dial gauges.



MSA	Measuring range	Precision	Kg
15.399	10 mm	0.01 mm	0.170

JFK FEINTASTER dial gauge on horizontal support with "Z" adjustable table.



MSA	Measuring range	Precision	Ø dial	Kg
15.126	10 mm	0.01 mm	57 mm	0.170

Analogical dial gauge MITUTOYO®.

- Circular scale : 0 - 100
- 1 dial revolution : 1 mm
- Fixing Ø 8 mm
- Carbide insert.

Cylindrical measuring inserts for indicators.

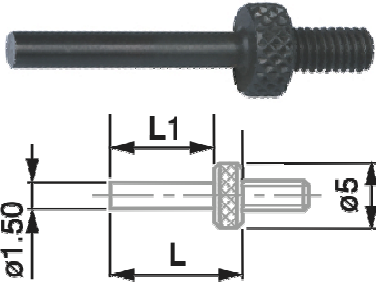

Steel

MSA	Ø	Useful length	Kg
15.477	2.00 mm	5.00 mm	0.001
15.417	2.00 mm	10.00 mm	0.001
15.416	2.00 mm	15.00 mm	0.001

Steel cylindrical measuring insert with flat measuring face, M2.5.

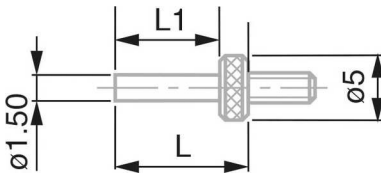

Steel

MSA	Ø	Useful length	Kg
15.650	1.50 mm	15.00 mm	0.004
15.651	1.50 mm	20.00 mm	0.004
15.652	1.50 mm	25.00 mm	0.004
15.653	1.50 mm	30.00 mm	0.004

Steel cylindrical measuring insert with flat measuring face, M2.5.

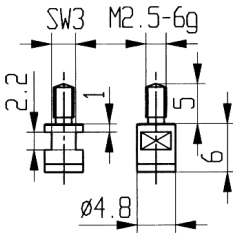

Carbide

MSA	Ø	Useful length	Kg
15.654	4.80 mm	6.00 mm	0.004

Carbide cylindrical measuring insert with flat measuring face, M2.5.

Special measuring inserts for indicators.

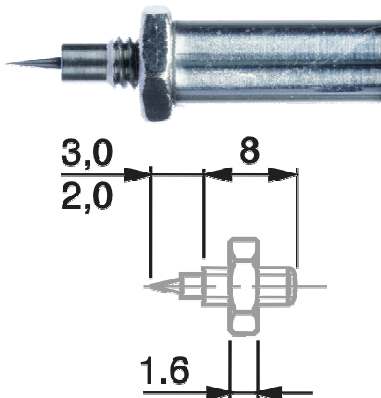

Steel

MSA
15.448

Steel measuring insert with needle contact point, M2.5.

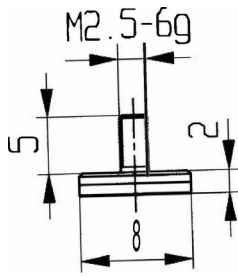

Steel

MSA	Ø	Thickness	Useful length	Kg
15.657-08	8.00 mm	2.00 mm	7.00 mm	0.010
15.657-10	10.00 mm	2.00 mm	7.00 mm	0.010
15.657-12	12.00 mm	2.00 mm	7.00 mm	0.010
15.657-15	15.00 mm	2.00 mm	7.00 mm	0.010
15.657-20	20.00 mm	2.00 mm	7.00 mm	0.010
15.657-25	25.00 mm	2.00 mm	7.00 mm	0.010

Steel measuring insert plate-shaped, M2.5.

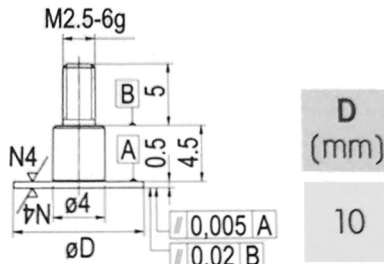

Steel

MSA	Ø	Thickness	Kg
15.668	10.00 mm	0.50 mm	0.002

Steel measuring insert plate-shaped, M2.5.

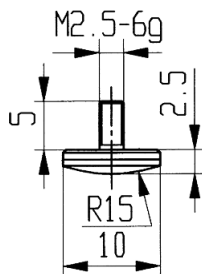

Carbide

MSA	Ø	Thickness	Useful length	Kg
15.658	10.00 mm	2.50 mm	7.50 mm	0.002

Carbide domed measuring insert, M2.5.

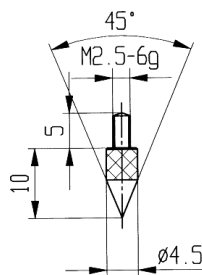

Carbide

MSA	Ø	Useful length	Kg
15.659	4.50 mm	10.00 mm	0.002

Carbide conical 45° measuring insert, M2.5.

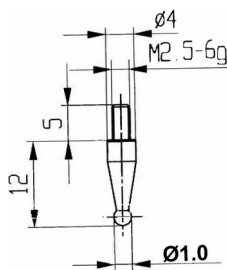

Carbide

MSA	Ø	Useful length	Kg
15.660-1.00	1.00 mm	12.00 mm	0.004
15.660-2.00	2.00 mm	12.00 mm	0.004
15.660-3.00	3.00 mm	12.00 mm	0.004

Carbide ball tip measuring insert, M2.5.

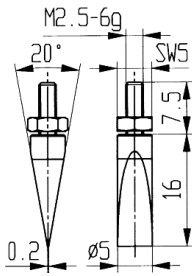

Carbide

MSA	Ø	Useful length	Kg
15.661	5.00 mm	16.00 mm	0.005

Carbide knife-shaped 20° measuring insert, M2.5.

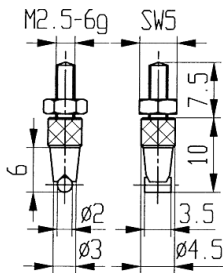

Carbide

MSA	Ø	Useful length	Width	Kg
15.662	2.00 mm	10.00 mm	3.50 mm	0.005

Carbide over wire measuring insert, M2.5.

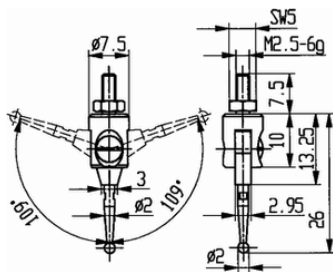

Carbide

MSA	Ø	Useful length	Kg
15.663	2.00 mm	26 mm	0.005

Carbide ball tip measuring insert on articulated pivot, M2.5.

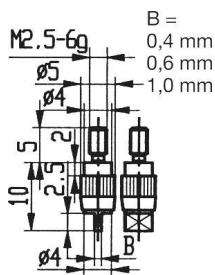

Carbide

MSA	Thickness	Useful length	Width	Kg
15.664	0.40 mm	2.50 mm	2.00 mm	0.005
15.665	0.60 mm	2.50 mm	2.00 mm	0.005
15.666	1.00 mm	2.50 mm	4.00 mm	0.005

Carbide knife-shaped measuring insert, M2.5.

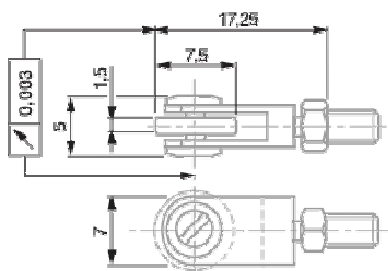

Steel

MSA	Ø	Useful length	Kg
15.667	7.00 mm	17.25 mm	0.005

Steel measuring insert with ball-bearing rollers.

Adapter for vertical dial indicators.

SWISSMETROLOGIE



MSA	Size	Kg
15.380	Ø 8 x 35 mm	0.010

Adapter for mounting on a vertical dial indicator. To be used with a plug gauge.

Adapter for interchangeable cylindrical measuring inserts for indicators.

SWISSMETROLOGIE

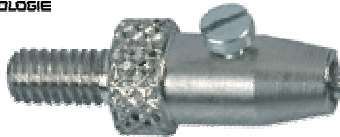

MSA	Kg
15.373	0.002

Adapter for steel interchangeable cylindrical measuring inserts, clamping shank Ø 1.50 mm with tightening screw.

Interchangeable measuring inserts for indicators.

SWISSMETROLOGIE



Carbide

MSA	Ø	Useful length	Total length	Kg
15.358-0.20	0.20 mm	4 mm	16 mm	0.001
15.358-0.30	0.30 mm	4 mm	16 mm	0.001
15.358-0.40	0.40 mm	4 mm	16 mm	0.001
15.358-0.50	0.50 mm	4 mm	16 mm	0.001
15.358-0.80	0.80 mm	6 mm	16 mm	0.001
15.358-1.00	1.00 mm	6 mm	16 mm	0.001
15.358-1.20	1.20 mm	6 mm	16 mm	0.001
15.358-1.50	1.50 mm	16 mm	16 mm	0.001
15.358-2.00	2.00 mm	10 mm	16 mm	0.001

Carbide interchangeable cylindrical measuring insert with flat measuring face.

SWISSMETROLOGIE

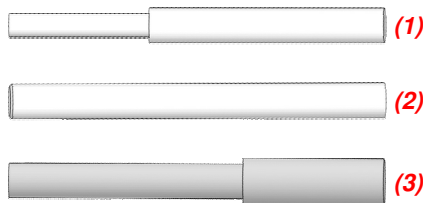

PEEK

MSA	Ø	Useful length	Total length	Kg
15.357-1.00 (1)	1.00 mm	10 mm	16 mm	0.001
15.357-1.50 (2)	1.50 mm	16 mm	16 mm	0.001
15.357-2.00 (3)	2.00 mm	6 mm	16 mm	0.001

PEEK interchangeable cylindrical measuring insert with flat measuring face.

Extensions for measuring inserts.

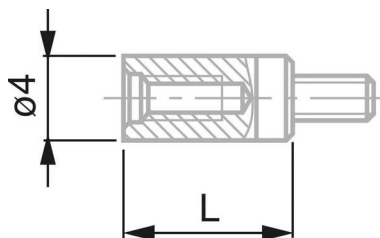

MSA	Ø	Length	Kg
15.359-07	4.00 mm	7 mm	0.001
15.359-10	4.00 mm	10 mm	0.002
15.359-15	4.00 mm	15 mm	0.002
15.359-20	4.00 mm	20 mm	0.003
15.359-25	4.00 mm	25 mm	0.004
15.359-30	4.00 mm	30 mm	0.004
15.359-40	4.00 mm	40 mm	0.005
15.359-50	4.00 mm	50 mm	0.006

Extension for measuring inserts, M2.5.

Retraction devices.



MSA	Ø	Kg
15.409	58 mm	0.008

Device for plunger retraction for mounting on the top stem.

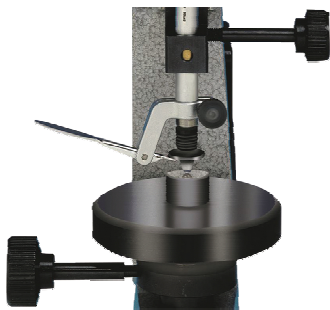

MSA
15.446

Device for plunger retraction for mounting on the bottom stem.
Delivered with a lift lever and a washer.



MSA
15.478

Bottom mounted lift lever.
Contains only the retraction lever.



MSA	Kg
15.407-B	0.010

Top lever for plunger retraction.

Vertical measuring supports.

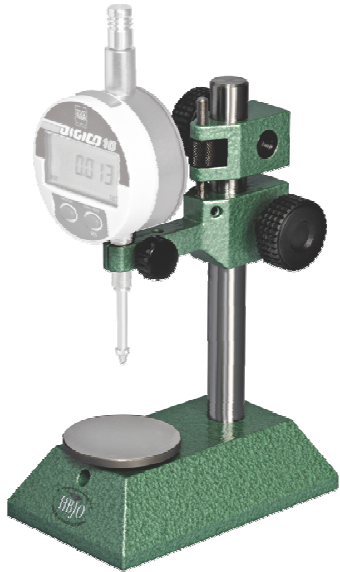

MSA	Ø table	Size	Kg
15.360	50 mm	80 x 130 x 255 mm	2.500
15.361	80 mm	80 x 130 x 255 mm	2.530

Vertical support V 01 type with steel base.
 Measuring capacity 75 mm.
 Delivered with measuring instrument.

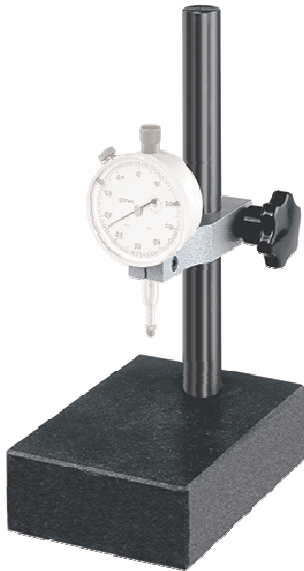

MSA	Kg
15.424	2.600

INTERAPID table measuring stand with granite base, grade 00.
 - Measuring range 0 - 170 mm
 - Chrome-plated column Ø 20 mm, tightening Ø 8 mm
 - Measuring table 100 x 150 x 40 mm.
 Delivered without measuring instrument.

Other sizes on request.



MSA	Kg
15.424-B	4.920

Vertical table measuring stand with granite base.
 - Measuring range 0 - 250 mm
 - Chrome-plated column Ø 25 mm, tightening Ø 8 mm
 - Measuring table 150 x 200 x 40 mm.

Other sizes on request.

SWISSMETROLOGIE



Ceramic

MSA	Size	Kg
15.549	150 x 100 x 40 mm	2.000
15.548	200 x 150 x 40 mm	3.000

Measuring stand with ceramic base.
 - Column height 250 mm
 - Arm length 65 mm.

SWISSMETROLOGIE

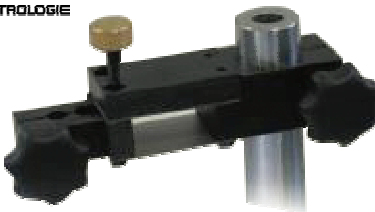

MSA	Kg
15.558	0.200

Arm with fine setting for measuring stands MSA15.548 and MSA15.549.
 - Centre distance arm 79 mm.

Measuring probes.

HEIDENHAIN



MSA	Model	Measuring travel	Kg
15.547	MT 1281	12 mm	0.550
15.585	MT 2581	25 mm	0.700

METRO high-precision incremental probe.
 Suitable for measuring stations and control equipments where the precision is important.
 The guided ball-bearing measuring stem allows the absorbing of high transverse loads.
 - Measuring range up to 25 mm
 - Division 4 µm
 - Sinusoidal alternation of amplitude 1 Vcc, signal 2 µm
 - System accuracy ± 0,2 µm
 - Tightening stem Ø 8 mm
 - Interchangeable measuring insert M2.5
 - Cable length 1.5 m
 - Plug connector Sub-D with 15 poles.

Travel 12 or 25 mm



Travel 30 mm

MSA	Model	Measuring travel	Kg
15.586	ST 3088	30 mm	0.500

SPECTO high-precision incremental probe. Suitable essentially for multi-measurements working stations and control equipments, thanks to its particularly compact design.

- Measuring range up to 30 mm
- Division 20 µm
- Sinusoidal alternation of amplitude 1 Vcc, signal 20 µm
- System accuracy ± 1 µm
- Tightening stem Ø 8 mm
- interchangeable measuring insert M2.5
- Axial cable length 1.5 m
- Plug connector Sub-D with 15 poles.

Display units.



MSA	Model	Kg
15.546	M3	0.750

Digital display unit for probe with 2 sensor inputs. Last generation tool to perform dimensional controls from 1 or 2 probes. Equipped with a 4.3" colour touch screen, which allows an easy configuration thanks to the drop down menus, the icons and the functions buttons

- Has different means of communication (USB or RS 232) to transmit measurements to a PC or control the display remotely.

Key features :

- 2 configurations of measurement (2 sides)
- Absolute or relative measurements
- Compatible with inductive and incremental probes
- ASCII communication on Modbus RTU
- Keyboard USB function when the display unit is connected to a PC
- Automatic change of configuration of measurement by probe movement
- Safe and easy to use.

Additional features :

- Different display modes with 1 or 2 sides per screen, with or without tolerances
- Static and dynamic measurement (Min, Max, Max-Min, Average, Median)
- Control limits
- Sorted by grades (up to 16 grades)
- Connection of an optional box with 8 opto-coupled inputs/outputs (MB-IO).

Analogical vertical external micrometres.



MSA	Size	Kg
15.302	85 x 100 x 160 mm	2.800

Vertical micrometre 0-25 mm with table Ø 50 mm. Micrometric touch adjuster with non-revolving spindle.

- Measuring range 0 - 25 mm
- Precision 0.01 mm.



MSA	Size	Kg
15.303	80 x 130 x 220 mm	2.800

Vertical support V 012 type with perforated table.
 - Measuring capacity 65 mm
 - Micrometric touch adjuster measuring capacity 0 - 25 mm
 - Precision 0.01 mm.

Accessories for analogical vertical external micrometres.

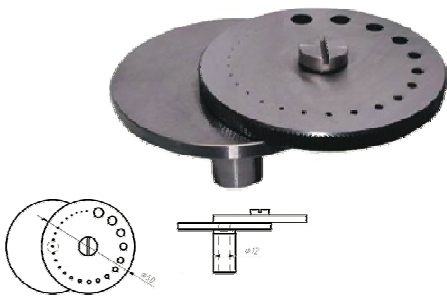

MSA	Ø
15.369	50 mm

Complete table with 25 holes Ø 0.20 - 5.00 mm.

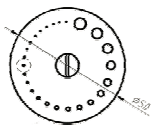
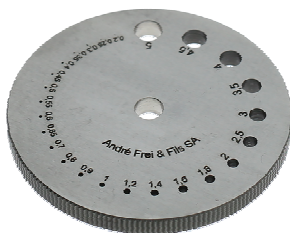

MSA	Model	Size	Kg
15.370	(1) With engraving	Ø 50 mm	0.060
15.370-A	Without engraving	Ø 50 mm	0.060

Support with 25 holes Ø 0.20 - 5.00 mm.

- Ø 0.20, 0.25, 0.30, 0.35, 0.40, 0.45, 0.50, 0.55, 0.60, 0.65, 0.70, 0.80, 0.90, 1.00, 1.20, 1.40, 1.60, 1.80, 2.00, 2.50, 3.00, 3.50, 4.00, 4.50 and 5.00 mm.

Analogical horizontal external micrometre.

Mitutoyo

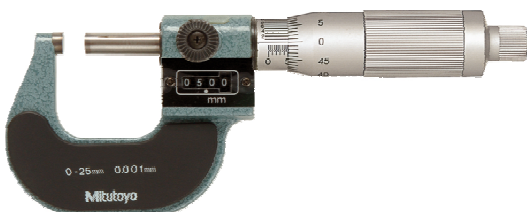

MSA	Measuring range	Precision	Kg
15.129	0 - 25 mm	0.001 mm	0.224

Analogical horizontal external counter micrometre MITUTOYO®.
 - Measuring force 5 - 15 N
 - Maximum permissible errors : ± 2 µm
 - Measuring face : Ø 6.50 mm.

Electronic horizontal external micrometres.



(1)

MSA	Measuring range	Degree of protection	Kg
15.431	0 - 30 mm / 0 - 1.2"	IP 40	0.440
15.426	(1) 0 - 30 mm / 0 - 1.2"	IP 54	0.440

MICROMASTER electronic external micrometre.

- Precision 0.001 mm or 0.00005"
 - Maximum measuring force 10 N
 - Measuring face Ø 6.50 mm
 - Large easy-to-read LCD display, digit height 7 mm
 - Lithium battery 3 V, CR 2032 - RS 232 interface, opto-coupled.
- Delivered in 1 synthetic case.



MSA	Measuring range	Degree of protection	Kg
15.484	0 - 30 mm / 0 - 1.2"	IP 54	0.440

MICROMASTER electronic external micrometre with small measuring faces. For measuring grooves, feather grooves, splines and other difficult-to-reach locations. Small measuring faces specially made to check small precision workpieces.

- Precision 0.001 mm or 0.00005"
 - Maximum measuring force 10 N
 - Measuring face Ø 2 mm, length 5 mm
 - Large easy-to-read LCD display, digit height 7 mm
 - Lithium battery 3 V, CR 2032 - RS 232 interface, opto-coupled.
- Delivered in 1 synthetic case.

Micrometre support.



MSA
15.452

Stand for external micrometres up to 300 mm as well as many other hand-held tools.

- Tilt can be locked using a single bolt
- Lacquered cast iron base
- Clamp opening : 16 mm.

Analogue horizontal table micrometre.

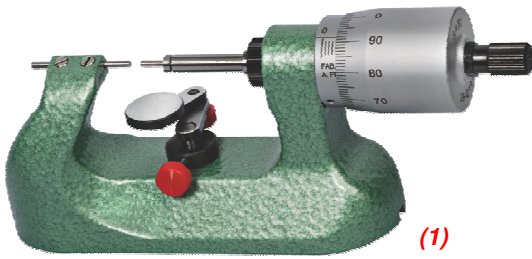

MSA	Insert	Table	Size	Kg
15.310	A Ø 2 mm	-	160 x 40 x 65 mm	1.000
15.311	(1) S-A Ø 2 mm	Yes	160 x 40 x 65 mm	0.940

Horizontal micrometre 0 - 25 mm.

Other cylindrical inserts on request.

Electronic horizontal table micrometre.



MSA	Size
15.301	215 x 40 x 70 mm

Horizontal micrometre 0 - 25 mm with universal table. Digital stop with non-rotating spindle.

- Precision 0.001 mm or 0.00005"
- LCD display large format, digit height 7 mm
- RS 232 output.

Delivered without inserts.

Accessories for horizontal table micrometres.



MSA	Ø	Kg
15.371	17 mm	0.080

Universal table for horizontal micrometres.

Measuring "C" benches.

SWISSMETROLOGIE



MSA	Kg
15.567	1.800

Reclining measuring "C" bench (use with inserts M2.5).

- Measuring capacity 30 mm
- Travel 12 mm
- Measuring force from 0.3 to 1 N
- Lift lever.

Delivered without measuring inserts.

SWISSMETROLOGIE



MSA	Insert thickness	Insert useful length	Kg
15.560	1 mm	> 10 mm	1.800
15.561	1.5 mm	> 10 mm	1.800
15.562	2 mm	> 10 mm	1.800
15.563	3 mm	> 10 mm	1.800
15.564	4 mm	> 10 mm	1.800
15.565	5 mm	> 10 mm	1.800
15.566	6 mm	> 10 mm	1.800

Reclining measuring "C" bench with hard metal cylindrical fixed measuring inserts.

- Measuring capacity 30 mm
- Travel 12 mm
- Flatness inserts 0.3 µm maximum
- Parallelism inserts < 1 µm maximum
- Measuring force from 0.3 to 1 N
- Lift lever.

SWISSMETROLOGIE



MSA	Insert thickness	Insert useful length	Kg
15.532	0.2 mm	< 5 mm	1.920
15.533	0.3 mm	< 5 mm	1.920
15.534	0.4 mm	< 5 mm	1.920
15.531	0.5 mm	< 5 mm	1.920

Reclining measuring "C" bench with hard metal fixed knife-shaped measuring inserts.

- Measuring capacity 30 mm
- Travel 12 mm
- Flatness inserts 0.3 µm maximum
- Parallelism inserts < 1 µm maximum
- Measuring force from 0.3 to 1 N
- Lift lever.

Horizontal measuring bench for external measurements, can be used with interchangeable measuring inserts CARY® type.

SWISSMETROLOGIE



MONO-BLOCK STRUCTURE

MSA	Kg
15.559	2.100

- SWISSMETROLOGIE® horizontal measuring bench.
- Measuring capacity 30 mm
 - Travel 12 mm
 - Flatness inserts 0.3 µm maximum
 - Parallelism inserts < 1 µm maximum
 - Measuring force from 0.3 to 1 N
 - Lift lever.
- Delivered without measuring inserts.*

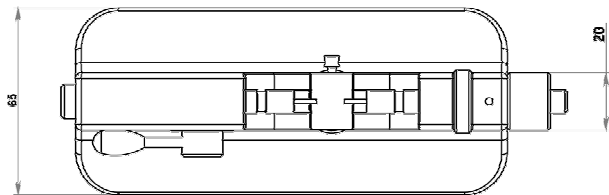
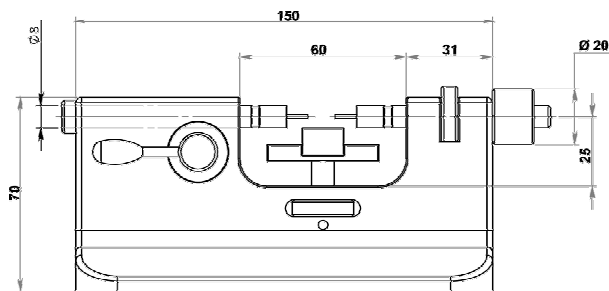
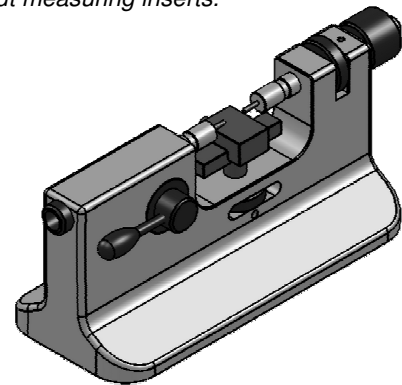

Interchangeable measuring inserts CARY® type.



MSA	Thickness	Useful length	Width
15.550	0.2 mm	< 5 mm	3.50 mm
15.551	0.3 mm	< 5 mm	3.50 mm
15.552	0.4 mm	< 5 mm	3.50 mm
15.553	0.5 mm	< 5 mm	3.50 mm

Pair of carbide knife-shaped measuring inserts, for MSA15.494 and MSA15.559.

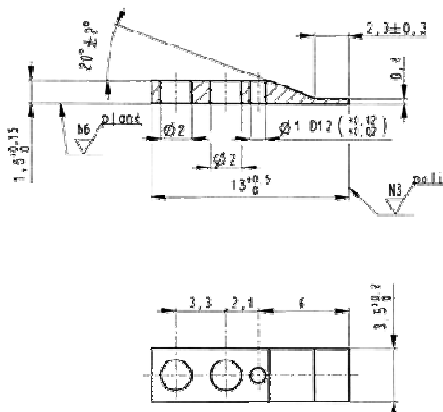

Horizontal measuring bench for EXTERNAL measurements, can be used with interchangeable measuring inserts SYLVAC® and CARY® types.

 sylvac



MSA	Measuring range	Resolution	Kg
15.170	0 - 25 mm	0.0001 mm	3.600

SYLVAC® PS16 V2 horizontal measuring bench for external measurements.

- Robust cast iron construction
- With integrated Bluetooth system
- Large display with tolerance status indication by colour LED
- Three buttons, including the central button with selectable favourite function
- Adjustable measuring force 0.1 - 0.6 N
- Protection class IP67.

Delivered with 2 hard metal measuring inserts Ø 1.5 mm.

Accessories : carbide measuring inserts SYLVAC® type, half-knife shaped + table

MSA	Item
15.171-010	Pair of inserts thickness 0.10, usable length 2.20, width 4 mm
15.171-012	Pair of inserts thickness 0.12, usable length 2.20, width 4 mm
15.171-015	Pair of inserts thickness 0.15, usable length 2.20, width 4 mm
15.171-020	Pair of inserts thickness 0.20, usable length 2.20, width 4 mm
15.171-030	Pair of inserts thickness 0.30, usable length 2.20, width 4 mm
15.171-040	Pair of inserts thickness 0.40, usable length 2.20, width 4 mm
15.171-070	Pair of inserts thickness 0.70, usable length 2.20, width 4 mm
15.172	Table "H" shaped with XZ adjustment

Horizontal measuring bench for INTERNAL measurements, can be used with interchangeable measuring inserts SYLVAC® and CARY® types.

 sylvac



MSA	Measuring range	Resolution	Kg
15.175	12 - 62 mm	0.0001 mm	5.100

SYLVAC® PS16 V2 LV horizontal measuring bench for internal measurements similar to the MSA15.170, but equipped with a table and anvils assembly allowing to measure internal diameters from Ø 12 to 62 mm.

- Originally designed for measuring watch cases, it is also suitable for measuring rings and thin parts.
- 2-point measurement with positioning of the workpiece in the measuring axis by 2 movable centring pins
- Table height adjustable by up to 20 mm.

Delivered with two 0.4 mm thick measuring inserts.

Horizontal measuring benches for internal measurements.

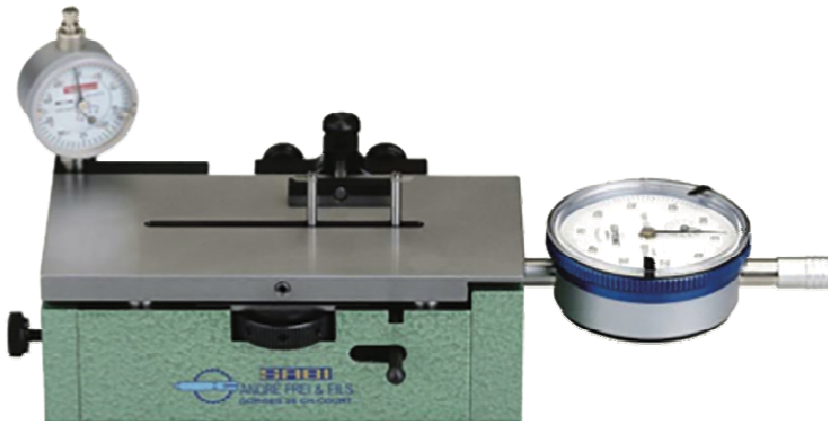

MSA	Size
15.574	235 x 110 x 100 mm

Internal or external measuring bench H 04 type.
 - Height of the adjustable table from 0 to 20 mm
 - Internal measuring capacity from 5.50 to 65.00 mm
 - External measuring capacity from 1.50 to 60.00 mm
 - Travel 10 mm.

Delivered without indicator.



MSA
15.575

Pair of groove measuring inserts for measuring bench MSA15.574.
 - Internal measuring capacity from 15.50 to 73 mm
 - Thickness 0.25 mm.

Height gauges.



MSA	Measuring range	Degree of protection	Kg
15.491	0 - 100 mm / 0 - 4"	IP50	20.000

μHITE 160 height gauge.

Compact design with measuring stand included. The perfect combination for small parts and when a low measuring force is required. The whole system provides the best solution for measuring straightness, flatness and parallelism or inspecting axial and radial runouts, depending on the chosen tool configuration.

Granite measuring table 200 x 300 x 50 mm (W x D x H) ; dull-chrome plated steel column Ø 50 x 300 mm, hardened and ground ; fixing for measuring inserts Ø 6 mm x length 10 mm.

Features :

- Ideal for work piece inspection close to the production area
- Application range from 0 to 160 mm or 0 to 6.3"
- Digital display : 0.001 mm and 0.0001 mm or 0.0001 in and 0.00001"
- Maximum permissible error as low as 2 µm (or 1 µm when checking coaxiality) thanks to the automatic correction of systematic errors by CAA (Computer Aided Accuracy)
- Integrated temperature sensor so that the coefficient of linear expansion of each gauge unit matches that of steel (11,5 x 10-6 K-1)
- Motorised measuring head for fast probing at each point
- Automatic value capture, controlled over the stability of the measuring force, but also all measured values
- Constant measuring force through the motor-driven actuator. Switchable
- No manual calculation needed
- RS232 data output with direct connection to TESA PRINTER SPC
- Memory capacity for 99 single values.

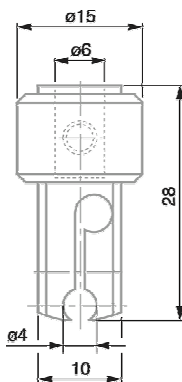

MSA
15.519

Radial probe holder with mounting bore Ø 4 mm.

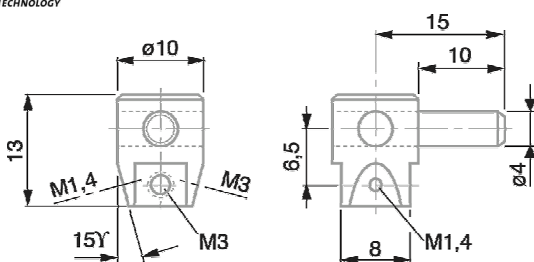

MSA
15.460

Universal probe insert holder with clamping shank Ø 4 mm (to be used with radial probe holder MSA15.519).

M1.4 and M3 threads (2x2) for measuring inserts.



MSA

15.470

Foot switch for triggering data transfer or letting a measuring function be repeated.

Jack plug connector, 1.8 m (TESA SPC PRINTER printer - TESATRONIC TT display units).

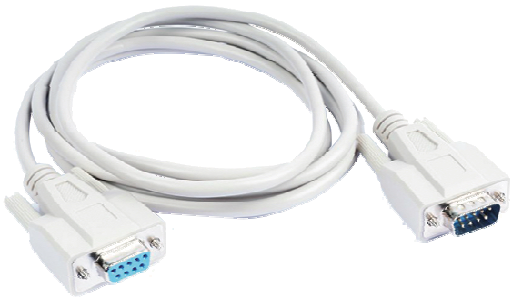

MSA

Length

15.488

2 m

Standard Sub-D connection cable between TESA PRINTER SPC and measuring instruments TESA- μ HITE, TESA-HITE and TESA MICRO-HITE. Sub-D 9p/m connector.

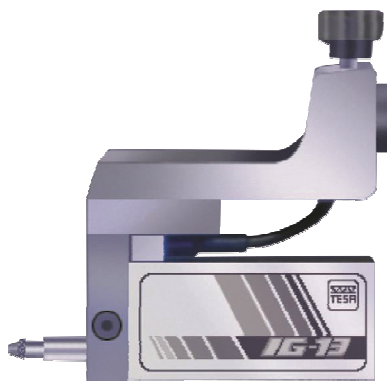

MSA

15.498

IG-13 probe set for perpendicularity measurement.

Composed of :

- 1 IG-13 electronic probe
- 1 fixing device for IG-13 probe.



MSA	Model	Measuring range
15.495	350	0 - 520 mm / 0 - 20"
15.497	(1) 600	0 - 770 mm / 0 - 30"

MICRO-HITE 350 / 600 new height gauge.

This manual 2D height gauge is mainly used in workshops and offers comfortable and accurate positioning, which is very useful during the measurement of small elements.

Thanks to its robustness, this instrument is very reliable and guarantees excellent repeatability and precision under any circumstances, but especially when used with extensions and small probes.

The interchangeable battery makes it possible to easily handle the instrument in places without access to power supply.

Features :

- Rugged nickel plated base with bottom face including 3 resting points finely lapped
- Application range 0 - 520 mm or 0 - 20" (MSA15.495) ; 0 - 825 mm or 0 - 30" (MSA15.497)
- State-of-the-art concept associated with a high-quality design is the fruit of years of experience in the manufacture of electronic height gauges
- Ideal for dimensional inspection close to the manufacturing cell
- Fast, simple and reliable probing of the workpiece or holes, especially
- 2 main gauges available with either a 520 or 770 mm measuring span
- Numerical display to 0.0001, 0.001, 0.01 and 0.1 mm, or equivalent inch units
- Extremely accurate measuring of deviations from length, straightness and perpendicularity due to the automatic correction of the bias errors through CAA (Computer Aided Accuracy)
- Degree of protection IP20
- Maximum permissible errors $2+2L/1000$
- Maximum permissible perpendicularity error : frontal $7 \mu\text{m}$, lateral $7 \mu\text{m}$
- Measuring force $1.6 \pm 0.25 \text{ N}$ (to the triggering point of the seizure)
- Coefficient of linear expansion identical to steel ($11,5 \times 10^{-6} \text{ K}^{-1}$).

2D panel :

- Colour and touch screen
- Simplified measurement in 2D
- Facilitated creation of the control ranges
- Choice of the data management :
 - On USB key (file *.txt)
 - Direct printing on printer
 - Connection to 1 PC for the statistical data management
 - Information results in real time.
- Every height gauge comes with a SCS calibration certificate.

Marbles and steel supports.



MSA	Granite plates size	Kg
15.374	800 x 500 x 100 mm	120.000
15.372	900 x 600 x 100 mm	210.000
15.375	1000 x 630 x 100 mm	260.000
15.376	1200 x 800 x 120 mm	350.000
15.377	1500 x 1000 x 150 mm	680.000

Black granite plate.
Precision grade DIN 876/0.
Delivered with control report.



MSA	Granite plates size
15.374-S	800 x 500 x 100 mm
15.372-S	900 x 600 x 100 mm
15.375-S	1000 x 630 x 100 mm
15.376-S	1200 x 800 x 120 mm
15.377-S	1500 x 1000 x 150 mm

Steel support for black granite plates MSA15.37x, respecting the Bessel points.
Working height 900 mm.
Delivered without black granite plate.



MSA	Granite plates size
15.378	800 x 500 x 100 mm

Support cabinet with 3 metal drawers for black granite plates MSA15.37x.
Built based on Bessel points, with anti-slip protection.
Working height 900 mm.
Delivered without black granite plate.

Roughness gauges.



MSA	Size	Kg
15.490	122 x 60 x 62 mm	0.650

RUGOSURF 20.

Portable roughness gauge, robust and versatile. Designed for production environments or inspection of goods.

- Measuring range in the Z-axis of 400 µm (0.0157 in), 16 mm (0.63 in) in the X-axis
- Probe with diamond point 2 µm
- Sturdy metallic base
- Membrane keyboard, degree of protection IP67
- 15 roughness parameters. Each parameter can be activated individually or not. Tolerancing of each parameter value possible
- 2" LCD display, roughness settings and profile after each measurement
- Very simple to use
- Direct display:
 - of all measured values, with tolerance levels
 - of R roughness profile
 - the Bearing Area Curve (BAC)
 - the Amplitude Distribution Curve (ADC)
- Flexible autonomy through mains adapter or battery pack
- Storage of the measured parameters
- Multilingual menu options
- USB cable connection (optional)
- Direct printing to a dot matrix printer (optional)
- Measurement transfer, database creation and reporting available using TESA RUGOSOFT software tool (optional)
- Access to narrow and hard to reach locations possible through 100 mm probe extension (optional).



MSA	Size	Kg
15.492	270 x 140 x 90 mm	3.000

RUGOSURF 90G.

Small-size, versatile roughness gauge with tactile colour screen providing maximum ease of use. Ideally suited for high-precision measurements on the shop floor or in the inspection laboratory

- Measuring range in the Z-axis of 1000 µm (0.0394 in), 50 mm (0.1.968 in) in the X-axis
- W ripple profiles, P primary profile and R roughness profile measuring
- Tactile TFT 3.5" colour screen
- 3-position horizontal measurement at -90 °, 0 °, 90 °
- 49 roughness parameters
- Delivered with a 2-in-1 special probe with removable pad : one single probe can be used to measure roughness or undulation
- Vertical adjusting screw for probe positioning up to a height of 90 mm without the need of an accessory
- Tolerance of all parameters possible
- USB digital output for transfer of measured values to a PC with TESA MEASUREMENT STUDIO software (optional).

NOTES
