

# 17

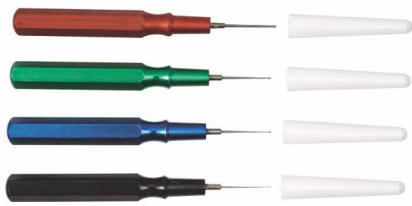

OILERS

17 - 2

OIL CUPS

17 - 6

PACKAGING

17 - 8

Simple oilers : the flat metallic needle of the oiler allows precise oiling of all parts of the movement.

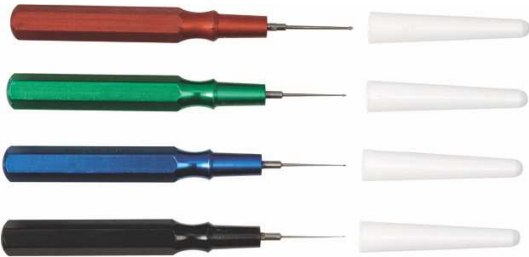

**ASSORTMENT**

MSA	Kg
17.000-04	0.016

Assortment of 4 simple oilers with protective caps. Aluminium handle Ø 6 mm, colour coded for easy identification of the spatula width.

Contents : MSA17.000-A, -C, -D and -E.

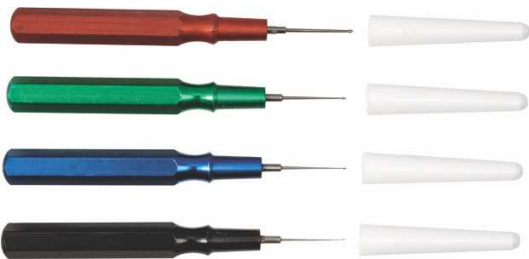

**INDIVIDUAL**

MSA	Colour	Length	Needle	Kg
17.000-A	Red	70 mm	Large	0.004
17.000-C	Green	70 mm	Medium	0.004
17.000-D	Blue	70 mm	Fine	0.004
17.000-E	Black	70 mm	Very fine	0.004

Simple oiler with aluminium handle Ø 6 mm. See assortment MSA17.000-04.

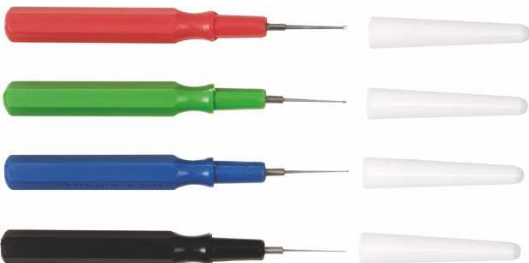

**ASSORTMENT**

MSA	Kg
17.001-04	0.006

Assortment of 4 simple oilers with protective caps. Plastic handle Ø 6 mm, colour coded for easy identification of the spatula width.

Contents : MSA17.001-A, -C, -D and -E.

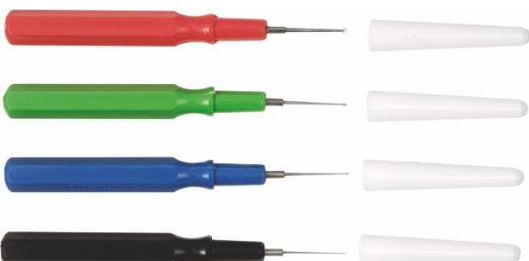

**INDIVIDUAL**

MSA	Colour	Length	Needle	Kg
17.001-A	Red	70 mm	Large	0.001
17.001-C	Green	70 mm	Medium	0.001
17.001-D	Blue	70 mm	Fine	0.001
17.001-E	Black	70 mm	Very fine	0.001

Simple oiler with plastic handle Ø 6 mm. See assortment MSA17.001-04.



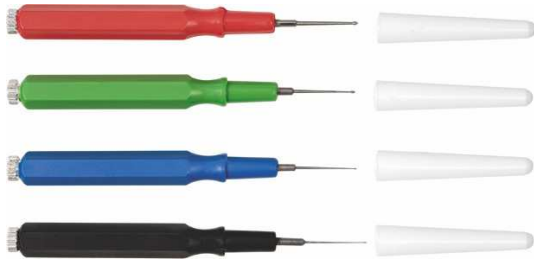

**ASSORTMENT**

MSA	Kg
17.002-04	0.008

Assortment of 4 oilers with interchangeable needles and protective caps. Plastic handle Ø 6 mm, colour coded for easy identification of the spatula width, with 2 replacement needles inside each handle.

Contents : MSA17.002-A, -C, -D and -E.

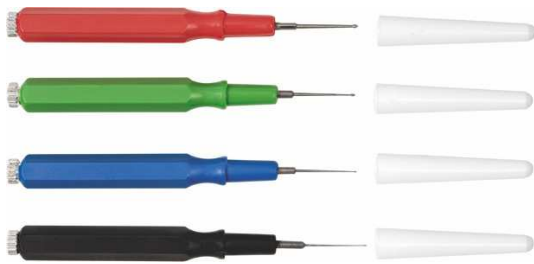

**INDIVIDUAL**

MSA	Colour	Length	Needle	Kg
17.002-A	Red	72 mm	Large	0.002
17.002-C	Green	72 mm	Medium	0.002
17.002-D	Blue	72 mm	Fine	0.002
17.002-E	Black	72 mm	Very fine	0.002

Oiler with plastic handle Ø 6 mm with 2 replacement needles inside. See assortment MSA17.002-04.

**Spare parts :**

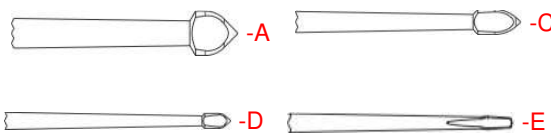

MSA	Item	Kg
17.002P-A	Needle for MSA17.002-A	0.001
17.002P-C	Needle for MSA17.002-C	0.001
17.002P-D	Needle for MSA17.002-D	0.001
17.002P-E	Needle for MSA17.002-E	0.001

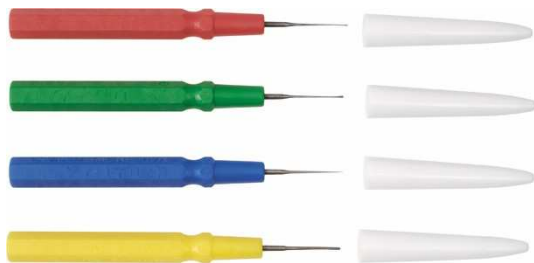

**ASSORTMENT**

MSA	Kg
17.102-04	0.006

Assortment of 4 simple oilers with protective caps. Plastic handle Ø 5 mm, colour coded for easy identification of the spatula width.

Contents : MSA17.102-D, -C, -B and -A.



**INDIVIDUAL**

MSA	Colour	Length	Needle	Kg
17.102-D	Yellow	70 mm	Very large	0.001
17.102-C	Green	70 mm	Large	0.001
17.102-B	Blue	70 mm	Medium	0.001
17.102-A	Red	70 mm	Fine	0.001
17.102-E	Black	70 mm	Fine	0.001

Simple oiler with plastic handle Ø 5 mm. See assortment MSA17.102-04.

**Spare parts :**

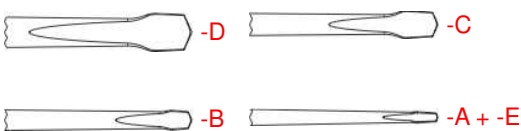

MSA	Item	Kg
17.102P-D	Needle for MSA17.102-D	0.001
17.102P-C	Needle for MSA17.102-C	0.001
17.102P-B	Needle for MSA17.102-B	0.001
17.102P-A	Needle for MSA17.102-A and MSA17.102-E	0.001

## OILERS

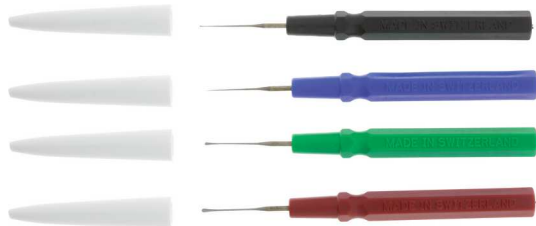

### ASSORTMENT

MSA	Kg
17.101-04	0.006

Assortment of 4 simple oilers with protective caps.  
Plastic handle Ø 5 mm, colour coded for easy identification of the spatula width.  
Contents : MSA17.101-A, -B, -C and -D.

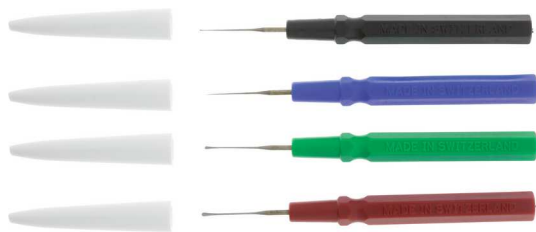

### INDIVIDUAL



MSA	Colour	Length	Needle	Kg
17.101-A	● Black	70 mm	Fine	0.001
17.101-B	● Blue	70 mm	Medium	0.001
17.101-C	● Green	70 mm	Large	0.001
17.101-D	● Red	70 mm	Very large	0.001

Simple oiler with antistatic plastic handle Ø 5 mm.



MSA	Length	Kg
17.003	70 mm	0.004

Precision Incabloc oiler, with aluminium gilt handle Ø 6 mm and 3 replacement needles inside.



### Spare part :

MSA	Item	Kg
17.003-01	Needle	0.001



## Oilers.



MSA	Colour	Needle internal Ø	Needle external Ø	Kg
17.050	 Pink	0.12 mm	0.30 mm	0.040
17.051	 Cream	0.15 mm	0.35 mm	0.040
17.052	 Dark blue	0.17 mm	0.42 mm	0.040

JISMAA oiler for escapement and pallet forks.





*Delivered with 1 stand.*

*Use with JISMAA oils recommended (see chapter 28).*

## Spare parts :

MSA	Item	Kg
17.050-R	Oil container for MSA17.050	0.001
17.051-R	Oil container for MSA17.051	0.001
17.052-R	Oil container for MSA17.052	0.001



MSA	Colour	Needle internal Ø	Needle external Ø	Kg
17.060	 Matt red	0.10 mm	0.30 mm	0.040
17.061	 Black	0.15 mm	0.38 mm	0.040
17.062	 Light blue	0.20 mm	0.45 mm	0.040
17.063	 Purple	0.30 mm	0.55 mm	0.040

JISMAA oiler for gear train and cap jewels.

*Delivered with 1 stand.*

*Use with JISMAA oils recommended (see chapter 28).*

## Spare parts :

MSA	Item	Kg
17.060-R	Oil container for MSA17.060	0.001
17.061-R	Oil container for MSA17.061	0.001
17.062-R	Oil container for MSA17.062	0.001
17.063-R	Oil container for MSA17.063	0.001



MSA	Volume	Size	Kg
17.210	6 cc	Ø 13 x 155 mm	0.028

Lubristyl® precision oil pen, pen shape.

Drop by drop lubricant dispenses thanks to the needle pump. Possibility to easily re-absorb the extra oil by briefly and rapidly pushing the needle.

*Delivered with 6 cc oil.*

## Spare part :

MSA	Item	Kg
17.210-100	Oil refill, 100 ml	0.113



## OIL CUPS



MSA	Size
17.106	145 x 45 x 25 mm

Assortment of 4 anodized aluminium oil cups with ceramic cups. The oil cups can be used individually and can also be inserted on the base plate.

### Contents :

- MSA17.105-P : anodised grey aluminium base plate
- MSA17.105-01 : anodised red aluminium oil cup
- MSA17.105-02 : anodised blue aluminium oil cup
- MSA17.105-03 : anodised green aluminium oil cup
- MSA17.105-04 : anodised yellow aluminium oil cup.

### Spare parts :



MSA	Item
17.105-01	Anodised red aluminium oil cup with base and cover, Ø 25 x height 13.90 mm, white ceramic cup Ø 14.50 x height 3 mm, well Ø 6 mm
17.105-02	Anodised blue aluminium oil cup with base and cover, Ø 25 x height 13.90 mm, white ceramic cup Ø 14.50 x height 3 mm, well Ø 8 mm
17.105-03	Anodised green aluminium oil cup with base and cover, Ø 25 x height 13.90 mm, white ceramic cup Ø 14.50 x height 3 mm, well Ø 9 mm
17.105-04	Anodised yellow aluminium oil cup with base and cover, Ø 25 x height 13.90 mm, white ceramic cup Ø 14.50 x height 3 mm, well Ø 10 mm
17.105-P	Aluminium base plate, 145 x 45 x 8 mm



MSA	Size	Kg
17.103	95 x 60 x 65 mm	0.275

Complete aluminium oil cup.

### Contents :

- Shot blasted aluminium base, grey anodized
  - 4 white ceramic cups
  - 4 oilers with aluminium handle Ø 6 mm in different colours.
- The cups can be replaced individually.

### Spare parts :

MSA	Item	Kg
17.000-A	Red oiler with large needle, length 70 mm	0.004
17.000-C	Green oiler with medium needle, length 70 mm	0.004
17.000-D	Blue oiler with fine needle, length 70 mm	0.004
17.000-E	Black oiler with very fine needle, length 70 mm	0.004
17.103-01	Cup Ø ext. 14.50 x height 3 mm, well Ø 6 mm	0.003
17.103-02	Cup Ø ext. 14.50 x height 3 mm, well Ø 8 mm	0.003
17.103-03	Cup Ø ext. 14.50 x height 3 mm, well Ø 9 mm	0.003
17.103-04	Cup Ø ext. 14.50 x height 3 mm, well Ø 10 mm	0.003



MSA	Size	Kg
17.104	95 x 60 x 65 mm	0.275

Complete aluminium oil cup.

Contents :

- Shot blasted aluminium base, grey anodized
  - 4 synthetic ruby cups
  - 4 oilers with aluminium handle Ø 6 mm in different colours.
- The cups can be replaced individually.

#### Spare parts :

MSA	Item	Kg
17.000-A	Red oiler with large needle, length 70 mm	0.004
17.000-C	Green oiler with medium needle, length 70 mm	0.004
17.000-D	Blue oiler with fine needle, length 70 mm	0.004
17.000-E	Black oiler with very fine needle, length 70 mm	0.004
17.104-01	Cup Ø ext. 14.50 x height 3 mm, well Ø 6 mm	0.003
17.104-02	Cup Ø ext. 14.50 x height 3 mm, well Ø 8 mm	0.003
17.104-03	Cup Ø ext. 14.50 x height 3 mm, well Ø 9 mm	0.003
17.104-04	Cup Ø ext. 14.50 x height 3 mm, well Ø 10 mm	0.003



MSA	Size	Kg
17.201	83 x 40 x 26 mm	0.100

Four-oil cup chrome-plated stand allowing the deposit of oils and grease.

The complete set is chromes and includes :

- 4 cups in anti-hygrometric glass
  - 1 mobile black plastic lid to protect oil from dust
  - 3 holes filled with pith wood for cleaning the oilers
  - 1 groove for oiler storage
  - 1 anti-skid rubber sole to ensure a good stability.
- Delivered without oilers.



MSA	External Ø	Internal Ø	Kg
17.100	40 mm	25 mm	0.055

Fluted glass oil cup.

Stackable boxes and lids for watch after sales service.



MSA	Colour	Size	Kg
17.527-B	Blue	236 x 105 x 17 mm	0.095
17.527-J	Yellow	236 x 105 x 17 mm	0.095
17.527-R	Red	236 x 105 x 17 mm	0.095
17.527-V	Green	236 x 105 x 17 mm	0.095
17.527-W	White	236 x 105 x 17 mm	0.095

Plastic container with 6 compartments.  
 - 5 compartments 49 x 44 x 15 mm  
 - 1 compartment 49 x 44 x 15 mm.  
 ATTENTION : lid sold separately.



MSA	Colour	Size	Kg
17.530-B	Blue	236 x 105 x 17 mm	0.104
17.530-J	Yellow	236 x 105 x 17 mm	0.104
17.530-R	Red	236 x 105 x 17 mm	0.104
17.530-V	Green	236 x 105 x 17 mm	0.104

Plastic container with 10 compartments.  
 - Compartments 49 x 44 x 15 mm.  
 ATTENTION : lid sold separately.



MSA	Size	Kg
17.528 (1)	246 x 112 x 20 mm	0.090
17.572 (2)	246 x 112 x 20 mm	0.102

Transparent lid with stacking cam for plastic containers MSA17.527-x and MSA17.530-x.

(1) With locking holes  
 (2) Without locking holes



MSA	Colour	Use with	Kg
17.531-1	Black	1 lid + 1 container	0.001
17.531-2	Yellow	1 lid + 2 containers	0.001
17.531-3	Red	1 lid + 3 containers	0.001
17.531-4	Green	1 lid + 4 containers	0.001
17.531-5	Blue	1 lid + 5 containers	0.001

Plastic key (5 colours) allowing to firmly link one or several containers MSA17.527-x and MSA17.530-x.



MSA	Size	Kg
17.532	49 x 41 x 16 mm	0.003

Foam insert for plastic containers MSA 17.527-x and MSA17.530-x.



MSA	Size	Kg
17.532-A	232 x 48 x 15 mm	0.023

Foam insert for plastic containers MSA 17.527-x.



Plastic boxes with elastic membrane box, ideal to protect delicate, round, pointed or deformed objects of different sizes without risk of oxidation.

The transparency of the packaging allows a visual control.

The bottoms and the lids of the boxes are interchangeable and equipped with a thin polyurethane membrane.

The objects stay still and suspended inside the box.



MSA		Size		Kg
17.650		39 x 39 x 18 mm		0.008

Complete membrane plastic box.  
Composed of a lower and upper half box.



MSA		Size	Quantity	Kg
17.663	(1)	120 x 79 x 17.80 mm	6	0.046
17.662	(2)	240 x 79 x 17.80 mm	12	0.091

Set of 6 or 12 membrane plastic boxes.  
Delivered with 1 bottom and 1 lid.  
Exterior size of one box : 39 x 39 x 17.8 mm.



MSA		Size		Kg
17.677	(1)	34 x 34 x 25 mm		0.014
17.678	(2)	50 x 50 x 25 mm		0.032

Complete membrane plastic box.  
Composed of a lower and upper half box, hinge and lockers.



MSA		Size		Kg
17.682		100 x 100 x 40 mm		0.085

Complete membrane plastic box.  
Composed of a lower and upper half box, hinge and lockers.

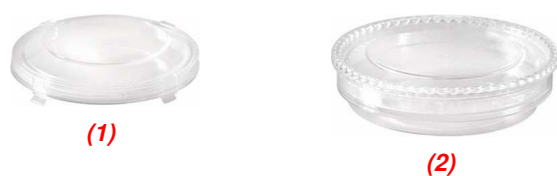

MSA		Size		Kg
17.664	(1)	Ø 82 x 17 mm		0.020
17.665	(2)	Ø 82 x 40 mm		0.030

Round membrane plastic boxes.  
Delivered with 1 bottom and 1 lid.

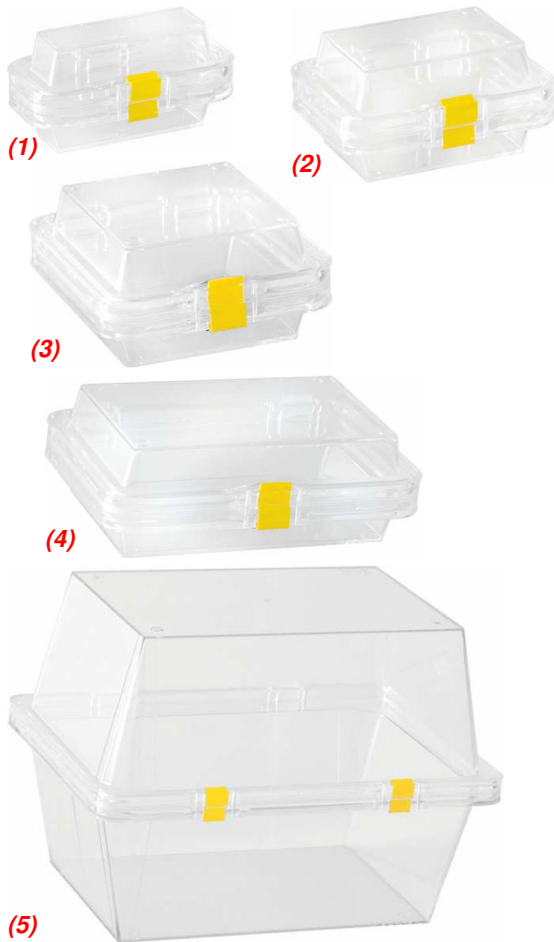

MSA		Size	Kg
17.684		50 x 50 x 25 mm	0.020
17.653	(1)	100 x 50 x 50 mm	0.044
17.670		100 x 75 x 25 mm	0.054
17.654	(2)	100 x 75 x 50 mm	0.063
17.671		100 x 100 x 25 mm	0.075
17.655	(3)	100 x 100 x 50 mm	0.076
17.676		125 x 125 x 50 mm	0.106
17.672		150 x 100 x 25 mm	0.093
17.656	(4)	150 x 100 x 50 mm	0.103
17.673		150 x 150 x 50 mm	0.148
17.657		150 x 150 x 100 mm	0.177
17.674		200 x 100 x 50 mm	0.133
17.658		200 x 100 x 75 mm	0.141
17.659		200 x 200 x 50 mm	0.238
17.679		250 x 200 x 25 mm	0.343
17.675		250 x 200 x 50 mm	0.343
17.660		250 x 200 x 100 mm	0.375
17.661	(5)	275 x 200 x 200 mm	0.550
17.651		300 x 75 x 25 mm	0.143
17.668		300 x 75 x 50 mm	0.162
17.669		300 x 100 x 50 mm	0.195

Complete membrane plastic box.  
Composed of a lower and upper half box, hinge and lockers.

**Spare part :**

MSA	Item
17.699	Transparent hinge for membrane box. Delivered in bag of 100 pieces

**Boxes for spare parts.**



MSA	Size	Kg
17.505	260 x 105 x 24 mm	0.260

Plastic box. Black structured bottom and transparent lid with hinges and stacking notches.

Contents :  
- 21 cases Ø 24 mm  
- 2 cases Ø 40 mm.



MSA	Size	Kg
17.506	260 x 105 x 24 mm	0.266

Plastic box. Black structured bottom and transparent lid with hinges and stacking notches.

Contents :  
- 10 cases Ø 24 x 16 mm  
- 7 rectangular boxes 44 x 24 x 19 mm  
- 2 square boxes 48 x 48 x 20 mm.



MSA	Compartments	Size	Kg
17.564	253 x 97 x 20 mm	260 x 105 x 25 mm	0.148

Plastic box with 1 compartment. Black structured bottom and transparent lid with hinges and stacking notches.



MSA	Compartments	Size	Kg
17.507	49 x 48 x 18 mm	260 x 105 x 25 mm	0.170

Plastic box with 10 compartments. Black structured bottom and transparent lid with hinges and stacking notches.

*The following plastic boxes can be inserted : MSA17.503, 17.504 and 17.508.*



MSA	External size	Internal size	Kg
17.504	48 x 48 x 20 mm	42 x 42 x 15 mm	0.013

Square plastic box. Transparent bottom and lid.  
*Can be used as an insert in the plastic box MSA17.507.*



MSA	External size	Internal size	Kg
17.503-17	44 x 24 x 17 mm	40 x 20 x 15 mm	0.005
17.503	44 x 24 x 19 mm	40 x 20 x 17 mm	0.006

Rectangular plastic box. Transparent bottom and lid.  
*Can be used as an insert in the plastic box MSA17.507.*



MSA	External size	Internal size	Kg
17.508	23 x 23 x 19 mm	20 x 20 x 17 mm	0.004

Square plastic box. Transparent bottom and lid.  
*Can be used as an insert in the plastic box MSA17.507.*



MSA	Compartments	Size	Kg
17.565	123 x 97 x 20 mm	130 x 105 x 25 mm	0.075

Plastic box 1 compartment. Black bottom and transparent lid with hinges and stacking notches.



MSA	Compartments	Size	Kg
17.567	47 x 23 x 18 mm	130 x 105 x 25 mm	0.080

Plastic box 10 compartments. Black bottom and transparent lid with hinges and stacking notches.



MSA	Compartments	Size	Kg
17.515	55 x 60 x 22 mm	296 x 135 x 32 mm	0.300

Plastic box with 10 compartments. Light blue bottom and transparent lid with hinges and stacking notches.



MSA	Compartments	Size	Kg
17.519	32 x 32 x 9.50 mm	350 x 180 x 16 mm	0.330

Plastic box with 50 compartments. Light blue bottom and transparent lid with hinges and stacking notches.



MSA	Compartments	Size	Kg
17.533	13 x 11 x 4.50 mm	152 x 70 x 11 mm	0.060

Plastic box with 50 compartments. Light blue bottom and transparent lid with hinges and stacking notches.



MSA	Compartments	Size	Kg
17.534	20 x 17.50 x 4.50 mm	220 x 105 x 11 mm	0.130

Plastic box with 50 compartments. Light blue bottom and transparent lid with hinges and stacking notches.



MSA	Compartments	Size	Kg
17.535	31.50 x 17.50 x 4.50 mm	340 x 100 x 11 mm	0.175

Plastic box with 50 compartments. Light blue bottom and transparent lid with hinges and stacking notches.

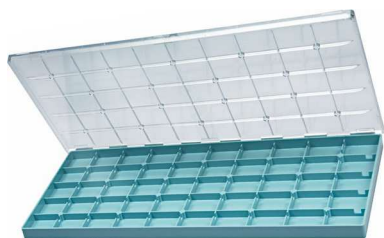

MSA	Compartments	Size	Kg
17.541	10 x 8 x 4.50 mm	121 x 55 x 11 mm	0.040

Plastic box with 50 compartments. Light blue bottom and transparent lid with hinges and stacking notches.



MSA	Compartments	Size	Kg
17.510	30 x 21 x 8 mm	120 x 70 x 15 mm	0.050

Plastic box with 10 compartments. Light blue bottom and transparent sliding lid with stacking notches.



MSA	Compartments	Size	Kg
17.512	36 x 11 x 18.50 mm	120 x 70 x 25 mm	0.075

Plastic box with 15 compartments. Light blue bottom and transparent sliding lid with stacking notches.



MSA	Compartments	Size	Kg
17.500	50 x 32 x 18 mm	207 x 112 x 23 mm	0.140

Plastic box with 12 compartments. Light grey bottom and transparent lid with hinges and stacking notches.



MSA	Compartments	Size	Kg
17.566	50 x 39 x 18 mm	207 x 112 x 23 mm	0.120

Plastic box 10 compartments. Light grey bottom and transparent lid with hinges and stacking notches.

## PACKAGING



MSA	Compartments	Size	Kg
<b>17.501</b>	15 x 33 x 18 mm	207 x 112 x 23 mm	0.140

Plastic box with 36 compartments. Transparent bottom and lid with hinges and stacking notches.

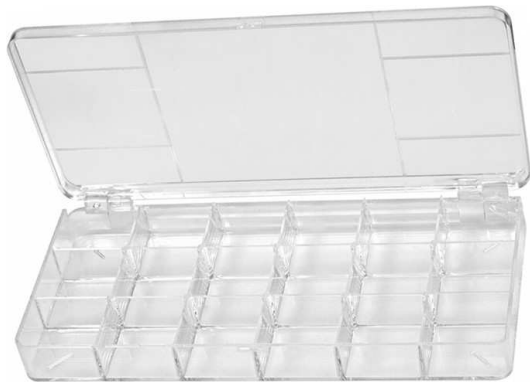

MSA	Compartments	Size	Kg
<b>17.579</b>	33 x 33 x 32 mm	210 x 112 x 35 mm	0.174

Non-stackable plastic box with 18 compartments. Transparent bottom and lid with hinges.



MSA	Compartments	Size	Kg
<b>17.509</b>	46 x 6 x 6 mm	84 x 54 x 16 mm	0.028

Stackable plastic box with 10 compartments. Transparent bottom and lid.



MSA	Compartments	Size	Kg
<b>17.516</b>	22 x 11 x 7 mm	84 x 54 x 16 mm	0.025

Stackable plastic box with 12 compartments. Transparent bottom and lid.



MSA	Compartments	Size	Kg
<b>17.539</b>	75 x 12 x 7 mm	84 x 54 x 16 mm	0.025

Stackable plastic box with 5 compartments. Transparent bottom and lid.



MSA	Compartments	Size	Kg
<b>17.520</b>	10 x 29 x 10 mm	108 x 64 x 13 mm	0.035

Non-stackable plastic box with 18 compartments. Transparent bottom and lid.



MSA	External size	Internal size	Kg
17.522	36 x 26 x 6 mm	31 x 21 x 4 mm	0.003

Non-stackable rectangular plastic box. Transparent bottom and lid.



MSA	Compartments	Size	Kg
17.523	29 x 13 x 14 mm	90 x 64 x 17 mm	0.037

Stackable plastic box with 12 compartments. Yellow bottom and transparent lid with stacking notches.



MSA	External size	Internal size	Kg
17.524	90 x 68 x 21 mm	85 x 61 x 16 mm	0.027

Rectangular plastic box. Transparent bottom and lid.



MSA	External size	Internal size	Kg
17.589	81 x 56 x 19 mm	75x49x16 mm	0.020

Rectangular plastic box. Transparent bottom and lid.



MSA	External size	Internal size	Kg
17.538	88 x 47 x 15 mm	84 x 44 x 11 mm	0.020

Rectangular plastic box. Grey bottom and transparent lid.



MSA	Compartments	Size
17.545	20 x 17,50 x 5 mm	220 x 105 x 11 mm

Non-stackable plastic box with 50 compartments. Light blue bottom and transparent lid, for balances.



MSA	Compartments	Size	Kg
17.571	1x 19 x 19 x 13 mm 6x 20 x 9 x 13 mm	44 x 44 x 16 mm	0.010

Square plastic box with 7 compartments and lid.

PACKAGING



MSA	External size	Internal size	Kg
17.525	Ø 40 x 12 mm	Ø 35 x 9 mm	0.005

Round plastic box. Transparent bottom and lid attached.



1000 pieces

MSA	Size	Quantity	Kg
17.529	Ø 7 x 24 mm	1000	0.100

Transparent packaging capsule.



100 pieces

MSA	External size	Internal size	Kg
17.536	9 x 9 x 23 mm	6 x 6 x 19 mm	0.072

Square plastic tube. Transparent bottom and red lid.



100 pieces

MSA	External size	Internal size	Kg
17.537	9 x 9 x 39 mm	6 x 6 x 35 mm	0.124

Square plastic tube. Transparent bottom and red lid.



1000 pieces

MSA	External size	Internal size	Quantity	Kg
17.542	Ø 7.5 x 33 mm	Ø 6 x 29 mm	1000	3.000

Round transparent plastic tube.

Caps in different colours to be ordered separately. See list below.



1000 pieces



MSA	Colour	Size	Quantity	Kg
17.542-001	Red	Ø 10 x 8 mm	1000	1.000
17.542-002	Light green	Ø 10 x 8 mm	1000	1.000
17.542-003	Yellow	Ø 10 x 8 mm	1000	1.000
17.542-004	Blue	Ø 10 x 8 mm	1000	1.000
17.542-005	Grey	Ø 10 x 8 mm	1000	1.000
17.542-006	White	Ø 10 x 8 mm	1000	1.000
17.542-007	Dark green	Ø 10 x 8 mm	1000	1.000
17.542-008	Dark pink	Ø 10 x 8 mm	1000	1.000
17.542-009	Purple	Ø 10 x 8 mm	1000	1.000
17.542-010	Brown	Ø 10 x 8 mm	1000	1.000
17.542-011	Black	Ø 10 x 8 mm	1000	1.000
17.542-012	Light pink	Ø 10 x 8 mm	1000	1.000

Plastic cap for tube MSA17.542.



MSA	Size	Kg
17.577	Ø 16 x 9 mm	0.001

Round plastic box, transparent bottom and lid.



1000 pieces

MSA	Size	Quantity
17.540-A	Ø 17 x 8 mm	1000
17.540-B	Ø 17 x 12 mm	1000
17.540-C	Ø 22 x 13 mm	1000

Round plastic box, transparent bottom and lid.



100 pieces

MSA	Size	Quantity	Kg
17.807	Ø 24 x 16 mm	100	0.150
17.812	Ø 33 x 16 mm	100	-
17.813	Ø 40 x 16 mm	100	0.580

Round plastic box, transparent bottom and lid.



MSA	Size	Kg
17.801-09	Ø 50 x 35 mm (50 ml)	0.008
17.801-3619 *	Ø 36 x 19 mm (10 ml)	0.006
17.801-5120 *	Ø 51 x 20 mm (30 ml)	0.009

Round aluminium box.

\* Screw-on lid



MSA	Size	Kg
17.809	44 x 44 x 17 mm	0.020

Square aluminium box, transparent plastic lid.

## PACKAGING



MSA	Calibre	Hole(s) for stem(s)	Quantity	Kg
17.800-01	4"	1	50	0.218
17.800-04	(1) 5 1/2"	1	50	0.149
17.800-06	(2) 6 3/4" x 8"	1	50	0.105
17.800-08	(3) 7 3/4"	1	50	0.120
17.800-10	8 3/4"	1	50	0.137
17.800-12	10 1/2"	1	50	0.161
17.800-13	11 1/2"	1	50	0.215
17.800-02	11 3/4"	4	50	0.187
17.800-14	12 1/2"	1	50	0.265
17.800-18	13 1/4"	1	50	0.158
17.800-15	13 1/2"	1	50	0.345

Plastic case with bottom and lid to protect movements.

Packaging: 50 complete cases (except MSA17.800-17, 1 piece)

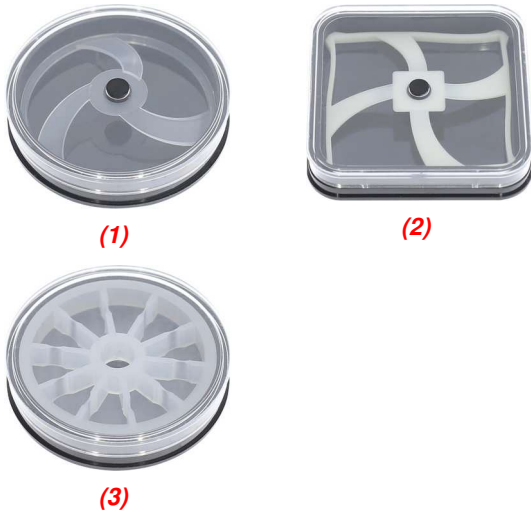

MSA	Shape	Internal size	Kg
17.583-35	(1) Round	Ø 35 mm	0.007
17.583-45	(1) Round	Ø 45 mm	0.010
17.583-60	(1) Round	Ø 60 mm	0.014
17.584-40	(2) Square	40 x 40 mm	0.011
17.585-35	(3) Round	Ø 35 mm	0.010

Plastic case for dial and spare parts packing.

(1+2) : For dials (1 base / 1 lid / 1 flexible support / 1 flexible point).

(3) : For spare parts (1 base / 1 lid / 1 insert).



MSA	Volume	Size	Kg
17.526	50 ml	Ø 42 x 42.50 mm	0.007

Transparent plastic container with lid.



MSA	Size	Kg
17.196	480 x 230 x 230 mm	1.530

Tool box 19".  
 - Inside tray with handle  
 - Lid "organiser" with 7 cases.  
*Delivered without tools.*



MSA	Size	Kg
17.197	25 x 13 x 41 mm	0.059

Padlock for tool box MSA17.196.  
 - Hardened steel shackle  
 - Solid brass body.  
*Delivered with 2 keys.*



MSA	Size	Kg
17.198	650 x 325 mm	0.290

Roll-up tool kit in leather imitation with 15 compartments, 1 flap and 1 strap.

PACKAGING



MSA	Shape	Compartments	Size	Kg
17.580	(1) Round	6	Ø 89 x 94 mm	0.141
17.581	(2) Rectangular	6	126 x 60 x 94 mm	0.174
17.582	(3) Square	4	80 x 80 x 94 mm	0.144

Stackable tray for spare parts with 1 transparent lid, set of 5 pieces (5 colours).

Material : ABS plastic (Acrylonitrile Butadiene Styrene).

Internal height 15 mm ; divisions height 4 mm.

Tray interior size :

(1) Ø 81 mm

(2) 120 x 53 mm

(3) 74 x 74 mm

Spare parts :

MSA	Item	Kg
17.580-A	(4) Transparent lid for MSA17.580	0.007
17.581-A	(5) Transparent lid for MSA17.581	0.008
17.582-A	(6) Transparent lid for MSA17.582	0.007

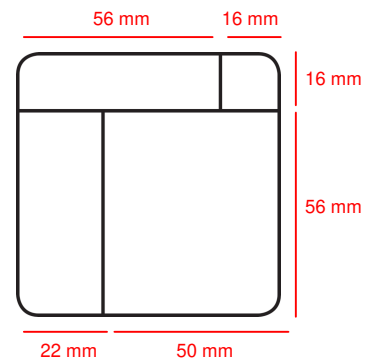
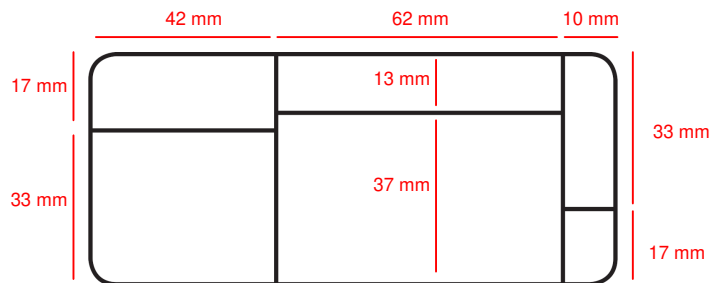
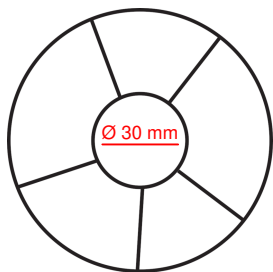

Glassine paper bags, ideal for very delicate items.

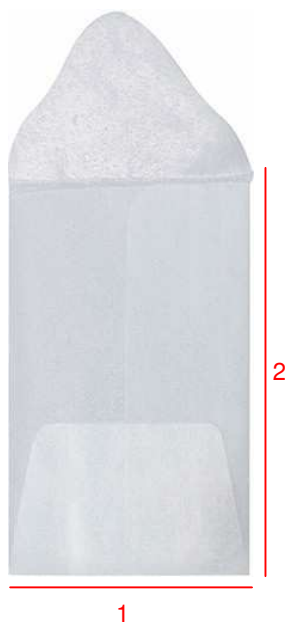

1000 pieces

MSA	Size 1 x 2	Quantity	Kg
17.710-3030	30 x 30 mm	1000	0.210
17.710-3636	36 x 36 mm	1000	0.267
17.710-4040	40 x 40 mm	1000	0.300
17.710-4545	45 x 45 mm	1000	0.355
17.710-5263	52 x 63 mm	1000	0.578
17.710-6010	60 x 100 mm	1000	0.650

Glassine paper bag 50 g/m2 without printing.  
Grooved execution cut and glued.

Plastic bags, seamless edges, ideal for small components.



100 pieces

MSA	Size 1 x 2	Quantity	Kg
17.703-40X65	40 x 65 mm	100	-
17.703-45X65	45 x 65 mm	100	-
17.703-45X250	45 x 250 mm	100	-
17.703-50X80	50 x 80 mm	100	0.035
17.703-50X150	50 x 150 mm	100	-
17.703-50X250	50 x 250 mm	100	-
17.703-55X250	55 x 250 mm	100	-
17.703-60X100	60 x 100 mm	100	-
17.703-80X150	80 x 150 mm	100	0.116
17.703-90X120	90 x 120 mm	100	-
17.703-100X150	100 x 150 mm	100	-
17.703-120X180	120 x 180 mm	100	-

Standard plastic bag, 0.05 mm thickness, without closing zip.

pressure seal bags.



2

100 pieces

1

MSA	Size 1 x 2	Quantity	Kg
17.713-050	50 x 70 mm (50 μ)	100	0.065
17.713-080	80 x 100 mm (100 μ)	100	0.225
17.713-100	100 x 150 mm (100 μ)	100	0.360
17.713-150	150 x 200 mm (100 μ)	100	0.720

Anti-corrosion green pressure seal bag.

Features :

- Material : polyethylene, transparent green
- Thickness 50 or 100 μ
- Corrosion protection, ideal for long term storage and overseas shipping
- Sealing pressure for easy opening and closing of the bag.



2

100 pieces

1

MSA	Size 1 x 2	Quantity	Kg
17.714-075	75 x 90 mm (75 μ)	100	0.150
17.714-090	90 x 100 mm (75 μ)	100	0.175
17.714-115	115 x 155 mm (75 μ)	100	0.500
17.714-160	160 x 220 mm (75 μ)	100	0.580
17.714-250	250 x 300 mm (75 μ)	100	1.250

Antistatic/ESD pink pressure seal bag.

Features :

- Material : polyethylene, transparent pink
- Thickness 75 μ
- Good electrostatic/ESD protection
- Ideal for storage and shipping of electronic components
- Sealing pressure for easy opening and closing of the bag.



2

100 pieces

1

MSA	Size 1 x 2	Quantity	Kg
17.715-075	75 x 90 mm (75 μ)	100	0.205
17.715-090	90 x 110 mm (75 μ)	100	0.132
17.715-115	115 x 155 mm (75 μ)	100	0.330

Black, opaque and UV-resistant pressure seal bag.

Features :

- Material : polyethylene, black opaque
- Thickness 75 μ
- UV-resistant
- Protection of age-sensitive goods
- Prevents yellowing of light-sensitive materials or embrittlement of rubber parts and plastic components due to exposure to light
- Sealing pressure for easy opening and closing of the bag.

**Minigrip® plastic bags.**

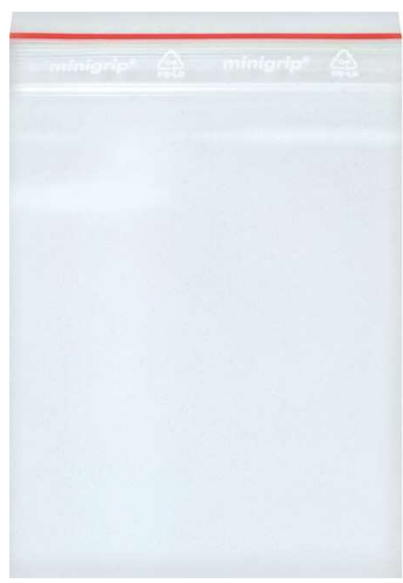

100 or 50 pieces

1

MSA	Size 1 x 2	Quantity	Kg
17.700-040	40 x 60 mm	100	0.046
17.700-050	50 x 75 mm	100	0.070
17.700-075	75 x 90 mm	100	0.104
17.700-090	90 x 110 mm	100	0.158
17.700-100	100 x 125 mm	100	0.185
17.700-115	115 x 155 mm	100	0.256
-	-	-	-
17.700-150	150 x 180 mm	50	0.504
17.700-160	160 x 220 mm	50	0.466
17.700-195	195 x 280 mm	50	0.682
17.700-200	200 x 250 mm	50	0.696
17.700-220	220 x 305 mm	50	0.830

Minigrip® plastic bag. Standard size, 0.05 mm thickness.  
Zip to easy open and close the bag. Its ingenious conception prevents from yielding under the weight of the contents.



100 or 50 pieces

1

MSA	Size 1 x 2	Quantity	Kg
17.701-040	40 x 60 mm	100	0.046
17.701-050	50 x 75 mm	100	0.070
17.701-075	75 x 90 mm	100	0.104
17.701-090	90 x 110 mm	100	0.316
17.701-100	100 x 125 mm	100	0.185
17.701-115	115 x 155 mm	100	0.256
17.701-150	150 x 180 mm	100	0.450
-	-	-	-
17.701-160	160 x 220 mm	50	0.466
17.701-200	200 x 250 mm	50	0.696
17.701-220	220 x 305 mm	50	0.700

Minigrip® plastic bag. Standard size, 0.05 mm thickness, with 3 white write-on sections for annotations.  
Zip to easy open and close the bag. Its ingenious conception prevents from yielding under the weight of the contents.

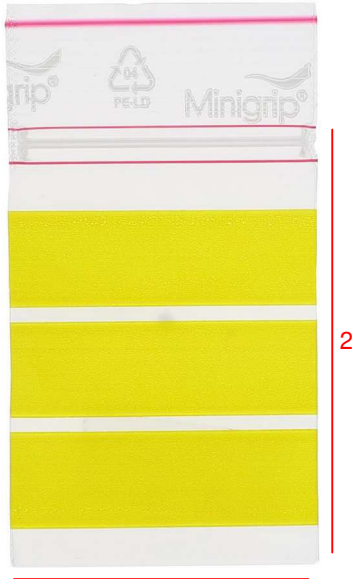

1000 pieces

1

MSA	Size 1 x 2	Quantity	Kg
17.704-040	40 x 60 mm	1000	0.625

Minigrip® plastic bag. Standard size, 0.06 mm thickness, with 3 yellow write-on sections for annotations and reinforced side welds. Zip to easy open and close the bag. Its ingenious conception prevents from yielding under the weight of the contents.

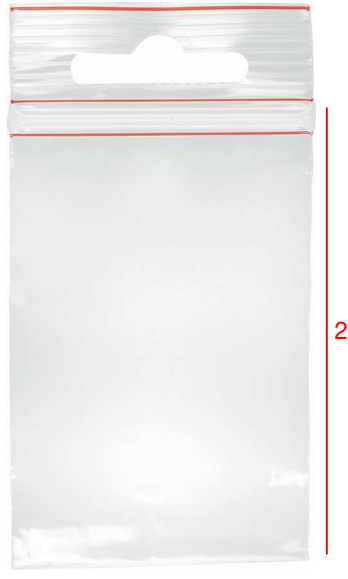

50 pieces

1

MSA	Size 1 x 2	Quantity	Kg
17.702-050	50 x 80 mm	50	0.035
17.702-090	90 x 170 mm	50	0.110

Minigrip® plastic bag, 0.05 mm thickness. Zip to easy open and close the bag. Top hole for hooking the bag on display.



Special plastic bag for chamber machines.



In a 500-piece bag :

MSA	Size 1 x 2	Quantity
17.706-250X500	250 x 500 mm	500
17.706-250X600	250 x 600 mm	500
17.706-260X450	260 x 450 mm	500
17.706-300X500	300 x 500 mm	500
17.706-300X600	300 x 600 mm	500
17.706-300X700	300 x 700 mm	500

Special plastic bag (PA/PE 20/70).

In a 1000-piece bag :

MSA	Size 1 x 2	Quantity
17.706-100X250	100 x 250 mm	1000
17.706-100X300	100 x 300 mm	1000
17.706-120X120	120 x 120 mm	1000
17.706-120X160	120 x 160 mm	1000
17.706-120X200	120 x 200 mm	1000
17.706-120X270	120 x 270 mm	1000
17.706-120X300	120 x 300 mm	1000
17.706-120X400	120 x 400 mm	1000
17.706-130X180	130 x 180 mm	1000
17.706-130X200	130 x 200 mm	1000
17.706-130X280	130 x 280 mm	1000
17.706-130X300	130 x 300 mm	1000
17.706-130X380	130 x 380 mm	1000
17.706-140X200	140 x 200 mm	1000
17.706-140X210	140 x 210 mm	1000
17.706-140X270	140 x 270 mm	1000
17.706-150X180	150 x 180 mm	1000
17.706-150X200	150 x 200 mm	1000
17.706-150X230	150 x 230 mm	1000
17.706-150X260	150 x 260 mm	1000
17.706-160X200	160 x 200 mm	1000
17.706-160X300	160 x 300 mm	1000
17.706-165X210	165 x 210 mm	1000
17.706-165X250	165 x 250 mm	1000
17.706-170X250	170 x 250 mm	1000
17.706-170X400	170 x 400 mm	1000

Special plastic bag (PA/PE 20/70).

MSA	Size 1 x 2	Quantity
17.706-180X230	180 x 230 mm	1000
17.706-180X240	180 x 240 mm	1000
17.706-180X250	180 x 250 mm	1000
17.706-180X260	180 x 260 mm	1000
17.706-180X280	180 x 280 mm	1000
17.706-180X350	180 x 350 mm	1000
17.706-200X220	200 x 220 mm	1000
17.706-200X250	200 x 250 mm	1000
17.706-200X300	200 x 300 mm	1000
17.706-200X350	200 x 350 mm	1000
17.706-200X400	200 x 400 mm	1000
17.706-200X500	200 x 500 mm	1000
17.706-200X600	200 x 600 mm	1000
17.706-220X300	220 x 300 mm	1000
17.706-225X350	225 x 350 mm	1000
17.706-230X380	230 x 380 mm	1000
17.706-250X280	250 x 280 mm	1000
17.706-250X300	250 x 300 mm	1000
17.706-250X350	250 x 350 mm	1000
17.706-250X400	250 x 400 mm	1000
17.706-260X350	260 x 350 mm	1000
17.706-270X300	270 x 300 mm	1000
17.706-300X300	300 x 300 mm	1000
17.706-300X350	300 x 350 mm	1000
17.706-300X400	300 x 400 mm	1000
17.706-320X320	320 x 320 mm	1000

Anti-dust dome.



MSA	Ø base	Dome size	Kg
17.600	90 mm	Ø 70 x 120 mm	0.133

Anti-dust dome with hook for watches and jewellery, with plastic base and transparent plastic dome.

Protection covers.



(1)

MSA		Size	Kg
17.015	(1)	310 x 120 x 50 mm	0.685
17.016		310 x 230 x 50 mm	0.870

Plexiglas anti-dust protection cover.

Dustproof cover.



PERF	Well	Kg
106	100 mm	0.070

Protection kit composed of one dustproof cover and one base with 6 divisions for small parts.

**Benzine cups and containers.**



MSA	Volume	Size	Kg
17.305	150 ml	Ø 98 x 81 mm	0.820

Stainless steel benzine container with safety lid for cleaning, removing grease and rust with with flammable or toxic liquids. In case of inflammation of the fluid, the copper fuse melts, the lid closes automatically and smothers the fire. The closed lid remains under pressure, prevents the spread of toxic fumes and protects the health of the staff. A special anchoring allows fixing the benzine container at the workplace, which prevents liquids from spilling.

*Delivered with a cooper fuse and a gasket for the lid.*

*Delivered without basket.*

*Base size : 100 x 140 x 5 mm.*

**Spare part :**

MSA	Item
17.305-F	Copper fuse

**Accessory :**

MSA	Item	Kg
17.305-P	Stainless steel basket, Ø 85 x 30 mm	0.075



MSA	Volume	Ø base	Size	Kg
17.306	40 ml	228.25	Ø 75 x 46 mm	0.293

Stainless steel benzine container with safety lid for cleaning, removing grease and rust with with flammable or toxic liquids.

In case of inflammation of the fluid, the copper fuse melts, the lid closes automatically and smothers the fire. The closed lid remains under pressure, prevents the spread of toxic fumes and protects the health of the staff.

*Delivered with a cooper fuse and an orange gasket for the lid.*

**Spare parts :**

MSA	Item
17.305-F	Copper fuse
17.306-J	Orange gasket



MSA	Volume	Size	Kg
17.317	50 ml	Ø 46 x 94 ml	0.115

Glass bottle for Epilames with pierced steel basket. For use with Episurf-Neo, EpiDrop and Moebius Fixodrop.

*Inner size of the basket : Ø 16 x height 8 mm.*

PACKAGING



MSA		Volume	Size	Kg	Ø plateau
17.314	(1)	180 ml	55 x 55 x 110 mm	0.067	
17.319	(2)	120 ml	55 x 55 x 80 mm	0.076	18.45 (10) 16.30

Antistatic solvent dispenser.  
Ideal for a wide range of applications in the watchmaking, electronics and medical industries.

The main advantages are :

- Dispenses clean
- Prevents evaporation and contamination
- Suitable for most liquids like solvents, degreasers, oils
- Easy use
- Reduces waste
- Prevents fumes, accident and spillage
- ESD safe (electrostatic discharge)
- Surface resistivity 107 to 109 Ohm
- No charge generation, no fire or explosion ignition risk
- The "anti-splash" function prevents splashing, liquid back-flow and eye protection
- Fluid pumped into the dish does not drip back into the bottle, keeping stored liquids uncontaminated.



MSA	Ø	Kg
17.300	60 mm	0.230
17.301	80 mm	0.400
17.302	100 mm	0.540
17.303	150 mm	1.030

Glass benzene cup for daily use of benzene, alcohol or other solutions.  
The lid with button prevents the entry of dust and the premature evaporation of solutions.



MSA	Size	Kg
17.318	Ø 36 x 36 mm	0.029

Glass benzene cup for benzene, alcohol or any other solutions.  
The lid with button prevents the entry of dust and the premature evaporation of solutions.

Inner size : Ø 32 x height 30 mm.  
Total height with button : 54 mm.



MSA	Ø	Kg
17.310	60 mm	0.205
17.311	80 mm	0.325
17.312	100 mm	0.505
17.313	150 mm	1.000

Glass benzene cup for daily use of benzene, alcohol or other solutions.  
The lid without button prevents the entry of dust and the premature evaporation of solutions.



MSA	External size	Kg
17.320-060	Ø 60 x 15 mm	0.055
17.320-080	Ø 80 x 15 mm	0.085
17.320-100	Ø 100 x 20 mm	0.145
17.320-150	Ø 150 x 25 mm	0.220

Glass dishes offer watchmakers an essential tool for the meticulous cleaning of watch parts.

These boxes ensure a sterile environment, protecting the parts from any contact with external dirt.

Their crystal-clear transparency allows complete visual control of the cleaning process, while the tight-fitting lids guarantee a reliable seal.



MSA	Volume	Kg
17.335	100 ml	0.017

Plastic burette with long tip nose.



MSA	Volume	Kg
17.336	50 ml	0.017

Plastic burette with dropper cap.

A burette enables small quantities of lubricant to be applied in the proper place.



(1)



(2)

MSA	Volume	Size	Kg
17.307	(1) 2 ml	Ø 14 x 26 mm	-
17.308	(2) 2 ml	Ø 14 x 26 mm	-

Glass storage bottle with yellow cap.

MSA17.307 : in amber glass.

MSA17.308 : in transparent glass.

Storage cabinet.



MSA	Kg
17.850	29.300

Storage cabinet with controlled humidity for components.  
 - Metallic cabinet with 2 doors lockable by key and 3 separation trays  
 - Humidity level automatically adjustable from 25 to 55% and controllable by indicator on the front panel.

*Features :*  
 External size : 80.0 x 83.5 x 45.5 cm  
 Internal size : 76.4 x 74.0 x 40.0 cm  
 Hygrometer : Analogic  
 Consumption : 12 Watts  
 Voltage : 220 V