

# 22

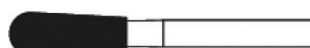

FRAISES HOROTEC®

22 - 2

ALÉSOIRS HOROTEC®

22 - 7

FRAISES

22 - 9

FRAISES DIAMANTÉES

22 - 19

FORETS

22 - 35

Fraises à pivots en métal dur.



ASSORTIMENT

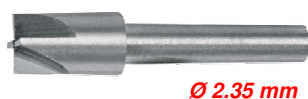

MSA	Dimensions	Kg
22.566	125 x 81 x 50 mm	0.260

Assortiment de 12 fraises à pivots en métal dur et 11 pivots en acier. Les pivots servent de guide en fonction du diamètre du trou et les fraises ébavurent la partie désirée. Les pivots sont interchangeable avec chaque fraise. Utilisation à main levée ou sur une potence.

Livré dans 1 coffret en bois.

\* Éléments dans l'assortiment MSA22.566

Fraises à pivots de rechange :

MSA	Élément	Kg
22.566-F100	Fraise à pivot, Ø 1.00 x L20 mm, angle 2°	0.001
22.566-F120 *	Fraise à pivot, Ø 1.20 x L20 mm, angle 2°	0.001
22.566-F150 *	Fraise à pivot, Ø 1.50 x L20 mm, angle 2°	0.001
22.566-F175 *	Fraise à pivot, Ø 1.75 x L20 mm, angle 2°	0.001
22.566-F180	Fraise à pivot, Ø 1.80 x L20 mm, angle 2°	0.001
22.566-F200 *	Fraise à pivot, Ø 2.00 x L20 mm, angle 2°	0.001
22.566-F225 *	Fraise à pivot, Ø 2.25 x L20 mm, angle 2°	0.001
22.566-F250 *	Fraise à pivot, Ø 2.50 x L20 mm, angle 2°	0.001
22.566-F275 *	Fraise à pivot, Ø 2.75 x L20 mm, angle 2°	0.001
22.566-F300 *	Fraise à pivot, Ø 3.00 x L20 mm, angle 2°	0.001
22.566-F325 *	Fraise à pivot, Ø 3.25 x L20 mm, angle 2°	0.002
22.566-F350 *	Fraise à pivot, Ø 3.50 x L20 mm, angle 2°	0.002
22.566-F375 *	Fraise à pivot, Ø 3.75 x L20 mm, angle 2°	0.002
22.566-F400 *	Fraise à pivot, Ø 4.00 x L20 mm, angle 2°	0.002

Pivots de rechange :

MSA	Élément	Kg
22.566-P040	Pivot, Ø 0.40 (a) x L24.50 mm	0.001
22.566-P050 *	Pivot, Ø 0.50 (a) x L24.50 mm	0.001
22.566-P060 *	Pivot, Ø 0.60 (a) x L24.50 mm	0.001
22.566-P070 *	Pivot, Ø 0.70 (a) x L24.50 mm	0.001
22.566-P080 *	Pivot, Ø 0.80 (a) x L24.50 mm	0.001
22.566-P090 *	Pivot, Ø 0.90 (a) x L24.50 mm	0.001
22.566-P100 *	Pivot, Ø 1.00 (a) x L24.50 mm	0.001
22.566-P110 *	Pivot, Ø 1.10 (a) x L24.50 mm	0.001
22.566-P120 *	Pivot, Ø 1.20 (a) x L24.50 mm	0.001
22.566-P130 *	Pivot, Ø 1.30 (a) x L24.50 mm	0.001
22.566-P140 *	Pivot, Ø 1.40 (a) x L24.50 mm	0.001
22.566-P150 *	Pivot, Ø 1.50 (a) x L24.50 mm	0.001

Porte-outils de rechange :

MSA	Élément	Kg
22.568 *	Porte-outil, Ø 4.70 x L90 mm	0.011

Fraises aux portées de vis, à 5 lèvres en métal dur.



ASSORTIMENT

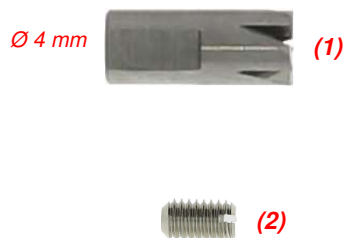

MSA	Dimensions	Kg
22.590	80 x 35 x 10 mm	0.060

Assortiment de 16 fraises à 5 lèvres en métal dur, permettant de retoucher la portée d'une vis pour un appui parfaitement plat.  
Les fraises sont fixées par une vis latérale pour un démontage facile.

\* Éléments dans l'assortiment MSA22.590

Pièces de rechange :

MSA	Élément	Kg
22.590-030	(1) Fraise Ø 0.30 mm	0.002
22.590-035	Fraise Ø 0.35 mm	0.002
22.590-040	Fraise Ø 0.40 mm	0.002
22.590-045	Fraise Ø 0.45 mm	0.002
22.590-050 *	Fraise Ø 0.500 mm	0.002
22.590-055 *	Fraise Ø 0.55 mm	0.002
22.590-060 *	Fraise Ø 0.60 mm	0.002
22.590-065 *	Fraise Ø 0.65 mm	0.002
22.590-070 *	Fraise Ø 0.70 mm	0.002
22.590-075 *	Fraise Ø 0.75 mm	0.002
22.590-080 *	Fraise Ø 0.80 mm	0.002
22.590-085 *	Fraise Ø 0.85 mm	0.002
22.590-090 *	Fraise Ø 0.90 mm	0.002
22.590-095 *	Fraise Ø 0.95 mm	0.002
22.590-100 *	Fraise Ø 1.00 mm	0.002
22.590-105	Fraise Ø 1.05 mm	0.002
22.590-110 *	Fraise Ø 1.10 mm	0.002
22.590-115	Fraise Ø 1.15 mm	0.002
22.590-120 *	Fraise Ø 1.20 mm	0.002
22.590-125	Fraise Ø 1.25 mm	0.002
22.590-130 *	Fraise Ø 1.30 mm	0.002
22.590-140 *	Fraise Ø 1.40 mm	0.002
22.590-150 *	Fraise Ø 1.50 mm	0.002
22.590-160	Fraise Ø 1.60 mm	0.002
22.590-170	Fraise Ø 1.70 mm	0.002
22.590-180	Fraise Ø 1.80 mm	0.002
22.590-190	Fraise Ø 1.90 mm	0.002
22.590-A	Plaque	0.036
22.590-C	(2) Vis latérale	0.001

Fraises à roulettes doubles.



ASSORTIMENT

MSA	Kg
22.560	0.030

Assortiment de 4 fraises à roulettes doubles en acier trempé.  
Diamètres des roulettes : 1.80-2.10 / 2.50-3.00 / 3.50-4.00 / 4.50-5.00 mm.  
Livré dans 1 pochette en plastique.

Pièces de rechange :

MSA	Élément	Kg
22.560-01	Fraise à roulettes doubles, Ø 1.80-2.10 mm	0.010
22.560-02	Fraise à roulettes doubles, Ø 2.50-3.00 mm	0.010
22.560-03	Fraise à roulettes doubles, Ø 3.50-4.00 mm	0.010
22.560-04	Fraise à roulettes doubles, Ø 4.50-5.00 mm	0.010

Fraises à roulette.



ASSORTIMENT

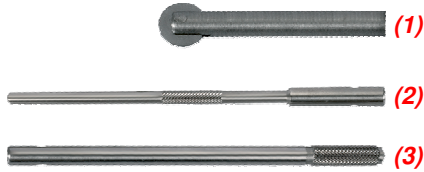

MSA	Dimensions	Kg
22.559	125 x 81 x 50 mm	0.265

Assortiment de 14 fraises à roulette coupantes en métal dur spécialement conçues pour dégager les moulures (gouttes, entrées de vis, etc.) montées sur manche conique.

Livré dans 1 coffret en bois avec :

- 2 porte-outils MSA22.564-030 et MSA22.564-047 (pour utilisation à main levée ou sur une potence)
- 14 fraises à roulettes (2 de chaque diamètre).

Pièces de rechange :

MSA	Élément	Kg
22.562-150	(1) Fraise à roulette MD Ø 1.50 mm, longueur 25 mm, angle 1°	0.001
22.562-200	Fraise à roulette MD Ø 2.00 mm, longueur 25 mm, angle 1°	0.001
22.562-250	Fraise à roulette MD Ø 2.50 mm, longueur 25 mm, angle 1°	0.001
22.562-300	Fraise à roulette MD Ø 3.00 mm, longueur 25 mm, angle 1°	0.001
22.562-350	Fraise à roulette MD Ø 3.50 mm, longueur 25 mm, angle 1°	0.001
22.562-400	Fraise à roulette MD Ø 4.00 mm, longueur 25 mm, angle 1°	0.001
22.562-450	Fraise à roulette MD Ø 4.50 mm, longueur 25 mm, angle 1°	0.001
22.564-030	(2) Porte-outils Ø 3.00 mm, longueur 100 mm Utilisation à main levée	0.008
22.564-047	(3) Porte-outils Ø 4.70 mm, longueur 90 mm Utilisation sur une potence	0.012



**ASSORTIMENT**

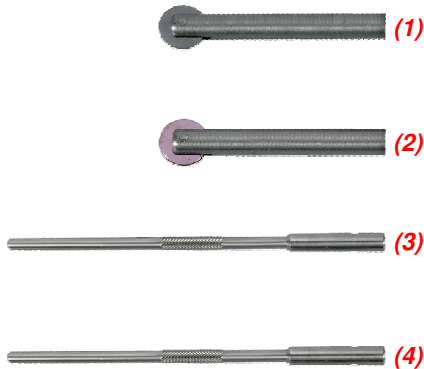

MSA	Dimensions	Kg
22.565	125 x 81 x 50 mm	0.290

Assortiment de 14 fraises à roulette contenant :  
 - 7 fraises à roulette coupantes en métal dur spécialement conçues pour dégager les moulures (gouttes, entrées de vis, etc.) montées sur manche conique  
 - 7 fraises à roulette rubis pour polir les moulures, montées sur manche conique. S'utilisent avec ou sans lubrifiant. L'état de surface rendu après utilisation des fraises en rubis garantit un résultat des plus soignés.  
 Les deux types de fraises à roulettes doivent être utilisés successivement (1ère : métal dur / 2ème : rubis) pour obtenir un poli parfait.  
 Livré dans 1 coffret en bois avec 2 porte-outils MSA22.564-030 et MSA22.564-047 (pour utilisation à main levée ou sur une potence).

**Pièces de rechange :**

MSA	Élément	Kg
22.562-150	(1) Fraise à roulette MD Ø 1.50 mm, longueur 25 mm, angle 1°	0.001
22.562-200	Fraise à roulette MD Ø 2.00 mm, longueur 25 mm, angle 1°	0.001
22.562-250	Fraise à roulette MD Ø 2.50 mm, longueur 25 mm, angle 1°	0.001
22.562-300	Fraise à roulette MD Ø 3.00 mm, longueur 25 mm, angle 1°	0.001
22.562-350	Fraise à roulette MD Ø 3.50 mm, longueur 25 mm, angle 1°	0.001
22.562-400	Fraise à roulette MD Ø 4.00 mm, longueur 25 mm, angle 1°	0.001
22.562-450	Fraise à roulette MD Ø 4.50 mm, longueur 25 mm, angle 1°	0.001
22.563-150	(2) Fraise à roulette rubis Ø 1.50 mm, longueur 25 mm, angle 1°	0.001
22.563-200	Fraise à roulette rubis Ø 2.00 mm, longueur 25 mm, angle 1°	0.001
22.563-250	Fraise à roulette rubis Ø 2.50 mm, longueur 25 mm, angle 1°	0.001
22.563-300	Fraise à roulette rubis Ø 3.00 mm, longueur 25 mm, angle 1°	0.001
22.563-350	Fraise à roulette rubis Ø 3.50 mm, longueur 25 mm, angle 1°	0.001
22.563-400	Fraise à roulette rubis Ø 4.00 mm, longueur 25 mm, angle 1°	0.001
22.563-450	Fraise à roulette rubis Ø 4.50 mm, longueur 25 mm, angle 1°	0.001
22.564-030	(3) Porte-outils Ø 3.00 mm, longueur 100 mm Utilisation à main levée	0.008
22.564-047	(4) Porte-outils Ø 4.70 mm, longueur 90 mm Utilisation sur une potence	0.012



Fraises à ébavurer et ébiser.



ASSORTIMENT

MSA	Dimensions	Kg
22.577	130 x 105 x 25 mm	0.123

Assortiment de 12 fraises à ébavurer et ébiser en acier trempé.  
Livré avec un manche en aluminium dans 1 boîte en plastique.

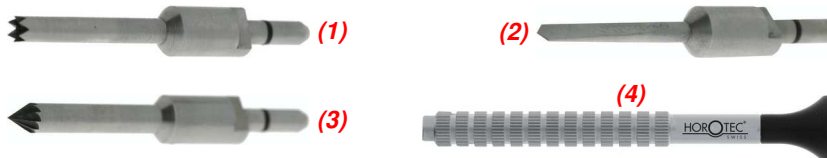

Pièces de rechange :

MSA	Élément	Kg
22.577-11	Fraise à ébavurer les bouts de vis, Ø 0.90 mm	0.002
22.577-12	Fraise à ébavurer les bouts de vis, Ø 1.30 mm	0.002
22.577-05	(1) Fraise à ébavurer les bouts de vis, Ø 2.50 mm	0.002
22.577-07	Fraise à ébavurer les bouts de vis (4 dents), Ø 3 mm	0.002
22.577-06	Fraise à ébavurer les bouts de vis, Ø 4 mm	0.003
22.577-08	Fraise à ébavurer les bouts de vis (4 dents), Ø 4 mm	0.003
-	-	-
22.577-09	Fraise à ébiser, Ø 1.00 mm	0.001
22.577-10	(2) Fraise à ébiser, Ø 2.00 mm	0.001
22.577-03	Fraise à ébiser, Ø 3.00 mm	0.002
22.577-04	Fraise à ébiser, Ø 4.00 mm	0.002
-	-	-
22.577-01	(3) Fraise conique, Ø 3.00 mm	0.002
22.577-02	Fraise conique, Ø 4.50 mm	0.003
-	-	-
22.577-A	(4) Manche	0.011



ASSORTIMENT

MSA	Dimensions	Kg
22.578	122 x 70 x 30 mm	0.126

Assortiment de 6 fraises doubles à ébavurer et ébiser en acier trempé (Hardness Rochwell 62-64).  
Livré avec un manche en aluminium éloxé rouge dans 1 coffret en bois.

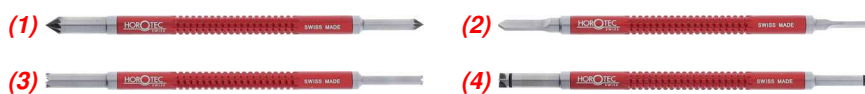

Pièces de rechange :

MSA	Élément	Kg
22.578-01	(1) Fraise double conique, Ø 3.00-4.50 mm	0.007
22.578-02	(2) Fraise double à ébiser, Ø 3.00-4.00 mm	0.006
22.578-05	Fraise double à ébiser, Ø 1.00-2.00 mm	0.002
22.578-03	(3) Fraise double à ébavurer les bouts de vis, Ø 2.50-4.00 mm	0.006
22.578-06	Fraise double à ébavurer les bouts de vis, Ø 0.90-1.30 mm	0.002
22.578-04	(4) Fraise double à 4 dents, Ø 3.00-4.00 mm	0.007

## Alésoirs à prise conique en métal dur.



## ASSORTIMENT

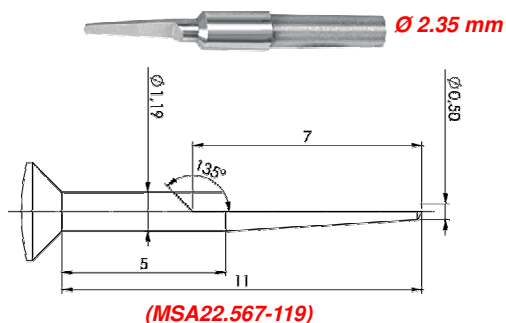

MSA	Dimensions	Kg
22.567	125 x 81 x 50 mm	0.250

Assortiment de 12 alésoirs à prise conique en métal dur pour la retouche de perçage (exemple : le trou d'aiguille).

Utilisation conseillée avec une potence.

Livré dans 1 coffret en bois.

\* Éléments dans l'assortiment MSA22.567

## Alésoirs de rechange :

MSA	Élément	Kg
22.567-053	Alésoir n° 53, Ø 0.53 x L 25 mm, angle 2°	0.001
22.567-054	Alésoir n° 54, Ø 0.54 x L 25 mm, angle 2°	0.001
22.567-055	Alésoir n° 55, Ø 0.55 x L 25 mm, angle 2°	0.001
22.567-069 *	Alésoir n° 69, Ø 0.69 x L 25 mm, angle 2°	0.001
22.567-079 *	Alésoir n° 79, Ø 0.79 x L 25 mm, angle 2°	0.001
22.567-089 *	Alésoir n° 89, Ø 0.89 x L 25 mm, angle 2°	0.001
22.567-099 *	Alésoir n° 99, Ø 0.99 x L 25 mm, angle 2°	0.001
22.567-109 *	Alésoir n° 109, Ø 1.09 x L 25 mm, angle 2°	0.001
22.567-119 *	Alésoir n° 119, Ø 1.19 x L 25 mm, angle 2°	0.001
22.567-129 *	Alésoir n° 129, Ø 1.29 x L 25 mm, angle 2°	0.001
22.567-139 *	Alésoir n° 139, Ø 1.39 x L 25 mm, angle 2°	0.001
22.567-149 *	Alésoir n° 149, Ø 1.49 x L 25 mm, angle 2°	0.001
22.567-159 *	Alésoir n° 159, Ø 1.59 x L 25 mm, angle 2°	0.001
22.567-169 *	Alésoir n° 169, Ø 1.69 x L 25 mm, angle 2°	0.001
22.567-179 *	Alésoir n° 179, Ø 1.79 x L 25 mm, angle 2°	0.001

## Porte-outils de rechange :

MSA	Élément	Kg
22.568 *	Porte-outil, Ø 4.70 x L90 mm	0.011



**ASSORTIMENT**

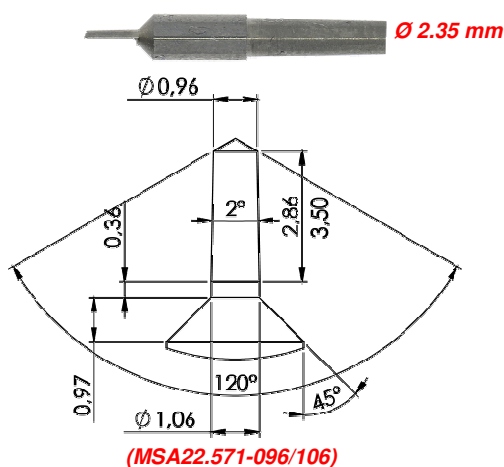

MSA	Dimensions	Kg
22.571	145 x 75 x 40 mm	0.250

Assortiment de 12 alésoirs en métal dur à prise conique pour la retouche de perçage (exemple : le trou d'aiguille).  
Utilisation conseillée avec une potence.  
Livré dans 1 coffret en bois.

\* Éléments dans l'assortiment MSA22.571

**Alésoirs de rechange :**

MSA	Élément	Kg
22.571-032/042	Alésoir Ø 0.32...0.42 x L19.50 mm, angle 2°	0.001
22.571-040/050	Alésoir Ø 0.40...0.50 x L19.50 mm, angle 2°	0.001
22.571-048/058	Alésoir Ø 0.48...0.58 x L19.50 mm, angle 2°	0.001
22.571-056/066	Alésoir Ø 0.56...0.66 x L19.50 mm, angle 2°	0.001
22.571-064/074	Alésoir Ø 0.64...0.74 x L19.50 mm, angle 2°	0.001
22.571-072/082	Alésoir Ø 0.72...0.82 x L19.50 mm, angle 2°	0.001
22.571-080/090	Alésoir Ø 0.80...0.90 x L19.50 mm, angle 2°	0.001
22.571-088/098	Alésoir Ø 0.88...0.98 x L19.50 mm, angle 2°	0.001
22.571-096/106	Alésoir Ø 0.96...1.06 x L19.50 mm, angle 2°	0.001
22.571-104/114	Alésoir Ø 1.04...1.14 x L19.50 mm, angle 2°	0.001
22.571-112/122	Alésoir Ø 1.12...1.22 x L19.50 mm, angle 2°	0.001
22.571-120/130	Alésoir Ø 1.20...1.30 x L19.50 mm, angle 2°	0.001

**Porte-outils de rechange :**

MSA	Élément	Kg
22.568	Porte-outil, Ø 4.70 x L90 mm	0.011



Fraise en métal dur.



MSA	Longueur totale	Kg
22.558-270	25 mm (5 mm)	0.001

Fraise en métal dur pour pieds de cadran.  
- Corps Ø 3.00 ; coupe Ø 2.70 mm.

Fraises en carbure de tungstène, tige Ø 2.35 mm.

Exemple de commande : MSA22.400-xxx  
(Extensions 3 chiffres = Ø tête mm)

MSA22.400-002 = Ø tête 0.20 mm  
MSA22.400-027 = Ø tête 2.70 mm

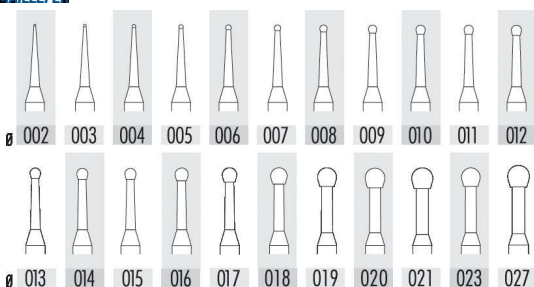

MSA	Type	Forme	Ø tête	Kg
22.400-002	123	Ronde	0.20 mm	0.001
...	...	...	...	...
22.400-027	123	Ronde	2.70 mm	0.001

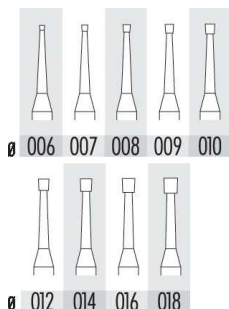

MSA	Type	Forme	Ø tête	Kg
22.401-006	124	Cône inversé	0.60 mm	0.001
...	...	...	...	...
22.401-018	124	Cône inversé	1.80 mm	0.001

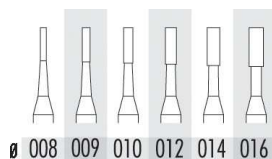

MSA	Type	Forme	Ø tête	Kg
22.404-008	129	Cylindrique	0.80 mm	0.001
...	...	...	...	...
22.404-016	129	Cylindrique	1.60 mm	0.001

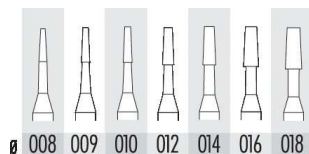

MSA	Type	Forme	Ø tête	Kg
22.405-008	130	Cône	0.80 mm	0.001
...	...	...	...	...
22.405-018	130	Cône	1.80 mm	0.001

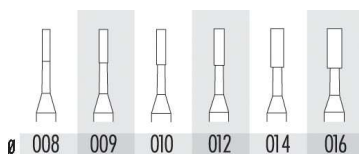

MSA	Type	Forme	Ø tête	Kg
22.407-008	137	Cylindrique	0.80 mm	0.001
...	...	...	...	...
22.407-016	137	Cylindrique	1.60 mm	0.001



# FRAISES

Exemple de commande : MSA22.400-xxx  
(Extensions 3 chiffres = Ø tête mm)

MSA22.400-008 = Ø tête 0.80 mm  
MSA22.400-023 = Ø tête 2.30 mm

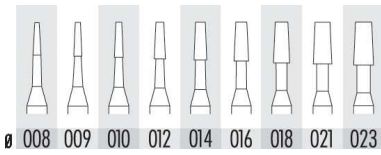

MSA	Type	Forme	Ø tête	Kg
22.408-008	138	Cône	0.80 mm	0.001
...	...	...	...	...
22.408-023	138	Cône	2.30 mm	0.001



MSA	Type	Longueur	Ø tête	Kg
22.450	Standard	12.20 mm	6 mm	0.002
22.450-F	Fin	12.20 mm	6 mm	0.002

## Fraises en acier à outils, tige Ø 2.35 mm.

Exemple de commande : MSA22.300-xxx  
(Extensions 3 chiffres = Ø tête mm)

MSA22.300-003 = Ø tête 0.30 mm  
MSA22.300-100 = Ø tête 10.00 mm

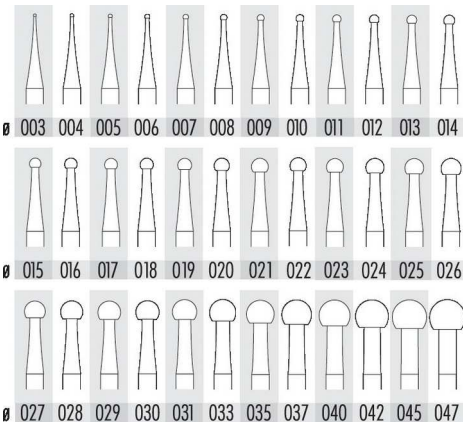

MSA	Type	Forme	Ø tête	Kg
22.300-003	23	Ronde	0.30 mm	0.001
...	...	...	...	...
22.300-100	23	Ronde	10.00 mm	0.001

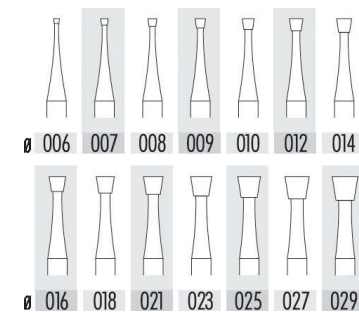
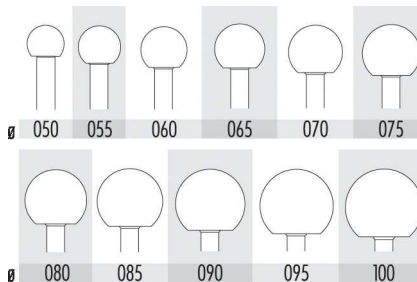

MSA	Type	Forme	Ø tête	Kg
22.301-006	24	Cône inversé	0.60 mm	0.001
...	...	...	...	...
22.301-029	24	Cône inversé	2.90 mm	0.001

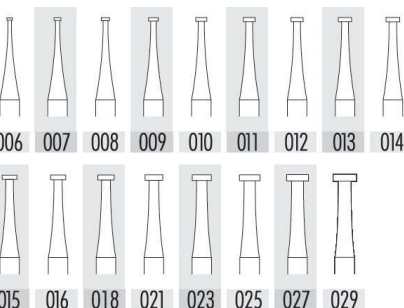

MSA	Type	Forme	Ø tête	Kg
22.302-006	25	Roue	0.60 mm	0.001
...	...	...	...	...
22.302-029	25	Roue	2.90 mm	0.001



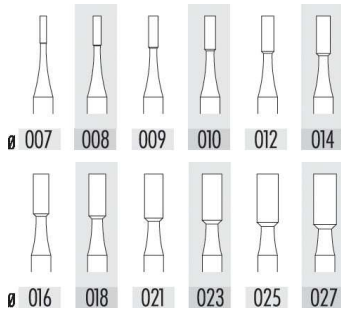

MSA	Type	Forme	Ø tête	Kg
22.303-007	26	Cylindrique	0.70 mm	0.001
...	...	...	...	...
22.303-027	26	Cylindrique	2.70 mm	0.001

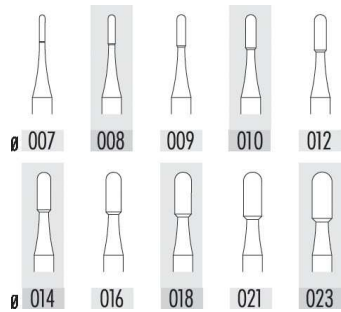

MSA	Type	Forme	Ø tête	Kg
22.304-007	28	Cylindrique	0.70 mm	0.001
...	...	...	...	...
22.304-023	28	Cylindrique	2.30 mm	0.001

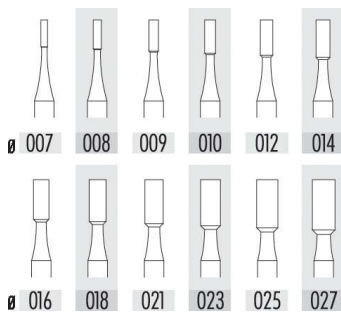

MSA	Type	Forme	Ø tête	Kg
22.312-007	29	Cylindrique	0.70 mm	0.001
...	...	...	...	...
22.312-027	29	Cylindrique	2.70 mm	0.001

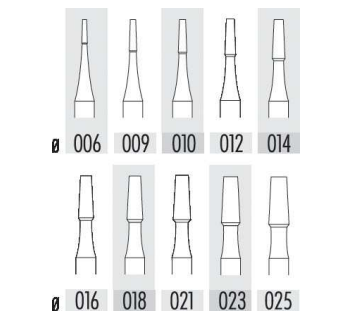

MSA	Type	Forme	Ø tête	Kg
22.305-009	30	Cône	0.90 mm	0.001
...	...	...	...	...
22.305-025	30	Cône	2.50 mm	0.001

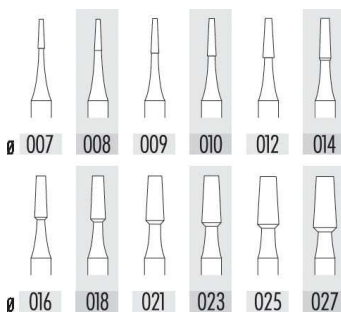

MSA	Type	Forme	Ø tête	Kg
22.313-007	31	Cône	0.70 mm	0.001
...	...	...	...	...
22.313-027	31	Cône	2.70 mm	0.001



# FRAISES

Exemple de commande : MSA22.306-xxx  
(Extensions 3 chiffres = Ø tête mm)

MSA22.306-006 = Ø tête 0.60 mm  
MSA22.308-027 = Ø tête 2.70 mm

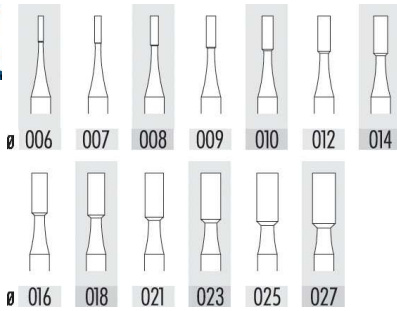

MSA	Type	Forme	Ø tête	Kg
22.306-006	34	Cylindrique	0.60 mm	0.001
...	...	...	...	...
22.306-027	34	Cylindrique	2.70 mm	0.001

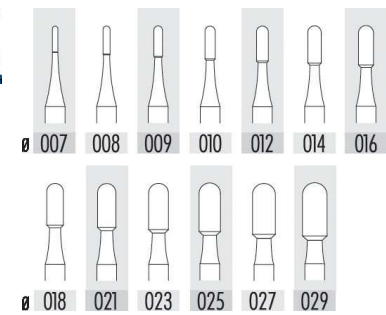

MSA	Type	Forme	Ø tête	Kg
22.308-007	36	Cylindrique	0.70 mm	0.001
...	...	...	...	...
22.308-029	36	Cylindrique	2.90 mm	0.001

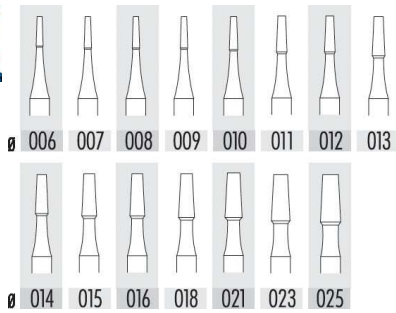

MSA	Type	Forme	Ø tête	Kg
22.309-006	38	Cône	0.60 mm	0.001
...	...	...	...	...
22.309-025	38	Cône	2.50 mm	0.001

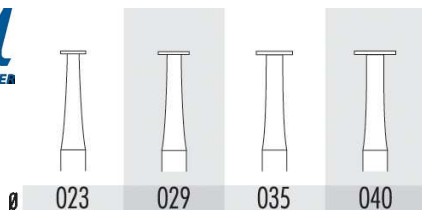

MSA	Type	Forme	Ø tête	Kg
22.311-023	45	Roue	2.30 mm	0.001
...	...	...	...	...
22.311-040	45	Roue	4.00 mm	0.001

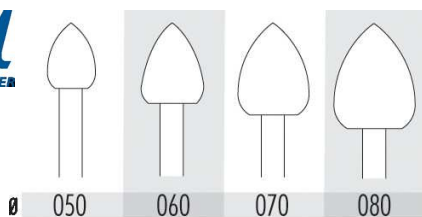

MSA	Type	Forme	Ø tête	Kg
22.211-050	83	Ogive	5.00 mm	0.001
...	...	...	...	...
22.211-080	83	Ogive	8.00 mm	0.001



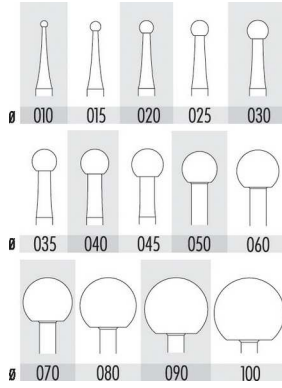

MSA	Type	Forme	Ø tête	Kg
22.100-010	A	Ronde fine	1.00 mm	0.001
...	...	...	...	...
22.100-100	A	Ronde fine	10.00 mm	0.001

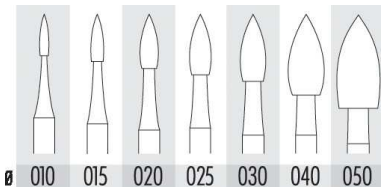

MSA	Type	Forme	Ø tête	Kg
22.102-010	G	Flamme fine	1.00 mm	0.001
...	...	...	...	...
22.102-050	G	Flamme fine	5.00 mm	0.001

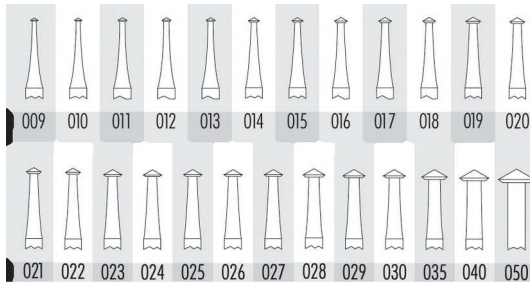

MSA	Type	Forme	Ø tête	Kg
22.103-009	H	Double cône 120°	0.90 mm	0.001
...	...	...	...	...
22.103-050	H	Double cône 120°	5.00 mm	0.001

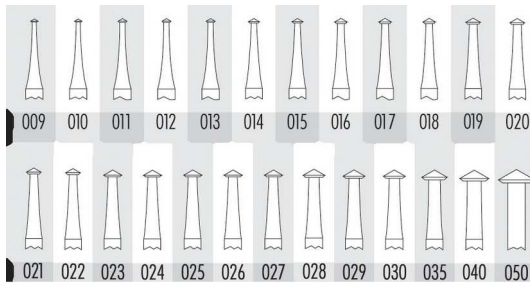

MSA	Type	Forme	Ø tête	Kg
22.121-005	HB	Double cône 70°	0.50 mm	0.001
...	...	...	...	...
22.121-037	HB	Double cône 70°	3.70 mm	0.001

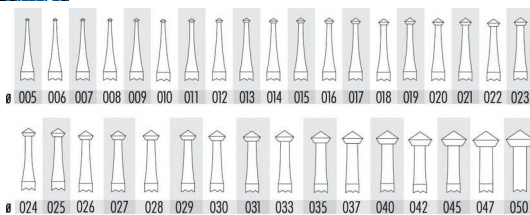

MSA	Type	Forme	Ø tête	Kg
22.104-005	HD	Double cône 90°	0.50 mm	0.001
...	...	...	...	...
22.104-050	HD	Double cône 90°	5.00 mm	0.001





Exemple de commande : MSA22.105-xxx  
(Extensions 3 chiffres = Ø tête mm)

MSA22.105-009 = Ø tête 0.90 mm  
MSA22.105-100 = Ø tête 10.00 mm

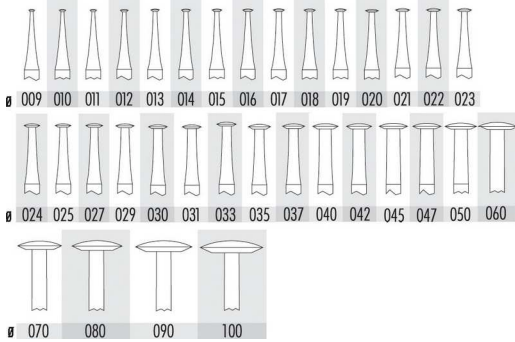

MSA	Type	Forme	Ø tête	Kg
22.105-009	HH	Lentille	0.90 mm	0.001
...	...	...	...	...
22.105-100	HH	Lentille	10.00 mm	0.001

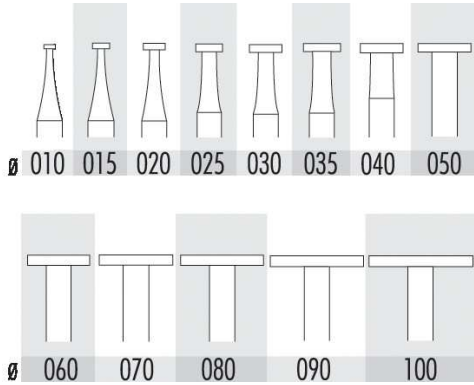

MSA	Type	Forme	Ø tête	Kg
22.107-010	K	Roue	1.00 mm	0.001
...	...	...	...	...
22.107-100	K	Roue	10.00 mm	0.001

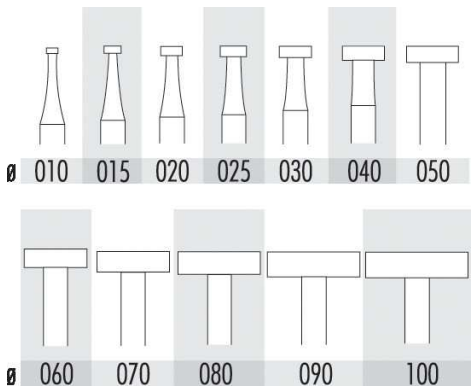
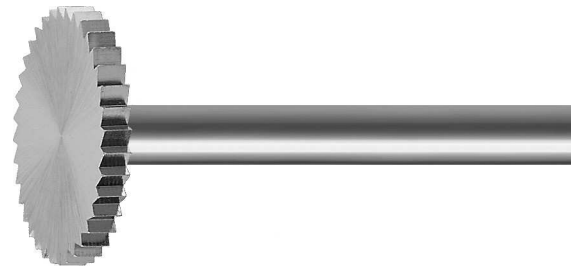

MSA	Type	Forme	Ø tête	Kg
22.110-010	KK	Roue	1.00 mm	0.001
...	...	...	...	...
22.110-100	KK	Roue	10.00 mm	0.001

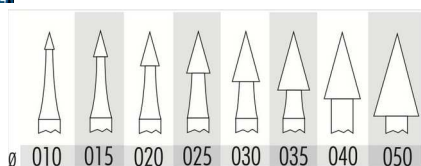

MSA	Type	Forme	Ø tête	Kg
22.112-010	N	Cône 30°	1.00 mm	0.001
...	...	...	...	...
22.112-050	N	Cône 30°	5.00 mm	0.001



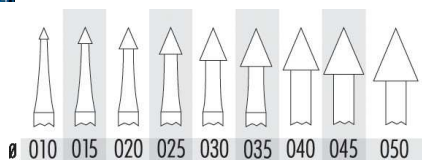

MSA	Type	Forme	Ø tête	Kg
22.113-010	NN (fine)	Cône 45°	1.00 mm	0.001
...	...	...	...	...
22.113-050	NN (fine)	Cône 45°	5.00 mm	0.001

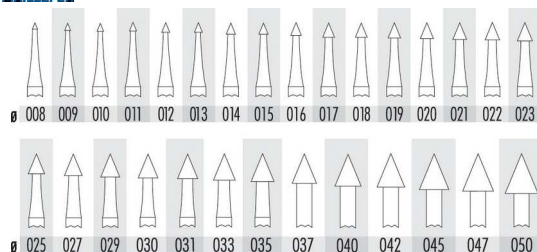

MSA	Type	Forme	Ø tête	Kg
22.123-008	NN (grossier)	Cône 45°	0.80 mm	0.001
...	...	...	...	...
22.123-050	NN (grossier)	Cône 45°	5.00 mm	0.001

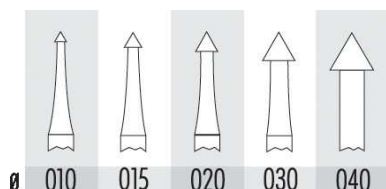

MSA	Type	Forme	Ø tête	Kg
22.114-010	O	Cône 60°	1.00 mm	0.001
...	...	...	...	...
22.114-040	O	Cône 60°	4.00 mm	0.001

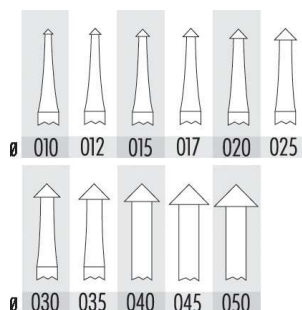

MSA	Type	Forme	Ø tête	Kg
22.115-010	P	Cône 90°	1.00 mm	0.001
...	...	...	...	...
22.115-050	P	Cône 90°	5.00 mm	0.001

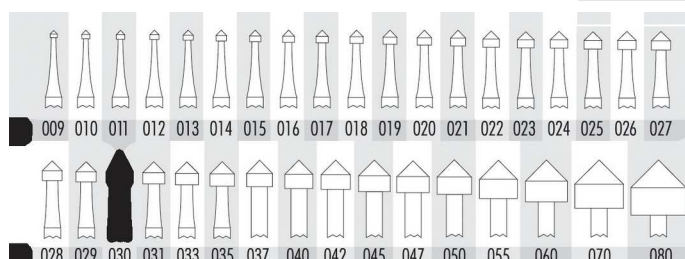
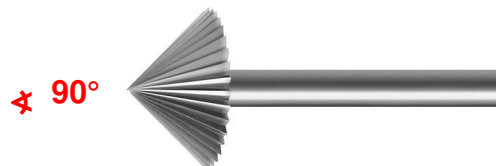

MSA	Type	Forme	Ø tête	Kg
22.116-009	Q	Cylindrique pointue	0.90 mm	0.001
...	...	...	...	...
22.116-080	Q	Cylindrique pointue	8.00 mm	0.001



# FRAISES

Exemple de commande : MSA22.117-xxx  
(Extensions 3 chiffres = Ø tête mm)

MSA22.117-010 = Ø tête 0.10 mm  
MSA22.117-100 = Ø tête 10.00 mm

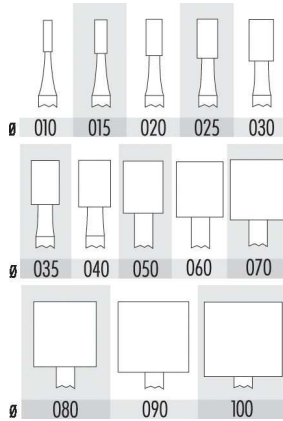

MSA	Type	Forme	Ø tête	Kg
22.117-010	R	Cylindrique	1.00 mm	0.001
...	...	...	...	...
22.117-100	R	Cylindrique	10.00 mm	0.001

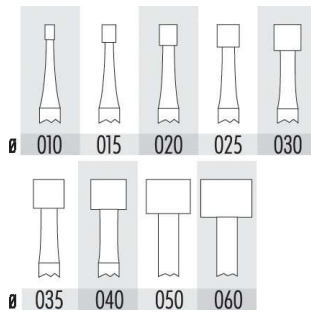

MSA	Type	Forme	Ø tête	Kg
22.122-010	RR	Cylindrique	1.00 mm	0.001
...	...	...	...	0.001
22.122-060	RR	Cylindrique	6.00 mm	0.001

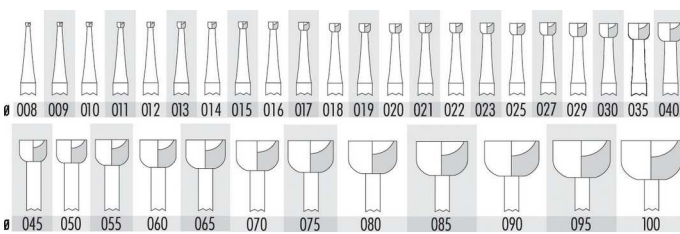

MSA	Type	Forme	Ø tête	Kg
22.119-008	S	Cylindrique creuse	0.80 mm	0.001
...	...	...	...	...
22.119-100	S	Cylindrique creuse	10.00 mm	0.001

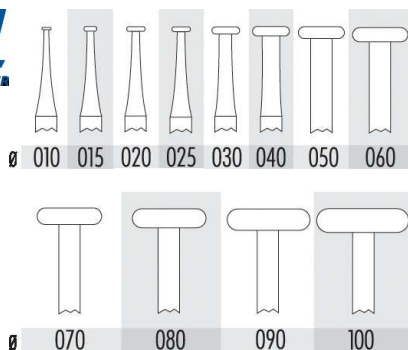

MSA	Type	Forme	Ø tête	Kg
22.118-010	Y	Roue biseautée	1.00 mm	0.001
...	...	...	...	0.001
22.118-100	Y	Roue biseautée	10.00 mm	0.001



Assortiments de 24 fraises en acier à outils, livrés dans 1 boîte en plastique.



ASSORTIMENT

MSA	Type	Ø tige	Kg
22.500	1235	2.35 mm	0.090

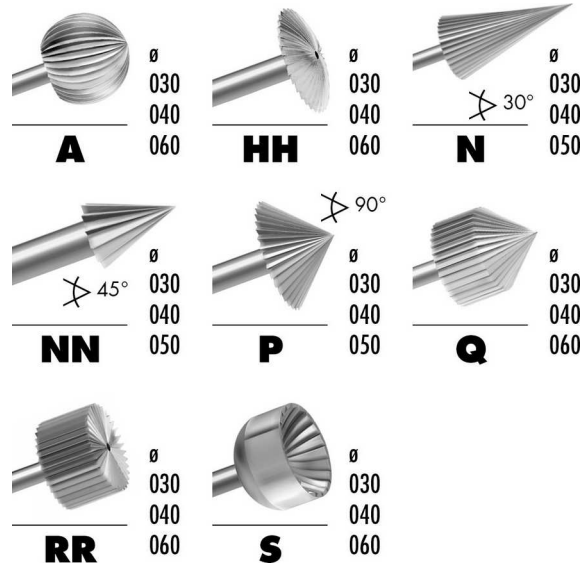

ASSORTIMENT

MSA	Type	Ø tige	Kg
22.510	3235	2.35 mm	0.090

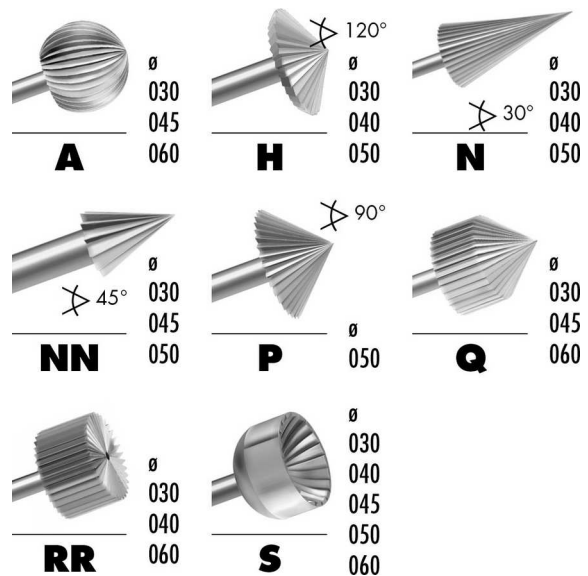



ASSORTIMENT

MSA	Type	Ø tige	Kg
22.515	4235	2.35 mm	0.090

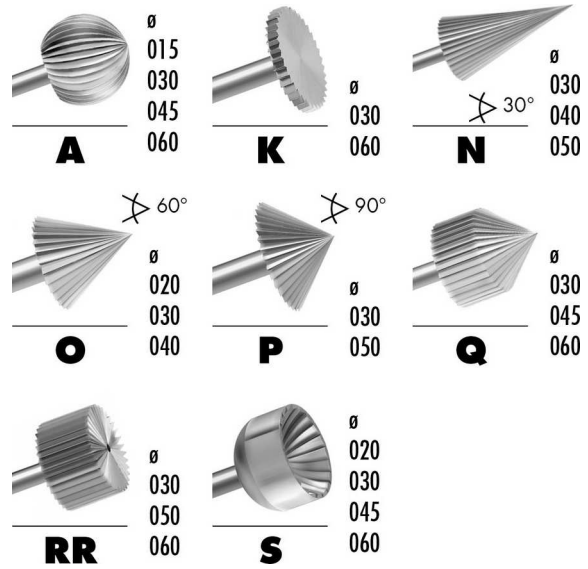

ASSORTIMENT

MSA	Type	Ø tige	Kg
22.520	8235	2.35 mm	0.090

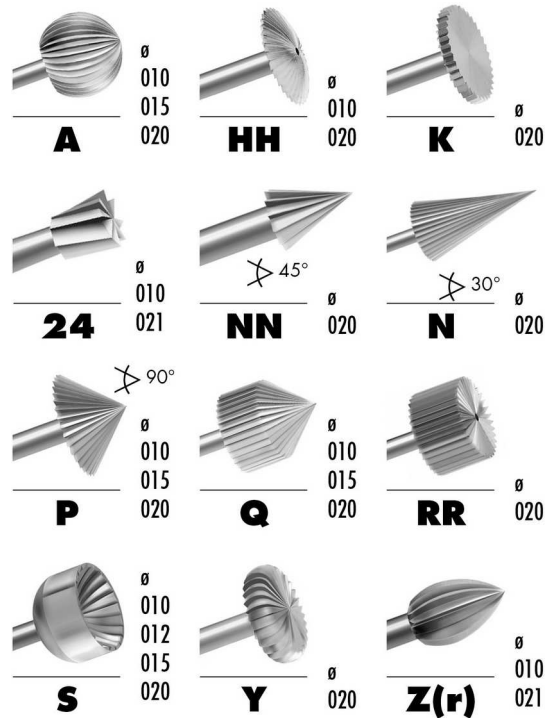



Exemple de commande : MSA22.723-xxxx  
(Extensions 3 chiffres + 1 lettre = Ø tête mm + grain)

MSA22.723-016A = Ø 1.60 mm + grain super grossier  
MSA22.723-023G = Ø 2.30 mm + grain ultra grossier

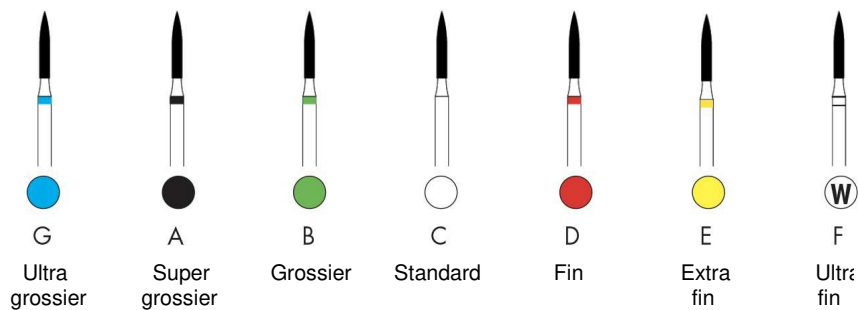
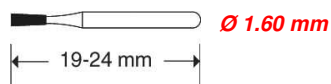

T. 368

MSA	Ø tête 1.6 mm	Ø tête 2.1 mm	Ø tête 2.3 mm
22.723	-	-	-023G
22.723	-016A	-021A	-023A
22.723	-016B	-021B	-023B
22.723	-016C	-021C	-023C
22.723	-016D	-021D	-023D
22.723	-016E	-021E	-023E
22.723	-016F	-021F	-023F
-	-	-	-
L mm	3.50	5.00	5.00

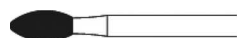

T. A368

MSA	Ø tête 2.3 mm
22.739	-023B
22.739	-023C
22.739	-023D
22.739	-023E
-	-
L mm	5.00



T. A369

MSA	Ø tête 2.3 mm
22.734	-023A
22.734	-023B
22.734	-023C
22.734	-023D
22.734	-023E
-	-
L mm	5.70



T. 379

MSA	Ø tête 1.4 mm	Ø tête 1.8 mm	Ø tête 2.3 mm
22.722	-	-	-023G
22.722	-014A	-018A	-023A
22.722	-014B	-018B	-023B
22.722	-014C	-018C	-023C
22.722	-014D	-018D	-023D
22.722	-014E	-018E	-023E
22.722	-014F	-018F	-023F
-	-	-	-
L mm	3.00	3.50	4.50

# FRAISES DIAMANTÉES

Exemple de commande : MSA22.735-xxxx  
(Extensions 3 chiffres + 1 lettre = Ø tête mm + grain)

MSA22.735-016C = Ø 1.60 mm + grain standard  
MSA22.735-016E = Ø 1.60 mm + grain extra fin

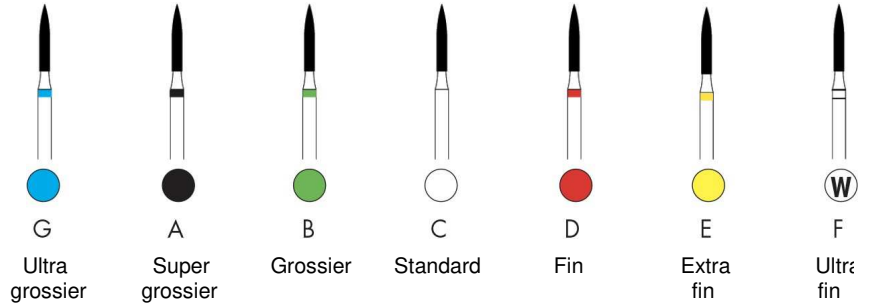
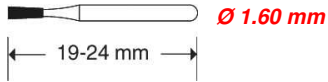

T. 392

MSA	Ø tête 1.6 mm
22.735	-016C
22.735	-016D
22.735	-016E
-	-
L mm	5.00

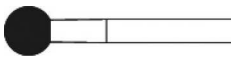

T. 801

MSA	Ø tête 0.8 mm	Ø tête 0.9 mm	Ø tête 1.0 mm	Ø tête 1.2 mm	Ø tête 1.4 mm	Ø tête 1.6 mm	Ø tête 1.8 mm	Ø tête 2.1 mm	Ø tête 2.3 mm	Ø tête 2.7 mm	Ø tête 2.9 mm	Ø tête 3.5 mm
22.701	-	-	-	-	-	-016G	-018G	-	-023G	-	-	-
22.701	-	-	-010A	-012A	-014A	-016A	-018A	-021A	-023A	-027A	-029A	-035A
22.701	-008B	-009B	-010B	-012B	-014B	-016B	-018B	-021B	-023B	-027B	-029B	-035B
22.701	-008C	-009C	-010C	-012C	-014C	-016C	-018C	-021C	-023C	-027C	-029C	-035C
22.701	-008D	-	-010D	-012D	-014D	-016D	-018D	-021D	-023D	-027D	-029D	-035D
22.701	-008E	-	-	-012E	-014E	-	-018E	-021E	-023E	-027E	-029E	-035E
22.701	-008F	-	-	-	-014F	-	-018F	-	-023F	-	-029F	-035F



T. A801

MSA	Ø tête 1.6 mm
22.732	-016B
22.732	-016C
22.732	-016D



T. 802

MSA	Ø tête 0.9 mm	Ø tête 1.0 mm	Ø tête 1.2 mm	Ø tête 1.4 mm	Ø tête 1.6 mm	Ø tête 1.8 mm	Ø tête 2.1 mm	Ø tête 2.3 mm
22.702	-	-	-	-	-	-018A	-	-
22.702	-009B	-010B	-012B	-014B	-016B	-018B	-	-023B
22.702	-009C	-010C	-012C	-014C	-016C	-018C	021C	-023C
22.702	-	-	-	-014D	-	-	-	-
22.702	-	-	-	-	-	-018E	-	-
-	-	-	-	-	-	-	-	-
L mm	2.00	2.00	3.00	3.00	3.00	3.50	4.00	4.50

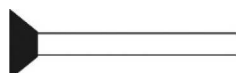

T. 805

MSA	Ø tête 0.9 mm	Ø tête 1.0 mm	Ø tête 1.2 mm	Ø tête 1.4 mm	Ø tête 1.6 mm	Ø tête 1.8 mm	Ø tête 2.3 mm	Ø tête 4.0 mm	Ø tête 5.0 mm
22.703	-	-	-	-	-016A	-018A	-	-	-
22.703	-009B	-010B	-012B	-014B	-016B	-018B	-023B	-	-
22.703	-009C	-010C	-012C	-014C	-016C	-018C	-023C	-040C	-050C
22.703	-	-010D	-012D	-014D	-016D	-	-	-	-
-	-	-	-	-	-	-	-	-	-
L mm	↔ 1.00	1.00	1.50	1.50	1.50	1.50	2.00	1.50	2.00

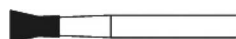

T. 806

MSA	Ø tête 0.9 mm	Ø tête 1.0 mm	Ø tête 1.2 mm	Ø tête 1.4 mm	Ø tête 1.6 mm	Ø tête 1.8 mm	Ø tête 2.3 mm
22.704	-	-	-	-014A	-	-	-
22.704	-	-010B	-012B	-014B	-016B	-018B	-
22.704	-009C	-010C	-012C	-014C	-016C	-018C	-023C
-	-	-	-	-	-	-	-
L mm	↔ 2.00	2.00	3.00	3.00	3.00	3.00	3.50



T. 807

MSA	Ø tête 1.0 mm	Ø tête 1.2 mm	Ø tête 1.6 mm	Ø tête 1.8 mm
22.705	-	-012A	-	-
22.705	-010B	-012B	-016B	-018B
22.705	-010C	-012C	-016C	-018C
-	-	-	-	-
L mm	↔ 3.00	3.50	4.00	5.00



T. 808

MSA	Ø tête 1.8 mm	Ø tête 2.3 mm
22.708	-018C	-023C
-	-	-
L mm	↔ 0.70	0.80



T. 809

MSA	Ø tête 1.8 mm	Ø tête 2.3 mm
22.709	-018C	-023C
-	-	-
L mm	↔ 2.00	2.50



T. 810

MSA	Ø tête 4.0 mm	Ø tête 5.0 mm
22.710	-040C	-050C
-	-	-
L mm	↔ 0.20	0.20



T. 811

MSA	Ø tête 3.1 mm	Ø tête 4.0 mm
22.714	-031A	-
22.714	-031B	-040B
22.714	-031C	-040C
-	-	-
L mm	↔ 4.00	6.00

# FRAISES DIAMANTÉES

Exemple de commande : MSA22.711-xxxx  
(Extensions 3 chiffres + 1 lettre = Ø tête mm + grain)

MSA22.711-040C = Ø 4.00 mm + grain standard

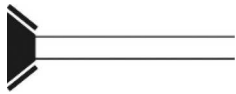
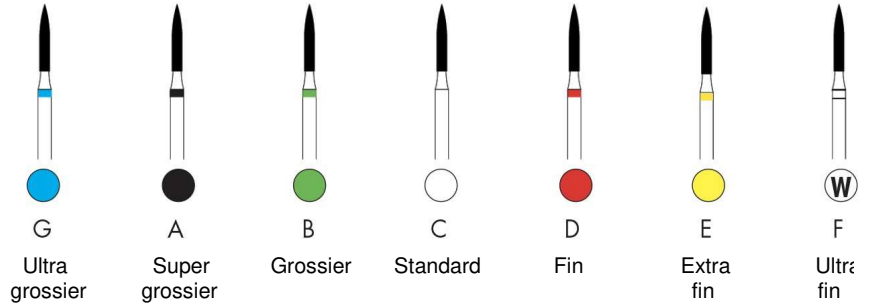
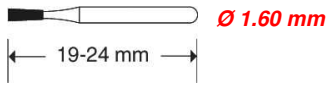

T. 812

MSA		Ø tête 4.0 mm	Ø tête 5.0 mm
22.711	□	-040C	-050C
-		-	-
L mm	↔	1.50	2.00



T. 813

MSA		Ø tête 1.0 mm	Ø tête 1.4 mm	Ø tête 1.6 mm
22.712	■	-	-014A	-016A
22.712	■	-	-014B	-016B
22.712	□	-010C	-014C	-016C
22.712	■	-	-014D	-016D
-		-	-	-
L mm	↔	1.50	1.60	1.90

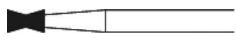

T. 813L

MSA		Ø tête 1.4 mm	Ø tête 1.6 mm
22.713	■	-014A	-016A
22.713	■	-014B	-016B
22.713	□	-014C	-016C
22.713	■	-014D	-016D
-		-	-
L mm	↔	3.00	3.00

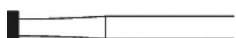

T. 815

MSA		Ø tête 1.2 mm	Ø tête 1.6 mm	Ø tête 1.8 mm	Ø tête 2.3 mm
22.715	■	-012B	-016B	-	-
22.715	□	-012C	-016C	-018C	-023C
-		-	-	-	-
L mm	↔	0.50	0.70	0.70	0.80

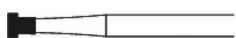

T. 816

MSA		Ø tête 1.2 mm	Ø tête 1.6 mm	Ø tête 1.8 mm
22.716	□	-012C	-016C	-018C
-		-	-	-
L mm	↔	1.50	1.80	2.00



T. 817

MSA		Ø tête 3.3 mm	Ø tête 4.0 mm	Ø tête 5.0 mm
22.737	■	-033B	-040B	-050B
22.737	□	-033C	-040C	-050C
-	-	-	-	-
L mm	↔	0.70	0.70	0.70

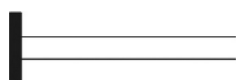

T. 818

MSA		Ø tête 3.3 mm	Ø tête 4.0 mm	Ø tête 5.0 mm
22.717	■	-	-040B	-050B
22.717	□	-033C	-040C	-050C
-	-	-	-	-
L mm	↔	1.00	1.00	1.00

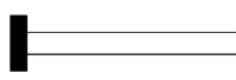

T. 819

MSA		Ø tête 4.0 mm
22.738	□	-040C
-	-	-
L mm	↔	1.30

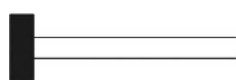

T. 820

MSA		Ø tête 4.0 mm	Ø tête 5.0 mm
22.718	□	-040C	-050C
-	-	-	-
L mm	↔	2.00	2.00



T. 822

MSA		Ø tête 0.8 mm
22.733	■	-008B
22.733	□	-008C
22.733	■	-008D
22.733	■	-008E
-	-	-
L mm	↔	2.00

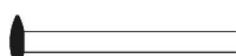

T. 825

MSA		Ø tête 1.8 mm	Ø tête 2.5 mm	Ø tête 4.0 mm
22.720	■	-	-	-040B
22.720	□	-018C	-025C	-040C
-	-	-	-	-
L mm	↔	0.80	0.90	1.10



T. 826

MSA		Ø tête 1.8 mm
22.721	□	-018C
-	-	-
L mm	↔	3.00



# FRAISES DIAMANTÉES

Exemple de commande : MSA22.706-xxxx  
(Extensions 3 chiffres + 1 lettre = Ø tête mm + grain)

MSA22.706-012G = Ø 1.20 mm + grain ultra grossier  
MSA22.706-016E = Ø 1.60 mm + grain extra fin

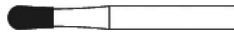
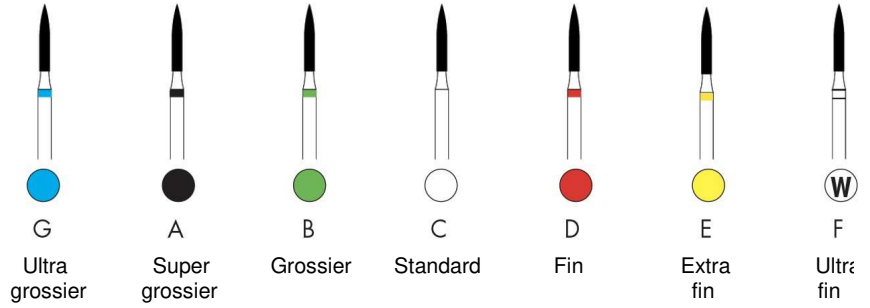
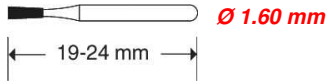

T. 830

MSA		Ø tête 0.9 mm	Ø tête 1.0 mm	Ø tête 1.2 mm	Ø tête 1.4 mm	Ø tête 1.6 mm
22.706		-	-	-012G	-014G	-
22.706		-	-	-012A	-014A	-016A
22.706		-	-010B	-012B	-014B	-016B
22.706		-009C	-010C	-012C	-014C	-016C
22.706		-	-010D	-012D	-014D	-016D
22.706		-	-010E	-012E	-014E	-016E
-		-	-	-	-	-
L mm		3.00	3.00	3.00	3.00	3.00

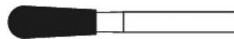

T. 830L

MSA		Ø tête 1.0 mm	Ø tête 1.2 mm	Ø tête 1.4 mm	Ø tête 1.6 mm	Ø tête 1.8 mm	Ø tête 2.5 mm
22.707		-	-012G	-014G	-	-	-025G
22.707		-	-012A	-014A	-016A	-018A	-
22.707		-	-012B	-014B	-016B	-018B	-025B
22.707		-010C	-012C	-014C	-016C	-018C	-025C
22.707		-	-012D	-014D	-016D	-018D	-025D
22.707		-	-012E	-014E	-016E	-	-
-		-	-	-	-	-	-
L mm		4.00	4.00	5.00	5.00	5.00	7.00

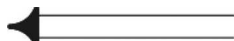

T. 832







MSA		Ø tête 2.7 mm
22.736		-027C
22.736		-027D
22.736		-027E
-		-
L mm		2.70









T. 835

MSA		Ø tête 0.8 mm	Ø tête 0.9 mm	Ø tête 1.0 mm	Ø tête 1.2 mm	Ø tête 1.4 mm	Ø tête 1.6 mm	Ø tête 2.7 mm
22.741		-	-009A	-010A	-012A	-014A	-016A	-
22.741		-008B	-009B	-010B	-012B	-014B	-016B	-
22.741		-008C	-009C	-010C	-012C	-014C	-016C	-027C
22.741		-	-	-010D	-012D	-014D	-016D	-
22.741		-	-	-010E	-	-	-	-
-		-	-	-	-	-	-	-
L mm		3.00	3.00	4.00	4.00	4.00	4.00	5.00







T. 836

MSA		Ø tête 1.0 mm	Ø tête 1.2 mm	Ø tête 1.4 mm	Ø tête 1.8 mm	Ø tête 2.7 mm
22.742		-	-012G	-014G	-	-027G
22.742		-010A	-012A	-014A	-	-
22.742		-010B	-012B	-014B	-018B	-
22.742		-010C	-012C	-014C	-018C	-027C
22.742		-010D	-012D	-014D	-018D	-027D
-		-	-	-	-	-
L mm		6.00	6.00	6.00	6.00	7.00





T. 837

MSA		Ø tête 1.0 mm	Ø tête 1.2 mm	Ø tête 1.4 mm	Ø tête 1.6 mm	Ø tête 1.8 mm
22.743		-	-	-014G	-016G	-
22.743		-010A	-012A	-014A	-016A	-
22.743		-010B	-012B	-014B	-016B	-018B
22.743		-010C	-012C	-014C	-016C	-018C
22.743		-010D	-012D	-014D	-016D	-018D
-		-	-	-	-	-
L mm		7.00	8.00	8.00	8.00	8.00





T. 838

MSA		Ø tête 0.8 mm	Ø tête 0.9 mm	Ø tête 1.0 mm	Ø tête 1.2 mm
22.745		-	-	-	-012G
22.745		-	-	-010A	-012A
22.745		-	-	-010B	-012B
22.745		-008C	-009C	-010C	-012C
22.745		-	-	-010D	-012D
-		-	-	-	-
L mm		3.00	3.00	4.00	4.00

T. 842

MSA		Ø tête 1.2 mm	Ø tête 1.4 mm	Ø tête 1.6 mm	Ø tête 1.8 mm
22.744		-	-014G	-016G	-018G
22.744		-012B	-014B	-016B	-018B
22.744		-012C	-014C	-016C	-018C
22.744		-012D	-014D	-016D	-
-		-	-	-	-
L mm		10.00	10.00	10.00	10.00

T. 845

MSA		Ø tête 0.9 mm	Ø tête 1.0 mm	Ø tête 1.2 mm	Ø tête 1.4 mm	Ø tête 1.6 mm	Ø tête 1.8 mm	Ø tête 2.1 mm
22.756		-	-	-012A	-014A	-	-	-
22.756		-	-010B	-012B	-014B	-016B	-	-
22.756		-009C	-010C	-012C	-014C	-016C	-018C	-021C
22.756		-	-	-012D	-	-	-	-
-		-	-	-	-	-	-	-
L mm		3.00	4.00	4.00	4.00	4.00	4.00	4.00

# FRAISES DIAMANTÉES

Exemple de commande : MSA22.757-xxxx  
(Extensions 3 chiffres + 1 lettre = Ø tête mm + grain)

MSA22.757-012A = Ø 1.20 mm + grain super grossier  
MSA22.757-018F = Ø 1.80 mm + grain ultra fin

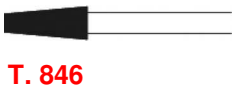
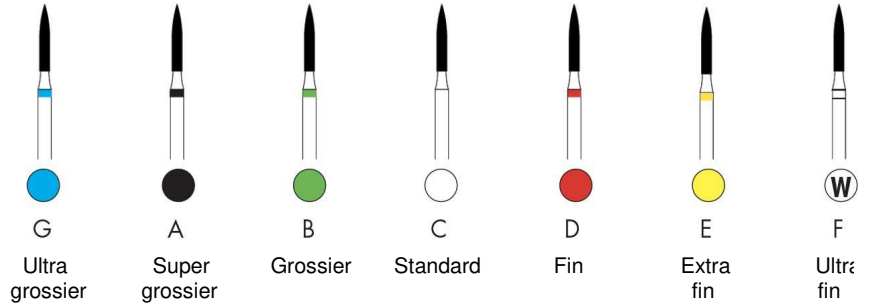
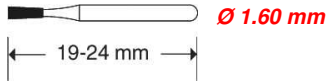

MSA		Ø tête 1.2 mm	Ø tête 1.6 mm	Ø tête 1.8 mm	Ø tête 2.5 mm
22.757		-012A	-016A	-018A	-
22.757		-012B	-016B	-018B	-025B
22.757		-012C	-016C	-018C	-025C
22.757		-012D	-016D	-018D	-025D
22.757		-	-	-018E	-
22.757		-	-	-018F	-
-		-	-	-	-
L mm		6.00	6.00	6.00	7.00



MSA		Ø tête 1.2 mm	Ø tête 1.4 mm	Ø tête 1.6 mm	Ø tête 1.8 mm	Ø tête 2.1 mm
22.758		-012G	-	-016G	-018G	-
22.758		-012A	-014A	-016A	-018A	-021A
22.758		-012B	-014B	-016B	-018B	-021B
22.758		-012C	-014C	-016C	-018C	-021C
22.758		-012D	-014D	-016D	-018D	-021D
22.758		-	-	-016E	-	-
-		-	-	-	-	-
L mm		8.00	8.00	8.00	8.00	8.00

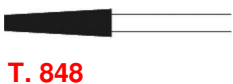

MSA		Ø tête 1.2 mm	Ø tête 1.4 mm	Ø tête 1.6 mm	Ø tête 1.8 mm	Ø tête 2.3 mm	Ø tête 2.5 mm
22.759		-012G	-	-016G	-018G	-	-
22.759		-012A	-014A	-016A	-018A	-	-
22.759		-012B	-014B	-016B	-018B	-023B	025B
22.759		-012C	-014C	-016C	-018C	-023C	025C
22.759		-012D	-014D	-016D	-018D	-023D	025D
22.759		-	-	-016E	-	-023E	-
-		-	-	-	-	-	-
L mm		10.00	10.00	10.00	10.00	10.00	10.00



T. 849

MSA		Ø tête 0.9 mm	Ø tête 1.0 mm	Ø tête 1.2 mm
22.760		-	-	-012G
22.760		-	-	-012A
22.760		-	-010B	-012B
22.760		-009C	-010C	-012C
22.760		-009D	-	-012D
22.760		-	-010E	-
-		-	-	-
L mm		4.00	4.00	4.00



T. 850

MSA		Ø tête 1.2 mm	Ø tête 1.4 mm	Ø tête 1.6 mm	Ø tête 1.8 mm	Ø tête 2.3 mm
22.765		-012G	-014G	-016G	-018G	-023G
22.765		-012A	-014A	-016A	-018A	-023A
22.765		-012B	-014B	-016B	-018B	-023B
22.765		-012C	-014C	-016C	-018C	-023C
22.765		-012D	-014D	-016D	-018D	-023D
22.765		-012E	-	-016E	-	-023E
-		-	-	-	-	-
L mm		10.00	10.00	10.00	10.00	10.00



T. 852

MSA		Ø tête 1.0 mm	Ø tête 1.2 mm
22.766		-	-012A
22.766		-	-012B
22.766		-010C	-012C
22.766		-010D	-012D
22.766		-010E	-012E
22.766		-010F	-012F
-		-	-
L mm		4.00	6.00

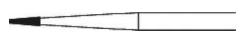

T. 853

MSA		Ø tête 0.8 mm
22.740		-008C
22.740		-008D
22.740		-008E
22.740		-008F
-		-
L mm		3.00



T. 855

MSA		Ø tête 1.2 mm	Ø tête 1.4 mm
22.762		-	-014G
22.762		-012A	-014A
22.762		-012B	-014B
22.762		-012C	-014C
22.762		-012D	-014D
-		-	-
L mm		7.00	7.00

# FRAISES DIAMANTÉES

Exemple de commande : MSA22.761-xxxx  
(Extensions 3 chiffres + 1 lettre = Ø tête mm + grain)

MSA22.761-012B = Ø 1.20 mm + grain grossier  
MSA22.761-012D = Ø 1.20 mm + grain fin

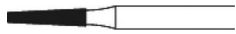
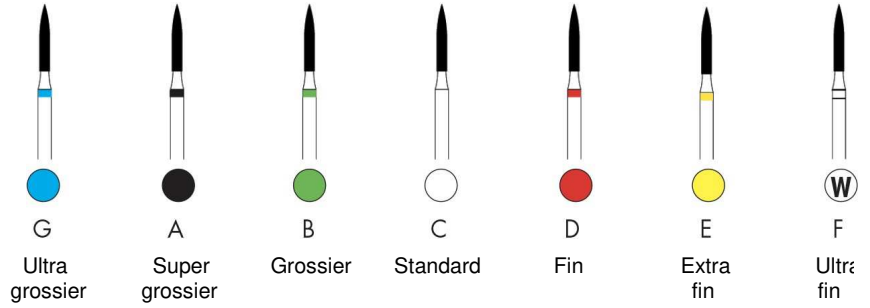
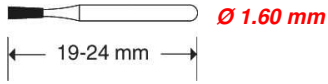

T. A855

MSA		Ø tête 1.2 mm
22.761		-012B
22.761		-012C
22.761		-012D
-		-
L mm		6.00



T. 856

MSA		Ø tête 1.2 mm	Ø tête 1.4 mm	Ø tête 1.6 mm	Ø tête 1.8 mm	Ø tête 2.3 mm
22.700		-012G	-014G	-016G	-018G	-023G
22.700		-012A	-014A	-016A	-018A	-023A
22.700		-012B	-014B	-016B	-018B	-023B
22.700		-012C	-014C	-016C	-018C	-023C
22.700		-012D	-014D	-016D	-018D	-023D
22.700		-	-014E	-016E	-	-023E
-		-	-	-	-	-
L mm		8.00	8.00	8.00	8.00	7.00



T. A856

MSA		Ø tête 2.1 mm	Ø tête 2.3 mm
22.764		-021G	-023G
22.764		-021A	-023A
22.764		-021B	-023B
22.764		-021C	-023C
22.764		-021D	-023D
22.764		-021E	-023E
-		-	-
L mm		8.00	8.00



T. 856L

MSA		Ø tête 2.3 mm
22.763		-023G
22.763		-023A
22.763		-023B
22.763		-023C
22.763		-023D
-		-
L mm		8.00





T. 858

MSA		Ø tête 1.2 mm	Ø tête 1.4 mm	Ø tête 1.6 mm	Ø tête 1.8 mm
22.767	■	-	-014A	-	-
22.767	■	-012B	-014B	-016B	-018B
22.767	□	-012C	-014C	-016C	-018C
22.767	■	-012D	-014D	-016D	-
22.767	■	-012E	-014E	-016E	-
22.767	Ⓜ	-	-014F	-	-
-	-	-	-	-	-
L mm	↔	8.00	8.00	8.00	8.00



T. 859

MSA		Ø tête 1.0 mm	Ø tête 1.2 mm	Ø tête 1.4 mm	Ø tête 1.6 mm	Ø tête 1.8 mm
22.768	■	-010A	-012A	-014A	-016A	-018A
22.768	■	-010B	-012B	-014B	-016B	-018B
22.768	□	-010C	-012C	-014C	-016C	-018C
22.768	■	-010D	-012D	-014D	-016D	-018D
22.768	■	-010E	-012E	-014E	-016E	-018E
22.768	Ⓜ	-	-012F	-	-016F	-018F
-	-	-	-	-	-	-
L mm	↔	10.00	10.00	10.00	10.00	10.00



T. 859L

MSA		Ø tête 1.2 mm
22.769	□	-012C
-	-	-
L mm	↔	11.00



T. 860

MSA		Ø tête 1.0 mm	Ø tête 1.2 mm	Ø tête 1.4 mm	Ø tête 2.5 mm
22.728	■	-010A	-012A	-014A	-025A
22.728	■	-010B	-012B	-014B	-025B
22.728	□	-010C	-012C	-014C	-025C
22.728	■	-010D	-012D	-014D	-025D
22.728	■	-010E	-012E	-014E	-025E
22.728	Ⓜ	-010F	-	-	-025F
-	-	-	-	-	-
L mm	↔	4.00	5.00	5.00	6.00



T. 862

MSA		Ø tête 0.9 mm	Ø tête 1.0 mm	Ø tête 1.2 mm	Ø tête 1.4 mm	Ø tête 1.6 mm
22.729	■	-	-	-012G	-014G	-
22.729	■	-	-010A	-012A	-014A	-016A
22.729	■	-	-010B	-012B	-014B	-016B
22.729	□	-009C	-010C	-012C	-014C	-016C
22.729	■	-009D	-010D	-012D	-014D	-016D
22.729	■	-	-010E	-012E	-014E	-
22.729	Ⓜ	-	-010F	-012F	-014F	-
-	-	-	-	-	-	-
L mm	↔	8.00	8.00	8.00	8.00	8.00

# FRAISES DIAMANTÉES

Exemple de commande : MSA22.730-xxxx  
(Extensions 3 chiffres + 1 lettre = Ø tête mm + grain)

MSA22.730-014G = Ø 1.40 mm + grain ultra grossier  
MSA22.730-018F = Ø 1.80 mm + grain ultra fin

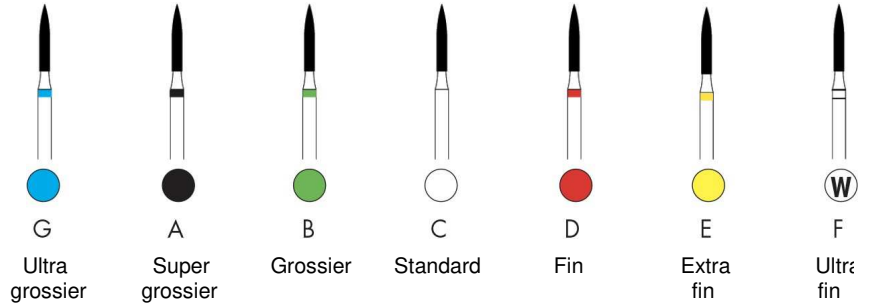
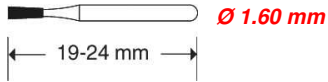

MSA	Ø tête 1.0 mm	Ø tête 1.2 mm	Ø tête 1.4 mm	Ø tête 1.6 mm	Ø tête 1.8 mm
22.730	-	-	-014G	-016G	-
22.730	-	-012A	-014A	-016A	-
22.730	-	-012B	-014B	-016B	-018B
22.730	-010C	-012C	-014C	-016C	-018C
22.730	-	-012D	-014D	-016D	-018D
22.730	-	-012E	-014E	-016E	-018E
22.730	-	-012F	-	-016F	-018F
-	-	-	-	-	-
L mm	↔ 10.00	10.00	10.00	10.00	10.00

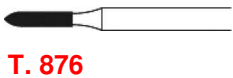

MSA	Ø tête 1.0 mm
22.752	-010B
22.752	-010C
22.752	-010D
22.752	-010E
-	-
L mm	↔ 5.00

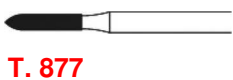

MSA	Ø tête 0.9 mm	Ø tête 1.0 mm	Ø tête 1.2 mm
22.753	-	-010A	-012A
22.753	-	-010B	-012B
22.753	-009C	-010C	-012C
22.753	-	-010D	-012D
22.753	-	-010E	-
-	-	-	-
L mm	↔ 6.00	6.00	6.00



MSA	Ø tête 0.9 mm	Ø tête 1.0 mm	Ø tête 1.2 mm	Ø tête 1.4 mm	Ø tête 1.6 mm
22.754	-	-010G	-012G	-014G	-
22.754	-	-010A	-012A	-014A	-016A
22.754	-	-010B	-012B	-014B	-016B
22.754	-009C	-010C	-012C	-014C	-016C
22.754	-	-010D	-012D	-014D	-016D
22.754	-009E	-010E	-012E	-014E	-
-	-	-	-	-	-
L mm	↔ 8.00	8.00	8.00	8.00	8.00

T. 879



MSA		Ø tête 1.0 mm	Ø tête 1.2 mm	Ø tête 1.4 mm	Ø tête 1.6 mm
22.755		-	-012G	-	-
22.755		-010A	-012A	-014A	-016A
22.755		-010B	-012B	-014B	-016B
22.755		-010C	-012C	-014C	-016C
22.755		-010D	-012D	-014D	-016D
22.755		-010E	-012E	-014E	--
-		-	-	-	-
L mm		10.00	10.00	10.00	10.00

T. 880



MSA		Ø tête 1.2 mm	Ø tête 1.4 mm	Ø tête 1.6 mm	Ø tête 1.8 mm
22.746		-012G	-	-	-
22.746		-012A	-014A	-016A	-018A
22.746		-012B	-014B	-016B	-018B
22.746		-012C	-014C	-016C	-018C
22.746		-012D	-014D	-016D	-
22.746		-	-014E	-	-
-		-	-	-	-
L mm		6.00	6.00	6.00	6.00

T. 881



MSA		Ø tête 1.0 mm	Ø tête 1.2 mm	Ø tête 1.4 mm	Ø tête 1.6 mm	Ø tête 1.8 mm
22.747		-	-	-014G	-	-018G
22.747		-010A	-012A	-014A	-016A	-018A
22.747		-010B	-012B	-014B	-016B	-018B
22.747		-010C	-012C	-014C	-016C	-018C
22.747		-010D	-012D	-014D	-016D	-018D
22.747		-	-012E	-014E	-016E	-018E
22.747		-	-012F	-	-	-
-		-	-	-	-	-
L mm		8.00	8.00	8.00	8.00	8.00

T. 882



MSA		Ø tête 1.2 mm	Ø tête 1.4 mm
22.748		-012A	-014A
22.748		-012B	-014B
22.748		-012C	-014C
22.748		-012D	-014D
22.748		-012E	-014E
-		-	-
L mm		10.00	10.00

# FRAISES DIAMANTÉES

Exemple de commande : MSA22.726-xxxx  
(Extensions 3 chiffres + 1 lettre = Ø tête mm + grain)

MSA22.726-010B = Ø 1.00 mm + grain grossier  
MSA22.726-010D = Ø 1.00 mm + grain fin

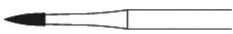
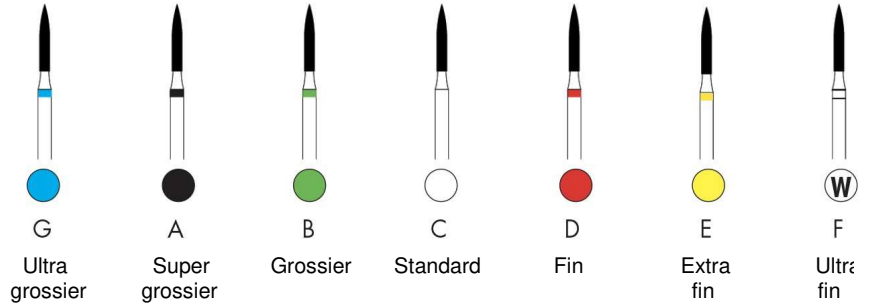
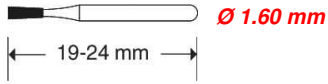

T. 883

MSA	Ø tête 1.0 mm
22.726	-010B
22.726	-010C
22.726	-010D
-	-
L mm	3.00



T. 884

MSA	Ø tête 1.2 mm
22.749	-012A
22.749	-012B
22.749	-012C
22.749	-012D
22.749	-012E
-	-
L mm	6.00



T. 885

MSA	Ø tête 1.0 mm	Ø tête 1.2 mm	Ø tête 1.4 mm
22.750	-	-012A	-014A
22.750	-	-012B	-014B
22.750	-010C	-012C	-014C
22.750	-	-012D	-014D
22.750	-	-012E	-014E
-	-	-	-
L mm	8.00	8.00	8.00



T. 886

MSA	Ø tête 1.2 mm	Ø tête 1.4 mm	Ø tête 1.6 mm
22.751	-012A	-014A	-
22.751	-012B	-014B	-016B
22.751	-012C	-014C	-016C
22.751	-012D	-014D	-016D
22.751	-012E	-014E	-
-	-	-	-
L mm	10.00	10.00	10.00



T. 888

MSA		Ø tête 1.2 mm
22.731	■	-012A
22.731	■	-012B
22.731	□	-012C
22.731	■	-012D
22.731	■	-012E
-		-
L mm	↔	8.00



T. 889

MSA		Ø tête 0.9 mm	Ø tête 1.0 mm
22.727	■	-009B	-010B
22.727	□	-009C	-010C
22.727	■	-009D	-010D
22.727	■	-009E	-010E
22.727	Ⓜ	-009F	-010F
-		-	-
L mm	↔	3.50	4.50



T. 890

MSA		Ø tête 1.6 mm
22.724	■	-016B
22.724	□	-016C
22.724	■	-016D
22.724	■	-016E
22.724	Ⓜ	-016F
-		-
L mm	↔	4.00

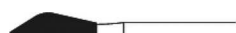

T. 899

MSA		Ø tête 2.1 mm	Ø tête 2.7 mm	Ø tête 3.1 mm
22.725	■	-021A	-027A	-031A
22.725	■	-021B	-027B	-031B
22.725	□	-021C	-027C	-031C
22.725	■	-021D	-027D	-031D
-		-	-	-
L mm	↔	6.50	7.00	7.00

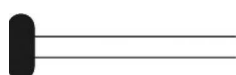

T. 909

MSA		Ø tête 3.3 mm	Ø tête 4.0 mm	Ø tête 5.0 mm
22.719	■	-	-040A	-
22.719	■	-033B	-040B	-
22.719	□	-033C	-040C	-050C
-		-	-	-
L mm	↔	1.00	1.70	2.20

# FRAISES DIAMANTÉES

Exemple de commande : MSA22.803-xxxx  
(Extensions 3 chiffres + 1 lettre = Ø tête mm + grain)

MSA22.803-018C = Ø 1.80 mm + grain standard  
MSA22.803-040B = Ø 4.00 mm + grain grossier

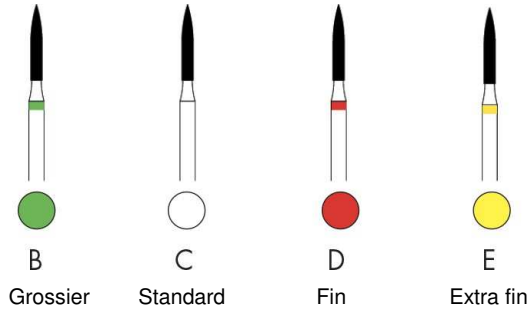
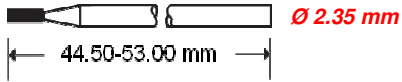

MSA	Ø tête 1.8 mm	Ø tête 2.5 mm	Ø tête 4.0 mm
T. 825			
22.803	-	-	-040B
22.803	-018C	-025C	-040C
-	-	-	-
L mm	↔ 0.80	0.90	1.10

MSA	Ø tête 1.2 mm	Ø tête 1.6 mm
T. 858		
22.800	-012C	-016C
22.800	-012D	-016D
-	-	-
L mm	↔ 8.00	8.00

MSA	Ø tête 1.4 mm
T. 859	
22.801	-014C
-	-
L mm	↔ 10.00

MSA	Ø tête 3.3 mm	Ø tête 4.0 mm	Ø tête 5.0 mm
T. 909			
22.802	-	-040B	-
22.802	-033C	-040C	-050C
-	-	-	-
L mm	↔ 1.00	1.70	2.20

MSA	Ø tête 1.4 mm
T. 166F	
22.805	-F014

MSA	Ø tête 1.2 mm
T. 248F	
22.806	-F012

MSA	Ø tête 1.6 mm
T. 272F	
22.807	-F016

Micro-forets SPIREC en HSS-E, acier rapide.



Préciser le Ø lors de votre commande.

Exemples :

MSA22.630-0.05 pour Ø 0.05 mm

MSA22.630-1.50 pour Ø 1.50 mm

MSA22.630-2.00 pour Ø 2.00 mm

MSA	Longueur	Ø tige	Ø	Progression	Kg
22.630-0.05	25 mm	1.00 mm	0.05 mm	0.01 mm	0.001
...	...	...	...	...	...
22.630-0.79	25 mm	1.00 mm	0.79 mm	0.01 mm	0.001
22.630-0.80	25 mm	1.50 mm	0.80 mm	0.01 mm	0.001
...	...	...	...	...	...
22.630-1.00	25 mm	1.50 mm	1.00 mm	0.01 mm	0.001
22.630-1.05	25 mm	1.50 mm	1.05 mm	0.05 mm	0.001
...	...	...	...	...	...
22.630-1.45	25 mm	1.50 mm	1.45 mm	0.05 mm	0.001
=====					
22.630-1.50	38 mm	2.00 mm	1.50 mm	-	0.001
22.630-1.55	38 mm	2.00 mm	1.55 mm	-	0.001
22.630-1.58	38 mm	2.00 mm	1.587 mm	-	0.001
22.630-1.60	38 mm	2.00 mm	1.60 mm	0.05 mm	0.001
...	...	...	...	...	...
22.630-1.95	38 mm	2.00 mm	1.95 mm	0.05 mm	0.001
22.630-1.98	38 mm	2.00 mm	1.984 mm	-	0.001
=====					
22.630-2.00	43 mm	2.50 mm	2.00 mm	0.05 mm	0.001
...	...	...	...	...	...
22.630-2.35	43 mm	2.50 mm	2.35 mm	0.05 mm	0.001
22.630-2.38	43 mm	2.50 mm	2.384 mm	-	0.001
22.630-2.40	43 mm	2.50 mm	2.40 mm	-	0.001
22.630-2.45	43 mm	2.50 mm	2.45 mm	-	0.001
=====					
22.630-2.50	46 mm	3.00 mm	2.50 mm	0.05 mm	0.001
...	...	...	...	...	...
22.630-2.75	46 mm	3.00 mm	2.75 mm	0.05 mm	0.001
22.630-2.77	46 mm	3.00 mm	2.778 mm	-	0.001
22.630-2.80	46 mm	3.00 mm	2.80 mm	0.05 mm	0.001
...	...	...	...	...	...
22.630-3.00	46 mm	3.00 mm	3.00 mm	0.05 mm	0.001
22.630-3.17	46 mm	3.00 mm	3.175 mm	-	0.001

Micro-forets TITEX en HSS, standard pour utilisation universelle.



Préciser le Ø lors de votre commande.

Exemples :

MSA22.660-020 pour Ø 0.20 mm

MSA22.660-205 pour Ø 2.05 mm

MSA22.660-1000 pour Ø 10.00 mm

MSA	Ø	Progression	Kg
22.660-020	0.20 mm	0.01 mm	0.001
...	...	...	...
22.660-200	2.00 mm	0.01 mm	0.001
=====			
22.660-205	2.05 mm	0.05 mm	0.001
...	...	...	...
22.660-995	9.95 mm	0.05 mm	0.001
=====			
22.660-1000	10.00 mm	0.10 mm	0.001
...	...	...	...
22.660-1690	16.90 mm	0.10 mm	0.001



**Micro-forets YAMAMOTO en HSS.**



Préciser le Ø lors de votre commande.

Exemples :

MSA22.670-010 pour Ø 0.10 mm

MSA22.670-076 pour Ø 0.76 mm

MSA22.670-135 pour Ø 1.35 mm

MSA	Ø tige	Ø	Progression	Kg
22.670-010	1.00 mm	0.10 mm	0.01 mm	0.001
...	...	...	...	...
22.670-075	1.00 mm	0.75 mm	0.01 mm	0.001
=====	=====	=====	=====	=====
22.670-076	1.50 mm	0.76 mm	0.01 mm	0.001
...	...	...	...	...
22.670-125	1.50 mm	1.25 mm	0.01 mm	0.001
=====	=====	=====	=====	=====
22.670-130	1.50 mm	1.30 mm	-	0.001
=====	=====	=====	=====	=====
22.670-135	2.00 mm	1.35 mm	0.05 mm	0.001
...	...	...	...	...
22.670-150	2.00 mm	1.50 mm	0.05 mm	0.001

**Micro-forets SPIREC en métal dur.**



Préciser le Ø lors de votre commande.

Exemples :

MSA22.640-0.05 pour Ø 0.05 mm

MSA22.640-0.80 pour Ø 0.80 mm

MSA22.640-1.51 pour Ø 1.51 mm

MSA	Ø tige	Ø	Progression	Longueur totale	Kg
22.640-0.05	1.00 mm	0.05 mm	0.01 mm	25 mm	0.001
...	...	...	...	...	...
22.640-0.79	1.00 mm	0.79 mm	0.01 mm	25 mm	0.001
=====	=====	=====	=====	=====	=====
22.640-0.80	1.50 mm	0.80 mm	0.01 mm	25 mm	0.001
...	...	...	...	...	...
22.640-1.50	1.50 mm	1.50 mm	0.01 mm	25 mm	0.001
=====	=====	=====	=====	=====	=====
22.640-1.51	2.00 mm	1.51 mm	0.01 mm	38 mm	0.001
...	...	...	...	...	...
22.640-2.00	2.00 mm	2.00 mm	0.01 mm	38 mm	0.001

**Forets en acier à outils trempé type 58PM, tige Ø 2.35 mm.**



MSA	Ø	Kg	MSA	Ø	Kg
22.610-005	0.50 mm	0.001	22.610-015	1.50 mm	0.001
22.610-006	0.60 mm	0.001	22.610-016	1.60 mm	0.001
22.610-007	0.70 mm	0.001	22.610-017	1.70 mm	0.001
22.610-008	0.80 mm	0.001	22.610-018	1.80 mm	0.001
22.610-009	0.90 mm	0.001	22.610-019	1.90 mm	0.001
22.610-010	1.00 mm	0.001	22.610-020	2.00 mm	0.001
22.610-011	1.10 mm	0.001	22.610-021	2.10 mm	0.001
22.610-012	1.20 mm	0.001	22.610-022	2.20 mm	0.001
22.610-013	1.30 mm	0.001	22.610-023	2.30 mm	0.001
22.610-014	1.40 mm	0.001			

Forets en carbure de tungstène type 58MD, tige Ø 2.35 mm.



MSA	Ø	Kg	MSA	Ø	Kg
22.412-005	0.50 mm	0.001	22.412-015	1.50 mm	0.001
22.412-006	0.60 mm	0.001	22.412-016	1.60 mm	0.001
22.412-007	0.70 mm	0.001	22.412-017	1.70 mm	0.001
22.412-008	0.80 mm	0.001	22.412-018	1.80 mm	0.001
22.412-009	0.90 mm	0.001	22.412-019	1.90 mm	0.001
22.412-010	1.00 mm	0.001	22.412-020	2.00 mm	0.001
22.412-011	1.10 mm	0.001	22.412-021	2.10 mm	0.001
22.412-012	1.20 mm	0.001	22.412-022	2.20 mm	0.001
22.412-013	1.30 mm	0.001	22.412-023	2.30 mm	0.001
22.412-014	1.40 mm	0.001			

Forets diamantés, tige Ø 2.35 mm.



MSA	Ø	Kg
22.650-080	0.80 mm	0.003
22.650-090	0.90 mm	0.003
22.650-100	1.00 mm	0.003
22.650-110	1.10 mm	0.003
22.650-130	1.30 mm	0.003
22.650-140	1.40 mm	0.003
22.650-150	1.50 mm	0.003

Forets en métal dur pour équilibrer les balanciers.

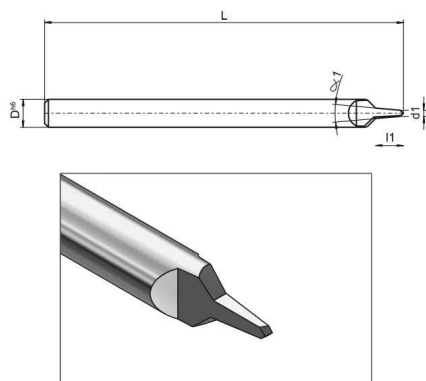

MSA	d1	Dh6	Angle	l1	L	Kg
22.572-017	0.17 mm	1.50 mm	16°	0.6 mm	21 mm	0.001
22.572-018	0.18 mm	1.50 mm	16°	0.6 mm	21 mm	0.001
22.572-019	0.19 mm	1.50 mm	16°	0.6 mm	21 mm	0.001
22.572-020	0.20 mm	1.50 mm	16°	0.6 mm	21 mm	0.001
22.572-021	0.21 mm	1.50 mm	16°	0.6 mm	21 mm	0.001
22.572-022	0.22 mm	1.50 mm	16°	0.6 mm	21 mm	0.001

