

A

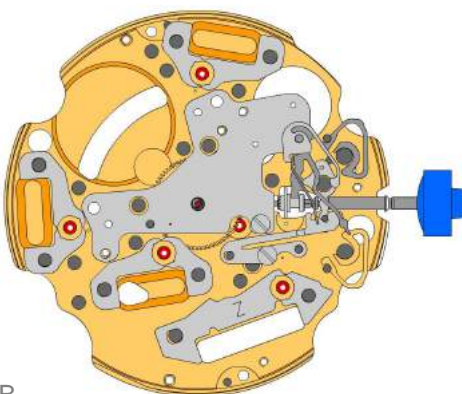
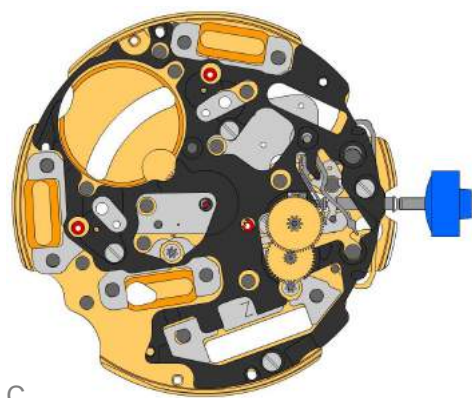

B

2000.576.G 1.		Platine
3305.287.CO 2.		Chaussée avec entraîneur (Aig.3)
2030.017.CO 3.		Pont de centre Pont de centre tenue par 1 vis 4000.250. Les pièces 2030.017.CO et 3402.009.CO doivent être échangées ensemble.
4000.250 4.		Vis
3001.045 5.		Pignon coulant
3000.177.CO 6.		Tige de mise à l'heure
3017.049 7.		Tirette
3905.053 8.		Sautoir de tirette (2 positions) Sautoir de tirette tenue par 1 vis 4000.250.
4000.250 9.		Vis
3015.080 10.		Bascule (2 positions)
3905.067 11.		Ressort de bascule
3406.030 12.		Sautoir de poussoir B Fixer le sautoir de poussoir gris entre les deux piliers plus loin.
3406.038 13.		Sautoir de poussoir A Fixer le sautoir de poussoir jaune entre les deux piliers plus proche.
3622.040 14.		Stator Marquage [Z] sur le stator.
3622.039 15.		Stator (cpt 6h, 9h, chrono)
3622.039 16.		Stator (cpt 6h, 9h, chrono)
3622.039 17.		Stator (cpt 6h, 9h, chrono)

C

3603.079
18.  **Potence plastique**
Potence plastique tenue par 4 vis 4000.250.

4000.250
19.  **Vis**

3715.094.RK
20.  **Rotor**

3715.094.RK
21.  **Rotor**

3147.046.CO
22.  **Roue intermédiaire**

3136.142.CO
23.  **Roue de seconde (longue)**

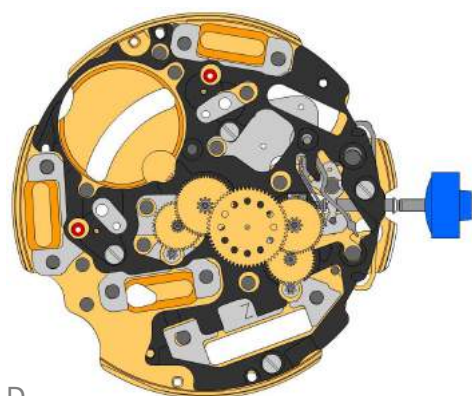
D

3147.047.CO
24.  **Roue intermédiaire (chrono)**

3136.150.CO
25.  **Roue de chronographe (Aig.3)**

3122.056.CO
26.  **Roue moyenne**

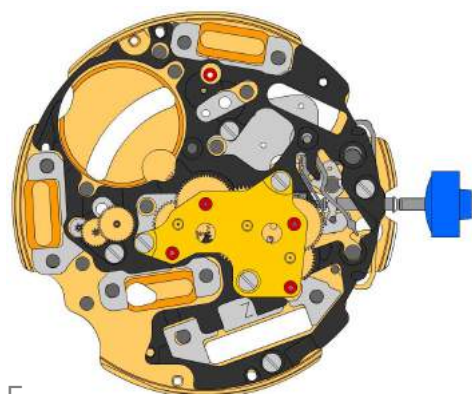

E

2020.148.G
27.  **Pont de rouage**
Pont de rouage tenue par 3 vis 4000.250.





4000.250
28.  **Vis**

3715.095.RK
29.  **Rotor**

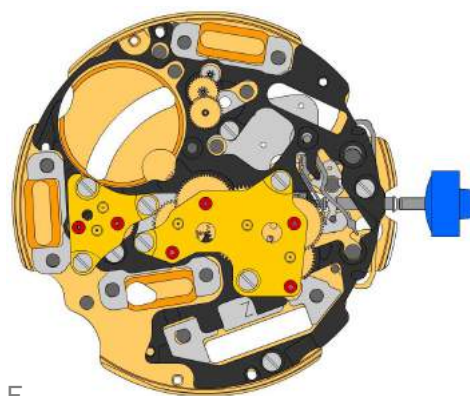
3147.048.CO
30.  **Roue intermédiaire (cpt)**

3402.006.CO
31.  **Roue compteuse de minutes**

F

2020.149.G 32.		Pont de rouage compteur Pont de rouage compteur tenue par 3 vis 4000.250.
4000.250 33.		Vis
3715.095.RK 34.		Rotor
3147.053.CO 35.		Roue intermédiaire (cpt 1/10sec)
3402.009.CO 36.		Roue compteuse de 1/10 sec Les pièces 2030.017.CO et 3402.009.CO doivent être échangées ensemble.

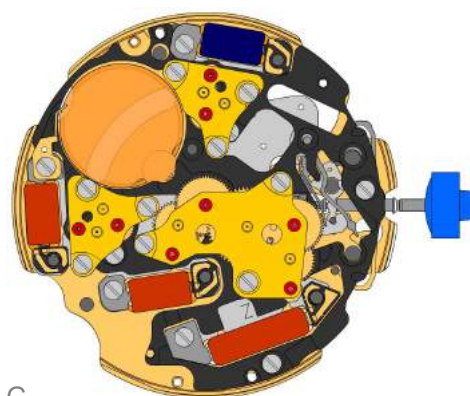

G

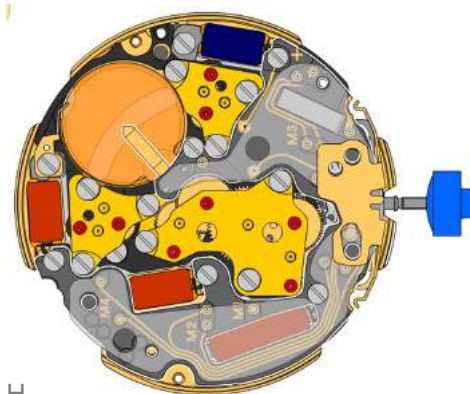
2020.149.G 37.		Pont de rouage compteur Pont de rouage compteur tenue par 3 vis 4000.250.
4000.250 38.		Vis
3621.053.RK 39.		Bobine Attention: Prendre la bobine uniquement par le noyau de bobine gris. Bobine tenue par 1 vis 4000.250.
3621.054.RK 40.		Bobine (cpt 9h, chrono) Attention: Prendre la bobine uniquement par le noyau de bobine gris. Bobine tenue par 1 vis 4000.250.
3621.054.RK 41.		Bobine (cpt 9h, chrono) Attention: Prendre la bobine uniquement par le noyau de bobine gris. Bobine tenue par 1 vis 4000.250.
3621.055.RK 42.		Bobine (cpt 6h) Attention: Prendre la bobine uniquement par le noyau de bobine gris. Bobine tenue par 1 vis 4000.250.
4000.250 43.		Vis
3601.118 44.		Bride contact Bride contact tenue par 1 vis 4000.250.
4000.250 45.		Vis
3603.034 46.		Isolateur pile

H

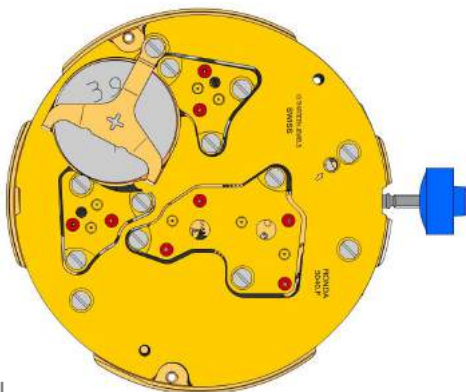
3612.144.5040 47.		Module électronique Module électronique tenue par 5 vis 4000.248. Les mesures électroniques peuvent être réaliser maintenant.
4000.248 48.		Vis
3603.069 49.		Isolateur de circuit
3601.107.G 50.		Ressort contact pousoirs



2130.137.G.M01.5040F 51.		Couvre-module électronique Couvre-module électronique tenue par 3 vis 4000.250.
3600.010.HGF 52.		Pile 395
3601.109.G 53.		Bride + Bride tenue par 1 vis 4000.250.
4000.250 54.		Vis

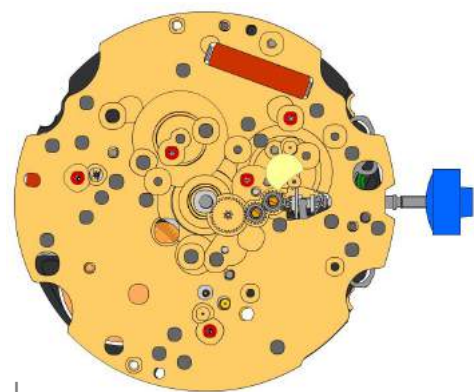

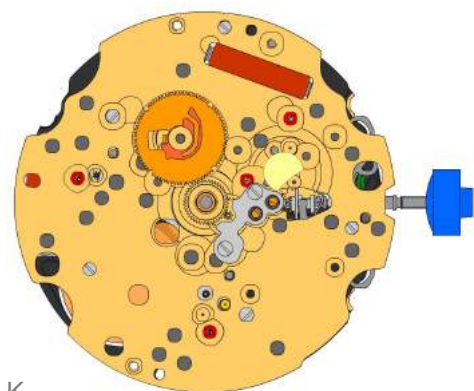

J

2000.576.G 55.		Platine
3004.164 56.		Renvoi
3004.164 57.		Renvoi
3007.078.CO 58.		Roue de minuterie



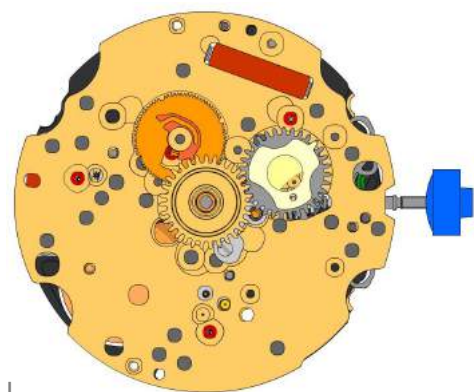

K

2130.177 59.		Pont du rouage de minuterie Pont du rouage de minuterie tenue par 2 vis 4000.319.
4000.319 60.		Vis
3301.247 61.		Roue des heures (Aig.3)
3004.171.CO 62.		Roue entraîneuse de quantième





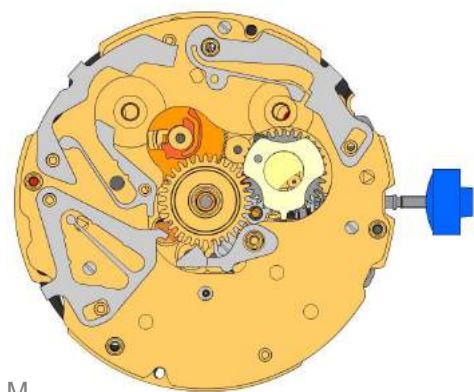
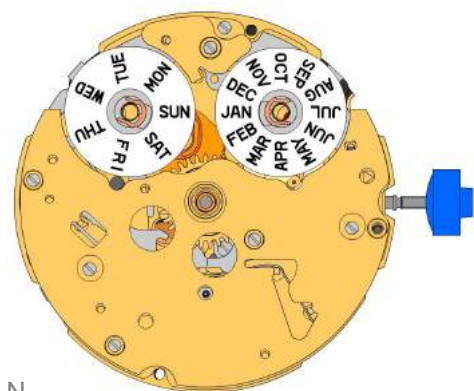

L

3004.173 63.		Roue entraîneuse des mois
3004.174 64.		Doigt des mois Les cames de la côte dessous du doigt des mois engrènent dans les deux fentes de la roue entraîneuse.
3301.248 65.		Roue indicateur de quantième



M

N

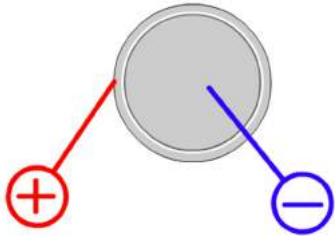
2130.155.CO 66.		Planche de calendrier Planche de calendrier tenue par 3 vis 4000.282.
4000.282 67.		Vis
3507.054 68.		Correcteur des mois
3507.055 69.		Correcteur des jours
3507.056 70.		Correcteur de quantième
3500.053 71.		Sautoir des jours
3500.065 72.		Sautoir de quantième
2130.157.G 73.		Plaque de maintien combiné Plaque de maintien combiné tenue par 4 vis 4000.286.
4000.286 74.		Vis
2130.166.G 75.		Plaque de maintien du correcteur Plaque maintien correcteur tenue par 1 vis 4000.286.
4000.286 76.		Vis
3905.059 77.		Ressort sautoir de quantième Insertion du ressort sautoir de quantième dans l'ouverture.
3508.153.AA.E.A 78.		Indicateurs des jours (standard)
3508.154.AE.E.A 79.		Indicateur des mois (standard)
3909.028 80.		Clavette
3909.028 81.		Clavette

8200 82.		Moebius 8200
9014 83.		Moebius 9014
124 84.		Jismaa 124
9020 85.		Moebius 9020

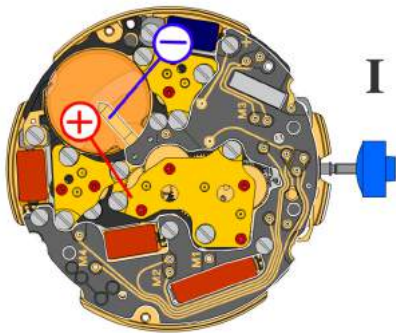

Pile	395
Tension	1.55 V



Tige de mise à l'heure en position I, calendrier hors engrenage, intervalle de mesure 60 s pour la marche et la consommation:

Consommation typique	1.32 μA
Consommation maximale	1.65 μA
Marche	-10s/M. .. +20s/M.
Limite inférieure de la tension de fonctionnement	1.20 V

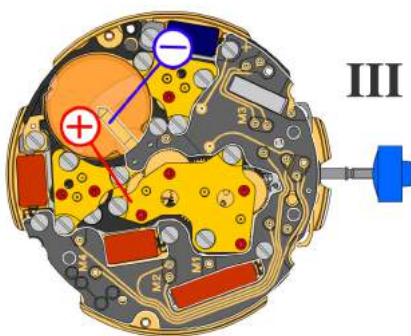

Tige de mise à l'heure en position III, intervalle de mesure 60 s:

Typical consumption	0.10 μA
Maximal consumption	0.30 μA

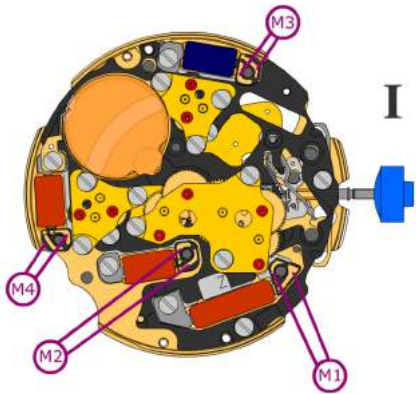

Résistance de la bobine M1 **1.90 kΩ .. 2.10 kΩ**

Résistance de la bobine M2 **1.68 kΩ .. 1.88 kΩ**

Résistance de la bobine M3 **1.68 kΩ .. 1.88 kΩ**

Résistance de la bobine M4 **1.68 kΩ .. 1.88 kΩ**

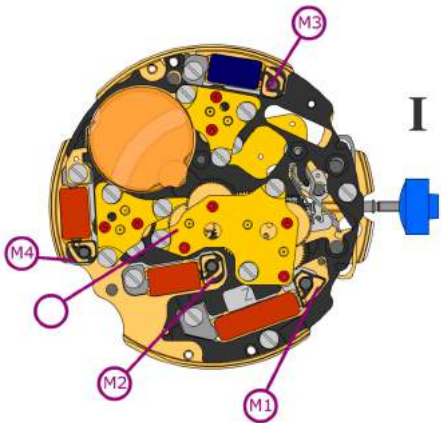

Isolation de la bobine
M1/M2/M3/M4 **∞ kΩ**

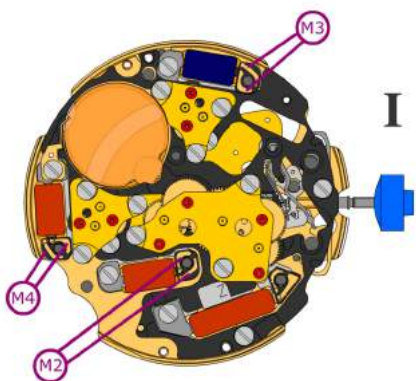

Générateur d'impulsion
(4.9 ms, 8 Hz):

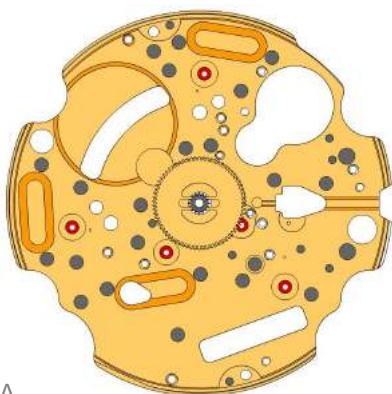

Limite inférieure de la tension de
fonctionnement M2/M3/M4 **1.20 V**

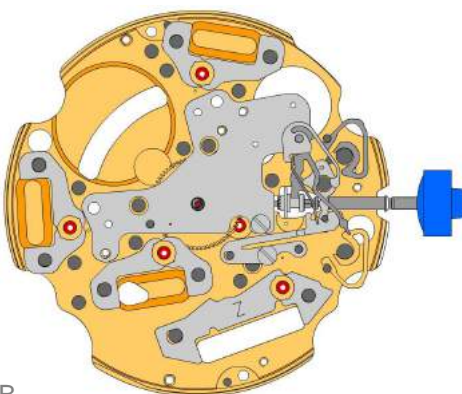

A



B

2000.576.G 1.		Main plate
3305.287.CO 2.		Cannon pinion with driver (Aig.3)
2030.017.CO 3.		Centre bridge Centre bridge held by 1 screw 4000.250. Parts 2030.017.CO and 3402.009.CO must be exchanged together.
4000.250 4.		Screw
3001.045 5.		Sliding pinion
3000.177.CO 6.		Setting stem
3017.049 7.		Setting lever
3905.053 8.		Setting lever jumper (2 positions) Setting lever jumper held by 1 screw 4000.250.
4000.250 9.		Screw
3015.080 10.		Yoke (2 positions)
3905.067 11.		Yoke spring
3406.030 12.		Pusher jumper B Put the grey jumper between the two posts on the further side.
3406.038 13.		Pusher jumper A Put the yellow jumper between the two posts on the closer side.
3622.040 14.		Stator Mark [Z] on stator.
3622.039 15.		Stator (counter 6h, 9h, chrono)
3622.039 16.		Stator (counter 6h, 9h, chrono)
3622.039 17.		Stator (counter 6h, 9h, chrono)

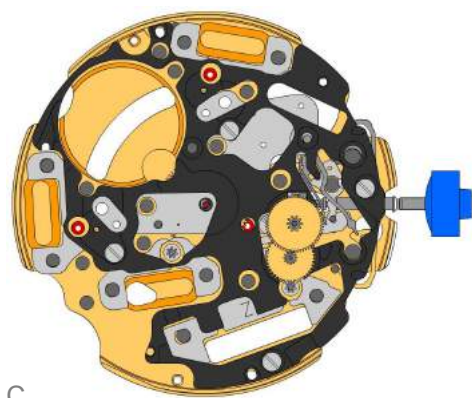
C

3603.079
18.  **Plastic bracket**
Plastic bracket held by 4 screws 4000.250.

4000.250
19.  **Screw**

3715.094.RK
20.  **Rotor**

3715.094.RK
21.  **Rotor**

3147.046.CO
22.  **Intermediate wheel**

3136.142.CO
23.  **Second wheel (long)**

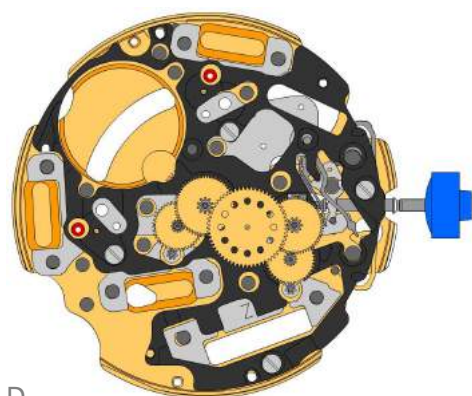

D

3147.047.CO
24.  **Intermediate wheel (chrono)**

3136.150.CO
25.  **Chronograph wheel (Aig.3)**

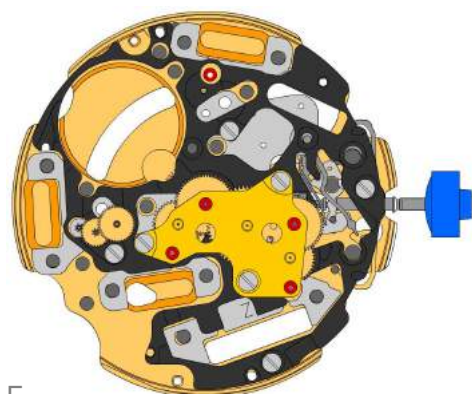
3122.056.CO
26.  **Third wheel**

E

2020.148.G
27.  **Train wheel bridge**
Train wheel bridge held by 3 screws 4000.250.

4000.250
28.  **Screw**



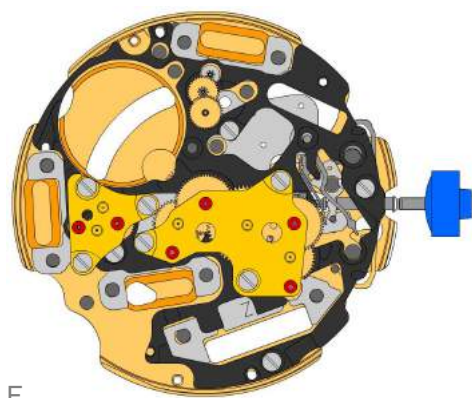

3715.095.RK
29.  **Rotor**

3147.048.CO
30.  **Intermediate wheel (counter)**

3402.006.CO
31.  **Minute counting wheel**







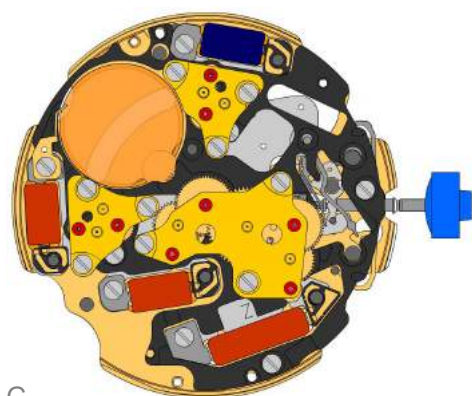





F

2020.149.G 32.		Counter train wheel bridge Counter train wheel bridge held by 3 screws 4000.250.
4000.250 33.		Screw
3715.095.RK 34.		Rotor
3147.053.CO 35.		Intermediate wheel (counter 1/10sec)
3402.009.CO 36.		Counting wheel 1/10 sec Parts 2030.017.CO and 3402.009.CO must be exchanged together.





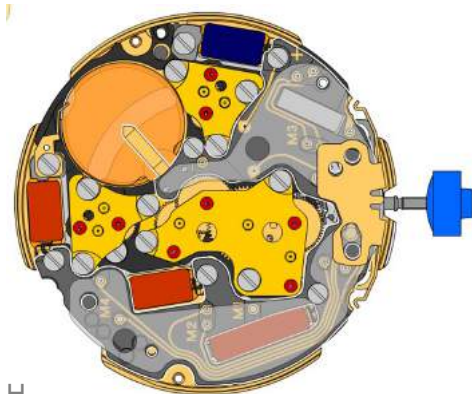

G

2020.149.G 37.		Counter train wheel bridge Counter train wheel bridge held by 3 screws 4000.250.
4000.250 38.		Screw
3621.053.RK 39.		Coil Attention: Please hold the coil only on the grey coil core. Coil held by 1 screw 4000.250.
3621.054.RK 40.		Coil (counter 9h, chrono) Attention: Please hold the coil only on the grey coil core. Coil held by 1 screw 4000.250.
3621.054.RK 41.		Coil (counter 9h, chrono) Attention: Please hold the coil only on the grey coil core. Coil held by 1 screw 4000.250.
3621.055.RK 42.		Coil (counter 6h) Attention: Please hold the coil only on the grey coil core. Coil held by 1 screw 4000.250.
4000.250 43.		Screw
3601.118 44.		Contact strip Contact strip held by 1 screw 4000.250.
4000.250 45.		Screw
3603.034 46.		Battery insulator



H

3612.144.5040 47.		Electronic module Electronic module held by 5 screws 4000.248. Electronic measurements may be realised now.
4000.248 48.		Screw
3603.069 49.		Circuit insulator
3601.107.G 50.		Pusher contact spring

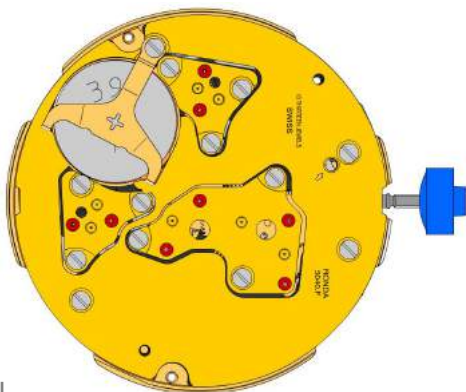

2130.137.G.M01.5040F
51.  **Electronic module cover**
Electronic module cover held by 3 screws 4000.250.



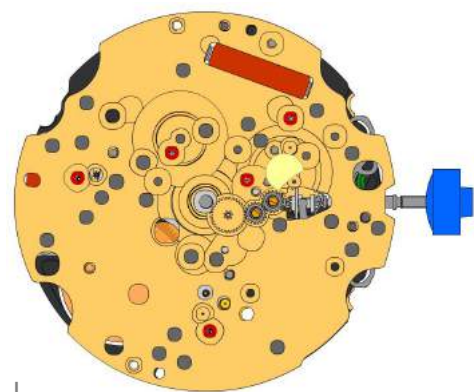

3600.010.HGF
52.  **Battery 395**

3601.109.G
53.  **Bridge +**
Bridge held by 1 screw 4000.250.

4000.250
54.  **Screw**





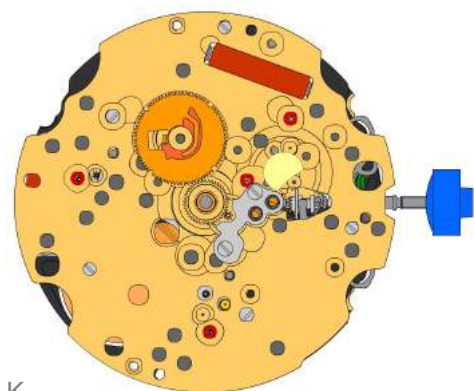

J

2000.576.G 55.		Main plate
3004.164 56.		Setting wheel
3004.164 57.		Setting wheel
3007.078.CO 58.		Minute wheel



K



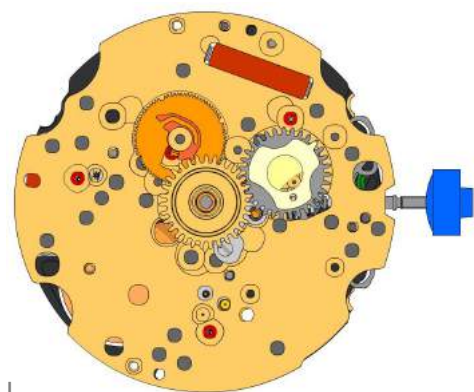





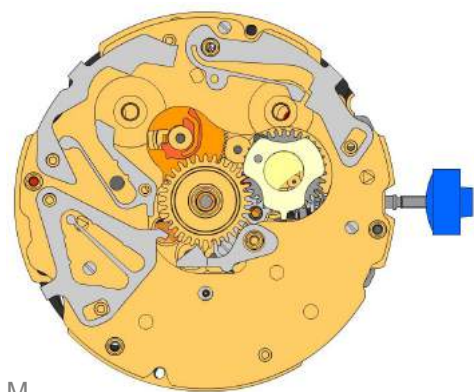
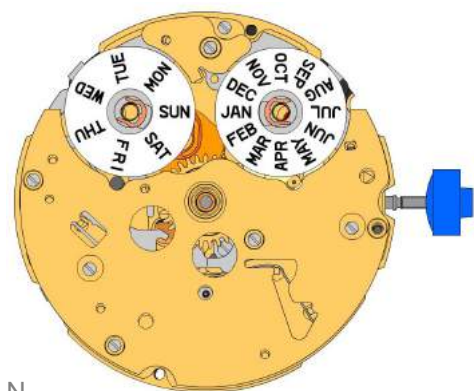







2130.177 59.		Minute train bridge Minute train bridge held by 4 screws 4000.319.
4000.319 60.		Screw
3301.247 61.		Hour wheel (Aig.3)
3004.171.CO 62.		Date indicator driving wheel







L

3004.173 63.		Month driving wheel
3004.174 64.		Month finger Ridges at the bottom side from the month meshed in both gaps of the month driving wheel.
3301.248 65.		Date indicator wheel



M

N

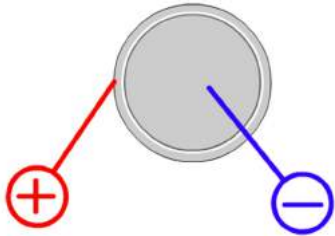
2130.155.CO 66.		Date platform Date platform held by 3 screws 4000.282.
4000.282 67.		Screw
3507.054 68.		Month corrector
3507.055 69.		Day corrector
3507.056 70.		Date corrector
3500.053 71.		Day jumper
3500.065 72.		Date jumper
2130.157.G 73.		Combined maintaining plate Combined maintaining plate held by 4 screws 4000.286.
4000.286 74.		Screw
2130.166.G 75.		Corrector maintaining plate Corrector maintaining plate held by 1 screw 4000.286.
4000.286 76.		Screw
3905.059 77.		Date jumper spring Insert the date jumper spring in the provided opening.
3508.153.AA.E.A 78.		Day indicator (standard)
3508.154.AE.E.A 79.		Month indicator(standard)
3909.028 80.		Pillar spring clip
3909.028 81.		Pillar spring clip

8200 82.		Moebius 8200
9014 83.		Moebius 9014
124 84.		Jismaa 124
9020 85.		Moebius 9020

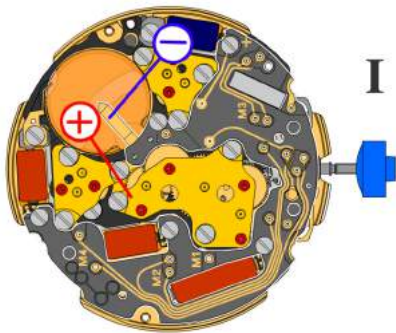

Battery	395
Voltage	1.55 V



*Setting stem in position I, calendar not in gear,
60 s measuring interval for rate and consumption:*

Typical consumption	1.32 μA
Maximal consumption	1.65 μA
Rate	-10s/M. .. +20s/M.
Lower working voltage limit	1.20 V

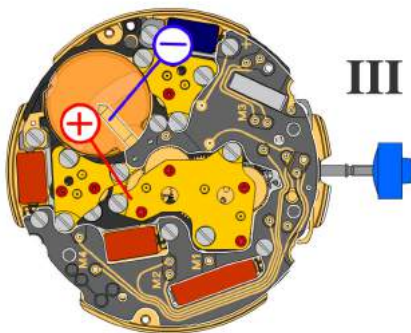

Setting stem in position III, 60 s measuring interval:

Typical consumption	0.10 μA
Maximal consumption	0.30 μA

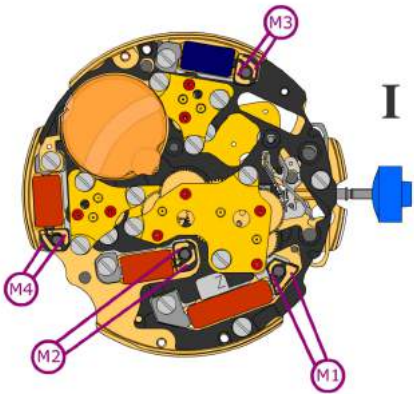

Coil resistance M1 **1.90 k Ω .. 2.10 k Ω**

Coil resistance M2 **1.68 k Ω .. 1.88 k Ω**

Coil resistance M3 **1.68 k Ω .. 1.88 k Ω**

Coil resistance M4 **1.68 k Ω .. 1.88 k Ω**

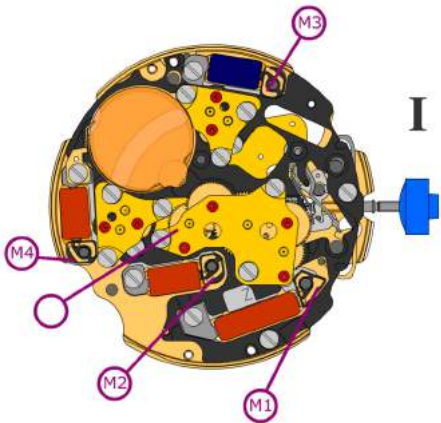

Coil isolation M1/M2/M3/M4 **∞ k Ω**

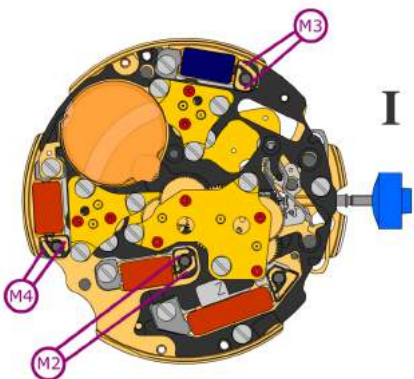

Signal generator (4.9 ms, 8 Hz):



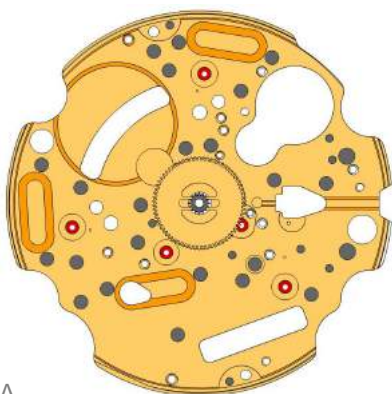

Lower working voltage limit
M2/M3/M4 **1.20 V**

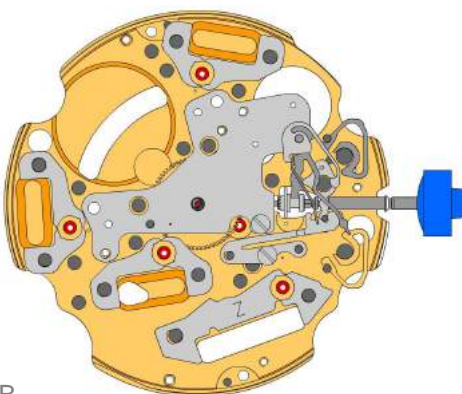

A



B

2000.576.G 1.		Werkplatte
3305.287.CO 2.		Minutenrohr mit Mitnehmer (Aig.3)
2030.017.CO 3.		Zentrumbrücke Zentrumbrücke gehalten durch 1 Schraube 4000.250. Die Teile 2030.017.CO und 3402.009.CO sind zusammen auszutauschen.
4000.250 4.		Schraube
3001.045 5.		Kupplungstrieb
3000.177.CO 6.		Stellwelle
3017.049 7.		Winkelhebel
3905.053 8.		Winkelhebelraste (2 Positionen) Winkelhebelraste gehalten durch 1 Schraube 4000.250.
4000.250 9.		Schraube
3015.080 10.		Wippe (2 Positionen)
3905.067 11.		Wippenfeder
3406.030 12.		Drückerraste B Graue Drückerraste zwischen den beiden Säulen auf der entfernteren Seite platzieren.
3406.038 13.		Drückerraste A Gelbe Drückerraste zwischen den beiden Säulen auf der näheren Seite platzieren.
3622.040 14.		Stator Markierung [Z] auf Stator.
3622.039 15.		Stator (Zähler 6h, 9h, Chrono)
3622.039 16.		Stator (Zähler 6h, 9h, Chrono)
3622.039 17.		Stator (Zähler 6h, 9h, Chrono)

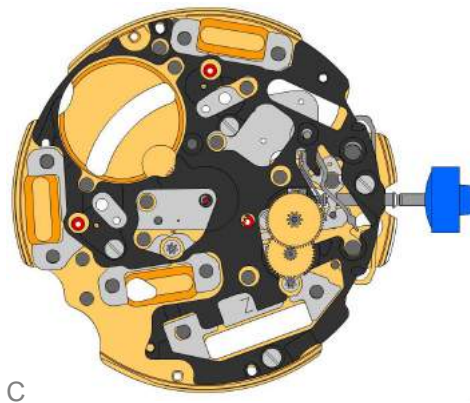

C

3603.079
18.  Kunststoffhalterung
Kunststoffhalterung gehalten durch 4 Schrauben 4000.250.

4000.250
19.  Schraube

3715.094.RK
20.  Rotor

3715.094.RK
21.  Rotor

3147.046.CO
22.  Zwischenrad

3136.142.CO
23.  Sekundenrad (lang)

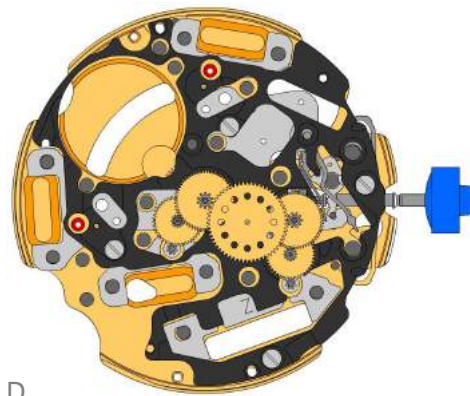

D

3147.047.CO
24.  Zwischenrad (Chrono)

3136.150.CO
25.  Chrono-Zentrumrad (Aig.3)

3122.056.CO
26.  Kleinbodenrad

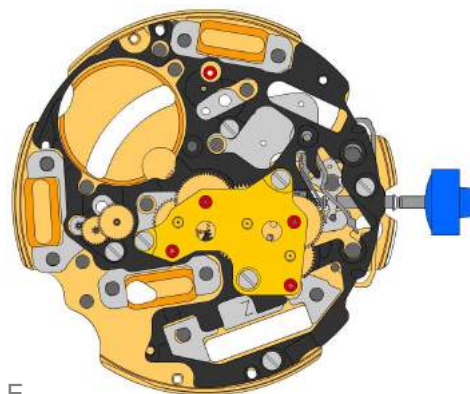

E

2020.148.G
27.  Räderwerkbrücke
Räderwerkbrücke gehalten durch 3 Schrauben 4000.250.

4000.250
28.  Schraube

3715.095.RK
29.  Rotor

3147.048.CO
30.  Zwischenrad (Zähler)

3402.006.CO
31.  Minutenzählrad

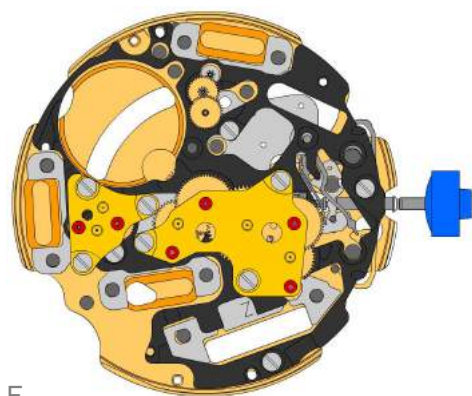





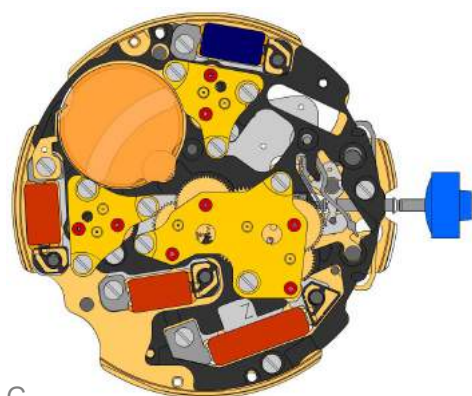





F

2020.149.G 32.		Zähler-Räderwerkbrücke Zähler-Räderwerkbrücke gehalten durch 3 Schrauben 4000.250.
4000.250 33.		Schraube
3715.095.RK 34.		Rotor
3147.053.CO 35.		Zwischenrad (Zähler 1/10sek)
3402.009.CO 36.		Zählrad 1/10 sek Die Teile 2030.017.CO und 3402.009.CO sind zusammen auszutauschen.



G



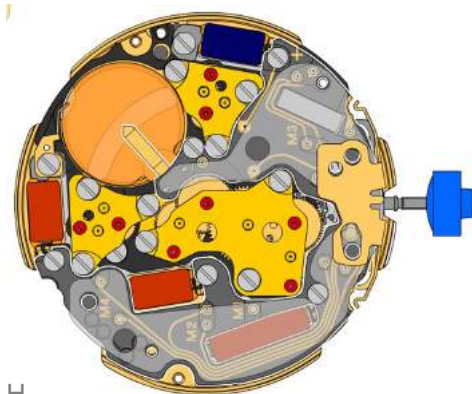

2020.149.G 37.		Zähler-Räderwerkbrücke Zähler-Räderwerkbrücke gehalten durch 3 Schrauben 4000.250.
4000.250 38.		Schraube
3621.053.RK 39.		Spule Achtung: Spule nur am grauen Spulenkern halten. Spule gehalten durch 1 Schrauben 4000.250.
3621.054.RK 40.		Spule (Zähler 9h, Chrono) Achtung: Spule nur am grauen Spulenkern halten. Spule gehalten durch 1 Schrauben 4000.250.
3621.054.RK 41.		Spule (Zähler 9h, Chrono) Achtung: Spule nur am grauen Spulenkern halten. Spule gehalten durch 1 Schrauben 4000.250.
3621.055.RK 42.		Spule (Zähler 6h) Achtung: Spule nur am grauen Spulenkern halten. Spule gehalten durch 1 Schrauben 4000.250.
4000.250 43.		Schraube
3601.118 44.		Kontaktbügel Kontaktbügel gehalten durch 1 Schrauben 4000.250.
4000.250 45.		Schraube
3603.034 46.		Isolation für Batterie

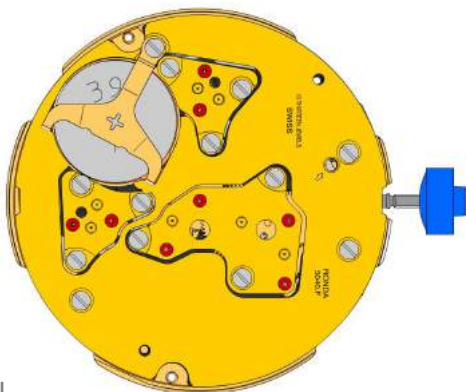

H

3612.144.5040 47.		Elektronikmodul Elektronikmodul gehalten durch 5 Schrauben 4000.248. Elektronische Messungen können nun vorgenommen werden.
4000.248 48.		Schraube
3603.069 49.		Isolation für Schaltung
3601.107.G 50.		Drückerkontaktfeder



2130.137.G.M01.5040F 51.		Deckplatte für Elektronikmodul Deckplatte für Elektronikmodul gehalten durch 3 Schrauben 4000.250.
3600.010.HGF 52.		Batterie 395
3601.109.G 53.		Bügel + Bügel gehalten durch 1 Schraube 4000.250.
4000.250 54.		Schraube

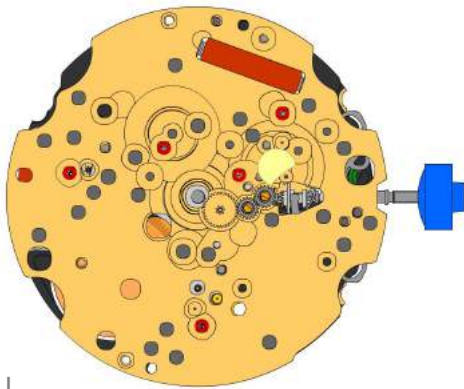

J

 2000.576.G
55.  Werkplatte

 3004.164
56.  Zeigerstellrad

 3004.164
57.  Zeigerstellrad

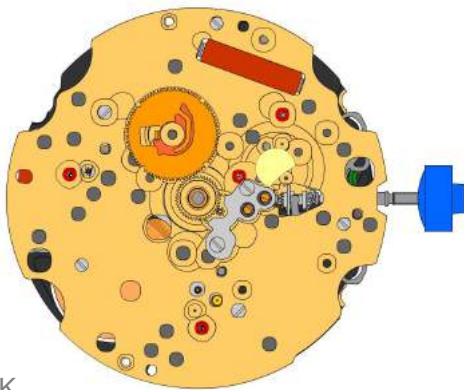
 3007.078.CO
58.  Wechselrad

K

 2130.177
59.  Wechselradbrücke
Wechselradbrücke gehalten durch 2 Schrauben 4000.319.

 4000.319
60.  Schraube

 3301.247
61.  Stundenrad (Aig.3)

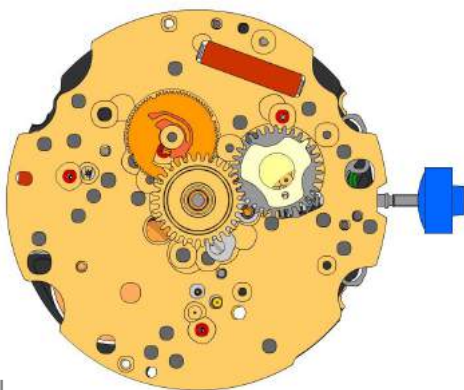
 3004.171.CO
62.  Datumanzeiger-Mitnehmerrad

L

 3004.173
63.  Monatsmitnehmerrad

 3004.174
64.  Monatsfinger
Die unterseitigen Erhöhungen des Monatsfingers greifen in die beiden Aussparungen des Monat-Mitnehmerrades ein.



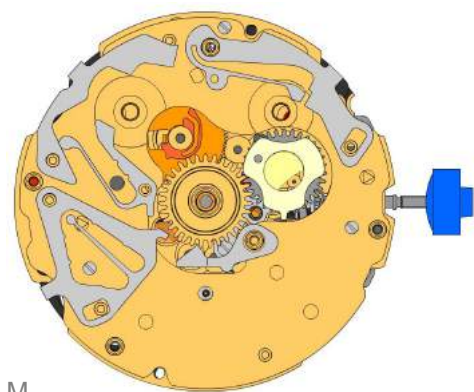



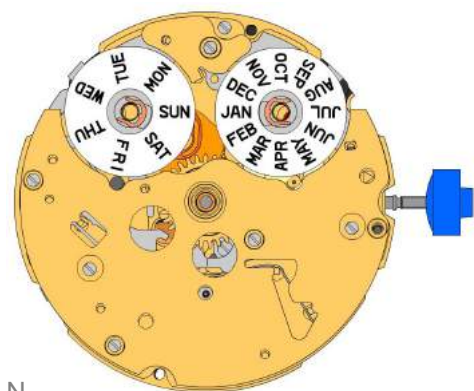







 3301.248
65.  Datumanzeigerrad







M



N

2130.155.CO 66.		Datumsplatte Datumsplatte gehalten durch 3 Schrauben 4000.282.
4000.282 67.		Schraube
3507.054 68.		Monatskorrektor
3507.055 69.		Tageskorrektor
3507.056 70.		Datumskorrektor
3500.053 71.		Tagesraste
3500.065 72.		Datumsraste
2130.157.G 73.		Kombinierte Halteplatte Kombinierte Halteplatte gehalten durch 4 Schrauben 4000.286.
4000.286 74.		Schraube
2130.166.G 75.		Korrektor-Halteplatte Korrektor-Halteplatte gehalten durch 1 Schraube 4000.286.
4000.286 76.		Schraube
3905.059 77.		Feder für Datumsraste Feder für Datumsraste in die Öffnung einfügen.
3508.153.AA.E.A 78.		Tagesanzeiger (Standard)
3508.154.AE.E.A 79.		Monatsanzeiger (Standard)
3909.028 80.		Kupplungstriebhebelfeder
3909.028 81.		Kupplungstriebhebelfeder

8200 82.		Moebius 8200
9014 83.		Moebius 9014
124 84.		Jismaa 124
9020 85.		Moebius 9020

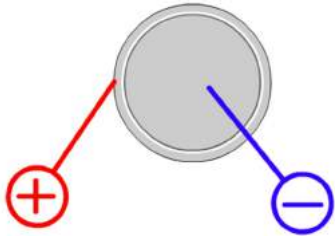

Batterie	395
Spannung	1.55 V

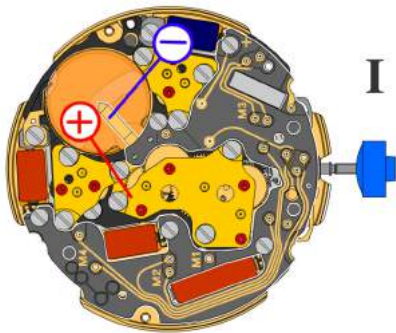

*Stellwelle in Position I, Kalender nicht im Eingriff,
60 s Messintervall für Gang und Verbrauch:*

Typischer Verbrauch	1.32 μA
Maximaler Verbrauch	1.65 μA
Gang	-10s/M. .. +20s/M.
Untere Funktionsspannungsgrenze	1.20 V

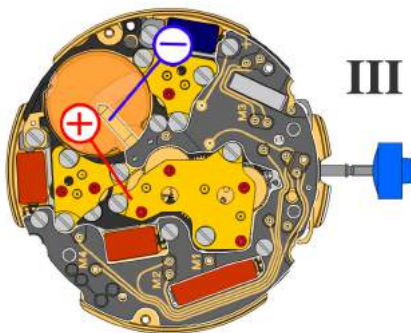

Stellwelle in Position III, 60 s Messintervall:

Typischer Verbrauch	0.10 μA
Maximaler Verbrauch	0.30 μA

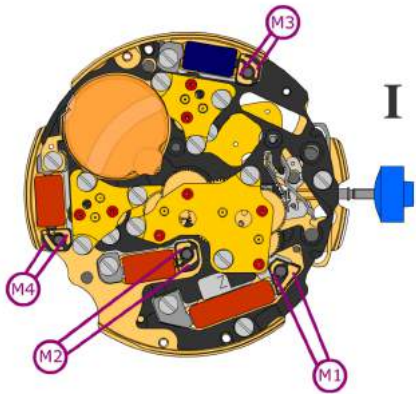

Spulenwiderstand M1 **1.90 k Ω .. 2.10 k Ω**

Spulenwiderstand M2 **1.68 k Ω .. 1.88 k Ω**

Spulenwiderstand M3 **1.68 k Ω .. 1.88 k Ω**

Spulenwiderstand M4 **1.68 k Ω .. 1.88 k Ω**

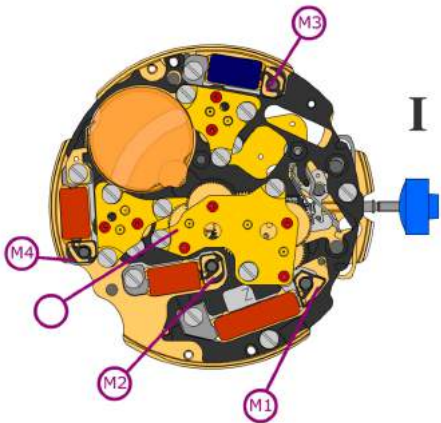

Spulenisolation M1/M2/M3/M4 **∞ k Ω**

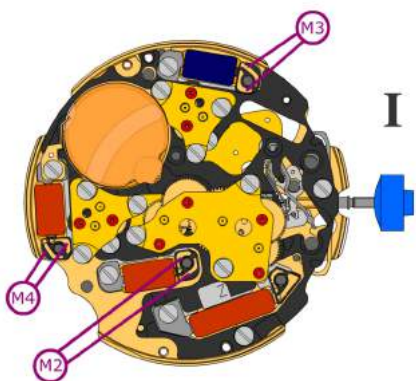

Pulsgenerator (4.9 ms, 8 Hz):

Untere Funktionsspannungsgrenze M2/M3/M4 **1.20 V**